



BOUW- BOEK

Uw partner voor op de bouwplaats

**READY
FOR WORK**



BOUWBOEK

Dit Bouwboek bevat een basispakket producten voor de bouw die Würth u kan leveren. In dit boek staan een aantal veel voorkomende artikelen uit het omvangrijke pakket van Würth. Naast een afbeelding, korte beschrijving en typenummer van de besproken artikelen staan in dit boek ook alle bijbehorende barcodes.



Voor uitvoerige productinfo hebben we een groot aantal mogelijkheden:

De vertegenwoordiger van Würth kan u adviseren bij aanschaf van producten. Onze Würth Online-Shop bevat van bijna alle Würth artikelen informatiebladen, hierin staat informatie over het product en de toepassing ervan. Productinformatie kunt u ook opvragen vanuit uw smartphone met onze Würth App. Daarnaast hebben we voor specifieke artikelen en artikelgroepen brochures.

Het Bouwboek is vooral bedoeld als hulpmiddel bij uw (digitale) bestellingen.

Wanneer u zich heeft geregistreerd bij Würth voor gebruik van de Würth Online-Shop kunt u direct de juiste artikelen bestellen. Door het scannen van de barcode weet u zeker dat u het door u gekozen product zult ontvangen.

Door het enorme aanbod van artikelen in het Würth pakket is het niet mogelijk om alle barcodes in dit boek op te nemen. Om toch ook deze artikelen snel te kunnen vinden hebben we het juiste voornummer van deze artikelen opgenomen. In de Würth Online-Shop zult u daardoor nog sneller het juiste artikel kunnen vinden. Uiteraard zal uw Würth vertegenwoordiger u op weg helpen met het gebruik van onze Würth Online-Shop.

Würth Online-Shop met meer dan 100.000 artikelen

De Würth website is ontworpen om u zoveel mogelijk te ondersteunen in uw dagelijkse werkzaamheden. Met behulp van de Würth Online-Shop kunt u artikelen bestellen, orders, offertes en opdrachten inzien, levertijden achterhalen, uw facturen raadplegen en nog veel meer.

Voordelen Würth Online-Shop:

- eenvoudig artikelen zoeken en bestellen
- snel vinden en bekijken van cataloguspagina's
- uitgebreide productinformatie, veiligheidsinformatiebladen
- actuele prijzen en aanbiedingen, uw condities direct beschikbaar
- vele instellingen zijn mogelijk voor gebruikers, zoals budget, kostenbeheer en kostenplaatsen
- 7 dagen per week, 24 uur per dag beschikbaar
- koppeling met uw eigen softwarepakket mogelijk



INDEX

- 6 Koffie, thee en schoonmaak
- 10 Wegbebakening
- 14 Bouwmaterialen
- 26 Kabels & verlichting
- 28 Kabels & waterslangen
- 30 Waterslangkoppelingen
- 32 Markeerverf, verf & krijt
- 34 Potloden, meetgereedschap & batterijen
- 36 Meetgereedschap
- 38 Hamerboren
- 44 Machinebeitels
- 46 Diamantzaagbladen
- 48 Metaalboren
- 52 Slijpschijven & afbraamschijven
- 54 Speedboren of vlinderboren
- 56 Gatzagen
- 60 Decoupeerzaagbladen
- 60 Schrobzaagbladen/reciprozagen
- 64 Cirkelzaagbladen
- 66 Bitjes & bithouders
- 70 Handgereedschap schroevendraaiers
- 72 Handgereedschap dopsleutelsets & steeksleutels
- 74 Handgereedschap ringsteeksleutels, stiftsleutels & tangen
- 76 Handgereedschap handzagen & ijzerzagen
- 78 Handgereedschap hamers & mokers
- 80 Handgereedschap beitels
- 82 Handgereedschap messen
- 86 Lasers
- 88 Elektrisch gereedschap
- 90 Accu gereedschap
- 92 Stofafzuiging
- 94 Gereedschapstas & koffers
- 96 Hamertackers
- 97 Geschoten techniek gasschiethamers
- 98 Spijkers & nagels
- 100 Bouwlocatie logistiek
- 101 Zeskantbouten & metaalschroeven
- 102 Draadeinden, ringen & moeren
- 104 Boorschroeven, PIAS®
- 105 Spaanplaatschroeven VZ
- 108 Spaanplaatschroeven RVS
- 111 Spaanplaatschroeven TORX
- 114 Spaanplaatschroeven ASSY® 4
- 118 Spaanplaatschroeven ASSY® 4 zwart
- 120 Spaanplaatschroeven RVS ASSY® 4
- 122 Hardhoutschroeven RVS ASSY® 4
- 124 Houtschroeven ASSY® 4
- 125 Houtdraadbouten & slotbouten
- 128 Snelbouwschroeven / snelschroeven
- 130 Afstandsmontageschroeven
- 131 Kunststof kozijnpluggen
- 132 Slagpluggen
- 134 Pluggen & FIX huls
- 136 Projectadvies
- 138 Schroefankers
- 140 Ankers mechanisch
- 141 Ankers chemische verankering
- 144 Installatietechniek
- 148 Lijmen & kitten
- 151 PUR, PURcleaner & PURpistolen
- 152 Chemie
- 154 ISII! Gevaarstofmanagement
- 156 Tape
- 158 Tape & kwasten
- 160 Verf, plamuur & kwasten
- 162 Kabelbandjes / bundelbandjes
- 164 Uitvul- & drukplaten / stelwiggen
- 166 Eenhand- en schroefklemmen, uitvulplaatjes & touw
- 168 Ruwbouw & veiligheid
- 169 Element- & kozijnverbindingen
- 171 Spouwankers & isolatiebevestiging
- 172 Rocketclip-houtgevelsysteem
- 174 Houtverbindingen
- 175 Luchtdicht bouwen, raam- en deurkozijnen & bouwaansluitingen
- 180 Luchtdicht bouwen Binnenzijde folies
- 182 Luchtdicht bouwen Dak-, Gevel- en Wandfolies
- 186 Luchtdicht bouwen toebehoren
- 187 Waterkering
- 190 Brandwerende systemen
- 192 Ladders & trappen
- 193 Valbeveiliging
- 196 Handschoenen
- 200 Oordopjes & veiligheidsbrillen
- 202 Stofmaskers, helmen & oorkappen
- 204 Veiligheid, EHBO en anti-gladheid
- 206 Poetspapier, papierrollen & handdoekrollen
- 208 Houders voor papier, poetsdoeken en zeep
- 210 Kleding
- 216 Schoenen & laarzen
- 218 Bedrijfswagens

WÜRTH BARCODE KEETBENODIGDHEDEN

 089090090 VE 1 Universele reinigingsdoek UNIV. REINIGINGSDOEKJES 90 STUKS	
 0899900250 VE 72 3-laags toiletpapier TOILETPAPIER 3-LAAGS WIT 250 VEL	
 0993997125 VE 1 Toiletborstel TOILBRSH-(IN POT)	
 9501008096 VE 24 Frisdranken in fles of blik COCA-COLA-ZERO-33CL-BLIK	
 9501008098 VE 24 Frisdranken in fles of blik SPA-REINE-BLAUW-50CL-PET	
 9501008102 VE 24 Frisdranken in fles of blik ICE-TEA-SPARKLING-33CL-BLIK	
 9501008104 VE 1 Koffie De Aroma Rood 500gr DE-AROMA-ROOD-SNELF-500GR	
 9501008106 VE 21 Snacks Zoet of hartig CUP-A-SOUP-175ML-TOMAAT	
 9501008108 VE 21 Snacks Zoet of hartig CUP-A-SOUP-175ML-GROENTE	
 9501008110 VE 20 Snacks Zoet of hartig SNELLE-JELLE-KRUIDKOEK-65G	

 0899700400 VE 1 Autospons AUTOSPONS	
 0993997018 VE 1 Prullenbak WASTECAN-PLA-18LTR	
 9501008095 VE 24 Frisdranken in fles of blik COCA-COLA-REGULAR-33CL-BLIK	
 9501008097 VE 24 Frisdranken in fles of blik SPA-INTENSE-50-CL-PET	
 9501008099 VE 24 Frisdranken in fles of blik FANTA-ORANGE-33CL-BLIK	
 9501008101 VE 6 Frisdranken in fles of blik BAR-LE DUC-MINER-WATER-2LT-PAK	
 9501008103 VE 24 Frisdranken in fles of blik SPRITE-REFRESH-33CL-BLIK	
 9501008105 VE 40 Snacks Zoet of hartig BIFI-ORIGINAL-40-X-22,5G	
 9501008107 VE 21 Snacks Zoet of hartig CUP-A-SOUP-175ML-KIP	
 9501008109 VE 21 Snacks Zoet of hartig CUP-A-SOUP-175ML-CHAMPIGNON	
 9501008119 VE 1 Roerstaafjes Hout ROERSTAAFJE-HOUT-140MM-12000ST	

KEETBENODIGDHEDEN

Schoonmaakdoekjes

Wet wipes 90 stuks

Art.nr. 0890 900 90

VE/st. 1



Spons

Art.nr. 0899 700 400

VE/st. 1



Prullenbak

18 liter

Art.nr. 0993 997 018

VE/st. 1



Toiletpapier/wc-papier

72 rol - 3 laags

Art.nr. 0899 900 250

VE/st. 72



Toiletborstel

Art.nr. 0993 997 125

VE/st. 1



Roerstaafjes hout

Art.nr. 9501 008 119

VE/st. 1

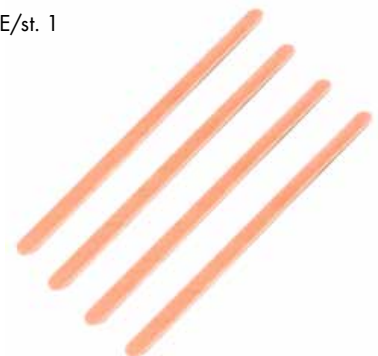

Frisdranken

Art.nr. 9501 008 ...



Snacks

Art.nr. 9501 008 ...

VE/st. 1



Koffie

Art.nr. 9501 008 104

VE/st. 1



WÜRTH BARCODE KEETBENODIGDHEDEN



9501008120 VE 5
Papier DIN A4
DOUBLE-A-PAPIER-A4-80GR-500VEL



9501008127 VE 8
Luchtverfrisser Lavendel
LUCHTVERFRISSE-LAVENDEL-8X



9501008138 VE 9
Koffiefilter 1 x 4 wit 100 filters
MELITTA-FILTERZAKJES-NR-4-80ST



9501008140 VE 1
Vaatwasmachinetabletten Verschillende me..
SUN-ALL-IN-ONE-TABLET-200ST



9501008142 VE 1
Vaatwasmiddel Verschillende merken
DREFT-ORIGINAL-340ML



9501008144 VE 3
Toiletreiniger Glorix original
GLORIX-ORIGINAL-24H-750ML



9501008147 VE 1
Allesreiniger
ANDY-ALLESREINIG.-VERTROUWD-1L



9501008149 VE 1
Koffiecapsule De caps Lungo Original
DE-CAPS-LUNGO-ORIGINAL-20ST



9501008151 VE 1
Toiletreiniger Glorix original
GLORIX-PROF.O2-5LT



0WGE4003 VE 1000
Suikersticks
WURTH-SUIKERSTICKS-5GR



9501008121 VE 3
Print papier A3
DATACOPY-PRINTPAPIER-A3-3X80GR



9501008135 VE 1
Thee Verschillende merken
PICKWICK-ENGELS-100X2GR



9501008139 VE 1
Koffie pads Senseo classic
SENSEO-CLASSIC-48PAD



9501008141 VE 1
Vaatwasmiddel Verschillende merken
CLEANIQ-AFWASMIDDEL-1L



9501008143 VE 1
Creamersticks Verschillende merken
COMPLETA-6X200GR-POT



9501008146 VE 6
Handzeep Unicura, mild
UNICURA-HANDZEEP-MILD-POMP



9501008148 VE 1
Koffiebeker Karton
NESCAFE-BEKER-KART.-180ML-2800



9501008150 VE 1
Prullenbak met vlamdovende deksel
RONDO-VLAMDOVENDE-PAPIERB-50LT



9501008235 VE 1
Glasreiniger
GLASSEX-GLAS-&-MULTIREINIGER



0WGE4004 VE 1000
Koffiecreamer in sticks of pot
WURTH-CREAMERSTICKS-2,5GR



KEETBENODIGDHEDEN

Koffiebekers

karton

Art.nr. 9501 008 148
VE/st. 1
(= 2800 bekers)



Koffie & thee

Art.nr. 9501 008 ...



Suiker

Art.nr. OWGE 400 3
VE/st. 1.000

Creamer/melk

Art.nr. OWGE 400 4
VE/st. 1.000



Prullenbak

met vlamdovend deksel

Art.nr. 9501 008 150
VE/st. 1



Schoonmaakmiddelen

Art.nr. 9501 008 14.



Papier

A4 - A3

Art.nr. 9501 008 12.
VE/st. 5/3



WÜRTH BARCODE WEGBEBAKENING

 0827000001 VE 1
 Blokbatterij
 BLOKBATTERIJ 4R25 6V



 0993899301 VE 1
 Waarschuwings- en markeringslamp
 WAARSCHUWINGSLAMP-GEEL-V.GELEIDBAKE



 0993899303 VE 1
 Begrenzer
 GELEIDEBAKEN-RA1-PIJLFOLIE



 0993899305 VE 1
 Valbeveiligers
 AFZETHEK-RA1



 0827830004 VE 3
 Lampsleutel
 LAMP-BOUWPLAATS-SLEUTEL



 0993899302 VE 1
 Begrenzer
 GELEIDEBAKEN-RA1-STREEPFOLIE



 0993899304 VE 1
 Boldervoet
 VOETPLAAT-V.GLDBKN-AFZETHEK



 0993899307 VE 1
 Markeringskegel
 VERKEERSKEGEL-750MM



 0993899306 VE 1
 Markeringskegel Twee delen
 VERKEERSKEGEL-500MM



 0993899500 VE 1
 Markeringskegel
 VERKEERSKEGEL-ROODWIT-DAYLIMINOUS-500MM



Verkeerskegel, oranje (briljantrood)

Met 2 witte niet-reflecterende strepen

Hoogte: 500 mm

Art.nr. 0993 899 500

VE/stuk 1



Verkeerskegel twee delen

Hoge mate van stabiliteit dankzij anti-tiprand

Hoogte: 500 mm

Art.nr. 0993 899 306

VE/stuk 1



WEGBEBAKENING



Markeringskegel

Tijdelijke markeringskegel met uitstekende stabiliteit, goedgekeurd voor gebruik op wegen

Hoogte: 750 mm
Lengte x breedte: 445 x 445 mm
Kleur: Wit, Rood

Art.nr. 0993 899 307

VE/stuk 1



Geleidebaken

Folietype	RA1/A	
L x B x H	1320 x 295 x 55 mm	

Art.nr.	0993 899 302	0993 899 303
VE/stuk	1	1



Voetplaat geleidebaken/afzethek



Art.nr. 0993 899 304

VE/stuk 1



Waarschuwings- en markeringslamp

BASt-geteste lamp met onbreekbare behuizing en comfortabel handvat

Art.nr. 0993 899 301

VE/stuk 1

Lampsleutel

Voor LED Euro waarschuwinglamp en LED-waarschuwinglamp

Art.nr. 0827 830 004

VE/stuk 1



Afzethek

BASt-geteste valbeveiliging voor o.a. graafwerk

Kleur: Wit, Rood
Hoogte: 1110 mm
Lengte: 2150 mm

Art.nr. 0993 899 305

VE/stuk 1

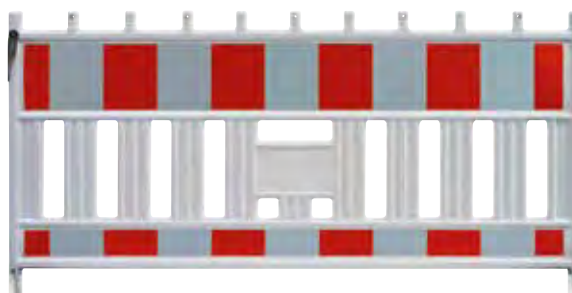

Blokbatteij

Voor LED-waarschuwinglamp

Art.nr. 0827 000 001

VE/stuk 1



WÜRTH BARCODE WEGBEBAKENING



0899604003 VE 5
 Verbodsticker VERBODEN TOEGANG VOOR
 VERBODEN TOEGANG VOOR ONBEVOEGDEN



0899605021 VE 5
 Waarschuwingsticker GEVAAR VOOR ONT
 GEVAAR VOOR ONTVLAMBARE STOFFEN



0899610812 VE 1
 Kunststofketting
 KUSTSTKETTING-PP-ROOD/WIT-8MM-25M



0899615009 VE 1
 Afzetlint Gemaakt van duurzaam regranulaat
 AFZETLINT-ROOD/WIT-BLUEANGEL-80MMX500M



0899605001 VE 5
 Gebodstickers VEILIGHEIDSHELM VERPL
 VEILIGHEIDSHELM VERPLICHT



0899610612 VE 1
 Kunststofketting
 KUNSTSTOFKETTING-PP-ROOD/WIT-6MM-25M



0899615000 VE 1
 Dispenser
 AFROLBOX VOOR AFZETLINT



0993997033 VE 1
 Markeerbout
 SECSTAK-RED-1250MM



WEGBEBAKENING

Bevestigingspaal voor afzetlint

Lengte: 1,25 m
Diameter: 13 mm

Art.nr. 0993 997 033

VE/stuk 1



Kunststofketting

Voor afzetten, beveiligen en gebruik als regenketting

Diameter: 6 mm
Kleur: Rood/wit
Lengte: 25 m

Art.nr. 0899 610 612

VE/stuk 1

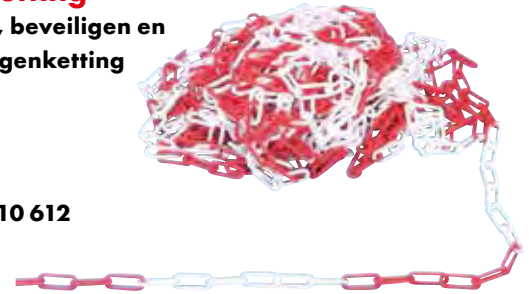

Afzetlint

Voor afsluiten, beveiligen en markeren van gevarenzones, bouwplaatsen, bouwputten, kavels, paden, enz.

Breedte: 80 mm
Lengte: 500 m

Gemaakt van duurzaam regranulaat

Art.nr. 0899 615 009

VE/st. 1



Dispenser

Lege roldispenser voor afzetlint

Art.nr. 0899 615 000

VE/stuk 1

Verbodssticker

**VERBODEN TOEGANG
VOOR ONBEVOEGDEN**
volgens ISO 7010

Art.nr. 0899 604 003

VE/stuk 5



Waarschuingssticker

**GEVAAR VOOR
ONTVLAMBARE STOFFEN**
volgens ISO 7010

Lengte: 200 mm
Breedte: 200 mm

Art.nr. 0899 605 021

VE/stuk 5



Gebodsstickers

VEILIGHEIDSHELM VERPLICHT
volgens ISO 7010

Kleur: Blauw, Wit

Art.nr. 0899 605 001

VE/stuk 5



WÜRTH BARCODE AFVALZAKKEN & SLOTEN

<p>0688904030 VE 1 Hangslot Magno HANGSLOT VAN MESSING 30 mm</p>	<p>0688904040 VE 1 Hangslot Magno HANGSLOT 40 mm</p>
<p>0688904050 VE 1 Hangslot Magno HANGSLOT 50 mm</p>	<p>0688904060 VE 1 Hangslot Magno HANGSLOT MAGNO 60 mm</p>
<p>0688904800 VE 1 Hangslot Diskus -DISCUS-A2- 70 mm</p>	<p>0688906829 VE 1 Vierkante beveiligingsketting VIERK KETTING GEHARD ST VZ 1500 mm</p>
<p>0899800555 VE 15 Afvalzak VUILNISZAKKEN EXTRA STERK 700X1100X0,07</p>	<p>0899800550 VE 25 Afvalzak VUILNISZAK STERK 700X1100X0,04 BLAUW</p>
<p>0993000138 VE 1 Vloermat kokos FLRMAT-COCO-390X590MM</p>	<p>0899800559 VE 20 Afvalzak, andere NON-KOMO VUILNISZAK GRIJS 600X800MM</p>
<p>0893322010 VE 1 Sproei schuimblusser ABF BRANDBLUSSER-2L-SCHUIM</p>	<p>0899800600 VE 100 Puinzak PE PUINZAKKEN-50X70CM-TRANSPARANT</p>
<p>0899801000 VE 15 Big bag Standaard BIG-BAG-90X90X110CM-1200KG</p>	

BOUWMATERIALEN AFVALZAKKEN & SLOTEN

Afvalzakken/ vuilniszakken

Grijs, 60 x 80 cm, NON-KOMO

Art.nr. 0899 800 559

VE/st. 20



Afvalzakken

Blauw, 70 x 110 cm

Sterk

Art.nr. 0899 800 550

VE/st. 25

Extra sterk

Art.nr. 0899 800 555

VE/st. 15



Puinzakken

Transparant

50 x 70 cm

Art.nr. 0899 800 600

VE/st. 100

Scheurvast

65 x 100 cm

Art.nr. NB05 800 650

VE/st. 136



Hangslot Magno

30/40/50/60 mm

Art.nr.

0688 904 0.. (maat)

VE/st. 1



Schuimblusser

SD2F, 2kg

Art.nr. 0893 322 010

VE/st. 1



Big Bag standaard

- Met zoom en binders
- Met vier draaglusen (lengte: 25 cm)
- Draaglast (SWL): 1.200 kg
- Veiligheidsfactor (SF): 5:1
- Stofdikte: 150 g/m²
- Zonder opdruk

Art.nr. 0899 801 000

VE/st. 15



Hangslot Diskus

RVS, 70 mm

Art.nr. 0688 904 800

VE/st. 1



Beveiligingsketting

Vierkante schakels, gehard 150 cm

Art.nr. 0688 906 829

VE/st. 1



Vloermat kokos

59 x 39 cm

Art.nr. 0993 000 138

VE/st. 1



WÜRTH BARCODE SCHOPPEN & DEKZEILEN



9501015767 VE 1
Dekzeil met ogen
DEKZEIL-PP-AFM-4X6M-ORANJE



9501015769 VE 1
Dekzeil met ogen
DEKZEIL-PP-AFM-8X10M-ORANJE



0695943057 VE 1
Schraper
KRABBER, 300MM



071370 063 VE 1
Metseldraad, polyethyleen
KOORD VOOR METSELAAR, 1, 7MM



071370 053 VE 5
Metseldraad, polypropyleen
METSELKOORD-PP-50M



9501015768 VE 1
Dekzeil met ogen
DEKZEIL-PP-AFM-6X8M-ORANJE



0695943030 VE 1
Bouwspade
STEEKSCHOP



0715735013 VE 1
Schrapersteel
KRABBERSTEEL



071370 066 VE 1
Metseldraad, polypropyleen
KOORD VOOR METSELAAR, 2MM



BOUWMATERIALEN SCHOPPEN & DEKZEILEN

Spade/steekschop

T-greep en voettrede

Art.nr. 0695 943 030

Met steel

VE/st. 1



Dekkleed

PE, oranje

4 x 6 meter

Art.nr. 9501 015 767 VE/st. 1

6 x 8 meter

Art.nr. 9501 015 768 VE/st. 1

8 x 10 meter

Art.nr. 9501 015 769 VE/st. 1



Schraper

Art.nr. 0695 943 057

VE/st. 1



Metseldraad

Koord voor metselaar, 1,7 mm

Art.nr. 0713 70 063

Art.nr. 0713 70 066

VE/st. 1



Metselkoord

Art.nr. 0713 70 053

VE/st. 1



Schrapersteel

Art.nr. 0715 735 013

VE/st. 1



BOUWMATERIALEN AFDEKMATERIALEN

Stucloper 50M²

Kwaliteit: 280gr/m²

Breedte: 1,3 m

De LPDE laag heeft een beschermende functie tegen vocht of vloeistoffen waardoor de sterkte van het materiaal altijd gewaarborgd blijft.

Art.nr. 0899 700 250

VE/st. 1 rol



0899700250 VE 1
Stucloper 50m² Würth
WURTH-STUCLOPER-280GR-PE-B1,3M-50M²



Zelfklevend afdekvlies

Wit zelfklevend afdekvlies voor visueel hoogwaardige bedekkingen

- Lichtgewicht
- Vloeistofdichtheid
- Antislip laag
- Rolbreedte 1 m
- Basisgewicht per m²: 170 g

Rollengte 25 m

Art.nr. 0818 050 250

VE/st. 1 rol

Rollengte 50 m

Art.nr. 0818 050 500

VE/st. 1 rol

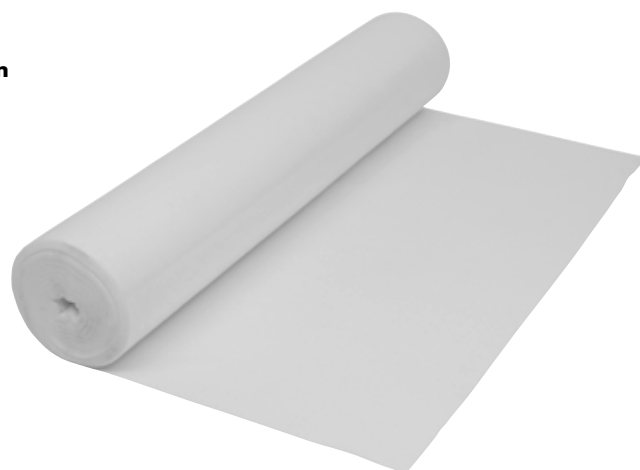

0818050250 VE 1
Zelfklevende afdekvlies
ZELFKLEVEND-AFDEKVLIES-170GR-B1,0M-L25M



0818050500 VE 1
Zelfklevende afdekvlies
ZELFKLEVEND-AFDEKVLIES-170GR-B1,0M-L50M



Afdekvlies 1 m x 50 m

Universele bescherming voor vloeren tijdens schilder- en renovatiewerkzaamheden

Light - eenmalig gebruik

Kwaliteit: 200gr/m²

Art.nr. 0818 050 090

VE/st. 1 rol

Strong - herbruikbaar

Kwaliteit: 275gr/m²

Art.nr. 0818 050 100

VE/st. 1 rol



0818050090 VE 50
Afdekvlies light
AFDEKVLIES



0818050100 VE 50
Afdekvlies strong
AFDEKVLIES 1 METER BREED



BOUWMATERIALEN **AFDEKMATERIALEN**

Ademvlies 1 m x 25 m

De oplossing voor vloeren die nog moeten drogen, uitharden of ademen. Wanneer pas gelegde of vers verlijmde vloeren niet kunnen uitharden of ademen, ontstaat er kristallisatie. Er kan kleurverschil of onthechting ontstaan. Ademvlies biedt hiervoor een uitstekende bescherming.



Art.nr. 0818 050 251
VE/rol 1

0818050251 VE 1
Ademende beschermfolie
ZELFKLEVEND-ADEMVLIES-B1,0M-L25M

Zelfklevende beschermfolie

Voor harde en zachte ondergronden

Rolbreedte: 70 cm
Rollengte: 60 m
Dikte: 75 µm

Harde ondergrond
Art.nr. 0818 050 255
VE/st. 1 rol

Zachte ondergrond
Art.nr. 0818 050 256
VE/st. 1 rol



0818050255 VE 1
Afdekvlies trap
ZELFKLEVEND-BESCHERMFOLIE-HARD-B70CM-60M

0818050256 VE 1
Afdekvlies trap
ZELFKLEVEND-BESCHERMFOLIE-SOFT-B70CM-60M

Klusdoek 1x1 m

- Absorberend
- Vloeistofdicht
- Antislip onderlaag

Art.nr. 0818 050 260
VE/st 1 bundel (= 10 stuks)



0818050260 VE 1
Afdekvlies strong
KLUSDOEK-10STUKS-220GR-B100CM-L100CM

WÜRTH BARCODE VEGERS



0695943963 VE 1
Straatbezem
STRAATBEZEM ELASTON, 400MM



0695944005 VE 1
Veegblik
STOFBLIK METAAL ORANJE UIT 1 DEEL



0695943972 VE 1
Industriële bezem, kokos
ZAALBEZEM-KOKOS-L600MM



0715735021 VE 1
Ronde houten steel
STEEL-23,5X1400MM

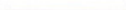

0695944400 VE 1
Industriële bezem Elaston
ZAALBEZEM-ELASTON-L400MM



0695944401 VE 1
Industriële bezem Elaston Voor grof stof e...
ZAALBEZEM-ELASTON-L600MM



0695943966 VE 1
Straatbezem, Piassava
STRAATBEZEM-PIASSAVA-L400MM



0695943969 VE 1
Straatbezem
STRAATBEZEM ELASTON, 600MM



0695943971 VE 1
Veegblik
VUILNISBLIK



0695943999 VE 1
Handveger, andere
VEGER EN BLIK KUNSTSTOF



0715735017 VE 1
Apparaathandgreep conisch
BEZEMSTEEL



0715735033 VE 1
Houten steel, conisch Met geslepen kegel ...
STEEL-CONISCH-D28-L1600MM



0695943970 VE 1
Handborstel, kokosnoot Voor fijnstof binnen
HANDVEGER-KOKOS-L280MM



BOUWMATERIALEN VEGERS

Wegenbouwbezem 45 cm

Bassine haren 11 cm (palmvezel)

Art.nr. 0695 943 966

Zonder steel

VE/st. 1



Steel voor wegenbouwbezem, 28,5 mm

Art.nr. 0715 735 033

VE/st. 1

Wegenbouwbezem breed

Kunstvezel Elaston donkerrood

40 cm (zonder steel)

Art.nr. 0695 943 963 VE/st. 1

60 cm (zonder steel)

Art.nr. 0695 943 969 VE/st. 1



Steel dik conisch, 28 mm

Art.nr. 0715 735 017

VE/st. 1

Zaalveger kokos 50 cm

Rond, kokosharen

Art.nr. 0695 943 972

VE/st. 1



Steel voor zaalveger, 23,5 mm

Art.nr. 0715 735 021

VE/st. 1

Stadsbezem

Kunstvezel haren rood

40 cm (zonder steel)

Art.nr. 0695 944 400 VE/st. 1

60 cm

Art.nr. 0695 944 401 VE/st. 1



Steel voor stadsbezem, 23,5 mm

Art.nr. 0715 735 021

VE/st. 1

Handveger

Art.nr. 0695 943 970

VE/st. 1



Stofblik

Metaal, zwart

Art.nr. 0695 943 971

VE/st. 1



Stoffer en blik

Plastic

Art.nr. 0695 943 999

VE/st. 1



Stofblik

Metaal, oranje

Art.nr. 0695 944 005

VE/st. 1



WÜRTH BARCODE EMMERS & POMPEN

<p>0651150207 VE 1 Bekistingsoliespuit HOGEDRUKSPUIT 10L OLIEBESTENDIG UITV</p>	
<p>069577012 VE 5 Bouwemmer BOUWEMMER, 12L</p>	
<p>069594332 VE 1 Rubberen wissers RUBBEREN WISSER, 45CM</p>	
<p>0715735021 VE 1 Bezemsteel/trekkersteel BEZEM-/RUBBEREN WISSERSTEEL-23,5X1400MM</p>	
<p>0993997022 VE 1 Speciekuip, vierkant MORTBCKT-SQUAR-BLACK-65LTR</p>	
<p>0993997025 VE 1 Speciebak, rond SPECIEKUIP ZWART 65LTR</p>	
<p>0688190200 VE 1 Montagesleutel Zinkspuitgietswerk NIEUWBOUWSLEUTEL STAAL</p>	
<p>071516 23 VE 1 Universele 5-in-1 schakelkast sleutel SLTL-SCHAKELKAST-UNI-9IN1-96X92MM</p>	

<p>0651150209 VE 1 Bekistingsoliespuit HOGEDRUKSPUIT OLIEBESTENDIG-5L</p>	
<p>069577020 VE 1 Bouwemmer BOUWEMMER, 20L</p>	
<p>069594333 VE 1 Rubberen wissers RUBBEREN WISSER, 60CM</p>	
<p>0993997021 VE 1 Speciebak, rond MORTBCKT-ROUND-BLACK-90LTR</p>	
<p>0993997023 VE 1 Speciekuip, vierkant MORTBCKT-SQUAR-BLACK-90LTR</p>	
<p>099370260 VE 1 Dompelpomp Type HS DOMPELPOMP-HS</p>	
<p>0688190201 VE 1 Meetsleutel profielcilinder Type C NIEUWBOUWSLEUTEL EL KUNSTSTOF</p>	

(NIEUWBOUW) SLEUTELS



**Profielcilinder
meetsleutel**

Kunststof
Art.nr. 0688 190 201
VE/st. 1



Montagesleutel

Staal
Art.nr. 0688 190 200
VE/st. 1



Schakelkast sleutel

Art.nr. 0715 16 23
VE/st. 1

BOUWMATERIALEN EMMERS & POMPEN

Drukspuit voor be- of ontkistingsolie

10 liter
 Art.nr. 0651 150 207 VE/st. 1
6 liter
 Art.nr. 0651 150 209 VE/st. 1



Dompelpomp TYPE HS

Art.nr. 0993 702 60
 VE/st. 1



Bouwemmer

12 liter
 Art.nr. 0695 770 12
 VE/st. 1
20 liter
 Art.nr. 0695 770 20
 VE/st. 1



Vloertrekker/ rubberen wisser

Metaal/rubber

45 cm breed
 Art.nr. 0695 943 32 VE/st. 1
60 cm breed
 Art.nr. 0695 943 33 VE/st. 1



Steel Ø 24 mm
 Art.nr. 0715 735 021
 VE/st. 1

Speciekuip rond

65 liter
 Art.nr. 0993 997 025 VE/st. 1
90 liter
 Art.nr. 0993 997 021 VE/st. 1

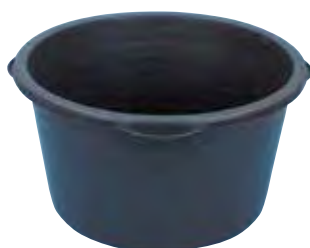













Speciekuip rechthoek

65 liter
 Art.nr. 0993 997 022 VE/st. 1
90 liter
 Art.nr. 0993 997 023 VE/st. 1



WÜRTH BARCODE

KRUIWAGENS & KOEVOET & BIG BAG

 4 0 3 8 8 9 8 0 3 2 9 7 7 0477140001 VE 1 Binddraadrolletjes BINDDRAADROL-EMMER-20KG-1,4		 4 0 5 0 6 4 1 6 9 5 4 6 8 0695200262 VE 1 Kruiwagen, andere STEENKRUIWAGEN	
 4 0 5 0 6 4 1 6 9 4 4 2 3 0695200263 VE 1 Kruiwagen, andere UNIVERSELE KRUIWAGEN		 4 0 5 0 6 4 1 6 9 4 4 4 7 0695200264 VE 1 Kruiwagen, andere GEREEDSCHAP KRUIWAGEN	
 4 0 5 2 7 1 2 8 1 9 3 3 9 0695200270 VE 1 Kruiwagen, reserveonderdelen, andere LEKVRIJ WIEL TBV KRUIWAGEN		 4 0 4 7 3 7 6 3 8 5 0 5 0714631080 VE 1 Koevoet NAGELIJZER, 800MM	
 4 0 1 1 2 3 1 7 2 0 2 3 6 071463 47 VE 1 Breekijzer NAGELIJZER, 600MM		 4 0 3 3 4 7 9 2 6 8 4 6 0 0899801001 VE 15 Big bag, asbest BIG-BAG-ASBEST-90X90X110CM	
 8 7 1 4 3 1 8 0 1 8 4 1 2 9501000464 VE 1 Koevoet Met klauw en beitel KOEVOET-1000MM-D25-99700		 4 0 5 0 6 4 1 8 6 1 2 8 3 0962500102 VE 1 Hellingrooster HELROOSTER-(ZN)-2000X600X40MM-200KG	
 8 7 1 4 3 1 8 0 1 8 4 3 6 9501000466 VE 1 Stootijzer Met knop en beitel STOOTIJZER-1000MM-D25-99702		 4 0 5 5 3 7 4 1 5 0 6 6 6 NB05800150 VE 1 Afvalzak, plastic, andere BIG BAG 91X91X115CM 1500KG	

Hellingrooster

Dubbel gecoat

Breedte	600 mm
Draagvermogen	200 kg
Materiaal	Staal, speciaal gehard
Oppervlakte	Verzinkt
Art.nr.	0962 500 102
Lengte	2000 mm
VE/stuk	1



BOUWMATERIALEN

KRUIWAGENS & KOEVOET & BIG BAG

Kruiwagen

Universele bak, 80 liter

Art.nr. 0695 200 263

VE/st. 1



Steenkruiwagen

Art.nr. 0695 200 262

VE/st. 1



Gereedschap

kruiwagen

Scharnierend deksel
Afsluitbaar met hangslot

Art.nr. 0695 200 264

VE/st. 1



Lekvrije band t.b.v. kruiwagen

Ø 400 X 100 mm

Art.nr. 0695 200 270

VE/st. 1



Binddraad

Blank staal, emmer 20 kg

Art.nr. 0477 140 001

VE/st. 1



Stootijzer

1 meter lang, Ø 25 mm

Art.nr. 9501 000 464

VE/st. 1



BIG BAG

91 x 91 x 115 cm, 1500 kg

Art.nr. NB05 800 150

VE/st. 1



Model voor asbest e.a.

Art.nr. 0899 801 00..

VE/st. 1



Koevoet, klauw en beitel

1 meter lang, Ø 25 mm

Art.nr. 9501 000 466

VE/st. 1



Koevoet

60 cm lang

Art.nr. 0714 63 47

VE/st. 1



80 cm lang

Art.nr. 0714 631 080

VE/st. 1

WÜRTH BARCODE KABELS & VERLICHTING



077425 050 VE 1
Kunststof kabelhaspel, rubberen kabel H0...
KABELHASPEL 25M. RUBBER 1,5MM2



077440 050 VE 1
Kunststof kabelhaspel, rubberen kabel H0...
KABELHASPEL 40M. RUBBER 2,5MM2



0969300401 VE 1
Stekker met randaarding
RUBBERSTEKKER-250V-16A-IP54



0969303301 VE 1
Driev. verdeelbl. m. aardcont. en zelfs...
KOPPL-VOLRUBBER-3WEG-KLPDEKSEL-16A-250V



0969310002 VE 1
H07RN-F geaard verlenging
EXTLD-1WAY-(H07RN-F3G1,5)-16A-250V-20M



0827809998 VE 1
SLA LED-hoofdlamp
LED-HOOFDLAMP-SLA



0827940450 VE 1
Oplaadbare led-handlamp Ergopower Boost
ACCU HANDLAMP ERGOWPOWER BOOST



0969301401 VE 1
Contrastekker met randaarding Voor kabels ...
CONTRASTEKKER-RUBBER-RANDAARDE-16A-250V



077425 315 VE 1
Kabelhaspel rubber kabel H07RN-F
KABELHASPEL NEOPREEN 25 MTR 3X1,5



077440 325 VE 1
Kabelhaspel rubber kabel H07RN-F
KABELHASPEL NEOPREEN 40 MTR 3X2,5



0981505150 VE 1
LED bouwlamp met kabel
LED WERKLAMP 150W OP STD



0969301411 VE 1
Contrastekker met klapdeksel randaarding
RUBBERCONTRASTEK-250V-16A-IP54



0969310001 VE 1
H07RN-F geaard verlenging
VERLENGKABEL 10 M 3X1,5 IP 44 LUX



9501011154 VE 1
LED-werklamp Op accu, SMD2835
LAMP-LED-BTRIJ-217X185X315MM-20W



0827940117 VE 1
Snoerloze LED-handlamp ERGOWPOWER PEN+
LAMP-CORDL-LED-ERGOWPOWER-PEN+-USB-C



Oplaadbare LED-Handlamp ergopower boost

Art.nr. 0827 940 450

VE/st. 1



Accu LED-lamp Ergopower Pen

Art.nr. 0827 940 117

VE/st. 1



KABELS & VERLICHTING

Verlengkabel

Neopreen, 3 x 1,5 mm²

10 meter

Art.nr. 0969 310 001 VE/st. 1

20 meter

Art.nr. 0969 310 002 VE/st. 1



Stekker met randaarding

Art.nr. 0969 300 401

VE/st. 1



Contrastekker met klapdeksel randaarding

Art.nr. 0969 301 411

VE/st. 1



LED bouwlamp met kabel

150 watt

Art.nr. 0981 505 150

VE/st. 1



Kabelhaspel (H05RR-F)

Rubber

25 meter, 3 x 1,5 mm²

Art.nr. 0774 25 050 VE/st. 1

40 meter, 3 x 2,5 mm²

Art.nr. 0774 40 050 VE/st. 1



Contrastekker met randaarding voor kabels tot 3G 2,5 mm²

Art.nr. 0969 301 401

VE/st. 2



Rubber verdeelblok

Art.nr. 0969 303 301

VE/st. 1



Kabelhaspel (H07RN-F36)

Neopreen

25 meter, 3 x 1,5 mm²

Art.nr. 0774 25 315 VE/st. 1

40 meter, 3 x 2,5 mm²

Art.nr. 0774 40 325 VE/st. 1



LED-hoofdlamp SLA

Premium, 3 x AAA, 200 lumen

Art.nr. 0827 809 998

VE/st. 1



LED-werklamp op accu

Statief, accu, oplaadbaar, IP65

20 Watt

Art.nr. 9501 011 154

VE/st. 1



WÜRTH BARCODE KABELS & WATERSLANGEN



053911222 VE 50
Slangklem
SLANGKLEM-B9MM-SW7-
(12-22)



061328607 VE 1
Schroevendraaier voor zeskantkop, flexib...
SCHROEVENDRAAIER, AS, 7MM



0774762001 VE 1
Staande stroomverdeler kunststof
STAAANDE STROOMVERDELER KUNSTSTOF



0886001210 VE 50
Waterslang Professional WATERSLANG 3/4
GEEL (PER METER) **50 Meter**



0969525125 VE 1
CEE-verlengkabel
CEE-VERLENGKAB-H07RN-F5G2,5-16A-400V-25M



0969700316 VE 1
CEE-stekker 250 V/400 V, 6 H
CEE STEKKER 3POLIG 16A 230/250V



053912032 VE 50
Slangklem
SLANGKLEM-B9MM-SW7-
(20-32)



07701165 VE 50
Rubber kabel H07RN-F
ELEKTR. DRAAD FLEXIBEL ZWART 3X1,5QMM



0886001200 VE 50
Waterslang Professional WATERSLANG 1/2"
GEEL (PER METER) **50 Meter**



0969540310 VE 1
CEE-verlengkabel
CEE-VERLENGKAB-H07RN-F5G4,0-32A-400V-10M



KABELS & WATERSLANGEN

Stroomverdeler 400 Volt

1 x CEE - contactdoos 32A
 1 x CEE - contactdoos 16A
 2 x geaard stopcontact
 Neopreen, 2 meter

Art.nr. 0774 762 001

VE/st. 1



Verlengkabel

Neopreen

25 meter, 3 x 2,5 mm², 16 A

Art.nr. 0969 525 125

VE/st. 1

10 meter, 3 x 4mm², 32 A

Art.nr. 0969 540 310

VE/st. 1



Rubber kabel

Neopreen, 50 meter, 3 x 1,5 mm²

Art.nr. 0770 116 5

VE/m 50

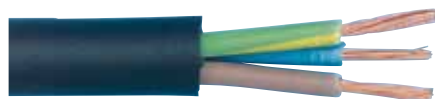

CEE stekker

250 V / 400 V

Schroefconnector, trekontlasting

Art.nr. 0969 700 316

VE/st. 1



Waterslang professional

PVC met polyester textielvoering in geel

1/2" - 50 meter

Art.nr. 0886 001 200

VE/st. 1

3/4" - 50 meter

Art.nr. 0886 001 210

VE/st. 1

Ook verkrijgbaar in 25/30 meter



Slangklemmen

Symmetrische schroef, staal, 12 mm breed, SW7

1/2" klembereik 12-22

Art.nr. 0539 112 22

VE/st. 50

3/4" klembereik 20-32

Art.nr. 0539 120 32

VE/st. 50



Schroevendraaier

Binnenzeskant, SW7, flexibel

Art.nr. 0613 286 07

VE/st. 1



WÜRTH BARCODE WATERSLANGKOPPELINGEN

<p>0886001001 VE 10 Slangklem MESSING KOPP. MET SLANGTULE 1/2"</p>	
<p>0886001011 VE 25 Slangkoppeling MESSING VERBINDINGSBUIS 1/2"</p>	
<p>0886001021 VE 10 Draadfitting met buitendraad MESSING AANSLUITSTUK BUITENDR 1/2"</p>	
<p>0886001031 VE 10 Draadfitting met binnendraad MESSING AANSLUITSTUK BINNENDR 1/2"</p>	
<p>0886001042 VE 1 Sputmondstuk MESSING STRAALPIJP 3/4</p>	
<p>0886001710 VE 1 Tapkraan, waterslang Met binnendraad KRAANSTUK-1.2G.-21MM-GARDENA</p>	
<p>0886001720 VE 1 Waterslangadapter met waterstop Insteek... WATERSTOP-1.2G-5.8G-13-15MM-GARDENA</p>	
<p>0886001730 VE 1 Gardena slangstuk SLANGSTUK-1.2G-5.8G-13-15MM-GARDENA</p>	
<p>0886001740 VE 1 Insteekkoppeling GARDENA voor het repare. REPARATEUR-1.2G-5.8G-13MM-15MM-GARDEN</p>	
<p>0886001770 VE 1 Drinkwaterreinigingspistool Gardena Clas... TUINSPUIT-GARDENA</p>	

<p>0886001002 VE 10 Slangklem MESSING KOPP. MET SLANGTULE 3/4</p>	
<p>0886001012 VE 25 Slangkoppeling MESSING VERBINDINGSBUIS 3/4"</p>	
<p>0886001022 VE 10 Draadfitting met buitendraad MESSING AANSLUITSTUK BUITENDR 3/4"</p>	
<p>0886001032 VE 10 Draadfitting met binnendraad MESSING AANSLUITSTUK BINNENDR 3/4"</p>	
<p>0886001050 VE 10 Blindkoppeling MESSING BLINDKOPPELING</p>	
<p>0886001711 VE 1 Tapkraan, waterslang Met binnendraad KRAANSTUK-3.4G.-26.5MM-GARDENA</p>	
<p>0886001721 VE 1 Gardena waterstop WATERSTOP-3.4G-19MM-GARDENA</p>	
<p>0886001731 VE 1 Gardena slangstuk SLANGSTUK-3.4G-19MM-GARDENA</p>	
<p>0886001741 VE 1 Insteekkoppeling GARDENA voor het repare. REPARATEUR-3.4G-19MM-GARDENA</p>	

WATERSLANGKOPPELINGEN

Aansluitstuk buitendraad

Messing

1/2" Art.nr. 0886 001 021 VE/st. 10

3/4" Art.nr. 0886 001 022 VE/st. 10

Ook verkrijgbaar in 1" en 1 1/4"



Aansluitstuk binnendraad

Messing

1/2" Art.nr. 0886 001 031 VE/st. 10

3/4" Art.nr. 0886 001 032 VE/st. 10

Ook verkrijgbaar in 1" en 1 1/4"



Slangklem snelkoppeling

Messing

1/2" Art.nr. 0886 001 001 VE/st. 10

3/4" Art.nr. 0886 001 002 VE/st. 10

Ook verkrijgbaar in 1" en 1 1/4"



Blindkoppelingafsluiter

Messing

1/2" & 3/4"

Art.nr. 0886 001 050 VE/st. 10



Spuitmond, straalpijp

Messing

3/4"

Art.nr. 0886 001 042

VE/st. 1



Slangkoppeling

Messing

1/2" Art.nr. 0886 001 011 VE/st. 25

3/4" Art.nr. 0886 001 012 VE/st. 25

Ook verkrijgbaar in 1" en 1 1/4"



GARDENA Classic spray

Art.nr. 0886 001 770

VE/st. 1



Kraanstuk, koppeling kraan

Kunststof



1/2" Art.nr. 0886 001 710 VE/st. 1

3/4" Art.nr. 0886 001 711 VE/st. 1

Slangstuk begin, koppeling kraanstuk

Kunststof



1/2" Art.nr. 0886 001 730 VE/st. 1

3/4" Art.nr. 0886 001 731 VE/st. 1

Slangstuk reparateur, koppeling 2 slangen

Kunststof



1/2" Art.nr. 0886 001 740 VE/st. 1

3/4" Art.nr. 0886 001 741 VE/st. 1

Slangstuk uiteinde waterstop

Kunststof



1/2" Art.nr. 0886 001 720 VE/st. 1

3/4" Art.nr. 0886 001 721 VE/st. 1

Aansluiting 1/2" = 21 mm / slang 13 mm Aansluiting 3/4" = 26,5 mm / slang 16 of 19 mm

WÜRTH BARCODE MARKEERVERF, VERF & KRIJT



071370 08 VE 1
Krijtpoeder
KRIJTSTOF, BLAUW



071370 082 VE 1
Krijtpoeder
KRIJTSTOF, ROOD



071370 240 VE 1
Slaglijngereedschap
SLAGLIJN-L30M



08921754 VE 1
Wegmarkeringsspray, fluorescerend
MARKERINGSVERF-ORANJE-500ML



08921755 VE 1
Wegmarkeringsspray, fluorescerend
MARKERINGSVERF-GEEL-500ML



08921756 VE 1
Wegmarkeringsspray, fluorescerend
MARKERINGSVERF-GROEN-500ML



08921757 VE 1
Wegmarkeringsspray, fluorescerend
MARKERINGSVERF-FLOU-ROZE-500ML



0893114113 VE 1
Zinkspray Perfect voor metalen oppervlak...
ZINKSPRAY PERFECT 400 ML



0893329005 VE 1
Lakspray nitroalkydkwaliteit, mat
LAKSPRAY MAT GITZWART 400 ML



0893339005 VE 1
Lakspray nitroalkydkwaliteit, hoogglans
LAKSPRAY HOOGL. GITZWART 600 ML



0967911201 VE 1 Marker
voor diepe gaten, set MARK-
SET-1STIFT- per 8 stuks



09844001 VE 12
Oliemarkeerkrijt
OLIEMARKEERKRIJT, WIT



09844002 VE 12
Oliemarkeerkrijt
OLIEMARKEERKRIJT, GEEL



09844003 VE 12
Oliemarkeerkrijt
OLIEMARKEERKRIJT, ROOD



09844004 VE 12
Oliemarkeerkrijt
OLIEMARKEERKRIJT, BLAUW



071564 03 VE 5
Beschermhoes
PLANBESCHERMINGSTAS



0993997047 VE 10
Beschermhoes
PROTPOKT-DINA1-640X900MM



MARKEERVERF, VERF & KRIJT



Markeerverf fluoriserend

- Oranje** Art.nr. 0892 175 4
 - Geel** Art.nr. 0892 175 5
 - Groen** Art.nr. 0892 175 6
 - Roze** Art.nr. 0892 175 7
- VE/st. 1

Ook verkrijgbaar in
standaard kleuren
wit, geel en rood



Verf- en zinkspray

- Zwart mat** Art.nr. 0893 329 005
 - Zwart hoogglans** Art.nr. 0893 339 005
 - Zinkspray** Art.nr. 0893 114 113
- VE/st. 1

Slaglijn poeder

- Blauw** Art.nr. 0713 70 08
 - Rood** Art.nr. 0713 70 082
- VE/st. 1



Slaglijnmolen

- Art.nr. 0713 70 240
- VE/st. 1



Olie markeerkrijt

- Wit** Art.nr. 0984 400 1
 - Geel** Art.nr. 0984 400 2
 - Rood** Art.nr. 0984 400 3
 - Blauw** Art.nr. 0984 400 4
- VE/st. 12



Tekeninghoes, bouwtekeninghoes

Met rits

- A0** Art.nr. 0715 64 03
VE/st. 5
- A1** Art.nr. 0993 997 047
VE/st. 10



Marker set 8 stuks

Voor diepe gaten

- Art.nr. 0967 911 201
- VE/set 1



WÜRTH BARCODE

POTLODEN, MEETGEREEDSCHAP & BATTERIJEN



071464 518 VE 1
Rolbandmaat in behuizing met rubbercoati...
ROLBANDMAAT 5M.X25MM. ROBUUST



071464713 VE 6
Metselaarspotlood
STEENHOEWERSPOTLOOD



071564 013 VE 12
Metselaarspotlood
STEENHOEWERSPOTLOOD-L30CM-OVAAL-10H



0827112 VE 4
Alkalinebatterij, hoog vermogen
BATT-ALKALINE AA-MIGNON-LR6-1,5V



0827114 VE 2
Alkalinebatterij, hoog vermogen
BATT-ALKALINE D-MONO-LR20-1,5V



0967915201 VE 1
Premium inktmarker
INKMRK-PREMIUM-PERMANENT-ZWART-(1,5-3)



0967915203 VE 5
Premium inktmarker
MARKER-PREMIUM-PERMANENT-BLAUW-(1,5-3MM)



0967915202 VE 5
Premium inktmarker
MARKER-PREMIUM-PERMANENT-ROOD-1,5-3MM



071464 538 VE 1
Rolbandmaat in behuizing met rubbercoati...
ROLBANDMAAT 8M.X25MM. ROBUUST



071564 01 VE 6
Timmermanspotlood
TIMMERMANSPOTLOOD



0827111 VE 4
Alkalinebatterij, hoog vermogen
BATT-ALKALINE AAA-MICRO-LR03-1,5V



0827113 VE 2
Alkalinebatterij, hoog vermogen
BATT-ALKALINE C-BABY-LR14-1,5V



0827115 VE 1
Alkalinebatterij, hoog vermogen
BATT-ALKALINE-E BLOCK-6LR61-9V



071464 512 VE 1
Rolbandmaat
ZAKMEETLINT, 5M



071464 530 VE 1
Rolbandmaat
ROLBANDMAAT 3M.X16MM. ROBUUST



071464 511 VE 1
Rolbandmaat
ZAKMEETLINT, 3M



POTLODEN, MEETGEREEDSCHAP & BATTERIJEN

Timmermanspotlood zacht

Art.nr. 0715 64 01
VE/st. 6



Metselaarspotlood hard

Weersbestendig

Art.nr. 0714 647 13
VE/st. 6



Art.nr. 0715 64 013
VE/st. 12



Stift, permanent marker, makeerstift

Zwart Art.nr. 0967 915 201
VE/st. 5



Rood Art.nr. 0967 915 202
VE/st. 5



Rolbandmaat

Robuust, 25 mm breed



5 meter
Art.nr. 0714 64 518
VE/st. 1

8 meter
Art.nr. 0714 64 538
VE/st. 1

Rolbandmaat

Robuust, 16 mm breed

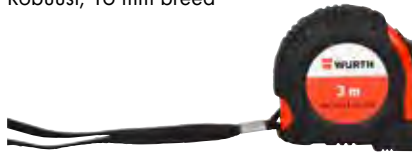

3 meter
Art.nr. 0714 64 530
VE/st. 1

Rolbandmaat

Standaard



3 meter 16 mm breed
Art.nr. 0714 64 511 VE/st. 1

5 meter 25 mm breed
Art.nr. 0714 64 512 VE/st. 1

Batterijen LR03

Potlood AAA

Art.nr. 0827 111
VE/blister 4 stuks / omdoos 60 stuks



Batterijen LR6

Penlite AA

Art.nr. 0827 112
VE/blister 4 stuks / omdoos 40 stuks



WÜRTH BARCODE MEETGEREEDSCHAP



0714644008 VE 1
Waterpas
WATERPAS, 2 HANDGREPEN, 800MM



0714644206 VE 1
Lichtmetalen waterpas
WATERPAS VAN LICHTMETAAL, 600MM



0714644960 VE 1
Waterpas, twee libellen
WATERPAS MET STELVOETJES 180 CM



071564 615 VE 1
Duimstok
TIMMERMANSDUIMSTOK 1M 4DLG PALMHOUT



0714641623 VE 1
Fiber-meetlint Met verhouding
FIBER-MEETLINT-30M



0714644204 VE 1
Lichtmetalen waterpas
WATERPAS VAN LICHTMETAAL, 400MM



0714644208 VE 1
Lichtmetalen waterpas
WATERPAS VAN LICHTMETAAL, 800MM



0714644961 VE 1
Waterpas, twee libellen
WATERPAS MET STELVOETJES 200 CM

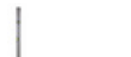

0715763250 VE 1
Platte winkelhaak
VLAKKE HOEK, DIN875/1, 250MM



MEETGEREEDSCHAP

Winkelhaak, vlakke hoek

DIN875

250 mm, met aanslag

Art.nr. 0715 763 250

VE/st. 1



Winkelhaak

Bahco

400 mm

Art.nr. 0997 644 375

VE/st. 1



Glasvezel meetlint

30 m

Art.nr. 0714 641 623

VE/st. 1



Zweihaak

Bahco

250 mm

Art.nr. 0997 644 376

VE/st. 1



Zweihaak

Stanley

267 mm, metaal met kunststof

Art.nr. 0997 644 374

VE/st. 1



Waterpas

40 cm Art.nr. 0714 644 204

60 cm Art.nr. 0714 644 206

80 cm Art.nr. 0714 644 208

VE/st. 1



Waterpas

80 cm

Art.nr. 0714 644 008

VE/st. 1



Waterpas

Met stelvoetjes, dubbele libellen



180 cm Art.nr. 0714 644 960

200 cm Art.nr. 0714 644 961

VE/st. 1

Duimstok



1 meter

Art.nr. 0715 64 615

VE/st. 1





WÜRTH BARCODE HAMERBOREN, BETON - SDS



 0648050007 VE 1
 Hamerboren cassette Plus Quadro-L Vario, ...
 BO-HAM-ASS-PLUS-Q-LV-7DLG
 



 0648051011 VE 2
 Hamerboor Plus Quadro-L Vario
 HAMERBOOR-SDSPLUS-Q-LV-D10,0-L115-WL50 **Ø 10x115**



 0648051021 VE 2
 Hamerboor Plus Quadro-L Vario
 HAMERBOOR-SDSPLUS-Q-LV-D10,0-L215-WL150 **Ø 10x215**



 0648051031 VE 2
 Hamerboor Plus Quadro-L Vario
 HAMERBOOR-SDSPLUS-Q-LV-D10,0-L315-WL250 **Ø 10x315**



 0648051221 VE 2
 Hamerboor Plus Quadro-L Vario
 HAMERBOOR-SDSPLUS-Q-LV-D12,0-L210-WL160 **Ø 12x210**



 0648055011 VE 2
 Hamerboor Plus Quadro-L Vario
 HAMERBOOR-SDSPLUS-Q-LV-D5,0-L115-WL50 **Ø 5x115**



 0648056011 VE 2
 Hamerboor Plus Quadro-L Vario
 HAMERBOOR-SDSPLUS-Q-LV-D6,0-L115-WL50 **Ø 6x115**



 0648058011 VE 2
 Hamerboor Plus Quadro-L Vario
 HAMERBOOR-SDSPLUS-Q-LV-D8,0-L115-WL50 **Ø 8x115**



 0648058021 VE 2
 Hamerboor Plus Quadro-L Vario
 HAMERBOOR-SDSPLUS-Q-LV-D8,0-L215-WL150 **Ø 8x215**



 0648050002 VE 1
 Hamerboren multipack Plus Quadro-L Vario
 HAMERBOOR MULTIPACK-4SNIJD-SDSPLUS-12E
 



 0648051016 VE 2
 Hamerboor Plus Quadro-L Vario
 HAMERBOOR-SDSPLUS-Q-LV-D10,0-L165-WL100 **Ø 10x165**



 0648051026 VE 2
 Hamerboor Plus Quadro-L Vario
 HAMERBOOR-SDSPLUS-Q-LV-D10,0-L265-WL200 **Ø 10x265**



 0648051216 VE 2
 Hamerboor Plus Quadro-L Vario
 HAMERBOOR-SDSPLUS-Q-LV-D12,0-L160-WL100 **Ø 12x160**

 0648051226 VE 2
 Hamerboor Plus Quadro-L Vario
 HAMERBOOR-SDSPLUS-Q-LV-D12,0-L260-WL210 **Ø 12x260**

 0648055016 VE 2
 Hamerboor Plus Quadro-L Vario
 HAMERBOOR-SDSPLUS-Q-LV-D5,0-L165-WL100 **Ø 5x165**

 0648056016 VE 2
 Hamerboor Plus Quadro-L Vario
 HAMERBOOR-SDSPLUS-Q-LV-D6,0-L165-WL100 **Ø 6x165**

 0648058016 VE 2
 Hamerboor Plus Quadro-L Vario
 HAMERBOOR-SDSPLUS-Q-LV-D8,0-L165-WL100 **Ø 8x165**

 0648058026 VE 2
 Hamerboor Plus Quadro-L Vario
 HAMERBOOR-SDSPLUS-Q-LV-D8,0-L265-WL200 **Ø 8x265**

HAMERBOREN, BETON - SDS PLUS

4 SNIJDERS

QUADRO - L VARIO

Diameter 5 t/m 32 mm

Lengtes tot 1000 mm

(afhankelijk van de diameter)

- Langere levensduur
- Zeer secuur
- Perfecte ronde gaten
- Stiller (minder snel)

Art.nr. 0648 05. ...

VE/st. 2

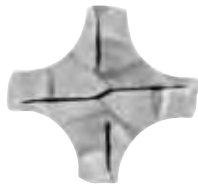

≤ Ø 10 mm



> Ø 10 mm



vanaf Ø 18 mm

Voorbeeld

Ø 5 x 160

Art.nr. 0648 055 016

Ø 10 x 115

Art.nr. 0648 051 011



Scan de QR-code
en bekijk de film



ASSORTIMENTEN

7-delige cassette

Inhoud:

Ø 5 x 115

Ø 6 x 115

Ø 8 x 115

Ø 6 x 165

Ø 8 x 165

Ø 10 x 165

Ø 12 x 160

Art.nr. 0648 050 007

VE 1 cassette



12-delige multipack

Inhoud:

3 x Ø 6 x 165

4 x Ø 8 x 165

3 x Ø 10 x 160

2 x Ø 12 x 160

Art.nr. 0648 050 002

VE 1 koker



WÜRTH BARCODE HAMERBOREN, BETON - SDS

<p>0648550007 VE 1 Hamerboorcassette Duo-S Vario met SDS-opname: BO-HAM-ASS-PLUS-DUO-SV-7DLG</p>	
<p>0648551011 VE 2 Hamerboor SDS-plus Duo-S Vario BO-HAM-SDSPLUS-DUO-SV-D10,0-L110-WL50</p> <p>Ø10x110</p>	
<p>0648551021 VE 2 Hamerboor SDS-plus Duo-S Vario BO-HAM-SDSPLUS-DUO-SV-D10,0-L210-WL150</p> <p>Ø10x210</p>	
<p>0648551031 VE 2 Hamerboor SDS-plus Duo-S Vario BO-HAM-SDSPLUS-DUO-SV-D10,0-L310-WL250</p> <p>Ø10x310</p>	
<p>0648551221 VE 2 Hamerboor SDS-plus Duo-S Vario BO-HAM-SDSPLUS-DUO-SV-D12,0-L210-WL160</p> <p>Ø12x210</p>	
<p>0648555011 VE 2 Hamerboor SDS-plus Duo-S Vario BO-HAM-SDSPLUS-DUO-SV-D5,0-L110-WL50</p> <p>Ø5x110</p>	
<p>0648556011 VE 2 Hamerboor SDS-plus Duo-S Vario BO-HAM-SDSPLUS-DUO-SV-D6,0-L110-WL50</p> <p>Ø6x110</p>	
<p>0648556021 VE 2 Hamerboor SDS-plus Duo-S Vario BO-HAM-SDSPLUS-DUO-SV-D6,0-L210-WL150</p> <p>Ø6x210</p>	
<p>0648558016 VE 2 Hamerboor SDS-plus Duo-S Vario BO-HAM-SDSPLUS-DUO-SV-D8,0-L160-WL100</p> <p>Ø8x160</p>	
<p>0648558026 VE 2 Hamerboor SDS-plus Duo-S Vario BO-HAM-SDSPLUS-DUO-SV-D8,0-L260-WL200</p> <p>Ø8x260</p>	

<p>0648550002 VE 1 Hamerboor Multipack SDS-plus Duo-S Vario... HAMERBOOR ASSORT.-SDSPLUS-DUO-SV-12DLC</p>	
<p>0648551016 VE 2 Hamerboor SDS-plus Duo-S Vario BO-HAM-SDSPLUS-DUO-SV-D10,0-L160-WL100</p> <p>Ø10x160</p>	
<p>0648551026 VE 2 Hamerboor SDS-plus Duo-S Vario BO-HAM-SDSPLUS-DUO-SV-D10,0-L260-WL200</p> <p>Ø10x260</p>	
<p>0648551216 VE 2 Hamerboor SDS-plus Duo-S Vario BO-HAM-SDSPLUS-DUO-SV-D12,0-L160-WL110</p> <p>Ø12x160</p>	
<p>0648551226 VE 2 Hamerboor SDS-plus Duo-S Vario BO-HAM-SDSPLUS-DUO-SV-D12,0-L260-WL210</p> <p>Ø12x260</p>	
<p>0648555016 VE 2 Hamerboor SDS-plus Duo-S Vario BO-HAM-SDSPLUS-DUO-SV-D5,0-L160-WL100</p> <p>Ø5x160</p>	
<p>0648556016 VE 2 Hamerboor SDS-plus Duo-S Vario BO-HAM-SDSPLUS-DUO-SV-D6,0-L160-WL100</p> <p>Ø6x160</p>	
<p>0648558011 VE 2 Hamerboor SDS-plus Duo-S Vario BO-HAM-SDSPLUS-DUO-SV-D8,0-L110-WL50</p> <p>Ø8x110</p>	
<p>0648558021 VE 2 Hamerboor SDS-plus Duo-S Vario BO-HAM-SDSPLUS-DUO-SV-D8,0-L210-WL150</p> <p>Ø8x210</p>	



HAMERBOREN, BETON - SDS PLUS

2 SNIJDERS

DUO-S VARIO / DUO SV
Diameter 4 t/m 26 mm
Lengtes tot 1000 mm
(afhankelijk van de diameter)

- Snel
- Prijs voordelig
- Minder krachtig dan 4 snijder

Art.nr. 0648 55. ...
 VE/st. 1



Voorbeeld

Ø 8 x 110 **Art.nr. 0648 558 011**
 Ø 12 x 160 **Art.nr. 0648 551 216**



ASSORTIMENTEN

7-delige cassette

- Inhoud:
- Ø 5 x 110
 - Ø 6 x 110
 - Ø 8 x 110
 - Ø 6 x 160
 - Ø 8 x 160
 - Ø 10 x 160
 - Ø 12 x 160

Art.nr. 0648 550 007
 VE 1 cassette



12-delige multipack

- Inhoud:
- 3 x Ø 6 x 160
 - 4 x Ø 8 x 160
 - 3 x Ø 10 x 160
 - 2 x Ø 12 x 160

Art.nr. 0648 550 002
 VE 1 koker



WÜRTH BARCODE

SDS-MAX, BEKISTINGSBOREN & HOUTBOREN



0631100400 VE 1
Speciale spiraalbekistingsboor, HSS, cil...
BEKBOOR-HSS-D10-L400MM



063180 400 VE 1
Speciale spiraalbekistingsboor, HSS, cil...
BEKISTINGSBOOR 8X400 MM HSS



0650810400 VE 5
Precisie-houtspiraalboor HSCo
HOUTSPIRAALBOOR-HSCO-D4,0MM



0650810600 VE 5
Precisie-houtspiraalboor HSCo
HOUTSPIRAALBOOR-HSCO-D6,0MM



0647051234 VE 1
Hamerboor Max Quadro-L Vario
HAMERBOOR-MAX-Q-LV-D12-L340-AL200MM



0647051434 VE 1
Hamerboor Max Quadro-L Vario
HAMERBOOR-MAX-Q-LV-D14-L340-AL200MM



0647051834 VE 1
Hamerboor Max Quadro-L Vario
HAMERBOOR-MAX-Q-LV-D18-L340-AL200MM



0647052432 VE 1
Hamerboor Max Quadro-L Vario
HAMERBOOR-MAX-Q-LV-D24-L320-AL200MM



0647052837 VE 1
Hamerboor Max Quadro-L Vario
HAMERBOOR-MAX-Q-LV-D28-L370-AL250MM



0647053537 VE 1
Hamerboor Max Quadro-L Vario
HAMERBOOR-MAX-Q-LV-D35-L370-AL250MM



0631120400 VE 1
Speciale spiraalbekistingsboor, HSS, cil...
BEKBOOR-HSS-D12-L400MM



0650810001 VE 1
Precisie-houtspiraalboor, HSCo, assortim...
HOUTSPIRAALBOOR-ASS.-HSCO-(D3-10)-10ST.



0650810500 VE 5
Precisie-houtspiraalboor HSCo
SPIRAALBOOR-WO-HSCO-P-D5,0MM



0650810800 VE 5
Precisie-houtspiraalboor HSCo
HOUTSPIRAALBOOR-HSCO-D8,0MM



0647051254 VE 1
Hamerboor Max Quadro-L Vario
HAMERBOOR-MAX-Q-LV-D12-L540-AL400MM



0647051454 VE 1
Hamerboor Max Quadro-L Vario
HAMERBOOR-MAX-Q-LV-D14-L540-AL400MM



0647051854 VE 1
Hamerboor Max Quadro-L Vario
HAMERBOOR-MAX-Q-LV-D18-L540-AL400MM



0647052452 VE 1
Hamerboor Max Quadro-L Vario
HAMERBOOR-MAX-Q-LV-D24-L520-AL400MM



0647052857 VE 1
Hamerboor Max Quadro-L Vario
HAMERBOOR-MAX-Q-LV-D28-L570-AL450MM



0647053557 VE 1
Hamerboor Max Quadro-L Vario
HAMERBOOR-MAX-Q-LV-D35-L570-AL450MM

HAMERBOREN

SDS-MAX, BEKISTINGSBOREN & HOUTBOREN

4 SNIJDERS SDS-MAX

QUADRO-L VARIO

- Langere levensduur
- Zeer secuur
- Meer kracht
- Minder vibratie

Art.nr. 0647 05. ... (maat x lengte -0)
VE/st. 1

Voorbeeld

Ø 22 x 320 Art.nr. 0647 052 232
Ø 26 x 520 Art.nr. 0647 052 652



≤ Ø 15 mm



vanaf Ø 16 mm

SDS-MAX



SDS-PLUS

HSS Bekistingsboor

Cilindrische schacht

8 x 400 mm Art.nr. 0631 80 400
10 x 400 mm Art.nr. 0631 100 400
12 x 400 mm Art.nr. 0631 120 400

VE/st. 1

Ook in 600 en 800 mm lengte en in 14, 16 en 18 mm verkrijgbaar



HSCo Houtspiraalboor

Hardhout, zacht hout, tropisch hardhout, kunststoffen en geplastificeerd spaanplaat

Maten:

3 t/m 20 mm

4 mm Art.nr. 0650 810 400
5 mm Art.nr. 0650 810 500
6 mm Art.nr. 0650 810 600
8 mm Art.nr. 0650 810 800

VE/st. 5



HSCo Houtspiraalboor

Assortiment:

3, 4, 5 (2x), 6 (2x), 7, 8 en 10 mm

Art.nr. 0650 810 001

VE/st. 1



WÜRTH BARCODE MACHINEBEITELS SDS-PLUS & SDS-MAX

4 0 6 1 9 7 5 2 2 7 8 3 6
0647861280 VE 1
Max Longlife & Speed puntbeitel
PUNTBEITEL-MAX-LS-L280MM



4 0 6 1 9 7 5 2 2 7 8 4 3
0647862225 VE 1
Max Longlife & Speed platte beitel
PLATTEBEITEL-MAX-LS-L280-B25MM



4 0 6 5 7 4 8 5 9 0 3 9 6
064786350 VE 1
Max Longlife & Speed spadebeitel
SPADEBEITEL-MAX-LS-L380-B50MM



4 0 5 6 8 0 7 4 5 6 6 1 4
0648861250 VE 1
Puntbeitel Plus Longlife & Speed
PUNTBEITEL-PLUS-LS-L250MM



4 0 6 5 7 4 8 5 9 0 3 4 1
0648863250 VE 1
Spadebeitel Plus Longlife & Speed
SPADEBEITEL-PLUS-LS-L250-B40MM



4 0 6 5 7 4 8 5 9 0 9 4 5
0647860003 VE 1
Max Longlife & Speed punt-, platte en spadebeitels,
BEITEL-MACHINE-SET-MAX-LS-MULTIPACK



4 0 5 6 8 0 7 4 5 6 6 6 9
0647861400 VE 1
Max Longlife & Speed puntbeitel
PUNTBEITEL-MAX-LS-L400MM



4 0 5 6 8 0 7 4 5 6 5 9 1
0647862425 VE 1
Max Longlife & Speed platte beitel
PLATTEBEITEL-MAX-LS-L400-B25MM



4 0 6 5 7 4 8 5 9 0 9 5 2
0648860003 VE 1
Punt-, platte en spadebeitels, multi-pack ...
MACHINEBEITEL-SET-PLUS-LS-MULTIPACK



4 0 5 6 8 0 7 4 5 6 6 3 8
0648862250 VE 1
Platte beitel Plus Longlife & Speed
PLATTEBEITEL-PLUS-LS-L250-B20MM



MACHINEBEITELS SDS-PLUS & SDS-MAX

SDS-PLUS

Spitsbeitel, puntbeitel Longlife & speed

250 mm
Art.nr. 0648 861 250
 VE/st. 1



Vlakbeitel, platte beitel Longlife & speed

20 mm breed, 250 mm
Art.nr. 0648 862 250
 VE/st. 1



Spadebeitel

40 mm breed, premium

250 mm
Art.nr. 0648 863 250
 VE/st. 1



Set beitels SDS-PLUS

1x puntbeitel 250 mm
 1x koudbeitel 250 mm
 1x vlakbeitel 250 mm

Art.nr. 0648 860 003
 VE/st. 1



SDS-MAX

Puntbeitel

Art.nr. 0647 861 280
Art.nr. 0647 861 400
 VE/st. 1



Koudbeitel

Art.nr. 0647 862 225
Art.nr. 0647 862 425
 VE/st. 1



Spadebeitel

50 mm breed, premium

380 mm **Art.nr. 0647 863 50**
 VE/st. 1



Set beitels SDS-MAX

1x puntbeitel 400 mm
 1x koudbeitel 400 mm
 1x spadebeitel 380 mm

Art.nr. 0647 860 003
 VE/st. 1



WÜRTH BARCODE DIAMANTZAAGBLADEN

 5527160115 VE 1 Diamantslijpschijf Bouwplaats, gesegment... DIAMANTSLIJPSCH.-BOUW-ASGAT22,2-D115MM		 5527160125 VE 1 Diamantslijpschijf Bouwplaats, gesegment... DIAMANTSLIJPSCH.-BOUW-ASGAT22,2-D125MM	
 5527160180 VE 1 Diamantslijpschijf Bouwplaats, gesegment... DIAMANTSLIJPSCH.-BOUW-ASGAT22,2-D180MM		 5527160230 VE 1 Diamantslijpschijf Bouwplaats, gesegment... DIAMANTSLIJPSCH.-BOUW-ASGAT22,2-D230MM	
 5527165115 VE 1 Diamantslijpschijf Bouwplaats, gesloten DIAMANTSLIJPSCH.-BOUW-ASGAT22,2-D115MM		 5527165125 VE 1 Diamantslijpschijf Bouwplaats, gesloten DIAMANTSLIJPSCH.-BOUW-ASGAT22,2-D125MM	
 5527165180 VE 1 Diamantslijpschijf Bouwplaats, gesloten DIAMANTSLIJPSCH.-BOUW-ASGAT22,2-D180MM		 5527165230 VE 1 Diamantslijpschijf Bouwplaats, gesloten DIAMANTSLIJPSCH.-BOUW-ASGAT22,2-D230MM	
 0667410122 VE 1 Doorslijpschijf met hardmetalen coating DOORSLIJPSCHIJF-HM-2,0-BO22,2-D125MM		 0667410232 VE 1 Doorslijpschijf met hardmetalen coating DOORSLIJPSCHIJF-HM-2,1-BO22,2-D230MM	
 5526664115 VE 1 Longlife & Speed RS Plus diamantslijpschijf, ... SCH-DIA-LS-RSP-BOUWPLAATS-BO22,23-D115MM		 5526664125 VE 1 Longlife & Speed RS Plus diamantslijpschijf, ... SCH-DIA-LS-RSP-BOUWPLAATS-BO22,23-D125	
 5526664180 VE 1 Longlife & Speed RS Plus diamantslijpschijf, ... SCH-DIA-LS-RSP-BOUWPLAATS-BO22,23-D180MM		 5526664230 VE 1 Longlife & Speed RS Plus diamantslijpschijf, ... SCH-DIA-LS-RSP-BOUWPLAATS-BO22,23-D230	

DIAMANTZAAGBLADEN, DOORSLIJPSCHIJF

Diamantzaagblad universeel

- Premium diamantzaagblad
- Lange levensduur, hoge snelheid
- Nauwkeurig, voor nat- en droogzagen
- Gewapend beton, dakpannen, beton, klinkers, kalkzandsteen, marmer en graniet

115 mm Art.nr. 5526 664 115

125 mm Art.nr. 5526 664 125

180 mm Art.nr. 5526 664 180

230 mm Art.nr. 5526 664 230

VE/st. 1



Diamantkomschijven

Art.nr. 0666 ...

VE/st. 1



Diamantslijpschijf, gesegmenteerd

Uiterst veelzijdige, duurzame en voordelige slijpschijf voor bouwplaatsen, die tevens geschikt is voor gebruik op muursleuvenfreesen.

Art.nr. 5527 160 ...

VE/st. 1



Diamantslijpschijf, gesloten

Art.nr. 5527 165 ...

VE/st. 1



Doorslijpschijf met hardmetalen coating

De slijpschijf is voorzien van speciaal ontwikkelde hardmetalen granulaat en wordt gebruikt op de haakse slijper voor het snel slijpen.

125 mm

Art.nr. 0667 410 122

VE/st. 1

230 mm

Art.nr. 0667 410 232

VE/st. 1



Scan de QR-code en bekijk de film



WÜRTH BARCODE METAALBOREN

 062510 VE 10 DIN 338 spiraalboor HSS type RN SPIR. BOOR HSS DIN338 1,0 MM	 1 mm	 0625100 VE 5 DIN 338 spiraalboor HSS type RN SPIR. BOOR HSS DIN338 10,0 MM	 10 mm
 0625110 VE 1 DIN 338 spiraalboor HSS type RN SPIR. BOOR HSS DIN338 11,0 MM	 11 mm	 0625120 VE 1 DIN 338 spiraalboor HSS type RN SPIR. BOOR HSS DIN338 12,0 MM	 12 mm
 0625130 VE 1 DIN 338 spiraalboor HSS type RN SPIR. BOOR HSS DIN338 13,0 MM	 13 mm	 062515 VE 10 DIN 338 spiraalboor HSS type RN SPIR. BOOR HSS DIN338 1,5 MM	 1,5 mm
 062520 VE 10 DIN 338 spiraalboor HSS type RN SPIR. BOOR HSS DIN338 2,0 MM	 2 mm	 062525 VE 10 DIN 338 spiraalboor HSS type RN SPIR. BOOR HSS DIN338 2,5 MM	 2,5 mm
 062530 VE 10 DIN 338 spiraalboor HSS type RN SPIR. BOOR HSS DIN338 3,0 MM	 3 mm	 062535 VE 10 DIN 338 spiraalboor HSS type RN SPIR. BOOR HSS DIN338 3,5 MM	 3,5 mm
 062540 VE 10 DIN 338 spiraalboor HSS type RN SPIR. BOOR HSS DIN338 4,0 MM	 4 mm	 062545 VE 10 DIN 338 spiraalboor HSS type RN SPIR. BOOR HSS DIN338 4,5 MM	 4,5 mm
 062550 VE 10 DIN 338 spiraalboor HSS type RN SPIR. BOOR HSS DIN338 5,0 MM	 5 mm	 062555 VE 10 DIN 338 spiraalboor HSS type RN SPIR. BOOR HSS DIN338 5,5 MM	 5,5 mm
 062560 VE 10 DIN 338 spiraalboor HSS type RN SPIR. BOOR HSS DIN338 6,0 MM	 6 mm	 062565 VE 10 DIN 338 spiraalboor HSS type RN SPIR. BOOR HSS DIN338 6,5 MM	 6,5 mm
 062570 VE 10 DIN 338 spiraalboor HSS type RN SPIR. BOOR HSS DIN338 7,0 MM	 7 mm	 062575 VE 10 DIN 338 spiraalboor HSS type RN SPIR. BOOR HSS DIN338 7,5 MM	 7,5 mm
 062580 VE 10 DIN 338 spiraalboor HSS type RN SPIR. BOOR HSS DIN338 8,0 MM	 8 mm	 062585 VE 5 DIN 338 spiraalboor HSS type RN SPIR. BOOR HSS DIN338 8,5 MM	 8,5 mm
 062590 VE 5 DIN 338 spiraalboor HSS type RN SPIR. BOOR HSS DIN338 9,0 MM	 9 mm	 062595 VE 5 DIN 338 spiraalboor HSS type RN SPIR. BOOR HSS DIN338 9,5 MM	 9,5 mm

METAALBOREN

HSS met punthoek 118°, standaard gewalste metaalboor DIN338

Art.nr. 0625 .. (maat)

Voorbeeld

- 5,8 mm **Art.nr. 0625 58**
- 11,0 mm **Art.nr. 0625 110**



ASSORTIMENTEN

19-delige koker

1 - 10 mm stappen 0,5 mm

Art.nr. 0625 01
VE/st. 1



19-delige cassette

1 - 10 mm stappen 0,5 mm

Art.nr.
0625 000 019
VE/st. 1



25-delige cassette

1 - 13 mm stappen 0,5 mm

Art.nr. 0625 000 025
VE/st. 1



Assortiment Spiraalboren HSS DIN 338 Type RN

118° 155 delig

1 - 10,5 mm stappen 0,5 mm

Inhoud:

- 10 stuks per type: 1 tot 6 mm
- 5 stuks per type: 6,5 tot 10,5 mm

Art.nr. 5964 062 500
VE/st. 1



Inlay 20-vaks voor 4.4.1 ORSY systeemkoffer

Art.nr. 5581 003 021
VE/st. 1



WÜRTH BARCODE METAALBOREN

<p>0624000019 VE 1 Assortiment spiraalboren HSS DIN 338 Type ... BO-MET-ASS-DIN338-HSS-(D1-10)-0,5-19DLG</p>	<p>0624000025 VE 1 Assortiment spiraalboren HSS DIN 338 type ... BO-MET-ASS-DIN338-HSS-(D1-13)-0,5-25DLG</p>
<p>0624000400 VE 10 DIN 338 spiraalboor HSS type RN ZEBRA SPIR. BOOR HSS DIN338 4,0MM</p> <p>4 052712 043666 ></p> <p>4 mm</p>	<p>0624000500 VE 10 DIN 338 spiraalboor HSS type RN ZEBRA SPIR. BOOR HSS DIN338 5,0MM</p> <p>4 052712 043734 ></p> <p>5 mm</p>
<p>0624000600 VE 10 DIN 338 spiraalboor HSS type RN ZEBRA SPIR. BOOR HSS DIN338 6,0MM</p> <p>4 052712 043802 ></p> <p>6 mm</p>	<p>0624000800 VE 10 DIN 338 spiraalboor HSS type RN ZEBRA SPIR. BOOR HSS DIN338 8,0MM</p> <p>4 052712 043925 ></p> <p>8 mm</p>
<p>062501 VE 1 Spiraalboor box HSS type RN BOX SPIRAALBOREN 19 DLG 1-10MM</p>	<p>5964062400 VE 1 Assortiment spiraalboren HSS DIN 338, 82 delig</p>
<p>0626000400 VE 10 Spiraalboor HSCO DIN 338 type RN oxide BO-SPRL-MET-DIN338-HSCO-OX-D4,0</p>	<p>0626000500 VE 10 Spiraalboor HSCO DIN 338 type RN oxide BO-SPRL-MET-DIN338-HSCO-OX-D5,0</p>
<p>0626000600 VE 5 Spiraalboor HSCO DIN 338 type RN oxide BO-SPRL-MET-DIN338-HSCO-OX-D6,0</p>	<p>0626000800 VE 5 Spiraalboor HSCO DIN 338 type RN oxide BO-SPRL-MET-DIN338-HSCO-OX-D8,0</p>
<p>0625000019 VE 1 Assortiment spiraalboren HSS DIN 338 type ... BO-MET-ASS-DIN338-HSS-(D1-10)-0,5-19DLG</p>	<p>0625000025 VE 1 Assortiment spiraalboren HSS DIN 338 Type ... BO-MET-ASS-DIN338-HSS-(D1-13)-0,5-25DLG</p>
<p>0626000019 VE 1 Assortiment spiraalboren HSCO DIN 338 type ... BO-MET-ASS-DIN338-HSCO-OX-(D1-10)-0,5</p>	<p>0626000025 VE 1 Assortiment spiraalboren HSCO DIN 338 type ... BO-MET-ASS-DIN338-HSCO-OX-(D1-13)-0,5</p>

METAALBOREN

Premium HSS metaalboor **DIN338**

- Lange levensduur
- Geslepen boor
- Nauwkeurig
- Zelf centrend



Art.nr. **0624 00.** ... (maat)

Voorbeeld

5,8 mm **Art.nr. 0624 000 580**
 10,0 mm **Art.nr. 0624 001 000**

ASSORTIMENTEN

19-delig cassette

1 - 10 mm stappen 0,5 mm

Art.nr. **0624 000 019**
 VE/st. 1



25-delig cassette

1 - 13 mm stappen 0,5 mm

Art.nr. **0624 000 025**
 VE/st. 1



82-delig

Art.nr. **5964 062 400**
 VE/st. 1



Premium HSCo metaalboor, **DIN 338**

- Voor RVS en staal
- Nauwkeurig
- Zelf centrend



Art.nr. **0626 00.** ... (maat)

Voorbeeld

3,2 mm **Art.nr. 0626 000 320**
 9,0 mm **Art.nr. 0626 000 900**

ASSORTIMENT

19-delig cassette

1 - 10 mm stappen 0,5 mm

Art.nr. **0626 000 019**
 VE/st. 1



25-delig cassette

1 - 13 mm stappen 0,5 mm

Art.nr. **0626 000 025**
 VE/st. 1



WÜRTH BARCODE

SLIJPSCHIJVEN & AFBRAAMSCHIJVEN



0579400324 VE 10
Lamellenschuurschijf voor staal
LAMELSCHUURSCHIJF-GLASV.125 K40
BLAUW



0579400328 VE 10
Lamellenschuurschijf voor staal
LAMELSCHUURSCHIJF-GLASV.125 K80
BLAUW



0664101250 VE 25
Doorslijpschijf voor staal Speed
ZEBRA DOORSLIJP.SPEED BLAUW
125X1,0

0664101802 VE 25
Doorslijpschijf voor staal Speed
DOORSLIJP.SPEED STAAL BLAUW
180X2,0



0669101152 VE 25
Doorslijpschijf
WÜRTH DOORSLIJP.SCH. BLAUW
115X2,5



0669101803 VE 25
Doorslijpschijf WÜRTH BLAUW STAAL
180X3,0



0669131150 VE 100
Doorslijpschijf
WÜRTH DOORSLIJP.SCH. GROEN
115X1,0



0669381156 VE 25
Afbraamschijf voor staal en roestvast st...
AFBR.SCH-ST/A2-GEZET-6,0-D115MM



0669381806 VE 10
Afbraamschijf voor staal en roestvast st...
AFBR.SCH-ST/A2-GEZET-6,0-D180MM



0670101252 VE 25
Doorslijpschijf voor staal Longlife ZEBRA
DOORSLIJP.LONGL.BLAUW 125X2,5





0670161157 VE 25
Afbraamschijf Longlife voor staal ZEBRA
AFBR.SCH. LONGL.BLAUW 115X7,0





0579400326 VE 10
Lamellenschuurschijf voor staal
LAMELSCHUURSCHIJF-GLASV.125 K60
BLAUW





0664101150 VE 25
Doorslijpschijf voor staal Speed
ZEBRA DOORSLIJP.SPEED BLAUW
115X1,0



0664101251 VE 25
Doorslijpschijf voor staal Speed
ZEBRA DOORSLIJP.SPEED BLAUW
125X1,6

0664102302 VE 25
Doorslijpschijf voor staal Speed
ZEBRA DOORSLIJP.SPEED BLAUW
230X2,0

0669101252 VE 25
Doorslijpschijf WÜRTH BLAUW
125X2,5

0669102303 VE 25
Doorslijpschijf WÜRTH BLAUW
230X3,0



0669131250 VE 100
Doorslijpschijf
WÜRTH DOORSLIJP.SCH. GROEN
125X1,0





0669381256 VE 25
Afbraamschijf voor staal en roestvast st...
AFBR.SCH-ST/A2-GEZET-6,0-D125MM



0669382306 VE 10
Afbraamschijf voor staal en roestvast st...
AFBR.SCH-ST/A2-GEZET-6,0-D230MM



0670102302 VE 25
Doorslijpschijf voor staal Longlife ZEBRA
DOORSLIJP.LONGL.BLAUW 230X2,5

0670161257 VE 25
Afbraamschijf Longlife voor staal ZEBRA
AFBR.SCH. LONGL.BLAUW 125X7,0



SLIJPSCHIJVEN & AFBRAAMSCHIJVEN

Doorslijpschijf SPEED

Staal

- Kwaliteit doorslijpschijf
- Hoge snelheid
- Lange levensduur

- 115 x 1,0** Art.nr. 0664 101 150
125 x 1,0 Art.nr. 0664 101 250
125 x 1,6 Art.nr. 0664 101 251
180 x 2,0 Art.nr. 0664 101 802
230 x 2,0 Art.nr. 0664 102 302

VE/st. 25



Doorslijpschijf

RVS

- Standaard doorslijpschijf

- 115 x 1,0** Art.nr. 0669 131 150
125 x 1,0 Art.nr. 0669 131 250

VE/st. 100



Doorslijpschijf

Staal

- Standaard doorslijpschijf
- Dikker

- 115 x 2,5** Art.nr. 0669 101 152
125 x 2,5 Art.nr. 0669 101 252
115 x 3,0 Art.nr. 0669 101 803
125 x 3,0 Art.nr. 0669 102 303

VE/st. 25



Afbraamschijf

Staal



- Standaard afbraamschijf

- 115 x 6,0** Art.nr. 0669 381 156
125 x 6,0 Art.nr. 0669 381 256
180 x 8,0 Art.nr. 0669 381 806
230 x 6,0 Art.nr. 0669 382 306

VE/st. 25



Afbraamschijf

LONGLIFE

Staal



- Lange levensduur

- 115 x 7,0** Art.nr. 0670 161 157
125 x 7,0 Art.nr. 0670 161 257

VE/st. 25



Doorslijpschijf

LONGLIFE

- Lange levensduur

- 125 x 2,5** Art.nr. 0670 101 252
230 x 2,5 Art.nr. 0670 102 302

VE/st. 25



Lamellenschuurschijf

115 mm

- K40 Art.nr. 0579 400 314
 K60 Art.nr. 0579 400 316
 K80 Art.nr. 0579 400 318

VE/st. 10

(115 mm geen barcodes)

125 mm

- K40 Art.nr. 0579 400 324
 K60 Art.nr. 0579 400 326
 K80 Art.nr. 0579 400 328

VE/st. 10



WÜRTH BARCODE SPEEDBOREN OF VLINDERBOREN

 0650005010 VE 1 Speedboor met twee snijkanten SPEEDBOOR-D10X160MM	 10 mm
 0650005016 VE 1 Speedboor met twee snijkanten SPEEDBOOR-D16X160MM	 16 mm
 0650005020 VE 1 Speedboor met twee snijkanten SPEEDBOOR-D20X160MM	 20 mm
 0650005030 VE 1 Speedboor met twee snijkanten SPEEDBOOR-D30X160MM	 30 mm
 0650005036 VE 1 Speedboor met twee snijkanten SPEEDBOOR-D36X160MM	 36 mm
 0650007003 VE 1 Verlengstuk boor, andere SPEEDBOORVERLENGSTUK 300 MM	
 0650007010 VE 1 Vlakboor SPEEDBOOR-L150MM-Ø10MM	 10 mm
 0650007016 VE 1 Vlakboor SPEEDBOOR-L150MM-Ø16MM	 16 mm
 0650007020 VE 1 Vlakboor SPEEDBOOR-L150MM-Ø20MM	 20 mm
 0650007030 VE 1 Vlakboor SPEEDBOOR-L150MM-Ø30MM	 30 mm
 0650007040 VE 1 Vlakboor SPEEDBOOR-L150MM-Ø40MM	 40 mm

 0650005012 VE 1 Speedboor met twee snijkanten SPEEDBOOR-D12X160MM	 12 mm
 0650005018 VE 1 Speedboor met twee snijkanten SPEEDBOOR-D18X160MM	 18 mm
 0650005025 VE 1 Speedboor met twee snijkanten SPEEDBOOR-D25X160MM	 25 mm
 0650005032 VE 1 Speedboor met twee snijkanten SPEEDBOOR-D32X160MM	 32 mm
 0650005040 VE 1 Speedboor met twee snijkanten SPEEDBOOR-D40X160MM	 40 mm
 0650007004 VE 1 Vlakborensset 6-delig SPEEDBOOR 6DELIG ASS.-L150-Ø10-25MM	
 0650007012 VE 1 Vlakboor SPEEDBOOR-L150MM-Ø12MM	 12 mm
 0650007018 VE 1 Vlakboor SPEEDBOOR-L150MM-Ø18MM	 18 mm
 0650007025 VE 1 Vlakboor SPEEDBOOR-L150MM-Ø25MM	 25 mm
 0650007035 VE 1 Vlakboor SPEEDBOOR-L150MM-Ø35MM	 35 mm

SPEEDBOREN OF VLINDERBOREN (VLAKBOREN)

Wij hebben in ons pakket twee uitvoeringen

Standaard speedboor met punt

Twee snijkanten

152 mm lang

Maten: 6 - 8 - 10 - 12 - 14 - 16 - 18 - 19 - 20 - 22 - 24 - 25 - 26 - 28 - 30 - 32 - 35 - 38 - 40

Art.nr. 0650 005 0.. (maat)

VE/st. 1



Speedboor met schroefpunt

Boort 5x sneller dan een standaard speedboor

Maten: 6 - 8 - 10 - 12 - 14 - 16 - 18 - 20 - 22 - 25 - 26 - 30 - 32 - 35 - 40

Art.nr. 0650 007 0.. (maat)

VE/st. 1



Speedboor met spaanbrekers

400 mm lang

Maten: 8 - 10 - 12 - 14 - 16 - 18 - 20 - 22 - 25 - 28 - 32

Art.nr. 0650 006 0.. (maat)

VE/st. 1



Speedboor met schroefpunt

400 mm lang

Maten: 8 - 10 - 12 - 14 - 16 - 18 - 20 - 22 - 26 - 30 - 35

Art.nr. 0650 008 0.. (maat)

VE/st. 1



AANVULLINGEN

Speedboor verlengstuk

Art.nr. 0650 007 003

VE/st. 1



Speedboor assortiment met boorpunt

Art.nr. 0650 007 004

VE/st. 1



Speedboor assortiment

152 mm lang

Maten: 8 - 10 - 12 - 14 - 16 - 18 - 20 - 22 - 25 - 28 - 32

Art.nr. 0650 005 001

VE/st. 1



WÜRTH BARCODE GATZAGEN

0632014 VE 1
Centreerboor A014C
CENTREERBOOR KORT A014C

063202 VE 1
Adapter A2
GATZAAGHOUDER A2

063205 VE 1
Verlengstuk voor gatzaag
VERLENGSTUK VOOR 0632 02

0632900019 VE 1
Gatzaag HSS bimetaal Longlife en Speed
GATZAAG-ZEBRA-HSS-BI METAAL-
D19MM

0632900025 VE 1
Gatzaag HSS bimetaal Longlife en Speed
GATZAAG-ZEBRA-HSS-BI METAAL-
D25MM

0632900035 VE 1
Gatzaag HSS bimetaal Longlife en Speed
GATZAAG-ZEBRA-HSS-BI METAAL-
D35MM

0632900044 VE 1
Gatzaag HSS bimetaal Longlife en Speed
GATZAAG-ZEBRA-HSS-BI METAAL-
D44MM

0632900057 VE 1
Gatzaag HSS bimetaal Longlife en Speed
GATZAAG-ZEBRA-HSS-BI METAAL-
D57MM

0632900067 VE 1
Gatzaag HSS bimetaal Longlife en Speed
GATZAAG-ZEBRA-HSS-BI METAAL-
D67MM

0632900086 VE 1
Gatzaag HSS bimetaal Longlife en Speed
GATZAAG-ZEBRA-HSS-BI METAAL-
D86MM

5964063291 VE 1
ZEBRA gatzagenset HSSCO8, systeemkoffer ...
ASS-CYLZAAG-HSSCO8-(19-76MM)-16DLG-SYSK

06320141 VE 1
Centreerboor A014D
CENTREERBOOR LANG A014D

063204 1 VE 1
Adapter A4
GATZAAGHOUDER A4

063207 VE 1
Uitdrukveer A7
UITDRUKVEER A7 TBV GATZAAG

0632900022 VE 1
Gatzaag HSS bimetaal Longlife en Speed
GATZAAG-ZEBRA-HSS-BI METAAL-
D22MM

0632900032 VE 1
Gatzaag HSS bimetaal Longlife en Speed
GATZAAG-ZEBRA-HSS-BI METAAL-
D32MM

0632900038 VE 1
Gatzaag HSS bimetaal Longlife en Speed
GATZAAG-ZEBRA-HSS-BI METAAL-
D38MM

0632900051 VE 1
Gatzaag HSS bimetaal Longlife en Speed
GATZAAG-ZEBRA-HSS-BI METAAL-
D51MM

0632900064 VE 1
Gatzaag HSS bimetaal Longlife en Speed
GATZAAG-ZEBRA-HSS-BI METAAL-
D64MM

0632900076 VE 1
Gatzaag HSS bimetaal Longlife en Speed
GATZAAG-ZEBRA-HSS-BI METAAL-
D76MM

0632900127 VE 1
Gatzaag HSS bimetaal Longlife en Speed
GATZAAG-ZEBRA-HSS-BI METAAL-
D127MM

GATZAGEN

Wij hebben in ons pakket HSCO 8% BI metaal LONGLIFE gatzagen

HSCO is HSS met 8% kobalt voor betere prestaties en langere levensduur

Gatzaag HSS bimetaal Longlife en Speed

- Ø 14 mm tot Ø 200 mm
- Zaagdiepte 38 mm
- Veel verkochte maten: 19, 22, 35, 44, 51, 67, 76, 86, 127 mm

Art.nr. 0632 900 ... (maat)

VE/st. 1



AANVULLINGEN

Gatzaaghouder A4

Is voor Ø 14 - Ø 30 mm

Met centreerboor

Art.nr. 0632 041

VE/st. 1

Losse centreerboor

Art.nr. 0632 014

VE/st. 1



Gatzaaghouder A2

Is voor Ø 32 - Ø 200 mm

Met centreerboor

Art.nr. 0632 02

Losse centreerboor

Art.nr. 0632 014 1

VE/st. 1



Verlengstuk

Alleen A2

Art.nr. 0632 05

VE/st. 1



Uitdrukveer A7

Art.nr. 0632 07

VE/st. 1

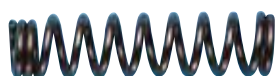

Zebra gatzagenset HSSC08

Inhoud assortimentsbox:

19, 22, 25, 32, 35, 38, 44, 51, 57, 64, 68 en 76 mm

Art.nr. 5964 063 291

VE/st. 1



WÜRTH BARCODE GATZAGEN



0632500019 VE 1
Hard metalen gatzaag Profit
GATZAAG-PROFIT-HM-ADAPT-D19MM



0632500022 VE 1
Hard metalen gatzaag Profit
GATZAAG-PROFIT-HM-ADAPT-D22MM



0632500029 VE 1
Hard metalen gatzaag Profit
GATZAAG-PROFIT-HM-ADAPT-D29MM



0632500044 VE 1
Hard metalen gatzaag Profit
GATZAAG-PROFIT-HM-ADAPT-D44MM



0632500064 VE 1
Hard metalen gatzaag Profit
GATZAAG-PROFIT-HM-ADAPT-D64MM



0632500076 VE 1
Hard metalen gatzaag Profit
GATZAAG-PROFIT-HM-ADAPT-D76MM



0632500086 VE 1
Hard metalen gatzaag Profit
PROFIT-GATZAAG-MP-D86MM



0666620082 VE 1
Diamant-doosverzinkboor H70-S
DOZENBOOR-DIAMANT-H70S-TURBO-D82MM



0632510001 VE 1
Centreerboor Gatzaag Profit
CENTR.BOOR 6K-HOUT-HSS-L164MM D14-30



0632510011 VE 1
Centreerboor Gatzaag Profit
CENTR.BOOR 6K-HOUT-HSS-L184MM D32-330



0632500020 VE 1
Hard metalen gatzaag Profit
GATZAAG-PROFIT-HM-ADAPT-D20MM



0632500025 VE 1
Hard metalen gatzaag Profit
GATZAAG-PROFIT-HM-ADAPT-D25MM



0632500035 VE 1
Hard metalen gatzaag Profit
GATZAAG-PROFIT-HM-ADAPT-D35MM



0632500051 VE 1
Hard metalen gatzaag Profit
GATZAAG-PROFIT-HM-ADAPT-D51MM



0632500067 VE 1
Hard metalen gatzaag Profit
GATZAAG-PROFIT-HM-ADAPT-D67MM



0632500082 VE 1
Hard metalen gatzaag Profit
GATZAAG-PROFIT-HM-ADAPT-D82MM



0632500127 VE 1
Hard metalen gatzaag Profit
PROFIT-GATZAAG-MP-D127MM



0666635082 VE 1
Diamant-doosverzinkboor U90
DOZENBOOR-DIA-U90-D82MM-AL70MM



0632510002 VE 1
Centreerboor Gatzaag Profit
CENTR.BOOR 6K-STEEN-HM-L166MM D16-30



0632510012 VE 1
Centreerboor Gatzaag Profit
CENTR.BOOR 6K-STEEN-HM-L186MM D32-330



GATZAGEN



Eenvoudig de prop verwijderen



Gat vergroten



Snel wisselen van gatzaag

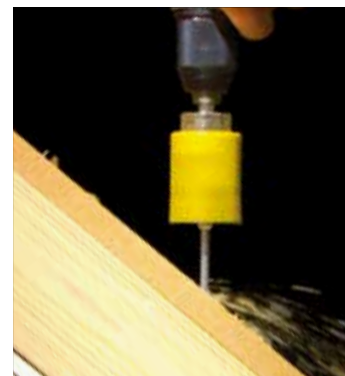

Zagen onder een extreme hoek



Alle houtsoorten



Wandtegels



MDF



Trespa & kunststof



Gips en gasbeton

Pro-fit Multipurpose Gatzaag, Systeemkoffer

16-82 mm 16 delig

Art.nr. 5964 063 250

VE/st. 1



Profit hartmetalen gatzaag

Art.nr. 0632 500 ...

VE/st. 1



Diamant-dozenboor H70-S steen

Art.nr. 0666 620 082

VE/st. 1



















Diamant-dozenboor U90 beton

Art.nr. 0666 635 082

VE/st. 1



WÜRTH BARCODE DECOUPEERZAAGBLADEN

<p> 4 0 2 4 8 3 5 8 9 5 6 7 5</p> <p>0608116234 VE 1 Decoupeerzaagblad, hout DECOUPEERZGBL MULTIBLADE 90MM HOUT 5S</p>	<p></p>	<p> 4 0 2 4 8 3 5 8 9 5 6 8 2</p> <p>0608116345 VE 1 Decoupeerzaagblad, bouw DECOUPEERZAAGBL MULTI BLADE UNI/BI 5ST.</p>	<p></p>
<p> 4 0 3 8 8 9 8 0 4 9 1 0 4</p> <p>060811691 VE 1 Decoupeerzaagblad, hout DECOUPEERZGBL HOUT(72/4,0MM)-5ST.</p>	<p></p>	<p> 4 0 3 8 8 9 8 4 1 0 8 9 8</p> <p>061505020 VE 1 Decoupeerzaagblad metaal ZEBRA HSS BIMETAAL DECOUPEERZAAG 5ST.</p>	<p></p>
<p> 4 0 3 8 8 9 8 4 1 0 9 4 2</p> <p>061509025 VE 1 Decoupeerzaagblad, bouw DECOUPEERZGBL BOUW(90/2,5MM)-5ST.</p>	<p></p>	<p> 4 0 3 8 8 9 8 4 1 0 8 1 2</p> <p>0608116099 VE 1 Decoupeerzaagblad, hout DECOUPEERZGBL HOUT(75/3,0MM)-5ST.</p>	<p></p>
<p> 4 0 4 6 7 7 8 8 5 9 7 2</p> <p>0696121110 VE 1 Starlock zaagblad, dubbel getand ZAAGBLAD-MULTI-STARLOCK-D32MMX50MM</p>	<p></p>	<p> 4 0 5 8 8 0 7 4 0 2 3 5 2</p> <p>0696123110 VE 1 Starlock Max zaagblad, enkel getand, koz... ZGBLD-MULTI-STARLOCK-MAX-52MMX70MM</p>	<p></p>
<p> 4 0 5 6 8 0 7 4 0 2 3 5 2</p> <p>0696123120 VE 1 Starlock Max hardmetalen zaagblad, enkel... ZGBLD-MULTI-STARLOCK-MAX-32MMX70MM</p>	<p></p>		

EEN KLIK – NU MET STARLOCK

<p>STARLOCK</p>  <p>Voor algemene toepassingen</p>	<p>STARLOCK PLUS</p>  <p>Voor zware toepassingen</p>	<p>STARLOCK MAX</p>  <p>Voor extreme toepassingen</p>
---	--	---

Het opnamesysteem voor de multitoel is in drie prestatieklassen onderverdeeld en is voor elke professional onmisbaar, hetzij voor de elektriciens, timmerman, loodgieter, stoffeerder enz.

U bereikt nauwkeurige resultaten, hoge snijnsnelheid en bespaart veel tijd door het snelle opnamesysteem zonder dat daar enige gereedschappen aan te pas komt.

Kleuren coderingssysteem Starlock opname

Door de drie duidelijk gescheiden kleuren vindt u altijd het juiste zaagblad voor uw toepassing.

Bouw/ universeel	Metaal	Hout

DECOUPEERZAAGBLADEN

Decoupeerzaagblad Hout

Spaanplaat, hardhout, zachte houtsoorten en PVC

- fijne zaagsnede • snel • 100 mm lang • goede kwaliteit

Art.nr. 0608 116 91

VE/st. 5



Decoupeerzaagblad Hout

Multiplex, spaanplaat, hardhout, zachte houtsoorten en PVC

- ook geschikt voor dun materiaal • lange levensduur • fijne zaagsnede • snel • 117 mm lang • premium

Art.nr. 0608 116 234

VE/st. 5



Decoupeerzaagblad Universeel

Hout, ook met spijkers, staal, aluminium, PVC en kunststoffen

- snel • 132 mm lang • lange levensduur • premium

Art.nr. 0608 116 345

VE/st. 5



Decoupeerzaagblad Universeel

Hout, ook met spijkers, hard metaal

- dun materiaal • 132 mm lang • goede kwaliteit

Art.nr. 0615 090 25

VE/st. 5



Decoupeerzaagblad Metaal

Alle metalen en harde kunststoffen

- snel • 91 mm lang • lange levensduur • premium

Art.nr. 0615 050 20

VE/st. 5



Decoupeerzaagblad Hout

Hout

- 100 mm lang • basic

Art.nr. 0608 116 099

VE/st. 5



Decoupeerzagenset

Assortiment voor de bouw

5 x 3 decoupeerzagen
(modellen staan hiernaast afgebeeld)

Art.nr. 0608 115 012

VE/st. 1



WÜRTH BARCODE

SCHROBZAAGBLADEN/RECIPROZAGEN



0615720332 VE 1
Schrobzaagblad Bouw
SCHROBZAAGBL.HEAVY DUTY BOUW 200MM 5



0615815030 VE 1
Schrobzaagblad Hout
SCHROBZAAGBL.BI-MET 150MM 3 MM 5ST.



0615830040 VE 1
Schrobzaagblad Hout
BI-SCHROBZAAG HOUT 300 MM T 4MM 5ST.



0615915030 VE 1
Schrobzaagblad Metaal
SCHROBZAAGBL.MULTIBLADE MET. 150 MM 5S



0615715254 VE 1
Schrobzaagblad Bouw
SZB-BOUW-3STK-LL-MULTIBLADE-150X2,5-4,0



0615730254 VE 1
Schrobzaagblad Bouw
SZB-BOUW-3STK-LL-MULTIBLADE-305X2,5-4,0



0615720346 VE 1
Schrobzaagblad Bouw
SCHROBZAAGBL.MULTIBLADE BOUW 200 MM 5



0615820340 VE 1
Schrobzaagblad Hout
SCHROBZAAGBL.MULTIBLADE HOUT 200 MM 5:



0615915029 VE 1
Schrobzaagblad Metaal
SCHROBZAAGBL.DEMOLITION MET. 150 MM 5S



0615922829 VE 1
Schrobzaagblad Metaal
SCHROBZAAGBL.DEMOLITION MET. 228 MM 5S



0615722842 VE 1
Schrobzaagblad Bouw
SZB-BOUW-5STK-DEMOLITION-228X4,2

Schrobzaagblad Bouw

Voor het zagen van hout met spijkers, palletbouw, sandwichmaterialen, gipsplaat, schurende materialen

- Extreem lange levensduur

Art.nr. 0615 722 842

VE/st.



Schrobzaagblad Bouw

Voor het zagen van hout met spijkers, palletbouw, sandwichmaterialen, gipsplaat, schurende materialen

- Extreem lange levensduur

Art.nr. 0615 730 254

VE/st.



Schrobzaagblad Bouw

Voor het zagen van hout met spijkers, palletbouw, sandwichmaterialen, gipsplaat, schurende materialen

- Extreem lange levensduur

Art.nr. 0615 715 254

VE/st.



SCHROBZAAGBLADEN/RECIPROZAGEN

Schrobzaagblad Hout

Spaanplaat, hardhout, zachte houtsoorten, multiplex

- fijne zaagsnede • snel • 200 mm lang • premium

Art.nr. 0615 820 340

VE/st. 5



Schrobzaagblad Hout

Hout met metaal en oude kozijnen verwijderen

- 150 mm lang • premium

Art.nr. 0615 815 030

VE/st. 5



Schrobzaagblad Hout

Spaanplaat, hardhout, zachte houtsoorten en multiplex

- snel • 305 mm lang • goede kwaliteit

Art.nr. 0615 830 040

VE/st. 5



Schrobzaagblad Metaal

Leidingen en profiel doorzagen

- ook dikkere platen • 150 mm lang • premium

Art.nr. 0615 915 029

VE/st. 5



Schrobzaagblad Metaal

Universeel, leidingen en profielen, alu, koper en zink

- 150 mm lang • premium

Art.nr. 0615 915 030

VE/st. 5



Schrobzaagblad Metaal

Stalen leidingen en plaatwerk

- sloopwerk • 228 mm lang • premium

Art.nr. 0615 922 829

VE/st. 5



Schrobzaagblad Bouw

Houtwerk, multiplex, aluminium, PVC, glasvezel, hout met spijkers/metaal

- 200 mm lang • premium

Art.nr. 0615 720 346

VE/st. 5

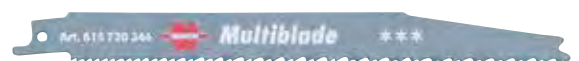

Schrobzaagblad Bouw

Zwaar zaagwerk, hout met spijkers/metaal, gips gelijmde houtplaten

- 200 mm lang • goede kwaliteit

Art.nr. 0615 720 332

VE/st. 5



WÜRTH BARCODE CIRKELZAAGBLADEN

 0610160400 VE 1 Zaagblad handcirkelzaag CIRKELZAAGBLAD HOUT 160MM 40T ASGAT20M	
 0610160480 VE 1 Zaagblad handcirkelzaag, 160 mm, asgat 20 mm, 48 tanden	
 0611540028 VE 1 Cirkelzaagblad bouwplaats C.ZGBL.-BOUW-HM-TZ-400X28X30	
 0611550036 VE 1 Cirkelzaagblad bouwplaats C.ZGBL.-BOUW-HM-TZ-500X36X30	

 0611625042 VE 1 UNI-Top cirkelzaagblad UNI-TOP CIRKELZGBLD 250X3,0X30 T42	
 0610160520 VE 1 Zaagblad handcirkelzaag, 160 mm, asgat 20 mm, 52 tanden	
 0611545032 VE 1 Cirkelzaagblad bouwplaats C.ZGBL.-BOUW-HM-TZ-450X32X30	

CIRKELZAAGBLADEN

Cirkelzaagblad bouwplaats

Voor grove werkzaamheden op bouwplaatsen

Ø400 mm, asgat 30 mm

Art.nr. 0611 540 028

Ø450 mm, asgat 30 mm

Art.nr. 0611 545 032

Ø500 mm, asgat 30 mm

Art.nr. 0611 550 036

VE/st. 1



Cirkelzaagblad handcirkelzaag

Zacht- en hardhout & spaanplaat
Handcirkelzaag, 40 tanden

Ø160 mm, asgat 20 mm, 40 tanden

Art.nr. 0610 160 400

VE/st. 1

Ø160 mm, asgat 20 mm, 48 tanden

Art.nr. 0610 160 480

VE/st. 1

Ø160 mm, asgat 20 mm, 52 tanden, negatief

Art.nr. 0610 160 520

VE/st. 1



Cirkelzaagblad

Voor handcirkelzaag, maar ook voor
tafelzaagmachines en afkortmachines,
42 tanden

- **Langdurig inzet in hout**
(metaal en kunststof kortstondig)

Ø250 mm, asgat 30 mm

Art.nr. 0611 625 042

VE/st. 1

**Ook verkrijgbaar in
Ø150 t/m Ø450 mm**



WÜRTH BARCODE BITS & BITHOUDERS

	<p>0614176274 VE 10 Phillipsbit BIT, 25MM, 1/4", KRUIS, PH1</p>	
	<p>0614176638 VE 1 1/4" bithouder, magnetisch ONE TOUCH BITH.MAGN-1/4IN-L66MM</p>	
	<p>0614176651 VE 10 Phillipsbit BIT, 25MM, 1/4", KRUIS, PZ1</p>	
	<p>0614176653 VE 10 Phillipsbit BIT, 25MM, 1/4", KRUIS, PZ3</p>	
	<p>0614176702 VE 1 Universele houder E 6,3 (1/4) rvs magnee... BITHOUDER - HULS, 1/4, 74MM</p>	
	<p>061470 10 VE 10 RW®-bit BIT-RW10-PAARS-1/4ZO-L25MM</p>	
	<p>061470 25 VE 10 RW®-bit BIT-RW25-LICHTGROEN-1/4ZO-L25MM</p>	
	<p>061470 40 VE 10 RW®-bit BIT-RW40-LICHTPAARS-1/4ZO-L25MM</p>	
	<p>0614811360 VE 1 Univ. houder E 6,3 (1/4) snelwissel inst... BITHOUDER, MAGN., 1/4", 60MM</p>	

	<p>0614176461 VE 10 Phillipsbit BIT, 25MM, 1/4", KRUIS, PH2</p>	
	<p>0614176648 VE 10 Phillipsbit BIT, 25MM, 1/4", KRUIS, PH3</p>	
	<p>0614176652 VE 10 Phillipsbit BIT, 25MM, 1/4", KRUIS, PZ2</p>	
	<p>0614176690 VE 1 Universele houder E 6,3 (1/4) rvs magnee... BITHOUDER + HULS, 1/4", 45MM</p>	
	<p>0614176758 VE 1 Universele houder E 6,3 (1/4) rvs magnee... HALT-BIT-HUE/SPRRG-MAGN-1/4ZO-L175MM</p>	
	<p>061470 20 VE 10 RW®-bit BIT-RW20-LICHTORANJE-1/4ZO-L25MM</p>	
	<p>061470 30 VE 10 RW®-bit BIT-RW30-LICHTGEEL-1/4ZO-L25MM</p>	
	<p>061470 50 VE 5 RW®-bit BIT-RW50-LICHTTUERKIS-5/16ZO-L50MM</p>	

Bithouder universeel

74 mm lang, magnetisch, huls 1/4"

Art.nr. 0614 176 702

VE/st. 1



BITS & BITHOUDERS

POZIDRIV®

BIT Pozidriv® PZD 1

PZ 1 - 25 mm - 1/4"

Art.nr. 0614 176 651

VE/st. 10



BIT Pozidriv® PZD 2

PZ 2 - 25 mm - 1/4"

Art.nr. 0614 176 652

VE/st. 10



BIT Pozidriv® PZD 3

PZ 3 - 25 mm - 1/4"

Art.nr. 0614 176 653

VE/st. 10



PHILLIPS

BIT Phillips PH 1

PH 1 - 25 mm - 1/4"

Art.nr. 0614 176 274

VE/st. 10



BIT Phillips PH 2

PH 2 - 25 mm - 1/4"

Art.nr. 0614 176 461

VE/st. 10



BIT Phillips PH 3

PH 3 - 25 mm - 1/4"

Art.nr. 0614 176 648

VE/st. 10



ASSY® RW-AANDRIJVING

RW/ASSY® RW20

RW20 - 25 mm - 1/4"

Art.nr. 0614 70 20

VE/st. 10



RW/ASSY® RW30

RW30 - 25 mm - 1/4"

Art.nr. 0614 70 30

VE/st. 10



RW/ASSY® RW10

RW30 - 25 mm - 1/4"

Art.nr. 0614 70 10

VE/st. 10



RW/ASSY® RW25

RW25 - 25 mm - 1/4"

Art.nr. 0614 70 25

VE/st. 10



RW/ASSY® RW40

RW40 - 25 mm - 1/4"

Art.nr. 0614 70 40

VE/st. 10



RW/ASSY® RW50

RW50 - 50 mm - 5/16"

Art.nr. 0614 70 50

VE/st. 10



Bithouder

Magnetisch, huls 1/4"

45 mm Art.nr. 0614 176 690

175 mm Art.nr. 0614 176 758

VE/st. 1



Bithouder

Magneet, one touch, ontgrendelknop, 66 mm

Art.nr. 0614 176 638

VE/st. 1



Bithouder

Instelbare diepte, 60 mm

Art.nr. 0614 811 360

VE/st. 1



WÜRTH BARCODE BITJES & BITHOUDERS



0614202 VE 1
Bitset met metalen riemclip
BITSET MET RIEMCLIP



0614203 VE 1
Bitset met metalen riemclip
BITSET, 1/4", GEM, 17-TLG



0614400103 VE 1
Bitbox, maat 2 9-delig
BITBOX-PH-1/2/3-ZS-0,8-9DLG.-GR1



0614250030 VE 1
Bitbox C 6,3 (1/4) 31-delig bithouder
BIT-MIX-SET-IMP-PH/PZ/TX-8PCS



0614400204 VE 1
Bitbox, maat 2 17-delig
BITBOX-PH-PZD-TX-ZS-17DLG.-GR2



0614400106 VE 1
Bitbox, maat 1 9-delig
BITBOX-TX10/15/20/25/30/40-9DLG.-GR1



06143110 VE 10
TX-bit
BIT, 25MM, 1/4", TX10



061425020 VE 1
Bitdoos met bits
BITBOX, 1/4"GEM, 9-TLG



06143120 VE 10
TX-bit
BIT, 25MM, 1/4", TX20



06143115 VE 10
TX-bit
BIT, 25MM, 1/4", TX15



06143130 VE 10
TX-bit
BIT, 25MM, 1/4", TX30



06143125 VE 10
TX-bit
BIT, 25MM, 1/4", TX25



0614400301 VE 1
Bitbox
BITSET-33 DLG.



06143140 VE 10
TX-bit
BIT, 25MM, 1/4", TX40



BITJES & BITHOUDERS

TORX

BIT Torx TX10

TX10 - 25 mm - 1/4"

Art.nr. 0614 311 0
VE/st. 10



BIT Torx TX15

TX15 - 25 mm - 1/4"

Art.nr. 0614 311 5
VE/st. 10



BIT Torx TX20

TX20 - 25 mm - 1/4"

Art.nr. 0614 312 0
VE/st. 10



BIT Torx TX25

TX25 - 25 mm - 1/4"

Art.nr. 0614 312 5
VE/st. 10



BIT Torx TX30

TX30 - 25 mm - 1/4"

Art.nr. 0614 313 0
VE/st. 10



BIT Torx TX40

TX40 - 25 mm - 1/4"

Art.nr. 0614 314 0
VE/st. 10



ASSORTIMENTEN

Bitbox, maat 2 17-delig

Uitgebreid assortiment met PH, PZ, TX, en sleufkopbits in verwisselbare bitstukken inclusief bithouder.

Art.nr. 0614 400 204
VE/st. 1



Bitbox 33-delig met o.a. RW-bits

8x RW, 4x PH, 5x PZ, 8x TX, 4x binnenzeskant, 3x zaagsnede en 1 universele bithouder

Art.nr. 0614 400 301
VE/st. 1



Diverse sets bit en bithouders

Art.nr. 0614



WÜRTH BARCODE SCHROEVENDRAAIERS

0613200035 VE 1
Schroevendraaier 3-componenten
SCHROEVENDRAAIER, GLEUF, 0, 6X3, 5MM

B1

061320007 VE 1
Schroevendraaier 3-componenten
SCHROEVENDRAAIER, GLEUF, 1, 2X7, 0MM

B3

06132022 VE 1
PZ-schroevendraaier, zeskant-kling, stoo...
SCHROEVENDRAAIER, KRUISKOP, PZ2

B5

0613231065 VE 1
Sleufkopschroevendraaier ronde kling
SCHROEVENDRAAIER, GLEUF, 1, 2X6, 5MM

A3

0613231735 VE 1
Sleufkopschroevendraaier ronde kling sma...
SCHROEVENDRAAIER, GLEUF, 0, 6X3, 5MM

A1

061323202 VE 1
Schroevendraaier PH ronde kling
SCHROEVENDRAAIER, KRUISKOP, PH2

A7

06132332 VE 1
PZ-schroevendraaier ronde kling
SCHROEVENDRAAIER, KRUISKOP, PZ2

A5

061325105 VE 1
Sleufkopschroevendraaier ronde kling kor...
SCHROEVENDRAAIER, GLEUF, 1X5, 5MM

06132532 VE 1
PZ-schroevendraaier ronde kling, kort
SCHROEVENDRAAIER, KRUISKOP, PZ2

061392335 VE 1
Schroevendr.set, ronde kling, PZ/sleuf, ...
SCHROEVENDRAAIERSET, PZ, 5-TLG

SET A

0613200055 VE 1
Schroevendraaier 3-componenten
SCHROEVENDRAAIER, GLEUF, 1, 0X5, 5MM

B2

06132021 VE 1
PZ-schroevendraaier, zeskant-kling, stoo...
SCHROEVENDRAAIER, KRUISKOP, PZ1

B4

0613231055 VE 1
Sleufkopschroevendraaier ronde kling
SCHROEVENDRAAIER, GLEUF, 1X5, 5MM

A2

061323112 VE 1
Sleufkopschroevendraaier ronde kling
SCHROEVENDRAAIER, GLEUF, 1, 6X12MM

061323201 VE 1
Schroevendraaier PH ronde kling
SCHROEVENDRAAIER, KRUISKOP, PH1

A6

06132331 VE 1
PZ-schroevendraaier ronde kling
SCHROEVENDRAAIER, KRUISKOP, PZ1

A4

0613247360 VE 1
Eenpolige spanningzoeker
SPANNINGSTESTER, EINPPL, DIN57680/T6

06132522 VE 1
Schroevendraaier PH ronde kling kort
SCHROEVENDRAAIER, KRUISKOP, PH2

06139025 VE 1
Schroevendraaierset
SCHROEVENDRAAIERSET, PZ, 5-TLG

SET B

071534 010 VE 1
Kleine schroevendraaier met zakclip
KLEINE SCHROEVENDRAAIER

HANDGEREEDSCHAP SCHROEVENDRAAIERS

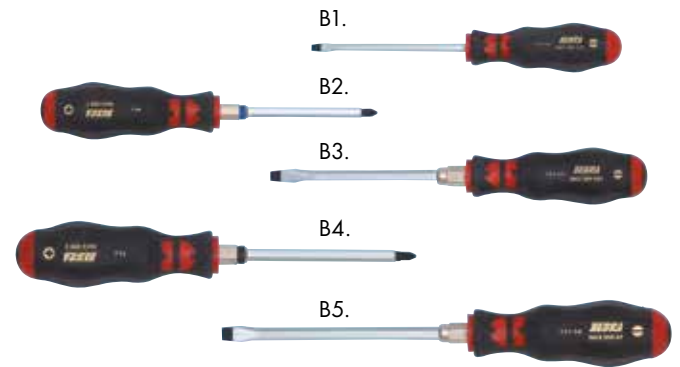
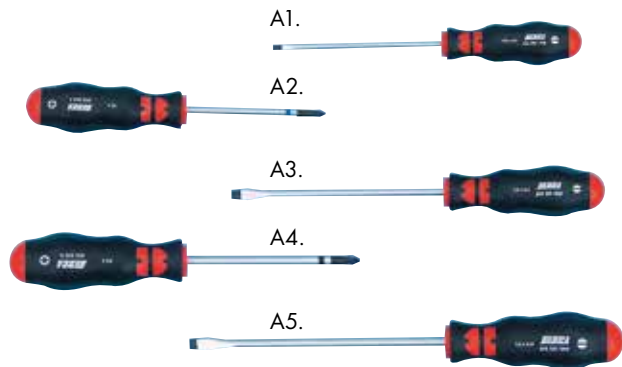

Schroevendraaierset A

- A1. zaagsnede 0,6 x 3,5 **Art.nr. 0613 231 735**
- A2. zaagsnede 1,0 x 5,5 **Art.nr. 0613 231 055**
- A3. zaagsnede 1,2 x 6,5 **Art.nr. 0613 231 065**
- A4. Pozidriv® PZD1 **Art.nr. 0613 233 1**
- A5. Pozidriv® PZD2 **Art.nr. 0613 233 2**

Art.nr. set 0613 923 35
VE/st. 1

Schroevendraaierset B

Premium • 3K softgrip • zeskantkling • sleutelhulp
• voorzien van slagplaat

- B1. zaagsnede 0,6 x 3,5 **Art.nr. 0613 200 35**
- B2. zaagsnede 1,0 x 5,5 **Art.nr. 0613 200 055**
- B3. zaagsnede 1,2 x 7,0 **Art.nr. 0613 200 07**
- B4. Pozidriv® PZD1 **Art.nr. 0613 202 1**
- B5. Pozidriv® PZD2 **Art.nr. 0613 202 2**

Art.nr. set 0613 902 5 VE/st. 1

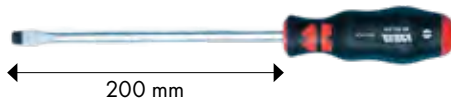

Schroevendraaier Phillips, kruiskop

- A6. PH1 **Art.nr. 0613 232 01**
 - A7. PH2 **Art.nr. 0613 232 02**
- VE/st. 1

Schroevendraaier, lang

Zaagsnede 1,6 x 12
Art.nr. 0613 231 12
VE/st. 1

Schroevendraaier, korte uitvoering, STUBBY

- PH2 kruiskop **Art.nr. 0613 252 2**
 - PZD2 Pozidriv® **Art.nr. 0613 253 2**
 - 1,2 x 5,5 zaagsnede **Art.nr. 0613 251 05**
- VE/st. 1

Kleine schroevendraaier, fittingschroevendraaier

Zaagsnede 0,4 x 2,5
Art.nr. 0715 34 010
VE/st. 1

Spanningzoeker

Art.nr. 0613 247 360
VE/st. 1



WÜRTH BARCODE

DOPSLEUTELSETS & VERSTELBARE SCHROEFSLEUTEL



0712131113 VE 1
Dopsleutel 1/2 inch, zeskant, kort
STEEKSLEUTELINZETSTUK 1/2 , MET, 13MM



0712131119 VE 1
Dopsleutel 1/2 inch, zeskant, kort
STEEKSLEUTELINZETSTUK 1/2 , MET, 19MM



071522108 VE 1
Verstelbare steeksleutel
SCHROEFSLEUTEL VERSTELB. 8 INCH



096511 32 VE 1
Dopsleutelset 1/4 inch, 33-dlg.
DOPPENDOOS 1/4 AANSL. 32-DLG.



0712131117 VE 1
Dopsleutel 1/2 inch, zeskant, kort
STEEKSLEUTELINZETSTUK 1/2 , MET, 17MM



0712133117 VE 1
Dopsleutel 1/2 inch, twaalfkant, kort
DOPSLEUTEL 1/2" AANSL 17MM 12KNT



071522110 VE 1
Verstelbare steeksleutel
SCHROEFSLEUTEL VERSTELB. 10 INCH



096513 20 VE 1
Dopsleutelset 1/2 inch twaalfkant, 21-dl...
DOPSLEUTELSET 1/2 AANSL.21 DLG 12KT



HANDGEREEDSCHAP

DOPSLEUTELSETS & VERSTELBARE SCHROEFSLEUTEL

Dopsleutelset 1/4"

32-delig

Inhoud:

- Omschakelbare ratel
- Cardangewricht
- Verlengstukken 100 en 150 mm
- Dopsleutels: SW4, 5, 5.5, 6, 7, 8, 9, 10, 11, 12, 13 & 14
- 14 bits
- Adapter met snelwissel-bithouder

Art.nr. 0965 11 32

VE/st. 1

Losse onderdelen staan in deksel



Dopsleutelset 1/2" twaalfkant

21-delig

Inhoud:

- Omschakelbare ratel
- Cardangewricht
- Verlengstukken 125 en 250 mm
- Dopsleutels: SW10, 11, 12, 13, 14, 15, 16, 17, 18, 19, 22, 24, 27, 30, 32, 34

Art.nr. 0965 13 20

VE/st. 1

Losse onderdelen staan in deksel



Verstelbare schroefsleutel

Lang 8" / 20,6 cm / tot 24 mm

Art.nr. 0715 221 08

Lang 10" / 25,7 cm / tot 29 mm

Art.nr. 0715 221 10

VE/st. 1



Dopsleutel zeskant 1/2" KORT

13 mm zeskant **Art.nr. 0712 131 113**

17 mm zeskant **Art.nr. 0712 131 117**

17 mm twaalfkant **Art.nr. 0712 133 117**

19 mm zeskant **Art.nr. 0712 131 119**

VE/st. 1

Andere doppen: **0712 .. / 0713 ..**



WÜRTH BARCODE

RINGSTEEKSLEUTELS, STIFTSLEUTELS & TANGEN



071330210 VE 1
Ringsteeksleutels
STEEKKRINGSLEUTEL, LANG, OMGEBOGEN,
10mm



071330216 VE 1
Ringsteeksleutels
STEEKKRINGSLEUTEL, LANG, OMGEBOGEN,
16mm



071330218 VE 1
Ringsteeksleutels
STEEKKRINGSLEUTEL, LANG, OMGEBOGEN,
18mm



071330221 VE 1
Ringsteeksleutels
STEEKKRINGSLEUTEL, LANG, OMGEBOGEN,
21mm



071330224 VE 1
Ringsteeksleutels
STEEKKRINGSLEUTEL, LANG, OMGEBOGEN,
24mm



0713851192 VE 1
Steigerbouwratelsleutel
DRAAGCONSTRUCTIERATEL, OMSCHAKELBAA



071401 555 VE 1
Combinatietang ZEBRA DIN ISO 5746
COMBINATIETANG, 180MM



071401 563 VE 1
Waterpomptang drukknoopverstelling 2C-gre...
ZEBRA WATERPOMPTANG ERGO 250 MM



071406 82 VE 1
Boutenschaar, andere
BOUTENSCHAAR BC 800 L-800



071502 06 VE 1 Moniertang,
250mm



071531 110 VE 1
Set haakse stiftsleutels
HAAKSE STIFTSLEUTEL SET, 10-TLG



071330213 VE 1
Ringsteeksleutels
STEEKKRINGSLEUTEL, LANG, OMGEBOGEN,
13mm



071330217 VE 1
Ringsteeksleutels
STEEKKRINGSLEUTEL, LANG, OMGEBOGEN,
17mm



071330219 VE 1
Ringsteeksleutels
STEEKKRINGSLEUTEL, LANG, OMGEBOGEN,
19mm



071330222 VE 1
Ringsteeksleutels
STEEKKRINGSLEUTEL, LANG, OMGEBOGEN,
22mm



071330250 VE 1
Ringsteeksleutels, gebogen, assortiment,...
STEEKKRINGSLEUTELSET, OMGEBOGEN, 9-TLG



071401 552 VE 1
Krachtzijkniptang, DIN ISO 5749
ZEBRA ZIJKNIPTANG 160 MM



071401 557 VE 1
Telefoontang DIN ISO 5745
VLAKKE RÓNDE TANG, 210MM



071401 565 VE 1
Tangenassortiment
TANGENSET, 4-TLG



071502 05 VE 1 Moniertang,
220mm

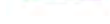

071502 07 VE 1 Moniertang,
280mm



071540 100 VE 1
Haakse stiftsleutelset, bolkop 9dlg



HANDGEREEDSCHAP

RINGSTEEKSLEUTELS, STIFTSLEUTELS & TANGEN

Ringsteeksleutels, gebogen



Assortiment 9-delig
10, 13, 16, 17, 18, 19, 21, 22 en 24

Art.nr. 0713 302 50

VE/st. 1

Losse ringsteeksleutels op barcodeblad



Haakse stift- sleutelset, lang



Kogelkopuitvoering

Assortiment 9-delig
1,5 t/m 10 mm

Art.nr. 0715 40 100

VE/st. 1



Haakse stift- sleutelset, kort



Assortiment 9-delig
1,5 t/m 10 mm

Art.nr. 0715 31 110

VE/st. 1



Tangenset

Inhoud:

Combinatietang 180 mm

Waterpomptang 250 mm

Telefoontang 160 mm

Krachtzijkniptang 160 mm

Art.nr. 0714 01 555

Art.nr. 0714 01 563

Art.nr. 0714 01 557

Art.nr. 0714 01 552

Art.nr. 0714 01 565

VE/st. 1



Moniertang

220 mm lang **Art.nr. 0715 02 05**

250 mm lang **Art.nr. 0715 02 06**

280 mm lang **Art.nr. 0715 02 07**

VE/st. 1



Boutenschaar, betonschaar

80 cm, 4,4 kg

Art.nr. 0714 06 82

VE/st. 1



Steigerbouwratelsleutel / werfpunratel

Omschakelaar, SW19 en SW22

Art.nr. 0713 851 192 VE/st. 1



WÜRTH BARCODE HANDZAGEN & IJZERZAGEN

<p>060330113 VE 10 HSS zaagblad Bimetall ZEBRA ZAAGBL.HHS BI MET.12 32-18T</p>	<p>4 0 1 1 2 3 1 4 9 8 3 2 6</p>
<p>0695552892 VE 1 Metaalbeugelzaag METAALZAAGBEUGEL</p>	<p>4 0 1 1 2 3 1 6 0 5 6 5 6</p>
<p>5760031030 VE 1 Handzaag Top HANDZAAG-2K-400MM</p>	<p>4 0 5 3 4 7 9 2 4 5 2 0 1</p>
<p>5760031036 VE 1 Handzaag, 1-C HANDZAAG-500MM-1C</p>	<p>4 0 5 3 4 7 9 2 4 5 1 1 9</p>
<p>5760031041 VE 1 Handzaag, Premium HANDZAAG-PREMIUM-500MM-2C</p>	<p>4 0 5 3 4 7 9 2 4 5 9 0 4</p>

<p>06092 VE 12 Klein zaagblad ZAAGBLÄD 6 TBV. STAAL</p>	<p>4 0 1 1 2 3 1 5 0 0 1 0 4</p>
<p>071464 03 VE 1 Universele minizaag UNIVERSELE ZAAG MINI</p>	<p>4 0 1 1 2 3 1 7 2 0 4 1 0</p>
<p>5760031034 VE 1 Fijnezaag, tweecomponenten FINEERZAAG-2K-325MM</p>	<p>4 0 5 3 4 7 9 2 4 5 2 9 4</p>
<p>5760031040 VE 1 Handzaag, Premium HANDZAAG-PREMIUM-400MM-2C</p>	<p>4 0 5 3 4 7 9 2 4 5 3 1 7</p>
<p>5760031905 VE 1 Isolatiezaag ISOLATIEZAAG-2K-500MM</p>	<p>4 0 4 6 7 7 1 3 1 9 4 9</p>

HANDGEREEDSCHAP HANDZAGEN & IJZERZAGEN

Handzaag 1K

Hoogwaardige handzaag met 1-component kunststof handvat voor nauwkeurige sneden in houtproducten.

Plaatlengte: 500 mm
Lengte: 580 mm

Art.nr. 5760 031 036

VE/st. 1



Handzaag 2K Top

Plaatlengte: 400 mm
Lengte: 495 mm

Art.nr. 5760 031 030

VE/st. 1



Handzaag 2K Premium

Hoogwaardige handzaag met 2-componenten kurkhandgreep en speciaal gecoat blad.

Art.nr. 5760 031 040 Plaatlengte 400 mm

Art.nr. 5760 031 041 Plaatlengte 500 mm

VE/st. 1



Isolatiezaag 2K

Hoogwaardige isolatiezaag met 2-componenten-kurkhandgreep en speciale tanden voor het nauwkeurig zagen van isolatiematerialen.

Plaatlengte: 460 mm

Art.nr. 5760 031 905

VE/st. 1



Fineerzaag 2K

Hoogwaardige handzaag met 2-componentenhandgreep van kunststof en kurk, voor precies zagen in hout.

Plaatlengte: 325 mm

Art.nr. 5760 031 034

VE/st. 1



Beugelzaag mini

Art.nr. 0714 64 03

VE/st. 1



Losse zagen

145 mm, metaal

Art.nr. 0609 2

VE/st. 12

Ook voor hout verkrijgbaar **art.nr. 0609 3**



Metaalzaag, ijzerzaag

300 mm zaagblad

Art.nr. 0695 552 892

VE/st. 1



Losse zagen

bi-metaal progressief vertand

Art.nr. 0603 301 13

VE/st. 10



Zagen in inches:

12" = 300 mm / 15" = 375 mm /

9" = 475 mm / 20" = 500 mm /

22" = 550 mm

WÜRTH BARCODE **HAMERS & MOKERS**



0715732100 VE 1
Moker

VUISTHAMER, DT-VORM, **1000 GR**



0715732200 VE 1
Moker

VUISTHAMER, DT-VORM, **2000 GR**



9501015631
Klauwhamer
KLAUWHAMER

VE 1



071573 50 VE 1
Bankwerkershamer met steelbeschermhuls
BANKWERKERSHAMER, DT-VORM, 500G



0715732150 VE 1
Moker

VUISTHAMER, DT-VORM, **1500 GR**



HANDGEREEDSCHAP **HAMERS & MOKERS**

Klauwhamer

Stanley FatMax, kop 450 gram, stalen steel,
Anti Vibe, Next Gen

Art.nr. 0997 644 372

VE/st. 1



Klauwhamer

Stanley, Blue Strike, kop 450 gram, stalen steel

Art.nr. 0997 644 371

VE/st. 1



Bankhamer

Kop 500 gram, steelbeschermering

Art.nr. 0715 73 50

VE/st. 1



Klauwhamer

Gewicht zonder greep 560 gram, stalen steel

Art.nr. 9501 015 631

VE/st. 1



Moker, vuistje

1000 gram, steel 26 cm

Art.nr. 0715 732 100

1500 gram, steel 28 cm

Art.nr. 0715 732 150











2000 gram, steel 30 cm

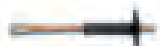









Art.nr. 0715 732 200

VE/st. 1



WÜRTH BARCODE BEITELS

<p>071463 04 VE 1 Vlakke beitel Volgens DIN 6453 VLAKBEITEL, 25MM</p>	 
<p>071463 36 VE 1 Steenbeitel STEENBEITEL</p>	 
<p>0715653400 VE 1 Steekbeitelset 2C, 6-delig STEEKBEITELSET, 2K, 6-TLG</p>	 
<p>0715653416 VE 1 Steekbeitel 2-componenten handgreep STEEKBEITEL, 2K, 16MM</p>	 
<p>0715653424 VE 1 Steekbeitel 2-componenten handgreep STEEKBEITEL, 2K, 24MM</p>	 
<p>0715653430 VE 1 Steekbeitel 2-componenten handgreep STEEKBEITEL, 2K, 30MM</p>	 

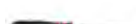
<p>071463 02 VE 1 Vlakke beitel Volgens DIN 6453 VLAKBEITEL, 18MM</p>	 
<p>071463 35 VE 1 Carrosseriebeitel CARROSSERIEBEITEL</p>	 
<p>071463 37 VE 1 Voegenbeitel VOEGBEITEL</p>	 
<p>0715653410 VE 1 Steekbeitel 2-componenten handgreep STEEKBEITEL, 2K, 10MM</p>	 
<p>0715653420 VE 1 Steekbeitel 2-componenten handgreep STEEKBEITEL, 2K, 20MM</p>	 
<p>0715653426 VE 1 Steekbeitel 2-componenten handgreep STEEKBEITEL, 2K, 26MM</p>	 

HANDGEREEDSCHAP BEITELS

Sleufbeitel

23 cm lang, breed 26 mm

Art.nr. 0714 63 35

VE/st. 1



Koudbeitel

15 cm lang, breed 18 mm

Art.nr. 0714 63 02

VE/st. 1



Breekbeitel

25 cm lang, breed 50 mm

Art.nr. 0714 63 37

VE/st. 1



Steenbeitel

30 cm lang, breed 26 mm

Art.nr. 0714 63 36

VE/st. 1



Koudbeitel

20 cm lang, breed 25 mm

Art.nr. 0714 63 04

VE/st. 1



Steekbeitelset

2 componenten greep, metalen slagkap, anti slip

Inhoud:

Beitelbreedte 10, 16, 20, 24, 26 en 30 mm

Art.nr. 0715 653 400

VE/st. 1

Losse beitels op barcodeblad



WÜRTH BARCODE **MESSEN**



071566 013 VE 1
Veiligheidsmes
2K-VEILIGHEIDSMES



071566 021 VE 10
Bi-metalen mes
BLAD-MES-TRAPEZE-BIMETAL-61MM



071566 210 VE 1
IC mes met geleiding
AFBREEKMES 18 MM



071566 051 VE 50
Afbreekmesbladen voor snijmes in houder
MESJES TBV 0715 66 04 HOBBYMES



071566 275 VE 1
Snijmes
2K-CUTTERMES, 18MM



0874110004 VE 1
Mes gekarteld



071566 02 VE 10
Trapezium mes
TRAPEZIUMMES 60MM TBV 0715 66 01



071566 03 VE 10
Haakmes
HAAKKLING IN DISPENSER



071566 05 VE 10
Afbreekmesbladen voor snijmes in houder
AFBREEKBLAD, 18MM



071566 053 VE 10
Afbreekmessen
AFBREEKBLAD, 18MM, BIJZONDER SCHERP



0874110001 VE 1
Mes glad



HANDGEREEDSCHAP **MESSEN**

Mes

Basis afbreekmes 18 mm

Art.nr. 0715 66 210

VE/st. 1



Mesjes



Basis, 18 mm

Art.nr. 0715 66 05

Extreem scherp, 18 mm

Art.nr. 0715 66 053

VE/st. 10

Mes

Afbreekmes 18 mm,
2 componentengreep,
incl. 3x mesje extreem scherp

Art.nr. 0715 66 275

VE/st. 1

Veel andere modellen verkrijgbaar
(9 mm & 25 mm) **art.nr. 0715 66 ...**



Mesjes

Basis, 18 mm, houder met 50 stuks

Art.nr. 0715 66 051

VE/st. 50



Veiligheidsmes

Mes schuift automatisch terug in handgreep,
incl. bi-metaal mes

Art.nr. 0715 66 013

VE/st. 1



Mesjes

Trapezium 60 mm

Art.nr. 0715 66 02

VE/st. 10



Mes, glad

Snijden isolatiemateriaal, rubber, pur, folie
31 cm lang, eenzijdig glad, incl. meshouder

Art.nr. 0874 110 001

VE/st. 1



Mesjes

Bi-metaal, scherper, nagenoeg onbreekbaar,
gaat langer mee

Art.nr. 0715 66 021

VE/st. 10



Mes, gekarteld

Snijden isolatiemateriaal, glaswol en steenwol
31 cm lang, gegolfd, incl. meshouder

Art.nr. 0874 110 004

VE/st. 1

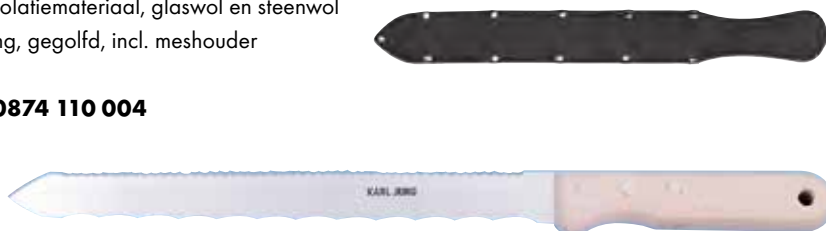

Haakmesjes

Art.nr. 0715 66 03

VE/st. 10



WÜRTH BARCODE **MESSEN**



071566 01 VE 1
Tapijtnes
UITSCHUIFBAAR MES



071566 28 VE 1
Snijmes met 2-componentenhandgreep
SNIJMES MET AFBREEKMES 25MM



071566 351 VE 10
Afbreekmes
AFBREEKBLAD, 25MM



HANDGEREEDSCHAP **MESSEN**

Snijmes

- Met slanke, zeer robuuste metalen handgreep
- Geschikt voor verschillende snijdieptes
- Instelbaar blad met 3 stopposities



Art.nr. 0715 66 01

VE/st. 1

Snijmes

- 2-componenten antislip-handgreep
- Robuuste uitvoering
- Automatische mesbevestiging



Art.nr. 0715 66 28

VE/st. 1

Mesjes

- Standaard, 25 mm



Art.nr. 0715 66 351

VE/st. 10

WÜRTH BARCODE LASERS



0714649210 VE 1
Statief 1/4 in hoogte verstelbaar
STATIEF 1/4 TBV WDM 200 / WDM 201



0714649303 VE 1
Statief 5/8 in hoogte verstelbaar
ALU STATIEF 95-269CM TBV LASER



5709300041 VE 1
Kruislijnlaser CLLG 18
KRUISLIJNLASER CLG 18



5709300305 VE 1
Rotatielaser RL5-14
ROTATIE LASER-RL5-14



5709300110 VE 1
Multilijnlaser MLLG 18
MULTILIJNLASER MLLG 18



5709300115 VE 1
Multilijnlaser MLPR 22
MULTILIJNLASER-MLPR 22



5709300454 VE 1
Universele laserontvanger LRU 22
UNIVERSELE-LASERONTVANGER-LRU22



0714649302 VE 1
Statief 5/8 met vlakke kop
STATIEF-LT-ALU-(L90-170CM)



5709300021 VE 1
Kruislijnlaser CLL 18
KRUISLIJNLASER CLL 18



5709300222 VE 1
Puntlijnlaser PLL 18
PUNTLIJNLASER PLL 18



5709300111 VE 1
Multilijnlaser MLL 18R
MULTILIJNLASER MLL 18R



5709300451 VE 1
Laserontvanger LR5-14
LASERONTVANGER-LR5-14



5709300515 VE 1
Laserafstandsmeter WDM 8-14
LASERAFSTANDSMETER - WDM8-14



5709300523 VE 1
Laserafstandsmeter WDM 3-19
LASERAFSTANDSMETER WDM 3-19



5709300116 VE 1
Multilijnlaser MLPG 22
MULTILIJNLASER-MLPG 22



5709300516 VE 1
Laserafstandsmeter WDM 6-22
LASERAFSTANDSMETER-WDM 6-22



LASERS

Compacte multilijnlasers

Zelfnivellerende multilijnlaser met 3 groene, zeer goed zichtbare 360°-laserlijnen

Art.nr. 5709 300 115 Rood (25 m)
 Art.nr. 5709 300 116 Groen (35 m)
 VE/st. 1



Statief, aluminium

5/8" vlakke kop, 90 - 170 cm

Art.nr. 0714 649 302
 VE/st. 1



Rotatielasers

Art.nr. 5709 300 30.
 VE/st. 1



Laserafstandsmeter

WDM 6-22

Zeer nauwkeurige laserafstandsmeter met Bluetooth® en digitale waterpas

- Afstand meten tot 150 m

Art.nr. 5709 300 516
 VE/st. 1



Laserzichtbril

Art.nr. 5709 300 915
 VE/st. 1



Kruislijnlaser CLL 18

Rode laser, zelfnivellerend, 180°, 2 lasers

Art.nr. 5709 300 021
 VE/st. 1



Kruislijnlaser CLG 18

Groene laser, zelfnivellerend, 180°, 2 lasers, 4x beter zichtbaar

Art.nr. 5709 300 041
 VE/st. 1



Puntlijnlaser PLL 18

Rode laser, zelfnivellerend, 180°

Art.nr. 5709 300 222
 VE/st. 1



ELEKTRISCH GEREEDSCHAP

Schrobzaagmachine

SBS 1300-VES

4,2 kg, 1300 Watt, 32 mm slaglengte
Incl. 5 zaagbladen en koffer

Art.nr. 0702 695 1

VE/st. 1



Schrobzaagmachine

SBS 1100-E

3,2 kg, 1100 Watt, 19 mm slaglengte
Incl. 5 zaagbladen en koffer

Art.nr. 5706 540 1 VE/st. 1

Let op! Lichtere uitvoering



Handcirkelzaagmachine HKS 86-2

Incl. zaagblad Ø 235 mm

Art.nr. 0702 187 0

VE/st. 1



Afkort- en verstekzaagmachine

KGS 270-60 E

Zeer compacte en lichtgewicht afkort- en verstekzaag met elektronische regeling van het motortoerental, schuif functie en krachtige 1550W-motor met 24-tands VHM zaagblad, montagegereedschap en werkstukkleem.

Art.nr. 0701 344 0

VE/st. 1



Haakse slijpmachine

EWS 24-230 S Master

Max Ø 230 mm, 2400 Watt, snelspanmoer

Art.nr. 0702 446 20

VE/st. 1



Haakse slijpmachine

EWS 10-125 compact

Ø 125 mm, 1000 Watt, standaard

Art.nr. 5707 003 0

VE/st. 1



ELEKTRISCH GEREEDSCHAP

Klopboormachine SB 13-XE

Art.nr. 0702 322 2

VE/st. 1



Excentrische schuurmachine ETS 150-E twin

Art.nr. 0702 129 0

VE/st. 1



Boorhamer H 26-MLS

Boormachine met beitelfunctie, 830 W, 2,9 kg, SDS-plus opname.

Wordt geleverd inclusief boren en koffer.

Art.nr. 5708 205 1

VE/st. 1



Boor-/hakhamer BMH 45 XE

1500 Watt, 8,9 kg, SDS-MAX

Incl. hamerboren en koffer

Art.nr. 0702 557 1

VE/st. 1



Decoupeerzaagmachine STP 140 EXACT B

Decoupeerzaag met beugelgreep, 720 Watt, 2,3 kg

Incl. 3x zaagblaadjes en koffer

Art.nr. 5706 701 2

VE/st. 1



DE WÜRTH

M-CUBE® 18 V RANGE

Krachtige accu-technologie - Duurzaam en veilig

Met de krachtige M-Cube-accu's van Würth kunt u zo flexibel mogelijk blijven: eenvoudig de machine vervangen en doorgaan met werken.

- Stevig frame met optimale warmteafvoer beschermt tegen oververhitting en trillingen
- Lange levensduur en optimale prestaties
- Permanente monitoring van de beschikbare accucapaciteit
- Rubberen buitenkant zorgt voor een vaste grip

Boorschroefmachine ABS 18 BASIC

Art.nr. 5701 408 004
VE/st. 1

Boorschroefmachine ABS 18 COMPACT

Art.nr. 5701 800 3
VE/st. 1



M-CUBE®
BATTERY-SYSTEM

**Slagschroefmachine
ASS 18 1/4 Compact**

Art.nr. 5701 415 004
VE/st. 1



**Boorschroefmachine
ABS 18 POWER**

Art.nr. 5701 404 005
VE/st. 1



**Klopboorschroefmachine
ABS 18 POWER COMBI**

Art.nr. 5701 405 005
VE/st. 1



Stofzuiger

Art.nr. 5701 400 000
VE/st. 1



**Stofafzuiging
ASA 18 Compact**

Art.nr. 5701 407 000
VE/st. 1



**Boorhamer
ABH 18 COMPACT**

Art.nr. 5701 432 005
VE/st. 1



**Haakse slijpmachine AWS 18
125P Compact**

Art.nr. 5701 402 005
VE/st. 1



**Kitpistool
AKP 18-600**

Art.nr. 5701 410 004
VE/st. 1



**Snelbouwschroefmachine
ATS 18 AUTOMATIC**

Art.nr. 5701 409 004
VE/st. 1





**Industriële nat- en droogzuiger
ISS 30-L Automatic**

Art.nr. 0701 13 30
VE/st. 1



**Industriële nat- en droogzuiger
ISS 40-M Automatic**

Art.nr. 0701 14 30
VE/st. 1



**Hamerboor met stofafzuiging
SDS-plus**

Art.nr. 0648 40. ...
VE/st. 1



Accu boorhamer H 28-MAS

Art.nr. 5700 80 14

VE/st. 1



Stofafzuiginrichting voor boorhamer H 28-MA(S)

Art.nr. 5700 800 100

VE/st. 1



Stofafzuiging BSA 50 voor boorhamer

Art.nr. 5708 203 100

VE/st. 1



Stofafzuiging, universeel

Art.nr. 0903 990 010

VE/st. 1



Stofafzuiging, universeel

tot Ø 85 mm

Art.nr. 0702 835 090

VE/st. 1



WÜRTH BARCODE ELEKTRISCH GEREEDSCHAP, GEREEDSCHAPSTAS & -KIST



07021870 VE 1
Handcirkelzaag, HKS 86-2
HANDCIRKELZAAGMACHINE - (HKS 86-2)



07025571 VE 1
Boor-/hakhamer BMH 45-XE.
BOOR- HAKHAMER BMH 45-XE



57065401 VE 1
Schrobzaag SBS 1100-E
SCHROBZAAGMACHINE SBS 1100-E



57070030 VE 1
Haakse slijpmachine EWS 10-125 Compact
HAAKSE SLIJPMACHINE EWS 10-125 COMPACT



071593 21 VE 1
Gereedschapskoffer Standaard
GEREEDSCHAPPENKAST, STANDAARD, 540 MM



0962219200 VE 1
Kunststof draagbare gereedschapskist
GEREEDSKOFFR-DRAAGBOX-KST-41,5X26X20,5



0715930222 VE 1
Open gereedschapstas
GEREEDSCHAPSTAS-OPEN-KNSTSTF BODEM



07013440 VE 1
Afkort- en verstekzaagmachine KGS 270-60...
AFKORT- EN VERSTEKZAAGMACH. KGS 270-60...



070244620 VE 1
Tweehands haakse slijper EWS 24-230-S
HAAKSE SLIJPMACHINE EWS 24-230-S



07026951 VE 1
Reciprozaag, SBS 1300-VES
SCHROBZAAGMACHINE SBS 1300-VES



07021290 VE 1
Excentrische schijfschuurmachine ETS 150...
EXCENTRISCHE SCHUURM. ETS 150-E TWIN



07023222 VE 1
Klopboormachine SB 13-XE
KLOPBOORMACHINE SB 13-XE



07025571 VE 1
Boorhamer/beitelhamer BMH 45-XE
BOOR- HAKHAMER BMH 45-XE



0962219002 VE 1
Gereedschapskist van hoogwaardig polypropyleen
GEREEDSCHAPSKIST-510X235X230MM



GEREEDSCHAPSTAS & KOFFERS

Gereedschapskist

Standaard

- Hamerslag blauw
- Holle handvatten
- Kan met hangslot afgesloten worden

Art.nr. 0715 93 21

VE/st. 1

Open gereedschapstas

- Lengte x breedte x hoogte:
440 x 250 x 360 mm
- Materiaal: PES - Polyester
- Kleur: Zwart, Grijs
- Maximaal draagvermogen: 15 kg

Art.nr. 0715 930 222

VE/st. 1

Gereedschapsbak

- 2 vakken van 35 x 10 x 10 cm
- Kunststof met aluminium handgreep

Art.nr. 0962 219 200

VE/st. 1



Gereedschapskist premium

510 x 235 x 230 mm

Art.nr. 0962 190 02

VE/st. 1





Hamertacker ST 11 Ergonomic

Art.nr. 0714 811

VE/st. 1



Hamertacker ST 54

Art.nr. 0714 854

VE/st. 1



Nieten voor hamertacker

Art.nr. 0480 140 0..

VE/st. 1



0480140006	VE 5000	1,25x6		11x6
Nieten voor hamer- en handtacker NIETEN-TBV-HT34-11,0X6MM				
0480140008	VE 5000	1,25x8		11x8
Nieten voor hamer- en handtacker NIETEN-TBV-HT34-11,0X8MM				
0480140010	VE 5000	1,25x10		11x10
Nieten voor hamer- en handtacker NIETEN-TBV-HT34-11,0X10MM				
0480140012	VE 5000	1,25x12		11x12
Nieten voor hamer- en handtacker NIETEN-TBV-HT34-11,0X12MM				
0480140014	VE 5000	1,25x14		11x14
Nieten voor hamer- en handtacker NIETEN-TBV-HT34-11,0X14MM				

GESCHOTEN TECHNIEK GASSCHIETHAMERS

Gasschiethamer WO-1/34 DIGA WOOD

- Houtconstructies
- Nagenoeg terugslagvrij
- Magazijn 44 stripnagels van 34°

Art.nr. 0864 93

VE/st. 1



Gasschiethamer CS-3 power DIGA CS3

- Beton, vol steen en staal
- Nagenoeg terugslagvrij
- Magazijn 40 stripnagels, lengte 15 - 40 mm

Art.nr. 0864 90 3

VE/st. 1



Nagels met gaspatronen DIGA WOOD

3.000 nagels + 3 gaspatronen

Voorbeeld

50 x 2.8 mm Art.nr. 0864 937 350

2.000 nagels + 2 gaspatronen

Voorbeeld

80 x 2.8 mm Art.nr. 0864 937 380



Nagels met gaspatronen DIGA CS3

800 nagels + 1 gaspatroon

Voorbeeld

25 x 2.6 mm Art.nr. 0864 950 025

32 x 3.0 mm Art.nr. 0864 950 232















































DEMONSTRATIE MOGELIJK OP UW BOUWPLAATS

Vraag uw vertegenwoordiger
naar de mogelijkheden



WÜRTH BARCODE SPIJKERS & NAGELS

 047878 104 VE 1 DIN 1151 staal blank DRAADNAGELS ROND PGK BLANK--5KG 2,2x40	
 047878 107 VE 1 DIN 1151 staal blank DRAADNAGELS ROND PGK BLANK-5KG 2,7x55	
 047878 200 VE 1 Draadnagel DRAADNAGELS ROND PGK-A2K-2,4X50-5KG 2,4x50	
 047878 202 VE 1 Draadnagel DRAADNAGELS ROND PGK-A2K-3,0X65-5KG 3x65	
 047878 254 VE 1 Staalnagel DRAADNAGEL ROND VK-A2K-2,0X40-5KG 2x40	
 047878 507 VE 1000 Staalnagels Plat Conisc... STAALNAGELS PCK BUIGZAAM-A2K-3,0X40 3x40	
 047878 550 VE 1000 Schroefnagels SCHROEFNAGELS GLANS VERZINKT PK-3,8X32 3,8x32	
 047883165 VE 1 Duplexnagel BEKISTINGSNAGEL DUBBEL KOP L-65 1 - 5K 3,1x65	
 0478925425 VE 1 Asfaltnagel ASFALTNAGEL-(ZP)-2,5X25MM-2,5KG 2,5x25	
 0681569057 VE 1 Dubbele-kopnagel DUPLEXNAGEL-DUBBELE-KOP-5KG-2,8X57X67 2,8x67	
 047904540 VE 500 Klisjesnagel gehard staal verzinkt KLIJSJESNAGEL-PCK-GEHARD-STAAL-VZ-4,5X40 4,5x40	

 047878 106 VE 1 DIN 1151 staal blank DRAADNAGELS ROND PGK BLANK--5KG 2,4x50	
 047878 108 VE 1 DIN 1151 staal blank DRAADNAGELS ROND PGK BLANK-5KG 3,0x65	
 047878 201 VE 1 Draadnagel DRAADNAGELS ROND PGK-A2K-2,7X55-5KG 2,7x55	
 047878 203 VE 1 Draadnagel DRAADNAGELS ROND PGK-A2K-3,0X80-5KG 3x80	
 047878 504 VE 1000 Staalnagels Plat Conisc... STAALNAGELS PCK BUIGZAAM-A2K-2,5X30 2,5x30	
 047878 508 VE 1000 Staalnagels Plat Conisc... STAALNAGELS PCK BUIGZAAM-A2K-3,0X50 3x50	
 047878 951 VE 1 Schroefnagel RVS A2 SCHROEFNAGELS RVSA2 BOMBE KOP-2,9X45-1F 2,9x45	
 047883480 VE 1 Duplexnagel BEKISTINGSNAGEL DUBBEL KOP L-80 1=5K 3,4x80	
 0681569050 VE 1 Dubbele-kopnagel DUPLEXNAGEL-DUBBELE-KOP-5KG-2,8X50X60 2,8x60	
 0681569064 VE 1 Dubbele-kopnagel DUPLEXNAGEL-DUBBELE-KOP-5KG-3,4X64X74 3,4x74	
 047904550 VE 500 Klisjesnagel gehard staal verzinkt KLIJSJESNAGEL-PCK-GEHARD-STAAL-VZ-4,5X50 4,5x50	

SPIJKERS & NAGELS

Asfaltnagel

Verzinkt

- 2,5 x 25 mm
- Kop Ø 9 mm

Art.nr. 0478 925 425

2,5 kg



Klisjesnagel, draadnagel

Verzinkt

4,5 x 40 mm **Art.nr. 0479 045 40**

4,5 x 50 mm **Art.nr. 0479 045 50**

VE/st. 500



Schroefnagel

Glans verzinkt

- 3,8 x 32 mm
- Kop Ø 8 mm

Art.nr. 0478 78 550

VE/st. 1.000



Duplexnagel

Verzinkt

- Dubbele kop

3,1 x 55 / 65 mm **Art.nr. 0478 831 65**

3,4 x 70 / 80 mm **Art.nr. 0478 834 80**

5 kg



Duplexnagel

Blank

- Dubbele kop

2,8 x 50 / 60 mm **Art.nr. 0681 569 050**

2,8 x 57 / 67 mm **Art.nr. 0681 569 057**

3,4 x 64 / 74 mm **Art.nr. 0681 569 064**

5 kg



Staalnagel

Verzinkt

- Conische kop
- **Buigzaam**

2,5 x 30 mm **Art.nr. 0478 78 504**

3,0 x 40 mm **Art.nr. 0478 78 507**

3,0 x 50 mm **Art.nr. 0478 78 508**

VE/st. 1.000



Draadnagel, spijker

Blank

- Platgeruite kop
- DIN1151

2,2 x 40 mm **Art.nr. 0478 78 104**

2,4 x 50 mm **Art.nr. 0478 78 106**

2,7 x 55 mm **Art.nr. 0478 78 107**

3,0 x 65 mm **Art.nr. 0478 78 108**

5 kg



Draadnagel, spijker

Verzinkt

- Platgeruite kop
- DIN1151

2,4 x 50 mm **Art.nr. 0478 78 200**

2,7 x 55 mm **Art.nr. 0478 78 201**

3,0 x 65 mm **Art.nr. 0478 78 202**

3,0 x 80 mm **Art.nr. 0478 78 203**

5 kg



Draadnagel, spijker

Verzinkt

- Platgeruite dunne kop

2,0 x 40 mm **Art.nr. 0478 78 254**

5 kg



Schroefnagel

RVS A2

- Platbolkop

2,5 x 40 mm **Art.nr. 0478 78 950***

2,9 x 45 mm **Art.nr. 0478 78 951**

2,9 x 50 mm **Art.nr. 0478 78 952***

1 kg

* geen barcodesticker



LANGLOPENDE PROJECTEN?

Vraag uw Würth vertegenwoordiger naar de Würth oplossingen op de bouwplaats om te zorgen dat u door kunt gaan met bouwen



BOUWLOCATIE LOGISTIEK

Overzicht Bauloc service boxen-service containers



Service-box ruwbouw
Mobiël magazijn



Service-box afbouw
Mobiël magazijn



Service-box 10FT
Stationair magazijn



Service-container 20FT
Stationair magazijn



Service-container 40FT
Stationair magazijn



Service-shop
Stationair magazijn

ZESKANTBOUTEN & METAALSCHROEVEN



Zeskantbouten, tapbouten / borstbouten

Blauw verzinkt standaard 8.8 kwaliteit

Bouten ook verkrijgbaar in:
RVS A2, RVS A4, 8.8 thermisch verzinkt en blank



Zeskantbout / tapbout

DIN 933 / ISO 4017
Staal verzinkt 8.8

Art.nr. 0057 (maat)

Voorbeeld
8 x 30 = 0057 8 30
12 x 35 = 0057 12 35



Zeskantbout met borst

DIN 931 / ISO 4014
Staal verzinkt 8.8

Art.nr. 0053 (maat)

Voorbeeld
8 x 80 = 0053 8 80
12 x 70 = 0053 12 70



Metaalschroeven

ISO 1207
DIN 84
Zaagsnede

Art.nr. 0040 ...



ISO 4762
DIN 912
Binnenzeskant

Art.nr. 0084 ...



ISO 14583
ISO 7045
DIN 7985
Bol

Art.nr. 0046 ...



ISO 14581
ISO 10642
DIN 963
Verzonken

Art.nr. 0039 ...



WÜRTH BARCODE

DRAADEINDEN, RINGEN & MOEREN

<p>031710 VE 300 Zeskantmoer MOER-6K-DIN934-I8I-SW17-(A2K)-M10</p>	<p>10</p>	
<p>03176 VE 250 Zeskantmoer MOER-6K-DIN934-I8I-SW10-(A2K)-M6</p>	<p>6</p>	
<p>040710 VE 100 Platte ring voor zeskantbouten en -moere... SLUITRING-DIN125-A-140HV-(A2K)-D10,5</p>	<p>10,5</p>	
<p>04076 VE 500 Platte ring voor zeskantbouten en -moere... SLUITRING-DIN125-A-140HV-(A2K)-D6,4</p>	<p>6,4</p>	
<p>041110 30 VE 100 DIN 522 staal verzinkt CARROSS.ROND.-TOLDIN522-(A2K)10,5X30X1,5</p>	<p>10,5</p>	
<p>04116 20 VE 100 DIN 522 staal verzinkt CARROSS.ROND.-TOLDIN522-(A2K)6,4X20X1,25</p>	<p>6,4</p>	
<p>04118 24 VE 250 DIN 522 staal verzinkt CARROSS.ROND.-TOLDIN522-(A2K)8,4X25X1,25</p>	<p>8,4</p>	
<p>041610 VE 100 Ring SLUITRING-DIN9021-140HV-(A2K)-D10,5</p>	<p>10,5</p>	
<p>041616 VE 100 Ring SLUITRING-DIN9021-140HV-(A2K)-D17,0</p>	<p>17</p>	
<p>095810 VE 10 DIN 976 gegalvaniseerd staal 4.8 DRAAD-EIND-DIN976-4.8-(A2K)-M10X1000</p>	<p>10x1000</p>	
<p>09586 VE 10 DIN 976 gegalvaniseerd staal 4.8 DRAAD-EIND-DIN976-4.8-(A2K)-M6X1000</p>	<p>6x1000</p>	

<p>031712 VE 100 Zeskantmoer MOER-6K-DIN934-I8I-SW19-(A2K)-M12</p>	<p>12</p>	
<p>03178 VE 250 Zeskantmoer MOER-6K-DIN934-I8I-SW13-(A2K)-M8</p>	<p>8</p>	
<p>040712 VE 100 Platte ring voor zeskantbouten en -moere... SLUITRING-DIN125-A-140HV-(A2K)-D13,0</p>	<p>13</p>	
<p>04078 VE 250 Platte ring voor zeskantbouten en -moere... SLUITRING-DIN125-A-140HV-(A2K)-D8,4</p>	<p>8,4</p>	
<p>041112 40 VE 100 DIN 522 staal verzinkt CARROSS.ROND.-TOLDIN522-(A2K)13,0X40X2,0</p>	<p>13</p>	
<p>04116 30 VE 100 DIN 522 staal verzinkt CARROSS.ROND.-TOLDIN522-(A2K)6,4X30X1,25</p>	<p>6,4</p>	
<p>04118 30 VE 100 DIN 522 staal verzinkt CARROSS.ROND.-TOLDIN522-(A2K)-8,4X30X1,5</p>	<p>8,4</p>	
<p>041612 VE 100 Ring SLUITRING-DIN9021-140HV-(A2K)-D13,0</p>	<p>13</p>	
<p>095812 VE 10 DIN 976 gegalvaniseerd staal 4.8 DRAAD-EIND-DIN976-4.8-(A2K)-M12X1000</p>	<p>12x1000</p>	
<p>09588 VE 10 DIN 976 gegalvaniseerd staal 4.8 DRAAD-EIND-DIN976-4.8-(A2K)-M8X1000</p>	<p>8x1000</p>	

DRAADEINDEN, RINGEN & MOEREN



Draadeinden

DIN 975, 1 meter, staal verzinkt 4.8

- 6 mm **Art.nr. 0958 6**
- 8 mm **Art.nr. 0958 8**
- 10 mm **Art.nr. 0958 10**
- 12 mm **Art.nr. 0958 12**

Ook verkrijgbaar in:

- Andere diameters
- Andere draadeindstukken
- 2 en 3 meter
- RVS A2, RVS A4, 8.8 verzinkt, messing, blank en thermisch verzinkt

Moer

DIN 934 / ISO 4032, staal verzinkt 8.8

Art.nr. 0317 (maat)

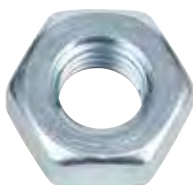

Ook verkrijgbaar in RVS A2, RVS A4, 8.8 verzinkt, messing, blank en thermisch verzinkt

Sluitring

DIN 125, staal verzinkt

Art.nr. 0407 (maat)



Ook verkrijgbaar in RVS A2, RVS A4, messing, blank en thermisch verzinkt

Carrosseriering

DIN 9021, staal verzinkt 8.8

Art.nr. 0411 (maat)

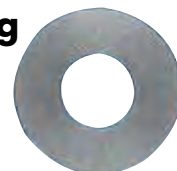

- M6, 20 mm / 30 mm breed
- Art.nr. 0411 6 20 / 0411 6 30**
- M8, 24 mm / 30 mm breed
- Art.nr. 0411 8 24 / 0411 8 30**
- M8, 40 mm breed
- Art.nr. 0411 8 40**
- M10, 30 / 40 mm breed
- Art.nr. 0411 10 30 / 0411 10 40**
- M12, 40 mm breed
- Art.nr. 0411 12 40**

Veerring

Art.nr. 0441



Tandveerring

Art.nr. 0429



Ook in andere maten verkrijgbaar

Borgmoer

Art.nr. 0368



Dopmoer

Art.nr. 0356



Sluitring

DIN 9021, staal galvanisch verzinkt, blauw gepassiveerd (A2K) 140 HV



Art.nr. 0416 (maat)

- M10
- Art.nr. 0416 10**
- M12
- Art.nr. 0416 12**
- M16
- Art.nr. 0416 16**

Verbindingsmoer

Art.nr. 0974



Vierkantmoer

Art.nr. 0337

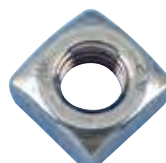

BOORSCHROEVEN PIAS®

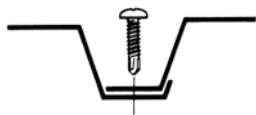

Maten: 3,5 / 3,9 / 4,2 / 4,8

PIASTA® 3,5 / 4,2 / 4,8

PIASTA® is RVS A2 met boorpunt van gehard staal



Boorschroef, PIAS® / PIASTA® = Bi-metaal

Boren, draadsnijden en vastschroeven in 1 beweging

AW® Kruiskop, PH aandrijving, bolkop

DIN7504-N

Staal verzinkt

Art.nr. 0206 (maat)

Voorbeeld 3,9 x 25 = 0206 39 25

RVS A2

Art.nr. 0206 1 (maat)

Voorbeeld 3,9 x 25 = 0206 139 25

PIASTA®, Bi-metaal

Art.nr. 0206 8 (maat)

Voorbeeld 4,2 x 25 = 0206 842 25

AW® 20 BIT

Art.nr. 0614 51 20

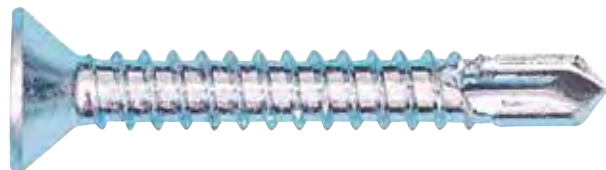

Maten: 2,9 / 3,5 / 3,9 / 4,2 / 4,8 / 5,5 / 6,3



Boorschroef, PIAS®

AW® Kruiskop, PH aandrijving, verzonken kop

DIN7504-P

Staal verzinkt

Art.nr. 0205 7 (maat)

Voorbeeld 3,9 x 25 = 0205 39 25

RVS A2

Art.nr. 0205 1 (maat)

Voorbeeld 3,9 x 25 = 0205 139 25

AW® 20 BIT

Art.nr. 0614 51 20



A2 met boorpunt alleen gebruiken in aluminium en kunststof, niet gehard staal



Maten: 4,2 / 4,8 / 5,5 / 6,3

PIASTA® heeft Ruspert® oppervlaktebehandeling RVS A2 met boorpunt van gehard staal



Boorschroef, PIAS® / PIASTA®

6-kant, zeskantkop met kraag

DIN7504-K

Galvanisch verzinkt

Art.nr. 0214 (maat)

Voorbeeld 3,9 x 25 = 0214 39 25

RVS A2

Art.nr. 0214 1 (maat)

Voorbeeld 4,2 x 25 = 0214 142 25

PIAS® A2 alleen: 4,2 x 25 / 4,8 x 32 / 6,3 x 22

PIASTA®, Bi-metaal

Art.nr. 0214 81 (maat)

Voorbeeld 4,2 x 25 = 0214 814 225

SPAANPLAATSCHROEVEN VZ

WÜPO/WÜRTH POZIDRIV (KRUISKOP)



Spaanplaatschroef voldraad

- Staal
- Blauw gepassiveerd
- Verzonken kop
- PZ kruiskop (blauw verzinkt)

Art.nr. 0198 6 (maat)

Voorbeeld

4 x 40 = 0198 64 40

5 x 80 = 0198 65 80

Maten: 2,4 x 12 t/m 6 x 80

WÜPO FAST



Spaanplaatschroef deeldraad

- Staal
- Blauw gepassiveerd
- Verzonken kop
- PZ kruiskop

Art.nr. 0198 61 (maat)

Voorbeeld

4 x 40 = 0198 614 40

5 x 120 = 0198 615 120

Maten: 3,5 x 25 t/m 6 x 240



Assortiment

2100 delig
3 x 20 t/m 5 x 60

Art.nr. 5964 019 860
VE/st. 1



WÜRTH BARCODE SPAANPLAATSCHROEVEN



<p>019861470 VE 200 4x70 Spaanplaatschroef Wüpfast® 2.0 SHR-PVK-BORST-HO-POZ2-(A2K)-4X70/39</p>	
<p>0198615120 VE 100 5x120 Spaanplaatschroef Wüpfast® 2.0 SHR-PVK-BORST-HO-POZ2-(A2K)-5X120/70</p>	
<p>019861570 VE 200 5x70 Spaanplaatschroef Wüpfast® 2.0 SHR-PVK-BORST-HO-POZ2-(A3K)-5X70/40</p>	
<p>019861590 VE 100 5x90 Spaanplaatschroef Wüpfast® 2.0 SHR-PVK-BORST-HO-POZ2-(A3K)-5X90/54</p>	
<p>0198616120 VE 100 6x120 Spaanplaatschroef Wüpfast® 2.0 SHR-PVK-BORST-HO-POZ3-(A3K) 6X120/70</p>	
<p>0198616160 VE 100 6x160 Spaanplaatschroef Wüpfast® 2.0 SHR-PVK-BORST-HO-POZ3-(A3K)-6X160/70</p>	
<p>019863 20 VE 200 3x20 Spaanplaatschroef WÜPOFAST® 2.0 SHR-PVK-HO-POZ1-(A2K)-3X20</p>	
<p>019863 25 VE 200 3x25 Spaanplaatschroef WÜPOFAST® 2.0 SHR-PVK-HO-POZ1-(A2K)-3X25</p>	
<p>019863516 VE 200 3,5x16 Spaanplaatschroef WÜPOFAST® 2.0 SHR-PVK-HO-POZ2-(A2K)-3,5X16</p>	
<p>019863525 VE 200 3,5x25 Spaanplaatschroef WÜPOFAST® 2.0 SHR-PVK-HO-POZ2-(A2K)-3,5X25</p>	
<p>019863530 VE 200 3,5x30 Spaanplaatschroef WÜPOFAST® 2.0 SHR-PVK-HO-POZ2-(A2K)-3,5X30</p>	

<p>0198615100 VE 100 5x100 Spaanplaatschroef Wüpfast® 2.0 SHR-PVK-BORST-HO-POZ2-(A2K)-5X100/60</p>	
<p>019861560 VE 250 5x60 Spaanplaatschroef Wüpfast® 2.0 SHR-PVK-BORST-HO-POZ2-(A3K)-5X60/35</p>	
<p>019861580 VE 100 5x80 Spaanplaatschroef Wüpfast® 2.0 SHR-PVK-BORST-HO-POZ2-(A3K)-5X80/50</p>	
<p>0198616100 VE 100 6x100 Spaanplaatschroef Wüpfast® 2.0 SHR-PVK-BORST-HO-POZ2-(A2K)-6X100/60</p>	
<p>0198616140 VE 100 6x140 Spaanplaatschroef Wüpfast® 2.0 SHR-PVK-BORST-HO-POZ3-(A3K)-6X140/70</p>	
<p>019863 20 VE 1000 3x20 Spaanplaatschroef WÜPOFAST® 2.0 SHR-PVK-HO-POZ1-(A2K)-3X20</p>	
<p>019863 25 VE 1000 3x25 Spaanplaatschroef WÜPOFAST® 2.0 SHR-PVK-HO-POZ1-(A2K)-3X25</p>	
<p>019863516 VE 1000 3,5x16 Spaanplaatschroef WÜPOFAST® 2.0 SHR-PVK-HO-POZ2-(A2K)-3,5X16</p>	
<p>019863525 VE 1000 3,5x25 Spaanplaatschroef WÜPOFAST® 2.0 SHR-PVK-HO-POZ2-(A2K)-3,5X25</p>	
<p>019863530 VE 1000 3,5x30 Spaanplaatschroef WÜPOFAST® 2.0 SHR-PVK-HO-POZ2-(A2K)-3,5X30</p>	

WÜRTH BARCODE SPAANPLAATSCHROEVEN



<p>019863535 VE 200 3,5x35 Spaanplaatschroef WÜPOFAST® 2.0 SHR-PVK-HO-POZ2-(A2K)-3,5X35</p>	
<p>019863540 VE 200 3,5x40 Spaanplaatschroef WÜPOFAST® 2.0 SHR-PVK-HO-POZ2-(A2K)-3,5X40</p>	
<p>019864 20 VE 200 4x20 Spaanplaatschroef WÜPOFAST® 2.0 SHR-PVK-HO-POZ2-(A2K)-4X20</p>	
<p>019864 25 VE 200 4x25 Spaanplaatschroef WÜPOFAST® 2.0 SHR-PVK-HO-POZ2-(A2K)-4X25</p>	
<p>019864 30 VE 200 4x30 Spaanplaatschroef WÜPOFAST® 2.0 SHR-PVK-HO-POZ2-(A2K)-4X30</p>	
<p>019864 35 VE 200 4x35 Spaanplaatschroef WÜPOFAST® 2.0 SHR-PVK-HO-POZ2-(A2K)-4X35</p>	
<p>019864 40 VE 200 4x40 Spaanplaatschroef WÜPOFAST® 2.0 SHR-PVK-HO-POZ2-(A2K)-4X40</p>	
<p>019864 45 VE 200 4x45 Spaanplaatschroef WÜPOFAST® 2.0 SHR-PVK-HO-POZ2-(A2K)-4X45</p>	
<p>019864 50 VE 200 4x50 Spaanplaatschroef WÜPOFAST® 2.0 SHR-PVK-HO-POZ2-(A2K)-4X50</p>	
<p>019864 55 VE 250 4x55 Spaanplaatschroef WÜPOFAST® 2.0 SHR-PVK-HO-POZ2-(A2K)-4X55</p>	
<p>019865 50 VE 250 5x50 Spaanplaatschroef WÜPOFAST® 2.0 SHR-PVK-HO-POZ2-(A2K)-5X50</p>	

<p>019863535 VE 1000 3,5x35 Spaanplaatschroef WÜPOFAST® 2.0 SHR-PVK-HO-POZ2-(A2K)-3,5X35</p>	
<p>019863540 VE 500 3,5x40 Spaanplaatschroef WÜPOFAST® 2.0 SHR-PVK-HO-POZ2-(A2K)-3,5X40</p>	
<p>019864 20 VE 1000 4x20 Spaanplaatschroef WÜPOFAST® 2.0 SHR-PVK-HO-POZ2-(A2K)-4X20</p>	
<p>019864 25 VE 1000 4x25 Spaanplaatschroef WÜPOFAST® 2.0 SHR-PVK-HO-POZ2-(A2K)-4X25</p>	
<p>019864 30 VE 500 4x30 Spaanplaatschroef WÜPOFAST® 2.0 SHR-PVK-HO-POZ2-(A2K)-4X30</p>	
<p>019864 35 VE 500 4x35 Spaanplaatschroef WÜPOFAST® 2.0 SHR-PVK-HO-POZ2-(A2K)-4X35</p>	
<p>019864 40 VE 500 4x40 Spaanplaatschroef WÜPOFAST® 2.0 SHR-PVK-HO-POZ2-(A2K)-4X40</p>	
<p>019864 45 VE 500 4x45 Spaanplaatschroef WÜPOFAST® 2.0 SHR-PVK-HO-POZ2-(A2K)-4X45</p>	
<p>019864 50 VE 500 4x50 Spaanplaatschroef WÜPOFAST® 2.0 SHR-PVK-HO-POZ2-(A2K)-4X50</p>	
<p>019864 60 VE 250 4x60 Spaanplaatschroef WÜPOFAST® 2.0 SHR-PVK-HO-POZ2-(A2K)-4X60</p>	
<p>019865 60 VE 250 5x60 Spaanplaatschroef WÜPOFAST® 2.0 SHR-PVK-HO-POZ2-(A2K)-5X60</p>	

WÜRTH BARCODE

SPAANPLAAT SCHROEVEN RVS



<p>01823 20 VE 200 WÜPOFAST roestvast staal A2 VD verzonke... SHR-PVK-HO-A2-Z1-3X20</p> <p>3x20</p>	
<p>01823 30 VE 200 WÜPOFAST roestvast staal A2 VD verzonke... SHR-PVK-HO-A2-Z1-3X30</p> <p>3x30</p>	
<p>018235 20 VE 200 WÜPOFAST roestvast staal A2 VD verzonke... SCHROEF-VERZONKENKOPA2-Z2-3,5X20</p> <p>3,5x20</p>	
<p>018235 30 VE 200 WÜPOFAST roestvast staal A2 VD verzonke... SCHROEF-VERZONKENKOPA2-Z2-3,5X30</p> <p>3,5x30</p>	
<p>018235 40 VE 200 WÜPOFAST roestvast staal A2 VD verzonke... SCHROEF-VERZONKENKOPA2-Z2-3,5X40</p> <p>3,5x40</p>	
<p>01824 25 VE 200 WÜPOFAST roestvast staal A2 VD verzonke... SCHROEF-VERZONKENKOPA2-Z2-4X25</p> <p>4x25</p>	
<p>01824 35 VE 200 WÜPOFAST roestvast staal A2 VD verzonke... SCHROEF-VERZONKENKOPA2-Z2-4X35</p> <p>4x35</p>	
<p>01825 50 VE 250 WÜPOFAST roestvast staal A2 VD verzonke... SCHROEF-VERZONKENKOPA2-Z2-5X50</p> <p>5x50</p>	
<p>01825 70 VE 200 WÜPOFAST roestvast staal A2 VD verzonke... SCHROEF-VERZONKENKOPA2-Z2-5X70</p> <p>5x70</p>	
<p>01826 60 VE 200 WÜPOFAST roestvast staal A2 VD verzonke... SCHROEF-VERZONKENKOPA2-Z3-6X60</p> <p>6x60</p>	

<p>01823 25 VE 200 WÜPOFAST roestvast staal A2 VD verzonke... SHR-PVK-HO-A2-Z1-3X25</p> <p>3x25</p>	
<p>018235 16 VE 200 WÜPOFAST roestvast staal A2 VD verzonke... SHR-PVK-HO-A-Z1-3,5X16</p> <p>3,5x16</p>	
<p>018235 25 VE 200 WÜPOFAST roestvast staal A2 VD verzonke... SCHROEF-VERZONKENKOPA2-Z2-3,5X25</p> <p>3,5x25</p>	
<p>018235 35 VE 200 WÜPOFAST roestvast staal A2 VD verzonke... SCHROEF-VERZONKENKOPA2-Z2-3,5X35</p> <p>3,5x35</p>	
<p>01824 20 VE 200 WÜPOFAST roestvast staal A2 VD verzonke... SCHROEF-VERZONKENKOPA2-Z2-4X20</p> <p>4x20</p>	
<p>01824 30 VE 200 WÜPOFAST roestvast staal A2 VD verzonke... SCHROEF-VERZONKENKOPA2-Z2-4X30</p> <p>4x30</p>	
<p>01824 40 VE 200 WÜPOFAST roestvast staal A2 VD verzonke... SCHROEF-VERZONKENKOPA2-Z2-4X40</p> <p>4x40</p>	
<p>01824 50 VE 100 WÜPOFAST roestvast staal A2 VD verzonke... SCHROEF-VERZONKENKOPA2-Z2-4X50</p> <p>4x50</p>	
<p>01825 60 VE 250 WÜPOFAST roestvast staal A2 VD verzonke... SCHROEF-VERZONKENKOPA2-Z2-5X60</p> <p>5x60</p>	
<p>01826 50 VE 100 WÜPOFAST roestvast staal A2 VD verzonke... SCHROEF-VERZONKENKOPA2-Z3-6X50</p> <p>6x50</p>	
<p>01826 80 VE 100 WÜPOFAST roestvast staal A2 VD verzonke... SCHROEF-VERZONKENKOPA2-Z3-6X80</p> <p>6x80</p>	

SPAANPLAATSCHROEVEN RVS

WÜPO / WÜRTH POZIDRIV (KRUISKOP)

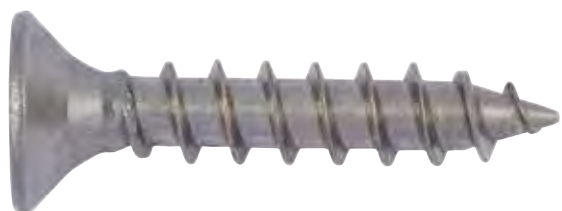

Maten: 3 x 16 t/m 6 x 120

WÜPO



Spaanplaatschroef voldraad

- RVS
- A2
- Verzonken kop
- PZ kruiskop

Art.nr. 0182 (maat)

Voorbeeld

4 x 40 = 0182 4 40

5 x 80 = 0182 5 80



Maten: 3,5 x 40 t/m 6 x 100



Spaanplaatschroef deeldraad

- RVS
- A2
- Verzonken kop
- PZ kruiskop

Art.nr. 0182 81 (maat)

Voorbeeld

4 x 40 = 0182 814 40

5 x 100 = 0182 815 100



WÜRTH BARCODE

SPAANPLAATSCHROEVEN RVS



 018281550 VE 250 WÜPOFAST roestvast staal A2 borst verzo... SCR-CS-WO-A2-Z2-5X50/30	 018281450 VE 500 WÜPOFAST roestvast staal A2 borst verzo... SCR-CS-WO-A2-Z2-4X50/30
 018281570 VE 200 WÜPOFAST roestvast staal A2 borst verzo... SCR-CS-WO-A2-Z2-5X70/40	 0182815100 VE 100 WÜPOFAST roestvast staal A2 borst verzo... SHR-CK-HO-A2-Z2-5X100/60
 0182816100 VE 100 WÜPOFAST roestvast staal A2 borst verzo... SHR-CS-WO-A2-Z3-6X100/60	 018281560 VE 250 WÜPOFAST roestvast staal A2 borst verzo... SCR-CS-WO-A2-Z2-5X60/35
 0182816140 VE 100 WÜPOFAST roestvast staal A2 borst verzo... SCHROEF-VERZONKENKOPA2-Z3-6X140/70	 018281580 VE 100 WÜPOFAST roestvast staal A2 borst verzo... SCHROEF-VERZONKENKOPA2-Z2-5X80/50
 018281680 VE 100 WÜPOFAST roestvast staal A2 borst verzo... SCR-CS-WO-A2-Z3-6X80/50	 0182816120 VE 100 WÜPOFAST roestvast staal A2 borst verzo... SCHROEF-WÜPOFAST-A2-Z3-6X120/70



SPAANPLAATSCHROEVEN TORX



Maten: 2,4 x 12 t/m 6 x 80

Spaanplaatschroef TORX

- Schroef staal verzinkt
- Verzonken kop VD TORX
- Koptype: verzonken kop 90 graden
- Materiaal: staal
- Oppervlakte: verzinkt

Art.nr. 0176 (maat)

Voorbeeld

4 x 40 = 0176 014 40

5 x 80 = 0176 015 80



WÜRTH BARCODE SCHROEVEN TORX







0176013535	VE 1000	3,5x35	Schroef staal verzinkt, verzonken kop bo... SCH-PVK-HOUT-TX20-(A2K)-3,5X35/22SCH-PVK
0176013545	VE 500	3,5x45	Schroef staal verzinkt, verzonken kop bo... SCH-PVK-HOUT-TX10-(A2K)-3,5X45/30
017601430	VE 500	4x30	Schroef staal verzinkt, verzonken kop bo... SCH-PVK-HOUT-TX20-(A3K)-4X30/18
017601450	VE 500	4x50	Schroef staal verzinkt, verzonken kop bo... SCH-PVK-HOUT-TX20-(A2K)-4X50/30
0176014545	VE 500	4,5x45	Schroef staal verzinkt, verzonken kop bo... SCH-PVK-HOUT-TX20-(A3K)-4,5X45/28
0176014560	VE 250	4,5x60	Schroef staal verzinkt, verzonken kop bo... SCH-PVK-HOUT-TX20-(A3K)-4,5X60/35
0176014580	VE 100	4,5x80	Schroef staal verzinkt, verzonken kop bo... SCH-PVK-HOUT-TX20-(A3K)-4,5X80/50
0176015120	VE 100	5x120	Schroef staal verzinkt, verzonken kop bo... SCH-PVK-HOUT-TX20-(A3K)-5X120/70
017601570	VE 200	5x70	Schroef staal verzinkt, verzonken kop bo... SCH-PVK-HOUT-TX20-(A3K)-5X70/40
017601590	VE 100	5x90	Schroef staal verzinkt, verzonken kop bo... SCH-PVK-HOUT-TX20-(A3K)-5X90/54
0176016120	VE 100	6x120	Schroef staal verzinkt, verzonken kop bo... SCH-PVK-HOUT-TX30-(A3K)-6X120/70

0176013540	VE 500	3,5x40	Schroef staal verzinkt, verzonken kop bo... SCH-PVK-HOUT-TX10-(A2K)-3,5X40/24
0176013550	VE 500	3,5x50	Schroef staal verzinkt, verzonken kop bo... SCH-PVK-HOUT-TX10-(A2K)-3,5X50/30
017601440	VE 500	4x40	Schroef staal verzinkt, verzonken kop bo... SCH-PVK-HOUT-TX20-(A3K)-4X40/24
0176014540	VE 500	4,5x40	Schroef staal verzinkt, verzonken kop bo... SCH-PVK-HOUT-TX20-(A3K)-4,5X40/24
0176014550	VE 250	4,5x50	Schroef staal verzinkt, verzonken kop bo... SCH-PVK-HOUT-TX20-(A3K)-4,5X50/30
0176014570	VE 200	4,5x70	Schroef staal verzinkt, verzonken kop bo... SCH-PVK-HOUT-TX20-(A3K)-4,5X70/40
0176015100	VE 100	5x100	Schroef staal verzinkt, verzonken kop bo... SCH-PVK-HOUT-TX20-(A3K)-5X100/60
017601550	VE 250	5x50	Schroef staal verzinkt, verzonken kop bo... SCH-PVK-HOUT-TX20-(A3K)-5X50/30
017601580	VE 100	5x80	Schroef staal verzinkt, verzonken kop bo... SCH-PVK-HOUT-TX20-(A3K)-5X80/50
0176016100	VE 100	6x100	Schroef staal verzinkt, verzonken kop bo... SCH-PVK-HOUT-TX30-(A3K)-6X100/60
0176016140	VE 100	6x140	Schroef staal verzinkt, verzonken kop bo... SCH-PVK-HOUT-TX30-(A3K)-6X140/70

WÜRTH BARCODE SCHROEVEN TORX



	4 0 1 1 2 3 1 2 2 8 7 6 3
0176016160	VE 100 6x160
Schroef staal verzinkt, verzonken kop bo... SCH-PVK-HOUT-TX30-(A3K)-6X160/75	
	4 0 4 5 9 8 9 3 7 1 9 4 5
017601660	VE 200 6x60
Schroef staal verzinkt, verzonken kop bo... SCH-PVK-HOUT-TX30-(A3K)-6X60/35	
	4 0 5 0 6 4 1 4 9 8 2 1
017603525	VE 1000 3,5x25
Schroef staal verzinkt, verzonken kop VD... SHR-SEKPF-HO-TX20-(A2K)-3,5X25/21	
	4 0 4 6 7 7 7 6 7 7 9 8 8
017604 35	VE 500 4x35
Schroef staal verzinkt, verzonken kop VD... SCH-PVK-HOUT-TX20-(A3K)-4X35/30	
	4 0 4 6 7 7 7 6 7 7 9 3 5
017604 45	VE 500 4x45
Schroef staal verzinkt, verzonken kop VD... SCH-PVK-HOUT-TX20-(A3K)-4X45/40	
	4 0 4 6 7 7 7 6 7 7 9 3 5
017605 40	VE 500 5x40
Schroef staal verzinkt, verzonken kop VD... SCH-PVK-HOUT-TX20-(A3K)-5X40/34	

	4 0 1 1 2 3 1 2 2 8 7 8 7
0176016180	VE 100 6x180
Schroef staal verzinkt, verzonken kop bo... SCH-PVK-HOUT-TX30-(A3K)-6X180/70	
	4 0 4 5 9 8 9 3 7 1 9 6 9
017601680	VE 100 6x80
Schroef staal verzinkt, verzonken kop bo... SCH-PVK-HOUT-TX30-(A3K)-6X80/50	
	4 0 5 0 6 4 1 4 9 8 2 1
017603530	VE 1000 3,5x30
Schroef staal verzinkt, verzonken kop VD... SHR-SEKPF-HO-TX20-(A2K)-3,5X30/26	
	4 0 4 6 7 7 7 6 7 7 9 1 1
017604 40	VE 500 4x40
Schroef staal verzinkt, verzonken kop VD... SCH-PVK-HOUT-TX20-(A3K)-4X40/35	
	4 0 4 6 7 7 7 6 7 7 9 3 9
017604 50	VE 500 4x50
Schroef staal verzinkt, verzonken kop VD... SCH-PVK-HOUT-TX20-(A3K)-4X50/45	
	4 0 5 0 6 4 1 4 9 8 2 1
017605 60	VE 250 5x60
Schroef staal verzinkt, verzonken kop VD... SCH-PVK-HOUT-TX20-(A3K)-5X60/54	



SPAANPLAATSCHROEVEN ASSY® 4

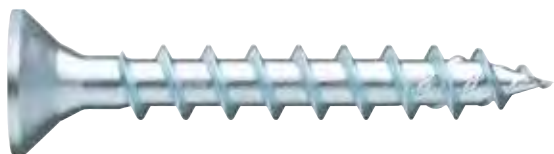

Maten: 3 x 10 t/m 6 x 80

ASSY® 4 CS bevestigingsschroef voldraad

Staal, blauw gepassiveerd, verzonken kop, RW aandrijving

Voordelen RW® aandrijving ASSY® schroeven:

- **1 BIT voor 3,5 x 12 t/m 5 x 120**
- Optimale krachtoverbrenging
- Zeer goede bitpassing (vgl kruiskop)
- Geen come-out (vgl torx)
- Hogere standtijd
- Geen beschadiging oppervlak schroef
- Kleine kans op splijtwerking door tegengestelde schroefgang

Art.nr. 0190 0 (maat 0 x maat)

Voorbeeld

4 x 40 = 0190 040 40

5 x 80 = 0190 050 80

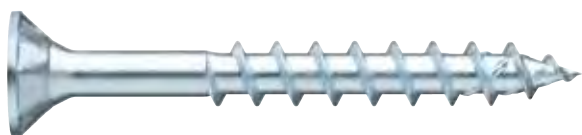

Maten: 3 x 20 t/m 10 x 400

ASSY® 4 CSMP universele schroef deeldraad

Staal, blauw gepassiveerd, verzonken freeskop, RW® aandrijving

- Lichter inschroeven; ook grotere schroeven dankzij geïntegreerde schachtfrees vanaf ø5mm
- Sterkere verankering in hout door asymmetrische high-performance draad
- Snel inbijten vanwege geleidelijke draadstart
- Minder splijten dankzij koepelvormige freeselementen in de punt

Art.nr. 0190 1 (maat 0 x maat)

Voorbeeld

4 x 40 = 0190 140 40

5 x 120 = 0190 150 120

Assortiment



ASSY® 4
spaanplaatschroeven,
voldraad, assortiment
2.102 stuks in systeemkoffer 4.4.1
Art.nr. 5964 019 000
VE/st. 1



ASSY® 4
spaanplaatschroeven,
deeldraad, assortiment
622 stuks in systeemkoffer 4.4.1.
Art.nr. 5964 019 005
VE/st. 1





Art.nr. 0988 995 089
VE/st. 1
Art.nr. 0988 995 078
VE/st. 1

WÜRTH BARCODE

SPAANPLAATSCHROEVEN ASSY® 4





 019003020 VE 1000 **3x20**
 ASSY® 4 CS bevestigingsschroef Staal ve...
 SHR-PLVZK-HO-RW10-(A2K)-3X20/17





 019003030 VE 1000 **3x30**
 ASSY® 4 CS bevestigingsschroef Staal ve...
 SHR-PLVZK-HO-RW10-(A2K)-3X30/25





 019003520 VE 1000 **3,5x20**
 ASSY® 4 CS bevestigingsschroef Staal ve...
 SHR-PLVZK-HO-RW20-(A2K)-3,5X20/16





 019003525 VE 1000 **3,5x25**
 ASSY® 4 CS bevestigingsschroef Staal ve...
 SHR-PLVZK-HO-RW20-(A2K)-3,5X25/21





 019003530 VE 1000 **3,5x30**
 ASSY® 4 CS bevestigingsschroef Staal ve...
 SHR-PLVZK-HO-RW20-(A2K)-3,5X30/25





 019003535 VE 1000 **3,5x35**
 ASSY® 4 CS bevestigingsschroef Staal ve...
 SHR-PLVZK-HO-RW20-(A2K)-3,5X35/30





 019003540 VE 500 **3,5x40**
 ASSY® 4 CS bevestigingsschroef Staal ve...
 SHR-PLVZK-HO-RW20-(A2K)-3,5X40/35





 019004020 VE 1000 **4x20**
 ASSY® 4 CS bevestigingsschroef Staal ve...
 SHR-PLVZK-HO-RW20-(A2K)-4X20/16





 019004025 VE 1000 **4x25**
 ASSY® 4 CS bevestigingsschroef Staal ve...
 SHR-PLVZK-HO-RW20-(A2K)-4X25/21





 019004030 VE 500 **4x30**
 ASSY® 4 CS bevestigingsschroef Staal ve...
 SHR-PLVZK-HO-RW20-(A2K)-4X30/24





 019003025 VE 1000 **3x25**
 ASSY® 4 CS bevestigingsschroef Staal ve...
 SHR-PLVZK-HO-RW10-(A2K)-3X25/22





 019003516 VE 1000 **3,5x16**
 ASSY® 4 CS bevestigingsschroef Staal ve...
 SHR-PLVZK-HO-RW20-(A2K)-3,5X16/12





 019003525 VE 200 **3,5x25**
 ASSY® 4 CS bevestigingsschroef Staal ve...
 SHR-PLVZK-HO-RW20-(A2K)-3,5X25/21





 019003530 VE 200 **3,5x30**
 ASSY® 4 CS bevestigingsschroef Staal ve...
 SHR-PLVZK-HO-RW20-(A2K)-3,5X30/25





 019003535 VE 200 **3,5x35**
 ASSY® 4 CS bevestigingsschroef Staal ve...
 SHR-PLVZK-HO-RW20-(A2K)-3,5X35/30





 019003540 VE 200 **3,5x40**
 ASSY® 4 CS bevestigingsschroef Staal ve...
 SHR-PLVZK-HO-RW20-(A2K)-3,5X40/35





 019004020 VE 200 **4x20**
 ASSY® 4 CS bevestigingsschroef Staal ve...
 SHR-PLVZK-HO-RW20-(A2K)-4X20/16





 019004025 VE 200 **4x25**
 ASSY® 4 CS bevestigingsschroef Staal ve...
 SHR-PLVZK-HO-RW20-(A2K)-4X25/21



 019004030 VE 200 **4x30**
 ASSY® 4 CS bevestigingsschroef Staal ve...
 SHR-PLVZK-HO-RW20-(A2K)-4X30/24



 019004035 VE 200 **4x35**
 ASSY® 4 CS bevestigingsschroef Staal ve...
 SHR-PLVZK-HO-RW20-(A2K)-4X35/29



WÜRTH BARCODE

SPAANPLAATSCHROEVEN ASSY® 4



019004035 VE 200 **4x35**
 ASSY® 4 CS bevestigingsschroef Staal ve...
 SHR-PLVZK-HO-RW20-(A2K)-4X35/29

019004040 VE 200 **4x40**
 ASSY® 4 CS bevestigingsschroef Staal ve...
 SHR-PLVZK-HO-RW20-(A2K)-4X40/34

019004045 VE 200 **4x45**
 ASSY® 4 CS bevestigingsschroef Staal ve...
 SHR-PLVZK-HO-RW20-(A2K)-4X45/39

019004050 VE 200 **4x50**
 ASSY® 4 CS bevestigingsschroef Staal ve...
 SHR-PLVZK-HO-RW20-(A2K)-4X50/44

019005050 VE 250 **5x50**
 ASSY® 4 CSMP universele schroef Staal v...
 SHR-PLVZK-FRH-HO-RW20-(A3K)-5X50/42

019014060 VE 250 **4x60**
 ASSY® 4 CSMP universele schroef Staal v...
 SHR-PLVZK-FRH-HO-RW20-(A2K)-4X60/34

0190150100 VE 100 **5x100**
 ASSY® 4 CSMP universele schroef Staal v...
 SHR-PLVZK-FRH-HO-RW20-(A3K)-5X100/52

019015060 VE 250 **5x60**
 ASSY® 4 CSMP universele schroef Staal v...
 SHR-PLVZK-FRH-HO-RW20-(A3K)-5X60/37

019015080 VE 100 **5x80**
 ASSY® 4 CSMP universele schroef Staal v...
 SHR-PLVZK-FRH-HO-RW20-(A3K)-5X80/42

0190160120 VE 100 **6x120**
 ASSY® 4 CSMP universele schroef Staal v...
 SHR-PLVZK-FRH-HO-RW40-(A3K)-6X120/70

0190160160 VE 100 **6x160**
 ASSY® 4 CSMP universele schroef Staal v...
 SHR-PLVZK-FRH-HO-RW40-(A3K)-6X160/70

019004035 VE 500 **4x35**
 ASSY® 4 CS bevestigingsschroef Staal ve...
 SHR-PLVZK-HO-RW20-(A2K)-4X35/29

019004040 VE 500 **4x40**
 ASSY® 4 CS bevestigingsschroef Staal ve...
 SHR-PLVZK-HO-RW20-(A2K)-4X40/34

019004045 VE 500 **4x45**
 ASSY® 4 CS bevestigingsschroef Staal ve...
 SHR-PLVZK-HO-RW20-(A2K)-4X45/39

019004050 VE 500 **4x50**
 ASSY® 4 CS bevestigingsschroef Staal ve...
 SHR-PLVZK-HO-RW20-(A2K)-4X50/44

019005060 VE 250 **5x60**
 ASSY® 4 CSMP universele schroef Staal v...
 SHR-PLVZK-FRH-HO-RW20-(A3K)-5X60/52

019014070 VE 200 **4x70**
 ASSY® 4 CSMP universele schroef Staal v...
 SHR-PLVZK-FRH-HO-RW20-(A2K)-4X70/34

0190150120 VE 100 **5x120**
 ASSY® 4 CSMP universele schroef Staal v...
 SHR-PLVZK-FRH-HO-RW20-(A3K)-5X120/62

019015070 VE 200 **5x70**
 ASSY® 4 CSMP universele schroef Staal v...
 SHR-PLVZK-FRH-HO-RW20-(A3K)-5X70/42

019015090 VE 100 **5x90**
 ASSY® 4 CSMP universele schroef Staal v...
 SHR-PLVZK-FRH-HO-RW20-(A3K)-5X90/47

0190160140 VE 100 **6x140**
 ASSY® 4 CSMP universele schroef Staal v...
 SHR-PLVZK-FRH-HO-RW40-(A3K)-6X140/70

0190160180 VE 100 **6x180**
 ASSY® 4 CSMP universele schroef Staal v...
 SHR-PLVZK-FRH-HO-RW40-(A3K)-6X180/70

WÜRTH BARCODE

ASSY® 4 CS EN CSMP

<p>0190073016 VE 1000 3x16 ASSY® 4 CS beslagschroef Zink-nikkel zwart v... SCHROEF-ZWART-PLVZK-RW10-(P2R)-3X16/13</p>	
<p>0190073025 VE 1000 3x25 ASSY® 4 CS beslagschroef Zink-nikkel zwart v... SCHROEF-ZWART-PLVZK-RW10-(P2R)-3X25/22</p>	
<p>0190073512 VE 1000 3,5x12 ASSY® 4 CS beslagschroef Zink-nikkel zwart v... SCHROEF-ZWART-PLVZK-RW20-(P2R)-3,5X12/8</p>	
<p>0190073520 VE 1000 3,5x20 ASSY® 4 CS beslagschroef Zink-nikkel zwart v... SCHROEF-ZWART-PLVZK-RW20-(P2R)-3,5X20/16</p>	
<p>0190073530 VE 1000 3,5x30 ASSY® 4 CS beslagschroef Zink-nikkel zwart v... SCHROEF-ZWART-PLVZK-RW20-(P2R)-3,5X30/25</p>	
<p>0190073540 VE 500 3,5x40 ASSY® 4 CS beslagschroef Zink-nikkel zwart v... SCHROEF-ZWART-PLVZK-RW20-(P2R)-3,5X40/35</p>	
<p>0190073550 VE 500 3,5x50 ASSY® 4 CS beslagschroef Zink-nikkel zwart v... SCHROEF-ZWART-PLVZK-RW20-(P2R)-3,5X50/45</p>	
<p>0190074025 VE 1000 4x25 ASSY® 4 CS beslagschroef Zink-nikkel zwart v... SCHROEF-ZWART-PLVZK-RW20-(P2R)-4X25/21</p>	
<p>0190074035 VE 500 4x35 ASSY® 4 CS beslagschroef Zink-nikkel zwart v... SCHROEF-ZWART-PLVZK-RW20-(P2R)-4X35/29</p>	
<p>0190074045 VE 500 4x45 ASSY® 4 CS beslagschroef Zink-nikkel zwart v... SCHROEF-ZWART-PLVZK-RW20-(P2R)-4X45/39</p>	
<p>0190074530 VE 500 4,5x30 ASSY® 4 CS beslagschroef Zink-nikkel zwart v... SCHROEF-ZWART-PLVZK-RW20-(P2R)-4,5X30/26</p>	

<p>0190073020 VE 1000 3x20 ASSY® 4 CS beslagschroef Zink-nikkel zwart v... SCHROEF-ZWART-PLVZK-RW10-(P2R)-3X20/17</p>	
<p>0190073030 VE 1000 3x30 ASSY® 4 CS beslagschroef Zink-nikkel zwart v... SCHROEF-ZWART-PLVZK-RW10-(P2R)-3X30/25</p>	
<p>0190073516 VE 1000 3,5x16 ASSY® 4 CS beslagschroef Zink-nikkel zwart v... SCHROEF-ZWART-PLVZK-RW20-(P2R)-3,5X16/12</p>	
<p>0190073525 VE 1000 3,5x25 ASSY® 4 CS beslagschroef Zink-nikkel zwart v... SCHROEF-ZWART-PLVZK-RW20-(P2R)-3,5X25/21</p>	
<p>0190073535 VE 1000 3,5x35 ASSY® 4 CS beslagschroef Zink-nikkel zwart v... SCHROEF-ZWART-PLVZK-RW20-(P2R)-3,5X35/30</p>	
<p>0190073545 VE 500 3,5x45 ASSY® 4 CS beslagschroef Zink-nikkel zwart v... SCHROEF-ZWART-PLVZK-RW20-(P2R)-3,5X45/41</p>	
<p>0190074020 VE 1000 4x20 ASSY® 4 CS beslagschroef Zink-nikkel zwart v... SCHROEF-ZWART-PLVZK-RW20-(P2R)-4X20/16</p>	
<p>0190074030 VE 500 4x30 ASSY® 4 CS beslagschroef Zink-nikkel zwart v... SCHROEF-ZWART-PLVZK-RW20-(P2R)-4X30/24</p>	
<p>0190074040 VE 500 4x40 ASSY® 4 CS beslagschroef Zink-nikkel zwart v... SCHROEF-ZWART-PLVZK-RW20-(P2R)-4X40/34</p>	
<p>0190074050 VE 500 4x50 ASSY® 4 CS beslagschroef Zink-nikkel zwart v... SCHROEF-ZWART-PLVZK-RW20-(P2R)-4X50/44</p>	
<p>0190074540 VE 500 4,5x40 ASSY® 4 CS beslagschroef Zink-nikkel zwart v... SCHROEF-ZWART-PLVZK-RW20-(P2R)-4,5X40/33</p>	

ASSY® 4 CS BESLAGSCHROEF

Zwarte voldraadschroef met verzonken kop voor het bevestigen van metalen beslag of kastverbinders in hout of houtpanelen.

3x16 t/m 4,5x40

Art.nr. 0190 07. ...

VE/st. 500/1000



ASSY® 4 CSMP ZINI HOUTSCHROEF

Zwarte schroef met universele deeldraad voor snelle, naadloze montage van hout-houtverbindingen (vurenhout) in meubel-, interieur- of houtbouw in droge ruimtes.

4x35 t/m 5x100

Art.nr. 0190 77. ...

VE/st. 100/200/250/500



- 

0190774035 VE 500 **4x35**
ASSY® 4 CSMP ZINi hout Schroef Staal zink-nikkel
SCHROEF-ZWART-PLVZFK-RW20-(P2R)-4X35/21

- 

0190774050 VE 500 **4x50**
ASSY® 4 CSMP ZINi hout Schroef Staal zink-nikkel
SCHROEF-ZWART-PLVZFK-RW20-(P2R)-4X50/33

- 

0190774070 VE 200 **4x70**
ASSY® 4 CSMP ZINi hout Schroef Staal zink-nikkel
SCHROEF-ZWART-PLVZFK-RW20-(P2R)-4X70/34

- 

0190775060 VE 250 **5x60**
ASSY® 4 CSMP ZINi hout Schroef Staal zink-nikkel
SCHROEF-ZWART-PLVZFK-RW20-(P3R)-5X60/37

- 

0190775080 VE 100 **5x80**
ASSY® 4 CSMP ZINi hout Schroef Staal zink-nikkel
SCHROEF-ZWART-PLVZFK-RW20-(P3R)-5X80/42

- 

0190775100 VE 100 **5x100**
ASSY® 4 CSMP ZINi hout Schroef Staal zink-nikkel
SCHROEF-ZWART-PLVZFK-RW20-(P3R)-5X100/52



- 

0190774040 VE 500 **4x40**
ASSY® 4 CSMP ZINi hout Schroef Staal zink-nikkel
SCHROEF-ZWART-PLVZFK-RW20-(P2R)-4X40/24

- 

0190774060 VE 250 **4x60**
ASSY® 4 CSMP ZINi hout Schroef Staal zink-nikkel
SCHROEF-ZWART-PLVZFK-RW20-(P2R)-4X60/34

- 

0190775050 VE 250 **5x50**
ASSY® 4 CSMP ZINi hout Schroef Staal zink-nikkel
SCHROEF-ZWART-PLVZFK-RW20-(P3R)-5X50/30

- 

0190775070 VE 200 **5x70**
ASSY® 4 CSMP ZINi hout Schroef Staal zink-nikkel
SCHROEF-ZWART-PLVZFK-RW20-(P3R)-5X70/42

- 

0190775090 VE 100 **5x90**
ASSY® 4 CSMP ZINi hout Schroef Staal zink-nikkel
SCHROEF-ZWART-PLVZFK-RW20-(P3R)-5X90/47



WÜRTH BARCODE

SPAANPLAATSCHROEVEN RVS ASSY® 4



<p>018723020 VE 500 3x20 ASSY® 4 A2 CS bevestigingsschroef A2 ro.. SHR-PLVZK-HO-A2-RW10-3X20/17</p>	
<p>018723516 VE 200 3,5x16 ASSY® 4 A2 CS bevestigingsschroef A2 ro.. SHR-PLVZK-HO-A2-RW20-3,5X16/12</p>	
<p>018723525 VE 200 3,5x25 ASSY® 4 A2 CS bevestigingsschroef A2 ro.. SHR-PLVZK-HO-A2-RW20-3,5X25/21</p>	
<p>018723535 VE 200 3,5x35 ASSY® 4 A2 CS bevestigingsschroef A2 ro.. SHR-PLVZK-HO-A2-RW20-3,5X35/30</p>	
<p>018724025 VE 500 4x25 ASSY® 4 A2 CS bevestigingsschroef A2 ro.. SHR-PLVZK-HO-A2-RW20-4X25/21</p>	
<p>018724040 VE 200 4x40 ASSY® 4 A2 CS bevestigingsschroef A2 ro.. SHR-PLVZK-HO-A2-RW20-4X40/34</p>	
<p>018724050 VE 500 4x50 ASSY® 4 A2 CS bevestigingsschroef A2 ro.. SHR-PLVZK-HO-A2-RW20-4X50/44</p>	
<p>018725060 VE 250 5x60 ASSY® 4 A2 CS bevestigingsschroef A2 ro.. SHR-PLVZK-HO-A2-RW20-5X60/52</p>	
<p>018744050 VE 500 4x50 ASSY® 4 A2 CS universele schroef A2 roe.. SHR-PLVZK-HO-A2-RW20-4X50/34</p>	
<p>018744070 VE 200 4x70 ASSY® 4 A2 CS universele schroef A2 roe.. SHR-PLVZK-HO-A2-RW20-4X70/39</p>	
<p>018745060 VE 250 5x60 ASSY® 4 A2 CS universele schroef A2 roe.. SHR-PLVZK-HO-A2-RW20-5X60/42</p>	

<p>018723025 VE 500 3x25 ASSY® 4 A2 CS bevestigingsschroef A2 ro.. SHR-PLVZK-HO-A2-RW10-3X25/22</p>	
<p>018723520 VE 200 3,5x20 ASSY® 4 A2 CS bevestigingsschroef A2 ro.. SHR-PLVZK-HO-A2-RW20-3,5X20/16</p>	
<p>018723530 VE 200 3,5x30 ASSY® 4 A2 CS bevestigingsschroef A2 ro.. SHR-PLVZK-HO-A2-RW20-3,5X30/25</p>	
<p>018723540 VE 200 3,5x40 ASSY® 4 A2 CS bevestigingsschroef A2 ro.. SHR-PLVZK-HO-A2-RW20-3,5X40/35</p>	
<p>018724030 VE 200 4x30 ASSY® 4 A2 CS bevestigingsschroef A2 ro.. SHR-PLVZK-HO-A2-RW20-4X30/24</p>	
<p>018724045 VE 500 4x45 ASSY® 4 A2 CS bevestigingsschroef A2 ro.. SHR-PLVZK-HO-A2-RW20-4X45/39</p>	
<p>018725050 VE 250 5x50 ASSY® 4 A2 CS bevestigingsschroef A2 ro.. SHR-PLVZK-HO-A2-RW20-5X50/42</p>	
<p>018744040 VE 500 4x40 ASSY® 4 A2 CS universele schroef A2 roe.. SHR-PLVZK-HO-A2-RW20-4X40/24</p>	
<p>018744060 VE 250 4x60 ASSY® 4 A2 CS universele schroef A2 roe.. SHR-PLVZK-HO-A2-RW20-4X60/39</p>	
<p>0187450100 VE 100 5x100 ASSY® 4 A2 CS universele schroef A2 roe.. SHR-PLVZK-HO-A2-RW20-5X100/52</p>	

SPAANPLAATSCHROEVEN RVS ASSY® 4

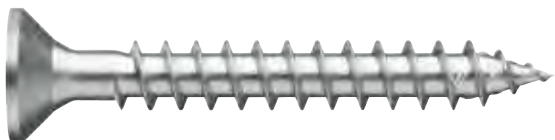

Maten: 3 x 16 t/m 6 x 80



ASSY® 4 A2 CS bevestigingsschroef voldraad

- RVS A2
- Verzonken kop
- RW® aandrijving

Art.nr. 0187 2 (Ø maat) **0** (maat lengte)

Voorbeeld

3 x 20 = 0187 230 20

4 x 40 = 0187 240 40

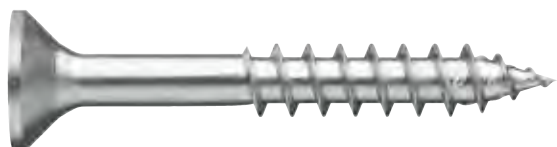

Maten: 3,5 x 40 t/m 6 x 200

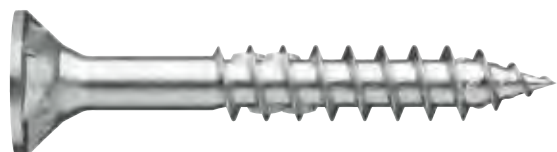

Maten: 8 x 80 t/m 8 x 300



ASSY® 4 A2 CS universele schroef deeldraad

- RVS A2
- Verzonken kop
- RW® aandrijving

Art.nr. 0187 4 (Ø maat) **0** (maat lengte)

Voorbeeld

4 x 40 = 0187 440 40

5 x 100 = 0187 450 100



WÜRTH BARCODE

HARDHOUTSCHROEVEN RVS ASSY® 4

<p>0159753020 VE 200 3x20 ASSY 4 A2 CS hardhout rvs A2 VD vzk kop ... SHR-PLVZK-HARDH-A2-RW10-3X20/17</p>	<p>0159753025 VE 200 3x25 ASSY 4 A2 CS hardhout rvs A2 VD vzk kop ... SHR-PLVZK-HARDH-A2-RW10-3X25/22</p>
<p>0159753030 VE 200 3x30 ASSY 4 A2 CS hardhout rvs A2 VD vzk kop ... SHR-PLVZK-HARDH-A2-RW10-3X30/25</p>	<p>0159753040 VE 200 3x40 ASSY 4 A2 CS hardhout rvs A2 VD vzk kop ... SHR-PLVZK-HARDH-A2-RW10-3X40/35</p>
<p>0159753525 VE 200 3,5x25 ASSY 4 A2 CS hardhout rvs A2 VD vzk kop ... SHR-PLVZK-HARDH-A2-RW20-3,5X25/22</p>	<p>0159753530 VE 200 3,5x30 ASSY 4 A2 CS hardhout rvs A2 VD vzk kop ... SHR-PLVZK-HARDH-A2-RW20-3,5X30/25</p>
<p>0159753535 VE 200 3,5x35 ASSY 4 A2 CS hardhout rvs A2 VD vzk kop ... SHR-PLVZK-HARDH-A2-RW20-3,5X35/30</p>	<p>0159753540 VE 200 3,5x40 ASSY 4 A2 CS hardhout rvs A2 VD vzk kop ... SHR-PLVZK-HARDH-A2-RW20-3,5X40/35</p>
<p>0159754025 VE 200 4x25 ASSY 4 A2 CS hardhout rvs A2 VD vzk kop ... SHR-PLVZK-HARDH-A2-RW20-4X25/21</p>	<p>0159754030 VE 200 4x30 ASSY 4 A2 CS hardhout rvs A2 VD vzk kop ... SHR-PLVZK-HARDH-A2-RW20-4X30/24</p>
<p>0159754035 VE 200 4x35 ASSY 4 A2 CS hardhout rvs A2 VD vzk kop ... SHR-PLVZK-HARDH-A2-RW20-4X35/29</p>	<p>0159754040 VE 200 4x40 ASSY 4 A2 CS hardhout rvs A2 VD vzk kop ... SHR-PLVZK-HARDH-A2-RW20-4X40/34</p>
<p>0159754045 VE 200 4x45 ASSY 4 A2 CS hardhout rvs A2 VD vzk kop ... SHR-PLVZK-HARDH-A2-RW20-4X45/39</p>	<p>0159754050 VE 200 4x50 ASSY 4 A2 CS hardhout rvs A2 VD vzk kop ... SHR-PLVZK-HARDH-A2-RW20-4X50/44</p>
<p>0159754540 VE 200 4,5x40 ASSY 4 A2 CS hardhout rvs A2 VD vzk kop ... SHR-PLVZK-HARDH-A2-RW20-4,5X40/33</p>	<p>0159755040 VE 100 5x40 ASSY 4 A2 CS hardhout rvs A2 VD vzk kop ... SHR-PLVZK-HARDH-A2-RW25-5X40/32</p>
<p>0159755050 VE 100 5x50 ASSY 4 A2 CS hardhout rvs A2 VD vzk kop ... SHR-PLVZK-HARDH-A2-RW25-5X50/42</p>	<p>0159823030 VE 200 3x30 ASSY® 4 A2 CSMR hardhout A2 roestvast s SHR-PLVZK-FRSK-HARTH-A2-RW10-3X30/25</p>
<p>0159823035 VE 200 3x35 ASSY® 4 A2 CSMR hardhout A2 roestvast s SHR-PLVZK-FRSK-HARTH-A2-RW10-3X35/30</p>	<p>0159823040 VE 200 3x40 ASSY® 4 A2 CSMR hardhout A2 roestvast s SHR-PLVZK-FRSK-HARTH-A2-RW10-3X40/35</p>
<p>0159823520 VE 200 3,5x20 ASSY® 4 A2 CSMR hardhout A2 roestvast s SHR-PLVZK-FRSK-HARTH-A2-RW20-3,5X20/16</p>	<p>0159823535 VE 200 3,5x35 ASSY® 4 A2 CSMR hardhout A2 roestvast s SHR-PLVZK-FRSK-HARTH-A2-RW20-3,5X35/30</p>
<p>0159823540 VE 200 3,5x40 ASSY® 4 A2 CSMR hardhout A2 roestvast s SHR-PLVZK-FRSK-HARTH-A2-RW20-3,5X40/35</p>	<p>0159824035 VE 200 4x35 ASSY® 4 A2 CSMR hardhout A2 roestvast s SHR-PLVZK-FRSK-HARTH-A2-RW20-4X35/29</p>
<p>0159824040 VE 200 4x40 ASSY® 4 A2 CSMR hardhout A2 roestvast s SHR-PLVZK-FRSK-HARTH-A2-RW20-4X40/34</p>	<p>0159824045 VE 200 4x45 ASSY® 4 A2 CSMR hardhout A2 roestvast s SHR-PLVZK-FRSK-HARTH-A2-RW20-4X45/39</p>

HARDHOUTSCHROEVEN RVS ASSY® 4



Maten: 3 x 20 t/m 5 x 100



ASSY® 4 A2 CS hardhout

- RVS A2
- Platverzonken kop
- RW® aandrijving
- Voorboren meestal niet nodig
- Dikke schacht

Art.nr. 0159 75 (maat)

Let op! Vanaf lengte 60 mm met borst

Art.nr. 0159 76 (maat)

Voorbeeld

4 x 40 = 0159 754 040

5 x 80 = 0159 765 080



Maten: 3 x 20 t/m 5 x 100



ASSY® 4 A2 CSMR hardhout

- RVS A2
- Freeskop
- Verzonken kop
- RW® aandrijving
- Voorboren meestal niet nodig
- Dikke schacht

Art.nr. 0159 82 (maat)

Let op! Vanaf lengte 60 mm met borst

Art.nr. 0159 83 (maat)

Voorbeeld

4 x 40 = 0159 824 040

5 x 80 = 0159 835 080



Brochure beschikbaar

www.wurth.nl

Service → Download Center → ASSY®4 - De verbeterde ASSY schroef

HOUTCONSTRUCTIESCHROEVEN ASSY® 4



Maten: 5 x 30 t/m 12 x 520

ASSY® berekeningssoftware

Op onze ASSY® website vindt u alle belangrijke informatie rondom onze high-performance schroef:

- Ontwerp software voor het berekenen van de benodigde schroeven
- Alle goedkeuringen van de schroeven
- Referentie projecten



ASSY® 4 WH Tellerkopschroef

Trappenbouw, elementbouw, prefab woningbouw, dakconstructies, balkenbevestiging

- Verzinkt
- Blauw gepassiveerd (A3K)
- **Grote flenskop** (opgeperste ring)
- Deeldraad
- Voor vastzetten houten onderdelen met grotere druk
- De grote kop voorkomt verzinken in hout

Art.nr. 0177 3 (maat)

Voorbeeld

6 x 120 = 0177 360 120

8 x 160 = 0177 380 160

RVS: Art.nr. 0181 81 (maat)

Voorbeeld

8 x 400 = 0181 818 40

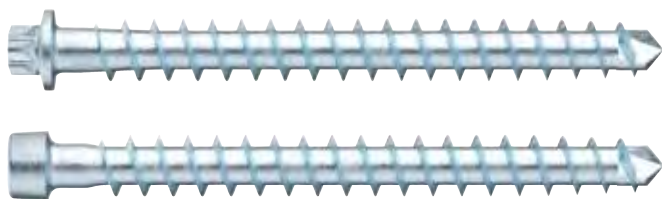

Maten: t/m 14x1500

ASSY® PLUS VG 4 CH constructieschroef voldraad

- Verzinkt
- Blauw gepassiveerd (A3K)
- **Met boorpunt**
- Verzonken kop en cilinderkop
- RW® aandrijving
- Buiten - torx kop

Cilinderkop

Art.nr. 0150 0 (maat)

Voorbeeld

10 x 140 = 0150 010 140



ASSY® 4 COMBI houtbouwschroef deeldraad

Speciale schroef voor zwaarder timmerwerk en hout- en bouwconstructies



- Verzinkt
- Blauw gepassiveerd
- 6 kantkop
- Geïntegreerde RW-aandrijving
- Grote krachtoverbrenging
- Asymetrische draad
- Schachtfrees

Art.nr. 0158 7 (maat)

Voorbeeld

8 x 160 = 0158 780 160

HOUTDRAADBOUTEN & SLOTBOUTEN



Maten:

5 x 30 t/m 16 x 400

Meest verkocht

6 x 60 / 6 x 80 / 6 x 100

8 x 60 / 8 x 80 / 8 x 100 / 8 x 120

Ø 6 mm = sleutelwijdte 10

Ø 8 mm = sleutelwijdte 13

Ø 10 mm = sleutelwijdte 17

Houtdraadbout

- Zeskantkop
- 4.6
- Stevige houtverbindingen

Staal, verzinkt blauw

Art.nr. 0192 (maat)

RVS A2

Art.nr. 0193 (maat)

Ook in thermisch verzinkt verkrijgbaar

Voorbeeld

6 x 80 = 0192 6 80

8 x 60 = 0192 8 60



Afdekkappen

Art.nr. 0590

Slotbouten

- Vierkantnok

Staal, 4.8 verzinkt blauw

Art.nr. 0223 (maat)

RVS A2

Art.nr. 0226 (maat)

Ook in RVS A4, thermisch verzinkt en staal verzinkt 8.8 verkrijgbaar

Voorbeeld

6 x 80 = 0226 6 80

8 x 60 = 0226 8 60



DIN 603

Maten:























5 x 16 t/m 16 x 400

Meest verkocht

6 x 60 / 6 x 80 / 6 x 100

8 x 60 / 8 x 80 / 8 x 100 / 8 x 120 / 8 x 140

WÜRTH BARCODE HOUTDRAADBOUTEN

 4 0 1 1 2 3 1 2 4 6 4 0 8	6x100 01926 100 VE 100 DIN 571, galvanisch verzinkt staal HOUTDRAADBOUT-DIN571-SW10-(A2K)-6X100	
 4 0 1 1 2 3 1 2 4 6 8 1 1	6x80 01926 80 VE 100 DIN 571, galvanisch verzinkt staal HOUTDRAADBOUT-DIN571-SW10-(A2K)-6X80	
 4 0 1 1 2 3 1 2 4 7 1 8 4	8x120 01928 120 VE 50 DIN 571, galvanisch verzinkt staal HOUTDRAADBOUT-DIN571-SW13-(A2K)-8X120	
 4 0 1 1 2 3 1 2 4 7 5 2 8	8x50 01928 50 VE 200 DIN 571, galvanisch verzinkt staal HOUTDRAADBOUT-DIN571-SW13-(A2K)-8X50	
 4 0 1 1 2 3 1 2 4 7 6 3 5	8x80 01928 80 VE 50 DIN 571, galvanisch verzinkt staal HOUTDRAADBOUT-DIN571-SW13-(A2K)-8X80	
 4 0 4 9 5 5 7 3 1 8 0 7 3	6x120 01936 120 VE 100 DIN 571 blank A2 roestvast staal HOUTDRAADBOUT-DIN571-A2-SW10-6X120	 
 4 0 4 5 9 8 9 2 0 7 7 0 1	6x80 01936 80 VE 100 DIN 571 blank A2 roestvast staal HOUTDRAADBOUT-DIN571-A2-SW10-6X80	 
 4 0 4 8 5 3 9 4 9 3 5 4 8	8x120 01938 120 VE 50 DIN 571 blank A2 roestvast staal HOUTDRAADBOUT-DIN571-A2-SW13-8X120	 
 4 0 1 1 2 3 1 2 4 8 0 6 8	8x60 01938 60 VE 100 DIN 571 blank A2 roestvast staal HOUTDRAADBOUT-DIN571-A2-SW13-8X60	 

 4 0 1 1 2 3 1 2 4 6 7 2 9	6x60 01926 60 VE 100 DIN 571, galvanisch verzinkt staal HOUTDRAADBOUT-DIN571-SW10-(A2K)-6X60	
 4 0 1 1 2 3 1 2 4 7 1 2 2	8x100 01928 100 VE 50 DIN 571, galvanisch verzinkt staal HOUTDRAADBOUT-DIN571-SW13-(A2K)-8X100	
 4 0 1 1 2 3 1 2 4 7 2 4 5	8x140 01928 140 VE 50 DIN 571, galvanisch verzinkt staal HOUTDRAADBOUT-DIN571-SW13-(A2K)-8X140	
 4 0 1 1 2 3 1 2 4 7 5 8 0	8x60 01928 60 VE 200 DIN 571, galvanisch verzinkt staal HOUTDRAADBOUT-DIN571-SW13-(A2K)-8X60	
 4 0 4 8 5 3 9 3 5 0 0	6x100 01936 100 VE 100 DIN 571 blank A2 roestvast staal HOUTDRAADBOUT-DIN571-A2-SW10-6X100	 
 4 0 1 1 2 3 1 2 4 7 8 7 0	6x60 01936 60 VE 100 DIN 571 blank A2 roestvast staal HOUTDRAADBOUT-DIN571-A2-SW10-6X60	 
 4 0 1 1 2 3 1 2 4 7 9 7 9	8x100 01938 100 VE 50 DIN 571 blank A2 roestvast staal HOUTDRAADBOUT-DIN571-A2-SW13-8X100	 
 4 0 3 8 8 9 8 6 8 0 3 6	8x140 01938 140 VE 100 DIN 571 blank A2 roestvast staal HOUTDRAADBOUT-DIN571-A2-SW13-8X140	 
 4 0 1 1 2 3 1 2 4 8 1 0 5	8x80 01938 80 VE 100 DIN 571 blank A2 roestvast staal HOUTDRAADBOUT-DIN571-A2-SW13-8X80	 

WÜRTH BARCODE SLOTBOUTEN



02236 100 VE 100
DIN 603 staal 4.8 verzinkt met moer
SLOTBOUT-MR-DIN603-4.8-(A2K)-M6X100



02236 60 VE 200
DIN 603 staal 4.8 verzinkt met moer
SLOTBOUT-MR-DIN603-4.8-(A2K)-M6X60



02238 100 VE 100
DIN 603 staal 4.8 verzinkt met moer
SLOTBOUT-MR-DIN603-4.8-(A2K)-M8X100



02238 60 VE 200
DIN 603 staal 4.8 verzinkt met moer
SLOTBOUT-MR-DIN603-4.8-(A2K)-M8X60



02266 100 VE 100
Platkopbout met vierkantnok
SLOTBOUT-DIN603-A2-M6X100



02266 80 VE 200
Platkopbout met vierkantnok
SLOTBOUT-DIN603-A2-M6X80



02268 120 VE 100
Platkopbout met vierkantnok
SLOTBOUT-DIN603-A2-M8X120



02268 60 VE 100
Platkopbout met vierkantnok
SLOTBOUT-DIN603-A2-M8X60



02236 50 VE 200
DIN 603 staal 4.8 verzinkt met moer
SLOTBOUT-MR-DIN603-4.8-(A2K)-M6X50



02236 80 VE 100
DIN 603 staal 4.8 verzinkt met moer
SLOTBOUT-MR-DIN603-4.8-(A2K)-M6X80



02238 120 VE 100
DIN 603 staal 4.8 verzinkt met moer
SLOTBOUT-MR-DIN603-4.8-(A2K)-M8X120



02238 80 VE 100
DIN 603 staal 4.8 verzinkt met moer
SLOTBOUT-MR-DIN603-4.8-(A2K)-M8X80



02266 60 VE 200
Platkopbout met vierkantnok
SLOTBOUT-DIN603-A2-M6X60



02268 100 VE 100
Platkopbout met vierkantnok
SLOTBOUT-DIN603-A2-M8X100



02268 140 VE 50
Platkopbout met vierkantnok
SLOTBOUT-DIN603-A2-M8X140



02268 80 VE 100
Platkopbout met vierkantnok
SLOTBOUT-DIN603-A2-M8X80



WÜRTH BARCODE SNELBOUWSCHROEVEN

<p>017933925 VE 1000 Staal, gefosfateerd, dubbel schroefdr. H... SNELBOUWSCHR OP BAND-PH2-MG-3,9X25</p>	<p>3,9x25</p>
<p>017933945 VE 1000 Staal, gefosfateerd, dubbel schroefdr. H... SNELBOUWSCHR OP BAND-PH2-MG-3,9X45</p>	<p>3,9x45</p>
<p>017983935 VE 1000 Beschikbaar schroeven op strip, grove dr... SHR-SNELB-PH2-MG/WUERTH-3,9X35</p>	<p>3,9x35</p> <p>GROVE DRAAD</p>
<p>018903525 VE 200 Staal, gefosfateerd, dubbel schroefdraad... SHR-SNELB-DBS-PH2-(PHR)-3,5X25/18</p>	<p>3,5x25</p>
<p>018903545 VE 200 Staal, gefosfateerd, dubbel schroefdraad... SHR-SNELB-DBS-PH2-(PHR)-3,5X45/38</p>	<p>3,5x45</p>
<p>018903925 VE 1000 Staal, gefosfateerd, dubbel schroefdraad... SNELBOUWSCHROEF-DBS-PH2-(PHR)-3,9X25/18</p>	<p>3,9x25</p>
<p>018903945 VE 1000 Staal, gefosfateerd, dubbel schroefdraad... SNELBOUWSCHROEF-DBS-PH2-(PHR)-3,9X45/31</p>	<p>3,9x45</p>
<p>018935 35 VE 1000 Gefosfateerd staal H SNELBOUWSCHROEF-BP-PH2-(PHR)-3,5X35/25</p>	<p>3,5x35</p> <p>BOORPUNT</p>
<p>018939 25 VE 1000 Staal, gefosfateerd, grove draad H SNELBOUWSCHROEF-GROF-PH2-(PHR)-3,9X25/1</p>	<p>3,9x25</p>
<p>018939 35 VE 1000 Staal, gefosfateerd, grove draad H SNELBOUWSCHROEF-GROF-PH2-(PHR)-3,9X35/2</p>	<p>3,9x35</p>
<p>018939 45 VE 1000 Staal, gefosfateerd, grove draad H SNELBOUWSCHROEF-GROF-PH2-(PHR)-3,9X45/3</p>	<p>3,9x45</p>

<p>017933935 VE 1000 Staal, gefosfateerd, dubbel schroefdr. H... SNELBOUWSCHROEF-PH2-MG/WUERTH-3,9X35</p>	<p>3,9x35</p>
<p>017983925 VE 1000 Beschikbaar schroeven op strip, grove dr... SHR-SNELB-PH2-MG/WUERTH-3,9X25</p>	<p>3,9x25</p> <p>GROVE DRAAD</p>
<p>017983945 VE 1000 Beschikbaar schroeven op strip, grove dr... SHR-SNELB-PH2-MG/WUERTH-3,9X45</p>	<p>3,9x45</p> <p>GROVE DRAAD</p>
<p>018903535 VE 200 Staal, gefosfateerd, dubbel schroefdraad... SNELBOUWSCHROEF-DBS-PH2-(PHR)-3,5X35/28</p>	<p>3,5x35</p>
<p>018903919 VE 1000 Staal, gefosfateerd, dubbel schroefdraad... SNELBOUWSCHROEF-DBS-PH2-(PHR)-3,9X19/12</p>	<p>3,9x19</p>
<p>018903935 VE 1000 Staal, gefosfateerd, dubbel schroefdraad... SNELBOUWSCHROEF-DBS-PH2-(PHR)-3,9X35/28</p>	<p>3,9x35</p>
<p>018935 25 VE 1000 Gefosfateerd staal H SNELBOUWSCHROEF-BP-PH2-(PHR)-3,5X25/20</p>	<p>3,5x25</p> <p>BOORPUNT</p>
<p>018935 45 VE 1000 Gefosfateerd staal H SNELBOUWSCHROEF-BP-PH2-(PHR)-3,5X45/30</p>	<p>3,5x45</p> <p>BOORPUNT</p>
<p>018939 30 VE 1000 Staal, gefosfateerd, grove draad H SNELBOUWSCHROEF-GROF-PH2-(PHR)-3,9X30/2</p>	<p>3,9x30</p>
<p>018939 40 VE 1000 Staal, gefosfateerd, grove draad H SHR-SNELB-GROF-PH2-(PHR)-3,9X40/28</p>	<p>3,9x40</p>
<p>018939 55 VE 1000 Staal, gefosfateerd, grove draad H SNELBOUWSCHROEF-GROF-PH2-(PHR)-3,9X55/3</p>	<p>3,9x55</p>

SNELBOUWSCHROEVEN



PH2

Snelbouwschroef

- Staal gefosfateerd
- Dubbele schroefdraad met zeer scherpe punt
- Trompetkop
- PH2 kruiskop
- Gipsplaten of Hout of metaal 1 mm

Art.nr. 0189 (maat)

Op band

Art.nr. 0179 3 (maat)

3,9 x 25

3,9 x 35

3,9 x 45



Maten:

3,5 x 25 / 3,5 x 35 / 3,5 x 45

3,9 x 19 / 3,9 x 25 / 3,9 x 35 / 3,9 x 45 / 3,9 x 55



Snelbouwschroef met boorpunt

- Staal
- Zwart gefosfateerd
- Schroefdraad met Pias® boorpunt
- Trompetkop
- PH2 kruiskop
- **Gipsplaten op metaal** profiel

Art.nr. 0189 (maat)



Maten:

3,5 x 25 / 3,5 x 35 / 3,5 x 45

Snelbouwschroef grove draad

- Staal gefosfateerd
- Grove schroefdraad
- Scherpe punt
- Trompetkop
- PH2 kruiskop
- **Gipsplaten op hout**

Art.nr. 0189 (maat)

Op band

Art.nr. 0179 8 (maat)

3,9 x 25

3,9 x 35

3,9 x 45



Maten:

3,9 x 25 / 3,9 x 30 / 3,9 x 35 / 3,9 x 40 / 3,9 x 45



AFSTANDSMONTAGESCHROEVEN



Maten:
6 x 50 t/m 6 x 160

Meest gebruikt
100 / 120

Bijbehorend bitje
Art.nr. 0614 70 40



JAMO 4 CS hout/beton

Regelbare afstandsmontageschroef Ø 6 mm

- Gehard staal
- Verzinkt
- Blauw gepassiveerd
- Houten constructies op ondergrond van steen/beton
- RW® aandrijving

Art.nr. 0234 564 (lengtemaat schroef)

Voorbeeld

6 x 100 = 0234 564 100

6 x 120 = 0234 564 120

Bij deze doos schroeven zit 1 bitje

Hout/hout:

0234 466 (lengte)



Maten:
7,5 x 72 t/m 7,5 x 302

Meest gebruikt
82 / 92 / 152

Bijbehorend bitje
Art.nr. 0614 513 0



Afstandsmontageschroef

AMOIII® grote kop, type 2 (AW®)

Kopdiameter Ø 8 mm, schroefdiameter Ø 7,5 mm

- Gehard staal
- Verzinkt
- Blauw gepassiveerd
- Houten, metalen en kunststof kozijnen in beton
- Kozijnen koppelen

Art.nr. 0234 830 (lengtemaat schroef)

Voorbeeld

8 x 102 = 0234 830 102

Bij deze doos schroeven zit 1 bitje

KUNSTSTOF CONSTRUCTIEPLUGGEN



Kunststof constructieplug W-UR verzonken kop met AW® aandrijving

Voor beton, volle en holle stenen en gasbeton
(AW30 BIT, art.nr. 0614 51 30)

- Staal verzinkt
- Bevestiging niet dragende systemen

D	8 x 60	Art.nr. 5912 808 402
D	8 x 80	Art.nr. 5912 808 403
D	8 x 100	Art.nr. 5912 808 404



Constructieplug SHARK UR 10

D	10 x 80	Art.nr. 5912 810 401
D	10 x 100	Art.nr. 5912 810 402

(AW40 BIT, art.nr. 0614 51 40)



Kunststof constructieplug W-UR F zeskantkop met aangepaste ring met AW® aandrijving

Voor beton, volle en holle stenen en gasbeton
(AW25 BIT, art.nr. 0614 51 25)

- Staal verzinkt
- Bevestiging niet dragende systemen

D	8 x 60	Art.nr. 5912 808 602
D	8 x 80	Art.nr. 5912 808 603
D	8 x 100	Art.nr. 5912 808 604



Constructieplug SHARK UR F 10

D	10 x 80	Art.nr. 5912 810 601
D	10 x 100	Art.nr. 5912 810 602

(AW40 BIT, art.nr. 0614 51 40)

Montagevoorschrift I

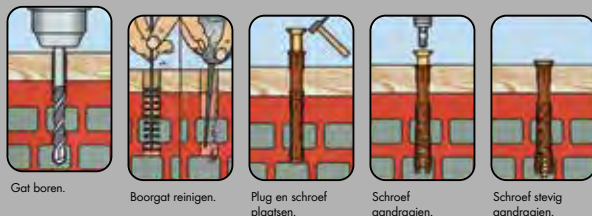

Gat boren.

Boorgat reinigen.

Plug en schroef plaatsen.

Schroef aandraaien.

Schroef stevig aandraaien.

Montagevoorschrift II

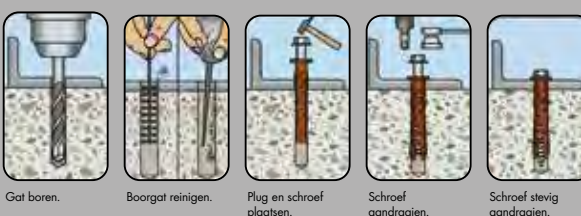

Gat boren.









Boorgat reinigen.

Plug en schroef plaatsen.

Schroef aandraaien.

Schroef stevig aandraaien.

WÜRTH BARCODE SLAGPLUG / NAGELPLUG

 590630530 VE 200 Nagelplug SHARK®Hammer TYPE FK ANK-SLAG-(SHARK HAMER)-FK-5-5X30	
 590630550 VE 200 Nagelplug SHARK®Hammer TYPE FK ANK-SLAG-(SHARK HAMER)-FK-25-5X50	
 590630640 VE 200 Nagelplug SHARK®Hammer TYPE FK ANK-SLAG-(SHARK HAMER)-FK-10-6X40	
 590630660 VE 200 Nagelplug SHARK®Hammer TYPE FK ANK-SLAG-(SHARK HAMER)-FK-30-6X60	
 590630845 VE 100 Nagelplug SHARK®Hammer TYPE FK ANK-SLAG-(SHARK HAMER)-FK-5-8X45	
 590631660 VE 200 Nagelplug SHARK® Hammer TYPE SK ANK-SLAG-(SHARK HAMER)-SK-30-6X60	
 5906318100 VE 100 Nagelplug SHARK® Hammer TYPE SK ANK-SLAG-(SHARK HAMER)-SK-60-8X100	
 5906318135 VE 100 Nagelplug SHARK® Hammer TYPE SK ANK-SLAG-(SHARK HAMER)-SK-95-8X135	
 590631860 VE 100 Nagelplug SHARK® Hammer TYPE SK ANK-SLAG-(SHARK HAMER)-SK-20-8X60	

 590630540 VE 200 Nagelplug SHARK®Hammer TYPE FK ANK-SLAG-(SHARK HAMER)-FK-10-6X40	
 590630630 VE 200 Nagelplug SHARK®Hammer TYPE FK ANK-SLAG-(SHARK HAMER)-FK-5-6X30	
 590630650 VE 200 Nagelplug SHARK®Hammer TYPE FK ANK-SLAG-(SHARK HAMER)-FK-20-6X50	
 590630680 VE 200 Nagelplug SHARK®Hammer TYPE FK ANK-SLAG-(SHARK HAMER)-FK-50-6X80	
 590631640 VE 200 Nagelplug SHARK® Hammer TYPE SK ANK-SLAG-(SHARK HAMER)-SK-10-6X40	
 590631680 VE 200 Nagelplug SHARK® Hammer TYPE SK ANK-SLAG-(SHARK HAMER)-SK-50-6X80	
 5906318120 VE 100 Nagelplug SHARK® Hammer TYPE SK ANK-SLAG-(SHARK HAMER)-SK-80-8X120	
 5906318160 VE 100 Nagelplug SHARK® Hammer TYPE SK ANK-SLAG-(SHARK HAMER)-SK-120-8X160	

SLAGPLUG / NAGELPLUG

NIEUW



Shark hammer, nagelplug Type SK verzonken kraag



Maten: 6 x 40 t/m 8 x 160

Meest gebruikt:

6 x 40 / 6 x 60 / 8 x 60 / 8 x 100

- Nagel gehard staal
- Verzinkt
- Blauw gepassiveerd

Art.nr. 5906 31 (maat)

Voorbeeld

6 x 80 = 5906 316 80



Slagplug wit, nagelplug W-ZN Type FK vlakke kraag



Maten: 5 x 25 t/m 8 x 45

Meest gebruikt:

6 x 40 / 6 x 60 / 6 x 80

- Nagel gehard staal
- Verzinkt
- Blauw gepassiveerd

Art.nr. 5906 30 (maat)

Voorbeeld

6 x 60 = 5906 306 60



Nagelplug W-ND

- Voor bevestiging in beton, volle steen, kalkzandsteen, gasbeton, holle baksteen
- Ideaal voor bijvoorbeeld de afbouw en elektriciens



Nagelplug W-ND/FK Ø 6 mm



Nagelplug W-ND/SK Ø 6 mm



Nagelplug W-ND/SK Ø 8 mm

Type plugkop	Plug-Ø mm	Pluglengte mm	Bevestigingshoogte mm	Art.nr.
FK - vlakke kraag	5	35	5	5907 105 035
FK - vlakke kraag	6	40	10	5907 106 040
FK - vlakke kraag	6	60	30	5907 106 060
SK - verzonken kraag	6	40	10	5907 206 040
SK - verzonken kraag	6	60	30	5907 206 060
SK - verzonken kraag	6	80	50	5907 206 080
SK - verzonken kraag	8	60	20	5907 208 060
SK - verzonken kraag	8	80	40	5907 208 080
SK - verzonken kraag	8	100	60	5907 208 100

WÜRTH BARCODE PLUGGEN & FIX HULS

590680636 VE 200
2C universele plug SHARK® TWIST Eén anker. Ac
PLUG-SHARK-TWIST-6X36

590681056 VE 100
2C universele plug SHARK® TWIST Eén anker. Ac
PLUG-SHARK-TWIST-10X56

590681476 VE 20
2C universele plug SHARK® TWIST Eén anker. Ac
PLUG-SHARK-TWIST-14X76

0903251 VE 200
Gipsplaatplug W-GS
PLUG-(W-GS/K)-PLA-14,5X33

090506 40 VE 100
Borghuls Staal geel verzinkt
FIX-HULS-(A2K)-6X40

090506 60 VE 100
Borghuls Staal geel verzinkt
FIX-HULS-(A0K)-30-6X60

090508 110 VE 100
Borghuls Staal geel verzinkt
FIX-HULS-(A0K)-70-8X110

090508 70 VE 100
Borghuls Staal geel verzinkt
FIX-HULS-(A0K)-30-8X70

0903253 VE 200
Gipskartonplug W-GS type ZD
ANK-(W-GS/ZL)-ZD-14X39

590620635 VE 200
Kunststof universele plug SHARK® Pro
ANK-(SHARKPRO)-KST-6X35

590621056 VE 100
Kunststof universele plug SHARK® Pro
ANK-(SHARKPRO)-KST-10X56

590680846 VE 200
2C universele plug SHARK® TWIST Eén anker. Ac
PLUG-SHARK-TWIST-8X46

590681266 VE 50
2C universele plug SHARK® TWIST Eén anker. Ac
PLUG-SHARK-TWIST-12X66

090506 30 VE 100
Borghuls Staal geel verzinkt
FIX-HULS-(A0K)-5-6X30

090506 50 VE 100
Borghuls Staal geel verzinkt
FIX-HULS-(A2K)-6X50

090506 80 VE 100
Borghuls Staal geel verzinkt
FIX-HULS-(A0K)-50-6X80

090508 130 VE 50
Borghuls Staal geel verzinkt
FIX-HULS-(A0K)-90-8X130

090508 90 VE 100
Borghuls Staal geel verzinkt
FIX-HULS-(A0K)-50-8X90

590620528 VE 200
Kunststof universele plug SHARK® Pro
ANK-(SHARKPRO)-KST-5X28

590620846 VE 200
Kunststof universele plug SHARK® Pro
ANK-(SHARKPRO)-KST-8X46

590621266 VE 50
Kunststof universele plug SHARK® Pro
ANK-(SHARKPRO)-KST-12X66

PLUGGEN & FIX HULS

Plug nylon

Basis plug nylon voor **volle ondergronden**

- Ø 5 mm
Art.nr. 0903 5 25
- Ø 6 mm
Art.nr. 0903 6 30
- Ø 8 mm
Art.nr. 0903 8 40
- Ø 10 mm
Art.nr. 0903 10 50

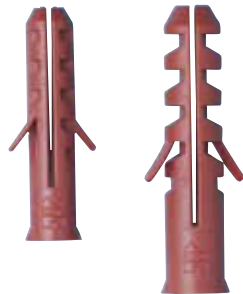

Spanhuls



- Binnen gebruik
- Tijdelijke bevestigingen in beton, volle steen en kalkzandsteen

- Ø 6 mm - 30, 40, 50, 60 en 80 mm lang
Art.nr. 0905 06 ..
- Ø 8 mm - 70, 90, 110, 130 en 150 mm lang
Art.nr. 0905 08 ...

Plug Zebra shark Pro

- Betere plug die zich **verknot**
- Beton, kalkzandsteen, holle steen, gipskarton en gasbeton
- **Volle en holle ondergronden**

Verkrijgbaar in diameter 5 t/m 12 mm
Art.nr. 5906 2... ..



Gipskartonplug W-GS Assortiment

401 stuks in systeemkoffer 4.4.1. Voor secundaire bevestigingen in gipsplaat/vezelplaat en lichte bouwplaat.

Art.nr. 5964 090 301



Universele plug SHARK® TWIST

Innovatief: 8-voudige verknottung met extreem groot contactoppervlak

Kan worden gebruikt in beton, massieve baksteen, volle kalkzandsteen, holle baksteen, holle kalkzandsteen, gasbeton, gipsplaat, gipsvezelplaat

Verkrijgbaar in diameter 6 t/m 14 mm
Art.nr. 5906 8... ..



Gipskartonplug metaal

Gipskarton, lichte bouwplaten

- Zinkdruk
- Type ZL

Art.nr. 0903 253



Gipskartonplug kunststof

Gipskarton, lichte bouwplaten

- Wit
- Type GS/K

Art.nr. 0903 251





AANVRAAG PROJECT ADVIES

Contact gegevens klant	Benodigde gegevens	Ja	Nee
Bedrijf	Takeningen tegenwoord d.d.		
Contactpersoon	Adres beschikbaar d.d.		
Adres	Takeningen architect	Ja	Nee
Telefoonnummer	Takeningen constructeur	Ja	Nee
Mail	EPC/Beng constructeur	Ja	Nee
Deliveren in:	Adres spoorwester	Ja	Nee
	Opmerking		
Contact gegevens project			
Project naam	Adres verankering	Ja	Nee
Uitvoerder	Opmerking		
Adres	Adres luchtdichting	Ja	Nee
Postcode/Woningnaam	Opmerking		
Telefoonnummer	Adres constructieve houtbouw	Ja	Nee
Mail	Opmerking		
Ext. Project datab. nr.	Adres brandwerende doorvoeren	Ja	Nee
	Opmerking		

PROJECTADVIES NODIG?

Projectadvies nodig op het gebied van verankering, luchtdichting, constructieve houtbouw of brandwerende doorvoeren?

Vul dan het formulier in en stuur het naar projectadvies@wurth.nl

Scan de QR-code om het formulier te openen



TECHNISCHE SOFTWARE

De rekensoftware van Würth is geschikt voor o.a. houtbouwers, constructeurs, ontwerpers en architecten. De berekeningssoftware omvat rekenmodules voor verankering, houtconstructie schroeven, WIT-REBAR, RELAST-anker, brandwerende systemen, solar-bevestigingen en Varifix-installatiesystemen. De software is volledig kosteloos te gebruiken!



Scan de QR-code voor meer informatie



DE NIEUWE WET KWALITEITS- BORGING

Ontdek wat dit betekent voor jou als
aannemer en hoe Würth je daarin kan
ondersteunen



*Scan de QR-
code voor meer
informatie*



PROJECT- REFERENTIES

Op de Projectreferentie-pagina kunt u onze
projectreferenties bekijken. Zo ziet u een aantal
uitgelichte producten die we recent aan onze
bouwklanten hebben geleverd. Op de foto's kunt
u zien voor welke toepassingen de producten
zoal gebruikt worden.

*Scan de QR-
code voor meer
informatie*



WÜRTH BARCODE SCHROEFANKERS



5929121005 VE 25
W-BS type S, zeskantkop, St.vz. ANK-(W-BS/S)-
(A2K)-SW15-5-
10X60



5929121035 VE 25
W-BS type S, zeskantkop, St.vz. ANK-(W-BS/S)-
(A2K)-SW15-5-35-
10X90



5929121065 VE 25
W-BS type S, zeskantkop, St.vz. ANK-(W-BS/S)-
(A2K)-SW15-35-65-
10X120



5929122045 VE 25
W-BS type S, zeskantkop, St.vz. ANK-(W-BS/S)-
(A2K)-SW17-10-45-
12X110



5929126025 VE 100
W-BS type S, zeskantkop, St.vz. ANK-(W-BS/S)-
(A2K)-SW13-5-25-
6X60



5929128005 VE 50
W-BS type S, zeskantkop, St.vz. ANK-(W-BS/S)-(A2K)-
SW13-5-
8X50



5929128025 VE 50
W-BS type S, zeskantkop, St.vz. ANK-(W-BS/S)-
(A2K)-SW13-5-25-
8X70



5929128045 VE 50
W-BS type S, zeskantkop, St.vz. ANK-(W-BS/S)-(A2K)-
SW13-25-45-
8X90



5929136025 VE 100
W-BS type SK, verzonken kop, St.vz. ANK-
(W-BS/SK)-(A2K)-TX30-5-25-
6X60



5929136065 VE 100
W-BS type SK, verzonken kop, St.vz. ANK-
(W-BS/SK)-(A2K)-TX30-45-65-
6X100



5929914131 VE 25
Betonschroef W-BS-T, tijdelijke bevestig...
ANK-(W-BS-T)-KRAAG-A2K-SW24-15-14X130



5929121025 VE 25
W-BS type S, zeskantkop, St.vz. ANK-(W-BS/S)-
(A2K)-SW15-5-25-
10X80



5929121045 VE 25
W-BS type S, zeskantkop, St.vz. ANK-(W-BS/S)-
(A2K)-SW15-15-45-
10X100



5929122015 VE 25
W-BS type S, zeskantkop, St.vz. ANK-(W-BS/S)-
(A2K)-SW17-15-
12X80



5929126015 VE 100
W-BS type S, zeskantkop, St.vz. ANK-(W-BS/S)-
(A2K)-SW13-10-15-
6X50



5929126045 VE 100
W-BS type S, zeskantkop, St.vz. ANK-(W-BS/S)-
(A2K)-SW13-25-45-
6X80



5929128015 VE 50
W-BS type S, zeskantkop, St.vz. ANK-(W-BS/S)-
(A2K)-WS13-5-15-
8X60



5929128035 VE 50
W-BS type S, zeskantkop, St.vz. ANK-(W-BS/S)-
(A2K)-SW13-15-35-
8X80



5929128055 VE 50
W-BS type S, zeskantkop, St.vz. ANK-(W-BS/S)-
(A2K)-SW13-35-55-
8X100



5929136045 VE 100
W-BS type SK, verzonken kop, St.vz. ANK-
(W-BS/SK)-(A2K)-TX30-25-45-
6X80

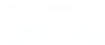

5929156005 VE 100 Betonschroef ANK
(W-BS/LP)-(A2K)-TX30-5-
6X40



5929914130 VE 25
Betonschroef W-BS-T, tijdelijk
ANK-(W-BS-T)-(A2K)-SW22-15-14X130



SCHROEFANKERS

Schroefanker, betonschroefanker W-BS

Ø 8 - 14 mm

Beton, volle steen, kalkzandsteen, drukvaste natuursteen, **gescheurd en ongescheurd beton** en kanaalplaatvloeren (Ø 6 mm)

- **Momentsleutel NIET vereist** (tijdbesparend)
- Bij indraaien snijdt anker zelf draadgangen in geboorde gat
- Compleet demonteerbaar
- (Na)stelmogelijkheden
- Staal verzinkt (ook verkrijgbaar in RVS A4)

**DE W-BS BETONSCROEF STAAL VERZINKT IN
FORMAAT 5 - 10 MM IS NU OOK UITGEBREID
GETEST IN METSELWERK!**



W-BS / S

Zeskantkop met aangepaste ring

Art.nr. 5929 12 ...



W-BS / SK

Verzonken kop (TX..)

Art.nr. 5929 13 ...



W-BS / LP

Large panhead (TX30)

Art.nr. 5929 156 ...



Betonschroef W-BS-T

Voor schoorbevestiging

W-BS-T

Met aangepaste ring en kraag

Herbruikbare betonschroef voor tijdelijke montage van bouwplaatsvoorzieningen met goedkeuring in vers beton

Art.nr. 5929 914 131



W-BS-T

Met aangepaste ring

Herbruikbare betonschroef voor tijdelijke montage van bouwplaatsvoorzieningen met goedkeuring in vers beton

Art.nr. 5929 91. ...



*Voor meer informatie
scan de QR-code:*



BIT TX30

Art.nr. 0614 313 0



Gebbruiksaanwijzing



Gat boren



Boorgat reinigen



Anker plaatsen

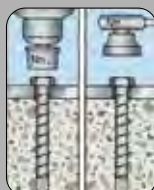

Anker inschroeven

ANKERS MECHANISCH

FIXanker W-FAZ/S

Anker voor **gescheurd en ongescheurd beton**

- Europese technische goedkeuring
- Staal verzinkt
- Met momentsleutel aandraaien



Maten M8 t/m M27
Art.nr. 5929 2... ..



FIXanker W-FA/S

Anker voor **ongescheurd beton**

- Europese technische goedkeuring
- Staal verzinkt
- Met momentsleutel aandraaien

Maten M6 t/m M20
Art.nr. 5932 0... ..

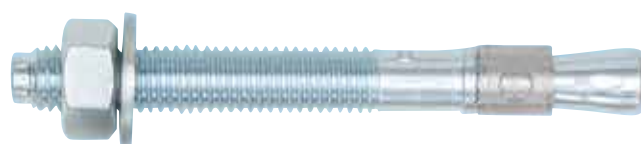

FIXanker W-FAZ/A4

RVS A4
 Maten M8 t/m M24
Art.nr. 5928 4... ..



FIXanker W-FA/A4

RVS A4
 Maten M6 t/m M20
Art.nr. 0904 411



Momentsleutel 1/2" 20-100Nm

Art.nr. 0714 71 22
 Andere modellen 0714 71 2..



Meer info www.wurth.nl

- Service
- Downloadcenter
- Brochures
- Ankers en pluggen



Krachtdop 1/2"

Art.nr. 0714 13 ..



Technische ondersteuning

073 - 629 1530
 o.a. verzorgen trekproeven



ANKERS CHEMISCHE VERANKERING

Injectiemortel

WIT-PM200

300 ml

Art.nr. 5918 242 300

Metselwerk, kalkzandsteen

Ongescheurd beton

Kan met standaard kitpistool verwerkt worden of met special kitpistool art.nr. 0891 003



Injectiemortel

WIT-VM250

420 ml

Art.nr. 0903 450 205

Metselwerk

Gescheurd en ongescheurd beton

Rebar: achteraf inlijmen van wapeningsstaven



Injectiemortel

WIT-UH 300

420 ml

Art.nr. 5918 500 420

Gescheurd en ongescheurd beton

Beton en drukvaste natuursteen
Extreem hoge belastingswaarden
Rebar: achteraf inlijmen van wapeningsstaven



Injectiemortel

WIT-PE 1000

585 ml

Art.nr. 5918 605 585

Ideaal injectiesysteem voor grote verankeringsdieptes en boorgatdiameters:

Gescheurd en ongescheurd beton





ANKERS CHEMISCHE VERANKERING

Ankerstang

Art.nr. 5915 ...

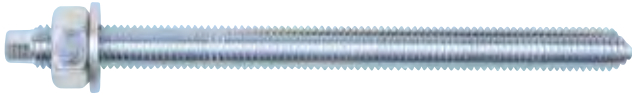

Ankerstang W-VD-A

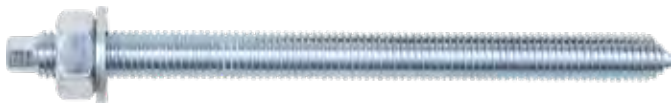

Beton

Staal verz. Art.nr. 5915 3.. ...

A4 Art.nr. 5915 2.. ...

Ankerstang W-VI-A

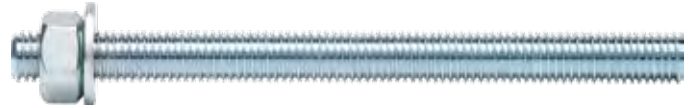

Metselwerk + beton

Staal verz. Art.nr. 0905 46. ...

A4 Art.nr. 0905 47. ...

Draadeind 1 m



Metselwerk + beton

Staal verz. Art.nr. 5916 0.. ...

A4 Art.nr. 5916 1.. ...

Verwerkingspistool WIT-Multi

Art.nr. 0891 003 105



Blaasbalg

Art.nr. 0903 990 001



Reinigingsborstels

Art.nr. 0903 489 6..



Toebehoren

Metselwerk

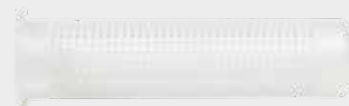

Zeehuls SH 16 x 85 M8 + M10

Art.nr. 0903 44 164

Zeehuls SH 20 x 85 M12 + M16

Art.nr. 0903 44 203

Toebehoren voor boorgatreiniging niet vergeten.



VARIFIX
HET MONTAGERAILSISTEEM
VOOR DE INSTALLATIEBRANCHE

INZETBAAR VOOR VELE TOEPASSINGEN

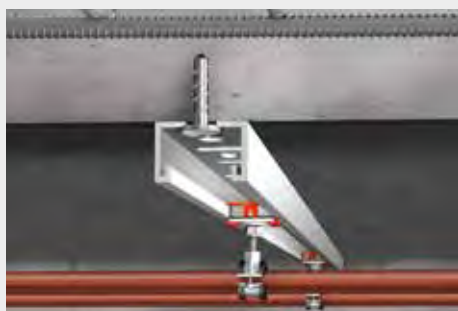

CRADLE TO CRADLE CERTIFIED™

STRENGSTE NORM VOOR ECO-EFFICIËNTIE

De voordelen van het Cradle to Cradle®-gecertificeerde VARIFIX® snelmontagesysteem voor planners, architecten, bouwheren en vakbedrijven:

- ✓ Hoge flexibiliteit, veelzijdige onderdelen en minimale montagekosten bij verbouwingen
- ✓ Materiaalwaarde blijft behouden, ongeacht gebruiksperiode
- ✓ Veiligheid bij planning en keuze van onderdelen
- ✓ Revaluatie van het gebouw met materialen die getest zijn op schadelijke stoffen
- ✓ Beproefde maatschappelijke en duurzame kwaliteit
- ✓ Onafhankelijk bewijs over de hele toeleveringsketen
- ✓ Veilige terugname/recycleerbaarheid en procesoptimalisatie
- ✓ Onafhankelijke en neutrale certificering
- ✓ Imagoverbetering door het gebruik van innovatieve onderdelen
- ✓ Uitgebreide toepassingsmogelijkheden voor duurzaam bouwen en gebouwcertificering volgens LEED®, BREEAM® en DGNB
- ✓ Katalysator voor de verdere ontwikkeling van interne duurzaamheidsprocessen bij bouwprojecten en bouwheren

Als Cradle to Cradle®-gecertificeerd bouwproduct is VARIFIX® de juiste keuze voor aanbestedingen volgens LEED®, BREEAM®- en DGNB-criteria:



LEED® - Leadership in Energy and Environmental Design - is het waarderingssysteem van de US Green Building Council. Het vergelijkt regionaal en lokaal toegepaste criteria met globale normen. Het gebruik van bouwstoffen met een Cradle to Cradle®-bewijs levert bonuspunten op.
www.usgbc.org



BREEAM - Building Research Establishment Environmental Assessment Method - is het Britse duurzaamheidscertificaat voor bouwprojecten. Het wordt buiten het VK ook in 15 andere landen gebruikt. In Nederland wordt daarbij het gebruik van Cradle to Cradle®-gecertificeerde bouwstoffen beloond.
www.breeam.org



DGNB is het certificeringssysteem van de Deutsche Gesellschaft für Nachhaltiges Bauen (Duitse vereniging voor duurzaam bouwen) en het Duitse Bondsministerie van Vervoer, Bouw en Stadsontwikkeling. Het beoordeelt de kwaliteit van de volledige levenscyclus van gebouwen en wordt internationaal gebruikt.
www.dgnb.de



OVERZICHT MONTAGERAILS

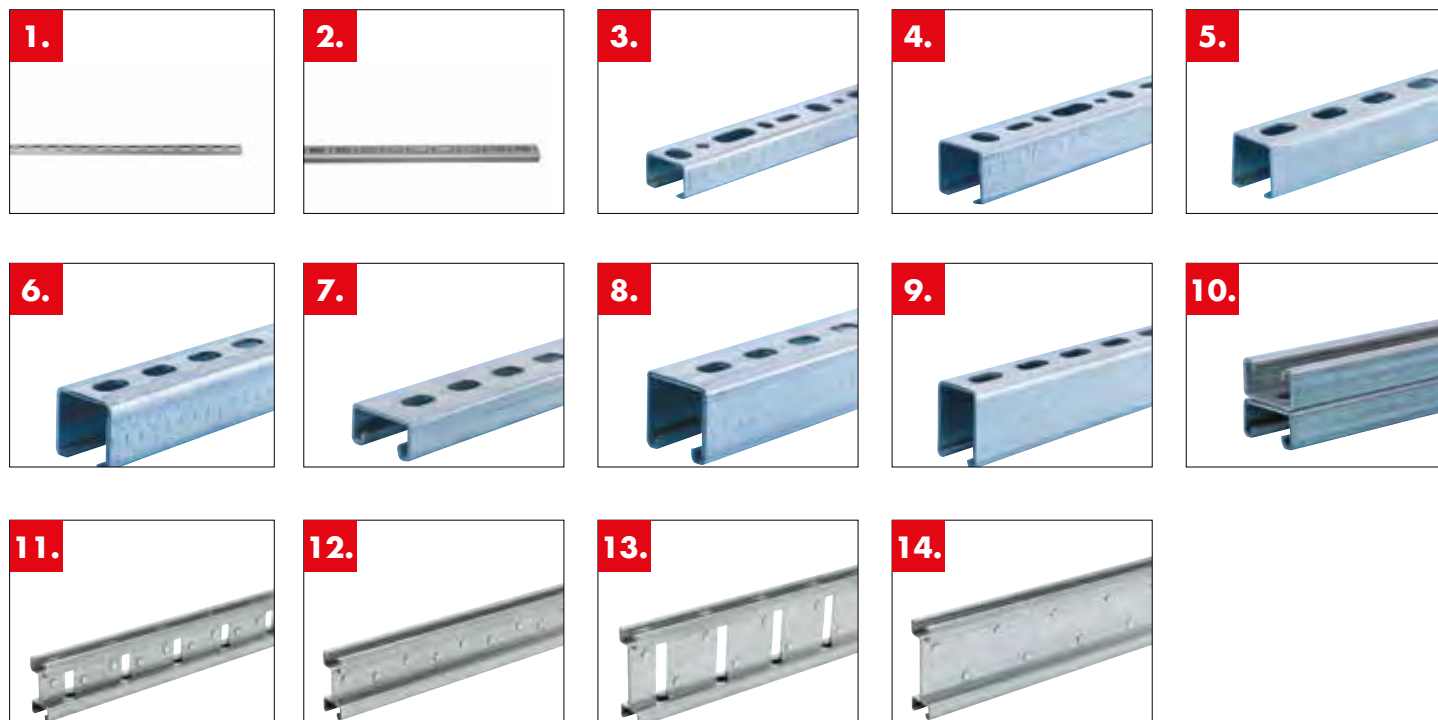

Afbeelding	Omschrijving	Art.nr.	Lengte meter	Materiaaldikte mm
1	30/15	9501 012 920	2	2
2	34/20	9501 012 919	2	2
3	26/18	0862 001 001	2	1,25
		0862 001 221	3	1,25
4	26/26	0862 001 002	2	1,25
		0862 001 222	3	1,25
5	28/28	0862 001 003	2	1,75
		0862 001 223	3	1,75
6	36/36	0862 001 004	2	2,5
		0862 001 224	3	2,5
		0862 001 230	6	2,5
7	41/22	0862 001 005	2	2,5
		0862 001 225	3	2,5
		0862 001 229	6	2,5
		0862 001 233	3	1,8
		0862 001 235	6	1,8
8	41/41	0862 001 007	2	1,8
		0862 001 227	3	1,8
		0862 001 237	6	1,8
		0862 001 006	2	2,5
		0862 001 226	3	2,5
		0862 001 231	6	2,5
9	41/62	0862 001 242	3	3
		0862 001 232	6	3
10	41/44	0862 001 250	3	2,5
		0862 001 251	6	2,5
11	41/86	0862 001 300	3	2
		0862 001 305	6	2
12	41/86	0862 001 310	6	2
13	41/128	0862 001 330	3	2,5
		0862 001 335	6	2,5
14	41/128	0862 001 340	6	2,5





















OVERZICHT MONTAGEBEUGELS



Afbeelding	Art.nr.	Omschrijving	Klembereik	Bijzonderheden
1	0543060*	Pijpbeugel TIPP Smartlock GS ML	15 tot 115 mm	1500N tot 3000N
2	0543171*	Pijpbeugel TIPP Express	11 tot 115 mm	
3	0543058*	Leidingbeugel TIPP Smartlock GS	11 tot 115 mm	800N tot 1800N
4	0865068*	Leidingbeugel TIPP Smartlock GS A4	11 tot 114 mm	800N tot 1800N
5	0543204*	Leidingbeugel TIPP Smartlock 2 GS	11 tot 169 mm	1200N tot 1800N
6	0543210*	Pijpbeugel TIPP® Robuust	19 tot 328 mm	2000N tot 4500N
7	5254210*	Pijpbeugel TIPP® Robuust TZN	14 tot 225 mm	2000N tot 4500N
8	0865208*	Pijpbeugel TIPP® A4	12 tot 277 mm	1000N tot 3000N
9	0543215*	Pijpbeugel TIPP® SOLIDE zwaar gebruik	108 tot 408 mm	5000N tot 6666N
10	5254215*	Pijpbeugel TIPP® SOLIDE zwaar gebruik TZN	208 tot 408 mm	
11	0543903*	Pijpbeugel TIPP® SMARTLOCK GS	19 tot 123 mm	800N tot 1800N
12	0543905*	Pijpbeugel TIPP® SMARTLOCK 2 GS	21 tot 175 mm	1200N tot 1800N
13	0874303*	Koelbeugel PUR 250 TYPE 175	17 tot 219 mm	PUR Isolatie
14	0874313* en 0874319*	Koelbeugel K	11 tot 219 mm	Isolatie dikte 13 tot 26 mm
15	0874402* en 0874404*	Koelbeugel K plus	10 tot 114 mm	Isolatie dikte 2 en 4
16	0543830* en 0543831*	Ventilatiepijpbeugel TIPP® AERO	80 tot 12500 mm	
17	0543208*	Pijpbeugel TIPP® siliconen	11 tot 118 mm	
18	0543211*	Pijpbeugel TIPP® Robuust, siliconen	88 tot 225 mm	
19	0543550*	Pijpbeugel	17 tot 219 mm	
20	0862900*	TIPP® Vastpuntbeugel	17 tot 168 mm	

WÜRTH BARCODE LIJMEN & KITTEN

 0892215241 VE 1 MS hybride afdichtmiddel FIXIT-PLUS-TRANSPARANT-290ML	
 0892215244 VE 1 FIXIT Plus FIXIT-PLUS-ZWART-290ML	
 089251012 VE 1 Neutral Silicone Perfect SILIC.NEUTR. PERFECT ZWART 310ML	
 08925304 VE 1 Neutrale siliconen SILICONEN NEUTR. OXIM GRIJS 310 ML	
 089256011 VE 1 Siliconenkit acetaat, natte cel SILICONEN NATTE CEL ZILVERGRIJS 310ML	
 0893225116 VE 1 Constructielijm Fixit Power + High Tack FIXIT-HT-ZWART-290ML	
 08925602 VE 1 Siliconenacetaat badkamer SILICONEN NATTE CEL EDELWIT 310 ML	
 08925606 VE 1 Siliconenkit acetaat, natte cel SILICONEN NATTE CEL SANITAIR GRIJS 310ML	
 08925609 VE 1 Siliconenkit acetaat, natte cel SILICONEN NATTE CEL JASMIJN 310ML	

 0892215240 VE 1 FIXIT Plus FIXIT-PLUS-GRIJS-290ML	
 0892215242 VE 1 FIXIT Plus FIXIT-PLUS-WIT-290ML	
 08925301 VE 1 Neutrale siliconen SILICONEN NEUTR. OXIM TRANSPARANT 310 ML	
 08925302 VE 1 Neutrale siliconen SILICONEN NEUTR. OXIM WIT 310 ML	
 08925601 VE 1 Siliconenkit acetaat, natte cel SILICONEN NATTE CEL TRANSPARANT 310 ML	
 089256012 VE 1 Siliconenkit acetaat, natte cel SILICONEN NATTE CEL PERGAMON 310ML	
 089256015 VE 1 Siliconenacetaat badkamer SILICONEN NATTE CEL ZWART 310 ML	
 08925603 VE 1 Siliconenkit acetaat, natte cel SILICONEN NATTE CEL MANHATTEN GRIJS 310ML	
 08925608 VE 1 Siliconenkit acetaat, natte cel SILICONEN NATTE CEL TEGELWIT 310ML	
 0893225105 VE 1 Constructielijm Fixit Power + High Tack FIXIT-HT-WIT-290ML	

LIJMEN & KITTEN

Fixit Plus

Constructielijm 1K

Universeel verlijmen en afdichten voor binnen en buitentoepassingen

Wit

Art.nr. 0892 215 242

Zwart

Art.nr. 0892 215 244

Grijs

Art.nr. 0892 215 240

Bovenstaande lijmen voldoen aan de strengste emissie eisen: EC1+ gecertificeerd

Transparant

Art.nr. 0892 215 241

Met een treksterkte van 3,20 N/mm² is de transparante Fixit Plus sterker dan ooit tevoren.



Fixit power / high tack

Constructielijm 1K

- Lijmen en afdichten
- MS polymeer
- Hoge aanvangskleefkracht

Wit

Art.nr. 0893 225 105

Zwart

Art.nr. 0893 225 116



Siliconen neutraal

Siliconenkit

Transparant

Art.nr. 0892 530 1

Wit

Art.nr. 0892 530 2

Betongrijs

Art.nr. 0892 530 4



Siliconen acetaat

natte cel

Siliconenkit natte cel, voor natte ruimtes

Transparant

Art.nr. 0892 560 1

Edel wit

Art.nr. 0892 560 2

Manhattan grijs

Art.nr. 0892 560 3

Zwart

Art.nr. 0892 560 15

Ook verkrijgbaar in jasmijn, pergamon, tegelwit, sanitair- en zilvergrijs



LIJMEN & KITTEN

Acryl afdichtingsmiddel

- Opvullen en afdichten voegen
- Overschilderbaar
- Wit

Art.nr. 0892 165



Shell tixophalte

Waterdicht afdichten van naden in dakranden en schoorstenen

Donkergrijs

Art.nr. 0890 103 3



Spuitmond / mondstuk

Draaibaar 360°

Art.nr. 0891 600 004

VE/st. 20



Spuitmond / mondstuk

Art.nr. 0891 653 2

VE/st. 24

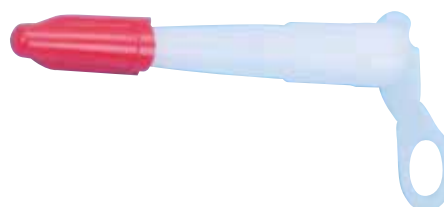

Kitspuit / handkitpistool

Premium

Art.nr. 0891 00



Kitspuit / handkitpistool

Basic

Art.nr. 0891 001

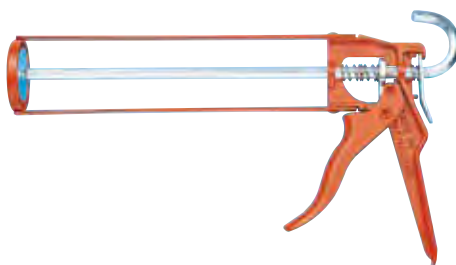

Kitspuit / handkitpistool

Robuust

Art.nr. 0891 310 1



PUR, PURCLEANER & PURPISTOLEN

**1-component-
schuim
Streetfighter
Flex**
750 ml

Beige
Art.nr. 0892 142 11



**1-component
pistoolschuim
Streetfighter
standaard**
750 ml

Geel
Art.nr. 0892 152 105



PUR reiniger
Art.nr. 0892 160



**UNIVERSEEL
1C-SCHUIM PU
ZERO WHITE**

Universeel Pur-schuim ZERO
Volledig isocyanaat-vrij

Art.nr. 0892 142 810



**1K PUR schuimpistool
PROMOTION**

Kunststof, 12 cm

Art.nr. 0891 152 806



**1K PUR schuimpistool
PROFI**

Metaal, 12 cm

Art.nr. 0891 152 802



**Constructielijm
PUR Rapid**

Transparant, KOMO
Art.nr. 0892 100 116



**Constructielijm
PUR Rapid**

Bruin
Art.nr. 0892 100 101























Montagekit

Geel
Art.nr. 0892 100 100



WÜRTH BARCODE PUR & CHEMIE

<p>08901087 VE 1 Remmenreiniger REMMENREINIGER 500 ML</p>		
<p>0891001 VE 1 Kitspuit handmatig Basis HANDPATRONENPISTOOL</p>		
<p>0891152806 VE 1 1K-schuimpistool Promotion SCHUIMPISTOOL KUNSTSTOF 12CM</p>		
<p>0891503013 VE 1 Pompnevelspuit, bedrukt, leeg POMPNEVELSPUIT VOOR HOLZGLEIT</p>		
<p>08916532 VE 24 Spuitsmond VULMONDSTUK</p>		
<p>0892160 VE 1 PURLOGIC® PU-schuimreiniger Schoon PURLOGIC CLEAN 500ML</p>		
<p>0893050004 VE 1 Boor- en snijolie CUT+COOL CUT EN COOL BOOR EN SNIJOLIE 400 ML</p>		
<p>0893070 VE 1 Woodslide GLIJMIDDEL-HOUT-5 L</p>		
<p>0893140 VE 1 Industriële reiniger INDUSTRIE-CLEAN SPUITBUS 500 ML</p>		
<p>08901033 VE 1 Bitumenafdichtmiddel Shell Tixophalte we... SHELL-TIXOPHALTE-WET-310ML</p>		
<p>0893055400 VE 1 Onderhoudsolie Multi Cobra MULTI SPRAY COBRA HEAD 400ML</p>		
<p>089309 VE 1 Secondelijm Supersnelle lijm LIJMFIX SUPERSNEL - DOSEERTUIT 20G</p>		
<p>0892142810 VE 12 Universeel 1C-schuim PU Zero White 1C-PURSCHUIM-ZERO-PLUS-CREMEWIT-750ML</p>		

<p>089100 VE 1 Kitpistool handmatig, hoge kwaliteit HANDKITPISTOOL 310 ML</p>		
<p>0891152802 VE 1 1K-schuimpistool Profi SCHUIMPISTOOL PROFI 12CM</p>		
<p>08913101 VE 1 Kitspuit handmatig Robuust KITPISTOOL TBV KOKERS 310 ML</p>		
<p>0891600004 VE 20 Spuitsmond MONDSTUK DRAAIBAAR TWISTY NOZZLE</p>		
<p>0892100109 VE 1 Constructielijm PUR RAPID KOMO RAPID-PUR CONSTRUCTIETIXTRANSP.KOMO310ML</p>		
<p>0892165 VE 1 Acrylkit ACRYL-AFDICHTINGSMIDDEL WIT 310 ML</p>		
<p>08938711 VE 1 Multifunctioneel vet II UNIVERSEEL SMEERVET II 400 G</p>		
<p>089214211 VE 12 Streetfighter Flex PISTOOLSCHUIM-K-FLEX-B3-750ML</p>		
<p>0892100100 VE 1 Montagekit MONTAGELIJM GEEL 310ML</p>		
<p>0892100101 VE 1 Constructielijm PUR Rapid RAPID-PUR CONSTRUCTIETIX 310 ML</p>		
<p>08930900 VE 1 Secondelijm Supersnelle lijm LIJMFIX SUPERSNEL- DOSEERTUIT 5 G</p>		
<p>0893090 VE 1 Secondelijm Supersnelle lijm LIJMFIX SUPERSNEL - DOSEERTUIT 50 G</p>		

CHEMIE

Remmen- reiniger

- Reinigen
- Ontvetten
- 500 ml

Art.nr. 0890 108 7



Multi onderhoudsspray

Cobra head, onderhoudsolie

- 400 ml

Art.nr.
0893 055 400



Industrie- cleaner

- 500 ml

Art.nr. 0893 140



Boor- en snijolie

- 400 ml

Art.nr. 0893 050 004



Holzgleit

- Glijmiddel hout
- 5 liter

Art.nr.
0893 070



Pompnevelspuit

Speciaal voor Holzgleit
(niet op barcodeblad)

Art.nr.
0891 503 013



Smeervet II

Smeervet universeel

- 400 gram

Art.nr. 0893 871 1



Supersnellijm

Secondelijm

5 gram
Art.nr. 0893 090 0

20 gram
Art.nr. 0893 09

50 gram
Art.nr. 0893 090



ISI!! GEVAARSTOFMANAGEMENT

Het besluit gevaarlijke stoffen regelt de omgang met gevaarlijke stoffen en dient om de mens en het milieu te beschermen tegen stofgerelateerde schade. Om u te helpen met het concentreren op het werk in plaats van op de regels, biedt Würth de uitgebreide online tool „ISI!! beheer van gevaarlijke stoffen” aan die zal helpen om eenvoudig en snel aan de wettelijke eisen te voldoen met veiligheidsinformatiebladen, RI&E, bedrijfsinstructies en het registreren van gevaarlijke stoffen.



Veiligheidsinformatiebladen actueel houden



Werkplekinstructiekaarten schrijven



Registratie van gevaarlijke stoffen



Voorlichting geven



Passende beschermende middelen kiezen



Bij de opslag van gevaarlijke stoffen op safe spelen



Folder beschikbaar www.wurth.nl
 Service → Veiligheid en milieu →
 ISI!! Gevaarstofmanagement

WÜRTH BARCODE TAPE



081244 660 VE 1
Markeringstape zelfklevend
GEVAREN/MARKERINGSTAPE-GEEL/ZWART-50



0874100050 VE 4
Tape
PVC TAPE GRIJS 50MM 20M



0894909004 VE 1
Montagetape Power
MONTAGETAPE POWER TRANSP. 19MM



0985050 VE 6
PVC-verpakkingstape
PVC-VERPAKKINGSTAPE-50MMX66M



099238150 VE 1
Universele tape
DUCT TAPE PREMIUM GAFFER ZWART 50MMX50



09855050 VE 1
Geweven tape
DUCT TAPE BASIC GRIJS 50MMX50MX0,175MM



081244 662 VE 1
Markeringstape zelfklevend
GEVARENTAPE-ROOD/WIT-50MMX33M



0874100200 VE 1
Geweven tape
TEXTIELTAPE- ALL WEATHER 50MX48MM



0985010200 VE 1
Bekistingstape
BEKISTINGSTAPE GEEL 50MMX33M



09850504 VE 6
PP-verpakkingstape
PP-PLAKBAND-TRANSPARANT-50MMX66M



099238138 VE 1
Universele tape
DUCT TAPE ZWART 38MMX50M



TAPE

Geweven tape

Basic grijs

- 50 mm breed / 50 meter op rol

Art.nr. 0985 505 0

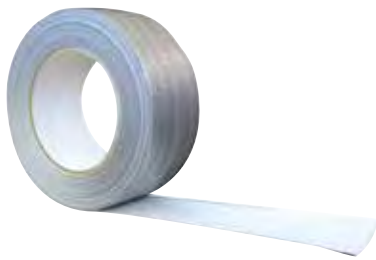

Duct tape textiel

Hoge aanvangsleeftkracht, grijs

- 48 mm breed / 50 meter op rol
- Voor binnen en **buiten**

Art.nr. 0874 100 200

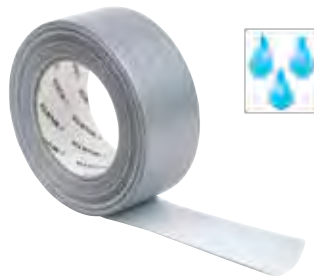

PVC tape

Donkergrijs

- 50 mm breed / 20 meter op rol
- Vochtbestendig

Art.nr. 0874 100 050

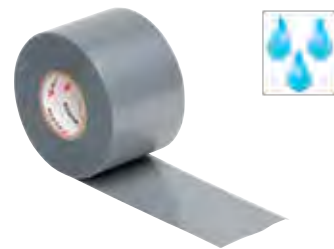

Bekistings tape

- Vocht-, olie- en vetbestendig
- 50 mm breed / 33 meter op rol

Art.nr. 0985 010 200

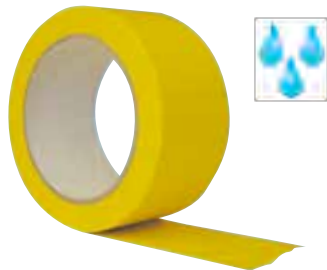

PVC transparante tape

- 50 mm breed / 66 meter op rol
- Hoge scheurvastheid

Art.nr. 0985 050

VE/st. 6

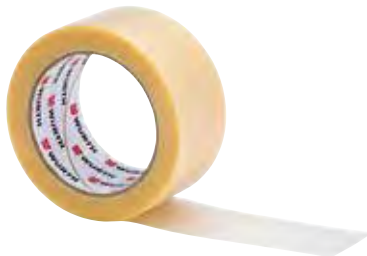

PP transparante tape

Basic

- Gunstig geprijsd

Art.nr. 0985 050 4

VE/st. 6



Gaffer tape / Duct tape

Zonder lijmresten te verwijderen

- 50 meter op rol
- Kort vochtbestendig

38 mm breed

Art.nr. 0992 381 38

50 mm breed

Art.nr. 0992 381 50



Montage tape, dubbelzijdig

Power tape, **transparant**

- Extreem hoge kleefkracht
- 19 mm breed / 10 meter op rol
- Vochtbestendig

Art.nr. 0894 909 004

Ook in andere maten verkrijgbaar

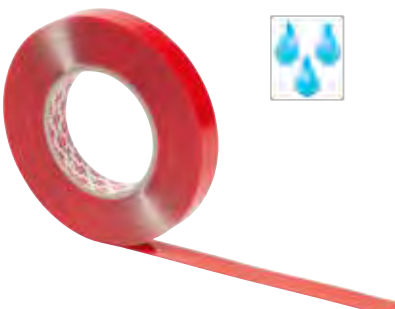

Markeringstape

PVC tape

- Gevaar markeren
- 50 mm breed / 33 meter op rol

Zwart geel

Art.nr. 0812 44 660

Rood wit

Art.nr. 0812 44 662



WÜRTH BARCODE TAPE & KWASTEN



069301106 VE 12
Ronde kwast LM ECONOMY Voor verf op basis ...
RONDE-KWAST-ECO-GR6



069301110 VE 12
Ronde kwast LM ECONOMY Voor verf op basis ...
RONDE-KWAST-ECO-GR10



0985077201 VE 1
Silicone reparatieband
SILICONEN TAPE ROOD 25MMX3M



0985077202 VE 1
Siliconenreparatieband
SILICONEN TAPE TRANSPARANT 25MMX3M



0985103 VE 10
Isolatieband, elektra
ISOLATIETAPE VDE 10M 15MM ROOD



0985105 VE 10
Isolatieband, elektra
ISOLATIETAPE VDE 10M 15MM BLAUW



0985109 VE 10
Isolatieband, elektra
ISOLATIETAPE VDE 10M 15MM GRN/GEEL



09851092 VE 10
Isolatieband, elektra
ISOLATIETAPE VDE 10M 15MM GROEN



0992000325 VE 9
Precisietape, crêpe
PRECISIE AFPLAKTAPE 25MMX50M



09920025 VE 12
Afplaktape, crêpe
AFPLAKBAND FIJNE CREPE 25MMX50M



069301108 VE 12
Ronde kwast LM ECONOMY Voor verf op basis ...
RONDE-KWAST-ECO-GR8



0985077200 VE 1
Silicone reparatieband
SILICONEN TAPE ZWART 25MMX3M



0985100 VE 10
Isolatieband, elektra
ISOLATIETAPE VDE 10 ROL DIV KLEUREN



0985102 VE 10
Isolatieband, elektra
ISOLATIETAPE VDE 10M 15MM WIT



0985104 VE 10
Isolatieband, elektra
ISOLATIETAPE VDE 10M 15MM BRUIN



0985107 VE 10
Isolatieband, elektra
ISOLATIETAPE VDE 10M 15MM GEEL



09851091 VE 10
Isolatieband, elektra
ISOLATIETAPE VDE 10M 15MM GRIJS



0992000319 VE 12
Precisietape, crêpe
PRECISIE AFPLAKTAPE 19MMX50M



09920019 VE 16
Afplaktape, crêpe
AFPLAKBAND FIJNE CREPE 19MMX50M



TAPE & KWASTEN

Afplaktape, Crêpe

Basic

- 50 meter op rol

19 mm breed

Art.nr. 0992 001 9

25 mm breed

Art.nr. 0992 002 5

VE/st. 12

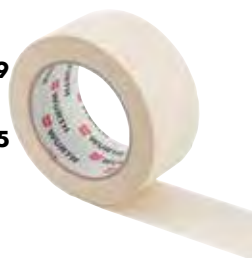

Siliconen-reparatieband



Zwart

Art.nr. 0985 077 200

Transparant

Art.nr. 0985 077 202



Precisietape, afplaktape crêpe



Zeer strakke lakrand

- 50 meter op rol

19 mm breed

Art.nr. 0992 000 319

25 mm breed

Art.nr. 0992 000 325

VE/st. 12/9

Ook verkrijgbaar in bredere maten



Elektro isolatietape

Zacht PVC folie

- 15 mm breed
- 10 meter op rol
- Scheurvast

Zwart

Art.nr. 0985 101

VE/st. 10

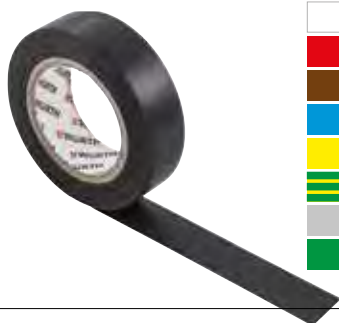

Art.nr. 0985 102

Art.nr. 0985 103

Art.nr. 0985 104

Art.nr. 0985 105

Art.nr. 0985 107

Art.nr. 0985 109

Art.nr. 0985 109 1

Art.nr. 0985 109 2

Assortiment elektro isolatietape

10 Rollen

Art.nr. 0985 100



Wegwerpkwast

Grootte 6

Art.nr. 0693 011 06

Grootte 8

Art.nr. 0693 011 08

Grootte 10

Art.nr. 0693 011 10



Verfrollers en beugels

Art.nr. 0693 01...

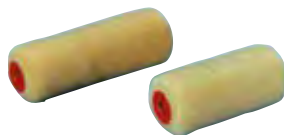
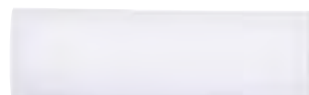















Kwasten

Art.nr. 0693 0... ..



WÜRTH BARCODE VERF, PLAMUUR & KWASTEN

 0693009011 VE 1 Stofveger AFSTBORST-CHW/PES-160X80MM-BL60MM	
 069301212 VE 1 Insteekbeugel Economic HANDGREEP ECO, 10/15CM	
 0693012015 VE 5 Verfbak Met afvoergebied VERFBAK-KUNSTSTOF-315X165X80MM	
 0695940903 VE 1 Schildersplamuurmes SCHILDERSPATEL, 30MM	
 0695940905 VE 1 Schildersplamuurmes SCHILDERSPATEL, 50MM	
 0695940908 VE 1 Schildersplamuurmes SCHILDERSPATEL, 80MM	
 0693012030 VE 5 Verfbak Met afvoergebied VERFBAK-KUNSTSTOF-350X355X105MM	
 NB0C1996 VE 6 Verf voor de bouw, andere YZERMENIE ROOD/BRUIN 750ML	

 0693010189 VE 10 Kleine lakroller van polyamide 2-K / ALKYDLAKVERF - RADIATORROL 10CM	
 06930114 VE 10 Kleine verfroller, Economic KLEINE ROL ECO, 10CM	
 06930124 VE 1 Verfemmer VERFEMMER, 12L	
 0695940902 VE 1 Schildersplamuurmes SCHILDERSPATEL, 20MM	
 0695940904 VE 1 Schildersplamuurmes SCHILDERSPATEL, 40MM	
 0695940906 VE 1 Schildersplamuurmes SCHILDERSPATEL, 60MM	
 0892603021 VE 1 Vuller VAKU 30 VULLER-FIJN-(VAKU-30)-1960G	
 NB0C1990 VE 6 Verf voor de bouw, andere SNELGROND WIT 750ML	

VERF, PLAMUUR & KWASTEN

Ijzermenie rood/bruin 750ml

Rood/Bruin
Art.nr. NBOC 199 6
VE/st. 6



Plamuur VAKU 30

• Universeel

Art.nr. 0892 603 021
VE/st. 1



Lakroller / verfroller

• Klein model, 10 cm breed
• Alkydlakverf

Art.nr. 0693 010 189
VE/st. 10



Lakroller / verfroller

• Klein model, 10 cm breed
• Basic lakverf

Art.nr. 0693 011 4
VE/st. 10



Plamuurmes

20 mm **Art.nr. 0695 940 902**

30 mm **Art.nr. 0695 940 903**

40 mm **Art.nr. 0695 940 904**

50 mm **Art.nr. 0695 940 905**

60 mm **Art.nr. 0695 940 906**

80 mm **Art.nr. 0695 940 908**

VE/st. 1



Verfbeugel

• Handgreep ECO
• Opsteekrollers 10/15 cm

Art.nr. 0693 012 12
VE/st. 1



Verfbeugel basis

• Incl. polyester verfroller 18 cm

Art.nr. 0693 010 7
VE/st. 1



Stofveger / stoffer

• 16 cm lang

Art.nr. 0693 009 011
VE/st. 1



Verfbakje

Voor rollers tot 15 cm

Art.nr. 0693 012 015
VE/st. 1



Verfbakje met afvoergebied

350 x 355 x 105 mm

Art.nr. 0693 012 030
VE/st. 1



Verfemmer

12 liter

Art.nr. 0693 012 4
VE/st. 1



WÜRTH BARCODE KABELBANDJES / BUNDELBANDJES

 050211 VE 100 Kabelbinder, standaard, met kunststof sl... KBLBA-KST-CLIP-NATUREL- 2,5X100	WIT	 0502111 VE 100 Kabelbinder, standaard, met kunststof sl... KABELBINDER KUNSTOF ZWART 2,5X100
 050212 VE 100 Kabelbinder, standaard, met kunststof sl... KABELBINDER KUNSTOF- NATUREL- 3,6X140	WIT	 0502121 VE 100 Kabelbinder, standaard, met kunststof sl... KABELBINDER KUNSTOF ZWART 3,6X140
 050213 VE 100 Kabelbinder, standaard, met kunststof sl... KABELBINDER KUNSTOF- NATUREL- 3,5X200	WIT	 0502131 VE 100 Kabelbinder, standaard, met kunststof sl... KABELBINDER KUNSTOF ZWART 3,5X200
 0502135 VE 100 Kabelbinder, standaard, met kunststof sl... KABELBINDER KUNSTOF- NATUREL- 3,6X280	WIT	 05021351 VE 100 Kabelbinder, standaard, met kunststof sl... KABELBINDER KUNSTOF ZWART 3,6X280
 050214 VE 100 Kabelbinder, standaard, met kunststof sl... KABELBINDER KUNSTOF- NATUREL- 4,8X178	WIT	 0502141 VE 100 Kabelbinder, standaard, met kunststof sl... KABELBINDER KUNSTOF ZWART 4,8X178
 050215 VE 100 Kabelbinder, standaard, met kunststof sl... KABELBINDER KUNSTOF- NATUREL- 4,8X280	WIT	 0502151 VE 100 Kabelbinder, standaard, met kunststof sl... KABELBINDER KUNSTOF ZWART 4,8X280
 050216 VE 100 Kabelbinder, standaard, met kunststof sl... KABELBAND KUNSTOF- NATUREL- 4,8X360	WIT	 0502161 VE 100 Kabelbinder, standaard, met kunststof sl... KABELBINDER KUNSTOF ZWART 4,8X360
 050217 VE 100 Kabelbinder, standaard, met kunststof sl... KABELBINDER KUNSTOF- NATUREL- 7,8X180	WIT	 0502171 VE 100 Kabelbinder, standaard, met kunststof sl... KABELBINDER KUNSTOF ZWART 7,8X180
 050218 VE 100 Kabelbinder, standaard, met kunststof sl... KABELBINDER KUNSTOF- NATUREL- 7,8X370	WIT	 0502181 VE 100 Kabelbinder, standaard, met kunststof sl... KABELBINDER KUNSTOF ZWART 7,8X370
 050219 VE 100 Kabelbinder, standaard, met kunststof sl... KABELBINDER KUNSTOF - NATUREL - 7,8X540	WIT	 05021901 VE 100 Kabelbinder, standaard, met kunststof sl... KABELBINDER KUNSTOF ZWART 7,8X540
 0502201 VE 50 Kabelbinder, standaard, met kunststof sl... KBLBA-KST-CLP-NATUREL- 12,5X720	WIT	 05022011 VE 50 Kabelbinder, standaard, met kunststof sl... KABELBINDER KUNSTOF ZWART 12,5X720
 050205020 VE 1 Kabelbinderhouder, leeg KABELBANDHOUDER LEEG 4 VAKKEN		

KABELBANDJES / BUNDELBANDJES / TY-RAPS KABELBINDERS / TIE-RIPS / COLSONBANDJES



Maten: 2,5 x 100 t/m 12,5 x 1.000

Meest gebruikt in de bouw: zwart
4,8 x 280 / 4,8 x 360
3,6 x 200 / 7,8 x 360

Kabelbandjes zwart of wit

- Kunststof met kunststof sluiting
- Geen scherpe randen
- **Zwart is UV- en weersbestendig**

Art.nr. 0502 ...

Assortiment **zwart**

2,5 x 100	Art.nr. 0502 111
3,6 x 140	Art.nr. 0502 121
3,6 x 200	Art.nr. 0502 131
3,6 x 280	Art.nr. 0502 135 1
4,8 x 178	Art.nr. 0502 141
4,8 x 280	Art.nr. 0502 151
4,8 x 360	Art.nr. 0502 161
7,8 x 180	Art.nr. 0502 171
7,8 x 360	Art.nr. 0502 181
7,8 x 560	Art.nr. 0502 190 1
12,5 x 720	Art.nr. 0502 201 1

Assortiment **wit**

2,5 x 100	Art.nr. 0502 11
3,6 x 140	Art.nr. 0502 12
3,6 x 200	Art.nr. 0502 13
3,6 x 280	Art.nr. 0502 135
4,8 x 178	Art.nr. 0502 14
4,8 x 280	Art.nr. 0502 15
4,8 x 360	Art.nr. 0502 16
7,8 x 180	Art.nr. 0502 17
7,8 x 360	Art.nr. 0502 18
7,8 x 560	Art.nr. 0502 19
12,5 x 720	Art.nr. 0502 201

BOX leeg

Art.nr. 0502 050 20





Let op! Verkrijgbaar per 100 of 300 stuks / barcodes alleen 100 stuks verpakking

WÜRTH BARCODE

UITVUL- & DRUKPLATEN / STELWIGGEN



 8 7 1 4 3 1 8 0 3 0 2 6 1
 9501000192 VE 240
 Drukplaat zonder sleuf
 DRUKPLT-Z-SL-KS-ORANJE-70X70X2-34702





 8 7 1 4 3 1 8 0 3 0 2 2 3
 9501000194 VE 192
 Drukplaat zonder sleuf
 DRUKPLT-Z-SL-KS-BLAUW-70X70X4-34704



 8 7 1 4 3 1 8 0 3 0 1 5 3
 9501000197 VE 192
 Drukplaat zonder sleuf
 DRUKPLT-Z-SL-KS-GRIJS-70X70X7-34707



 8 7 1 4 3 1 8 0 4 6 3 1 6
 9501000235 VE 480
 Uitvulplaatjes met sleuf
 UITVULPLT-DOOS-KS-TRANSP-50X50X1-34601



 8 7 1 4 3 1 8 0 4 6 2 9 3
 9501000237 VE 192
 Uitvulplaatjes met sleuf
 UITVULPLT-DOOS-KS-ZWART-50X50X3-34603



 8 7 1 4 3 1 8 0 4 6 2 7 9
 9501000239 VE 144
 Uitvulplaatjes met sleuf
 UITVULPLT-DOOS-KS-ROOD-50X50X5-34605





 8 7 1 4 3 1 8 0 3 0 4 7 6
 9501000241 VE 80
 Uitvulplaatjes met sleuf
 UITVULPLT-DOOS-KS-GROEN-50X50X10-34610





 8 7 1 4 3 1 8 0 4 7 7 3 3
 9501000246 VE 450
 Stelwig voor lijmblokken
 STELWIG-KS-ROOD-40X23X5X4G-340010



 8 7 1 4 3 1 8 0 3 0 2 4 7
 9501000193 VE 240
 Drukplaat zonder sleuf
 DRUKPLT-Z-SL-KS-ZWART-70X70X3-34703



 8 7 1 4 3 1 8 0 3 0 2 0 9
 9501000195 VE 192
 Drukplaat zonder sleuf
 DRUKPLT-Z-SL-KS-ROOD-70X70X5-34705



 8 7 1 4 3 1 8 0 3 0 1 3 1
 9501000198 VE 144
 Drukplaat zonder sleuf
 DRUKPLT-Z-SL-KS-GROEN-70X70X10-34710





 8 7 1 4 3 1 8 0 4 6 3 0 9
 9501000236 VE 240
 Uitvulplaatjes met sleuf
 UITVULPLT-DOOS-KS-ORANJE-50X50X2-34602



 8 7 1 4 3 1 8 0 4 6 2 8 6
 9501000238 VE 144
 Uitvulplaatjes met sleuf
 UITVULPLT-DOOS-KS-BLAUW-50X50X4-34604



 8 7 1 4 3 1 8 0 4 6 2 5 5
 9501000240 VE 96
 Uitvulplaatjes met sleuf
 UITVULPLT-DOOS-KS-GRIJS-50X50X7-34607





 8 7 1 4 3 1 8 0 3 0 9 4 0
 9501000243 VE 1
 Uitvulplaatjes assortimenten
 UITVULPLT-ASSORTIMENT-KS-50X50-34650



 8 7 1 4 3 1 8 0 6 0 1 0 7
 9501000248 VE 450
 Stelwig voor lijmblokken
 STELWIG-ABS-GROEN-40X23X5X4G-340015

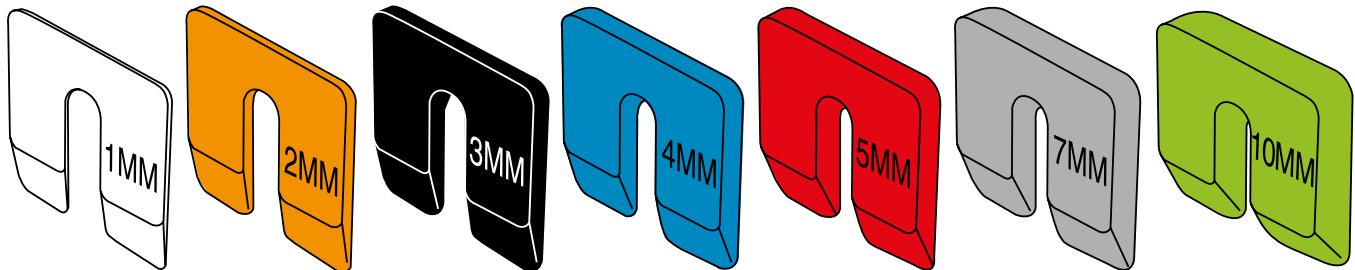

UITVUL- & DRUKPLATEN / STELWIGGEN



Uitvulplaatjes / stelplaatjes

1 mm	Transparant	Art.nr. 9501 000 235	In zak: 480 stuks
2 mm	Oranje	Art.nr. 9501 000 236	240 stuks
3 mm	Zwart	Art.nr. 9501 000 237	192 stuks
4 mm	Blauw	Art.nr. 9501 000 238	144 stuks
5 mm	Rood	Art.nr. 9501 000 239	144 stuks
7 mm	Grijs	Art.nr. 9501 000 240	96 stuks
10 mm	Groen	Art.nr. 9501 000 241	80 stuks

Assortimentskoffer

96 x 1 mm / 96 x 2 mm / 48 x 3 mm / 48 x 4 mm / 48 x 5 mm

Art.nr. 9501 000 243



Drukplaten zonder sleuf

2 mm	Oranje	Art.nr. 9501 000 192	In zak: 240 stuks
3 mm	Zwart	Art.nr. 9501 000 193	240 stuks
4 mm	Blauw	Art.nr. 9501 000 194	192 stuks
5 mm	Rood	Art.nr. 9501 000 195	192 stuks
7 mm	Grijs	Art.nr. 9501 000 197	192 stuks
10 mm	Groen	Art.nr. 9501 000 198	144 stuks



Stelwig

40 x 23 rood **Art.nr. 9501 000 246** 450 stuks
Kalkzandsteenwig





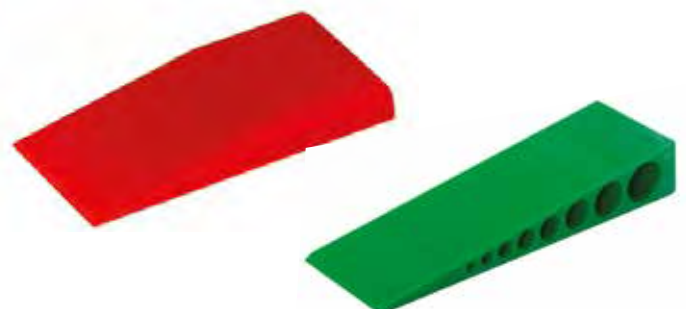





























145 x 45 x 25 groen **Art.nr. 9501 000 248** 25 stuks

Ook in andere maten verkrijgbaar



WÜRTH BARCODE

EENHAND- & SCHROEFKLEMMEN / TOUWEN / STELWIGGEN & UITVULPLAATJES

<p>0714662150 VE 1 Eenhandklem SNEL-SPANVIJS, 150MM</p>  	<p>0714662300 VE 1 Eenhandklem SNEL-SPANVIJS, 300MM</p>  
<p>0714662450 VE 1 Eenhandklem SNEL-SPANVIJS, 450MM</p>  	<p>0714662700 VE 1 Eenhandklem SNEL-SPANVIJS, 700MM</p>  
<p>071467430 VE 1 Schroefklem uit massief staal met houten... WURTH LIJMTANG G 30Z 300X140MM</p>  	<p>071467440 VE 1 Schroefklem uit massief staal met houten... WURTH LIJMTANG G 40Z 400X120MM</p>  
<p>071467450 VE 1 Schroefklem uit massief staal met houten... WURTH LIJMTANG G 50Z 500X120MM</p>  	<p>071467460 VE 1 Schroefklem uit massief staal met houten... WURTH LIJMTANG G 60Z 600X120MM</p>  
<p>9501000227 VE 1 Uitvulplaatjes assortimenten UITVLPLT-M-STELP-ASSOR-KS-50X50-34500</p>  	<p>9501000228 VE 768 Uitvulplaatje met stelootjes UITVLPLT-M-STLP-KS-TRANS-50X50X1-34501</p>  
<p>9501000232 VE 156 Uitvulplaatje met stelootjes UITVLPLT-M-STLP-KS-ROOD-50X50X5-34505</p>  	<p>9501000233 VE 108 Uitvulplaatje met stelootjes UITVLPLT-M-STLP-KS-GRUIS-50X50X7-34507</p>  
<p>9501000234 VE 78 Uitvulplaatje met stelootjes UITVLPLT-M-STLP-KS-GROE-50X50X10-34510</p>  	<p>9501000229 VE 384 Uitvulplaatje met stelootjes UITVLPLT-M-STLP-KS-ORAN-50X50X2-34502</p>  
<p>9501000230 VE 252 Uitvulplaatje met stelootjes UITVLPLT-M-STLP-KS-ZWART-50X50X3-34503</p>  	<p>9501000231 VE 192 Uitvulplaatje met stelootjes UITVLPLT-M-STLP-KS-BLAUW-50X50X4-34504</p>  
<p>0818070150 VE 1 Vervangende folie voor regenpijp REGENWATERAFVOERBUIS OP ROL 150M</p>  	

EENHAND- & SCHROEFKLEMMEN / TOUWEN / STELWIGGEN & UITVULPLAATJES

Touw polypropyleen

Oranje

6 mm x 100 m **Art.nr. 0997 511 069**

8 mm x 100 m **Art.nr. 0997 574 126**

10 mm x 100 m **Art.nr. 0997 529 822**

12 mm x 75 m **Art.nr. 0997 452 728**



Steigertouw

8 mm x 2,5 m

Art.nr. 0997 511 069



Schroefklem

Würth lijmtang

300 mm **Art.nr. 0714 674 30**

400 mm **Art.nr. 0714 674 40**

500 mm **Art.nr. 0714 674 50**

600 mm **Art.nr. 0714 674 60**

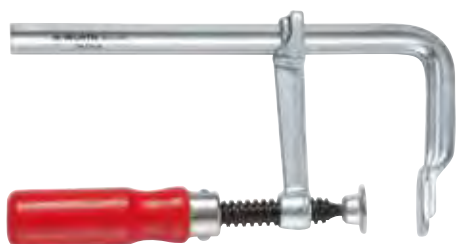

Eenhandklem

150 mm **Art.nr. 0714 662 150**

300 mm **Art.nr. 0714 662 300**

450 mm **Art.nr. 0714 662 450**

700 mm **Art.nr. 0714 662 700**



Vervangende folie voor regenpijp

Art.nr. 0818 070 150



Uitvulplaatjes met stelpoten assortiment

500 stuks

Art.nr. 9501 000 227



RUWBOUW & VEILIGHEID

GB GEBR. BODEGRAVEN BV
 verbindingen voor de bouw

Metalen randkist

- Geprofileerd
- Vloerhoogte 150 t/m 350

Art.nr. 9501 000 3..



Hoekstuk

t.b.v. metalen randkist

Art.nr. 9501 000 323

Art.nr. 9501 000 324

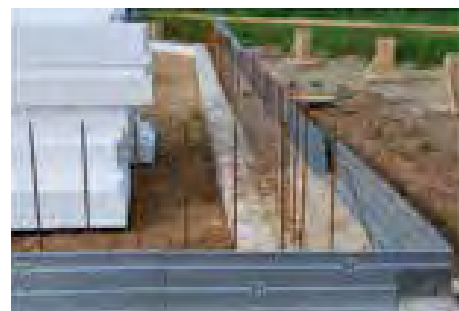

Spanners

Wartelspanner

Art.nr. 9501 000 355

Schietspanner

Art.nr. 9501 000 356



Randbekistingsanker

- Vlak
- Steigerplanken 32 mm

Art.nr. 9501 000 390



Randbekistingsanker Type 12

- Vloerhoogte 190 mm

Art.nr. 9501 000 391

Ook voor andere vloerhoogtes leverbaar



Kimverbreder

- Verbreden vloer
- T.b.v. stellen kimblokken

300 mm

Art.nr. 9501 000 415

1.000 mm

Art.nr. 9501 000 415



Randbeveiliging



RB beugel

- 65 x 5 t.b.v. steigerpijp Ø 4

Art.nr. 9501 000 396



RB lijmplaat

- Lijmen
- 117 x 126

Art.nr. 9501 000 398



ELEMENT- & KOZIJNVERBINDINGEN

HOEKANKERS / HOEKVERBINDINGEN

GB GEBR. BODEGRAVEN BV
verbindingen voor de bouw

Hoekanker

40 x 60 mm

Sendzimir verzinkt

Art.nr. **9501 001 058**
VE/st. 100



Hoekanker

90 x 90 mm

Sendzimir verzinkt

Art.nr. **9501 001 049**
VE/st. 100



Hoekanker met ril

90 x 90 mm

Sendzimir verzinkt

Art.nr. **9501 001 036**
VE/st. 100



XL hoekanker

75 x 100 mm

Sendzimir verzinkt

Art.nr. **9501 001 016**
VE/st. 30



Vloerkozijnstrip vlak

60 x 6 mm

Art.nr. **9501 001 872**
VE/st. 10



Vloerkozijnstrip knik

60 x 6 mm

Art.nr. **9501 001 873**
VE/st. 10



Aanbevolen

Beton: Superanker W-HAZ-S

Art.nr. **0905 212 002**
M8 / huls 12 / klem 10
VE/st. 50



Elementverankering /

J-anker **40 x 60 mm**

Hoekanker, sendzimir verzinkt

Art.nr. **9501 000 855**
VE/st. 30



Elementrubber

Art.nr. **9501 000 ...**
VE/st. 100



- | | |
|--------|---------|
| 15 x 6 | ... 865 |
| 15 x 8 | ... 866 |
| 20 x 6 | ... 867 |
| 20 x 8 | ... 868 |

Kanaalplaatvloeren: Kanaalplaatanker W-HD

Art.nr. **0905 12. ...**
M6 t/m M12



Art.nr. **0905 150 802**
Doorsteekmontage M8-10



ELEMENT- & KOZIJNVERBINDINGEN

GB **GEBR. BODEGRAVEN BV**
 verbindingen voor de bouw

Puisteun

Zink Magnesium

60 x 70 x 200 mm

Art.nr. 9501 000 898

VE/st. 15



Puisteun

Zink Magnesium

60 x 70 x 360 mm

Art.nr. 9501 000 905

VE/st. 15



Meer uitvoeringen

Art.nr. 9501 000 ...

- 60 x 70 x 160 mm
- 60 x 70 x 180 mm
- 60 x 70 x 200 mm
- 60 x 70 x 220 mm
- 60 x 70 x 240 mm
- 60 x 70 x 260 mm
- 60 x 70 x 280 mm
- 60 x 70 x 300 mm
- 60 x 70 x 320 mm
- 60 x 70 x 340 mm
- 60 x 70 x 360 mm
- 60 x 70 x 380 mm
- 60 x 70 x 400 mm
- 60 x 70 x 420 mm
- 60 x 70 x 440 mm
- 60 x 70 x 460 mm
- 60 x 70 x 480 mm
- 60 x 70 x 500 mm

Kozijnstelhoek

Type A

Art.nr. 9501 000 921

VE/st. 10



Andere uitvoeringen

Art.nr. 9501 000 9..



SPOUWANKERS & ISOLATIEBEVESTIGING

GB GEBR. BODEGRAVEN BV
 verbindingen voor de bouw

UNI-flexplug

Voor volle ondergronden

Beton, kalkzandsteen, baksteen

Zwart

Art.nr. 9501 000 4..

Juiste lengte = isolatiedikte + inslagdiepte
 binnenblad (40 - 60 mm)



UNI-perfoplug

Geperforeerde keramische binnenmuren

Geperforeerd baksteen

Art.nr. 9501 000 ...



UNI-clip

Kunststof klemring voor spouwmuurisolatie,

Ø 4 mm met condensstop

Rood

Art.nr. 9501 000 636

VE/st. 250



UNI-slagspouwanker

Met slagdraad

RVS A4 / 316!

Art.nr. 9501 000 5..

RVS A2 / 304

Art.nr. 9501 000 6..

VE/st. 250



Juiste lengte = lengte UNI-flexplug + luchtspouw
 + inlegdiepte buitenblad (45 - 75 mm)



UNI-indraaispouwanker

Met **houtdraad**, zonder punt, toepassing in
 plug voorheen (UNI-BOOR)

RVS A4 / 316!

Art.nr. 9501 000 6..

RVS A2 / 304

Art.nr. 9501 000 6..

VE/st. 250



Kraagplug

tbv UNI indraaispouwanker

Art.nr. 9501 000 568

VE/st. 1000



Eye-safe spouw

Voorkomen van letsel

Art.nr. 9501 000 345

VE/st. 250



Prikspouwanker

Gelijmde binnenmuren

RVS A4 / 316!

Art.nr. 9501 000 0..

RVS A2 / 304

Art.nr. 9501 000 65.

VE/st. 500



Scan de QR-code
 om alles te weten
 te komen over
 spouwverankering





Scan de QR-code voor meer informatie



Art.nr. 0681 352 401
VE/stuk 40



Gevelhoutverbinder Rocketclip

Het Rocketclip-systeem kan worden toegepast voor gesloten of halfopen gevelsystemen met geventileerde droge gevelbekleding. De drukvaste isolatieplaten (EPS, PIR en Kooltherm K15) zijn zowel horizontaal als verticaal toe te passen bij nieuwbouw en renovatiewerken.

Flexibel verwerkbaar

- De houten regels kunnen zowel horizontaal als verticaal in de klemmen gemonteerd worden

Koudebrugvrij systeem

Nagenoeg toepasbaar op alle type ondergronden

- CLT i.c.m. Assy® combi met alleen ring is voldoende
- Beton, kalkzandsteen, massief en geperforeerde stenen i.c.m. constructieplug SHARK® UR F

Toepassingsgebied

- Geschikt voor bevestiging op beton, kalkzandsteen, keramische snelbouwstenen, massief of geperforeerde stenen en CLT massief houten wanden
- Toepasbare harde isolatieplaten met een druksterkte vanaf 120 = Kpa: EPS, PIR, Resolschuim en Gutex multitherm houtvezelplaten. Andere isolatieplaten in overleg met adviseur

Opmerking

- De achterconstructie moet draagkrachtig genoeg zijn om optredende belastingen op te nemen en af te dragen
- Adviseren verduurzaamde houten regels van 44 x 44 mm toe te passen
- Voor gevelbekledingsgewicht boven de 35 kg per m2 dient u advies in te winnen bij adviseur
- Het hout dat wordt toegepast dient minimaal aan kwaliteitsklasse C18 te voldoen
- Zorg voor een vlakke ondergrond. Uitsteeksels en/of lijm-, en speciebaarden zoveel mogelijk verwijderen
- Maximale hoogte tot 20 meter boven maaiveld. Voor grotere hoogtes in overleg met adviseur



Foto's
Bouwbedrijf Vleeshouwers
Project: Molenbeek, Molenbeersel

Toebehoren

Constructieplug SHARK® UR F Staal verzinkt

Voor bevestiging op beton, kalkzandsteen, keramische snelbouwstenen, massief of geperforeerde stenen.



- Art.nr. 5912 810 602** 10x100 voor max. isolatiedikte (PIR) van 80 mm
- Art.nr. 5912 810 603** 10x115 voor max. isolatiedikte (PIR) van 100 mm
- Art.nr. 5912 810 604** 10x135 voor max. isolatiedikte (PIR) van 120 mm
- Art.nr. 5912 810 605** 10x160 voor max. isolatiedikte (PIR) van 140 mm
- Art.nr. 5912 810 606** 10x185 voor max. isolatiedikte (PIR) van 160 mm

ASSY® 4 Combi Houtbouwschroef Staal verzinkt

Deeldraad Zeskantkop. Voor bevestiging op CLT massief houten wanden.



- Art.nr. 0158 780 100**
8x100 op CLT voor max. isolatiedikte (Gutex multitherm) 100mm
- Art.nr. 0158 780 120**
8x120 op CLT voor max. isolatiedikte (Gutex multitherm) 120mm
- Art.nr. 0158 780 140**
8x140 op CLT voor max. isolatiedikte (Gutex multitherm) 140mm
- Art.nr. 0158 780 160**
8x160 op CLT voor max. isolatiedikte (Gutex multitherm) 160mm

ASSY® 4 A2 PH Bevestigingschroef A2 Roestvast staal blank

Voldraad Panhead.

Voor bevestiging van de regels op de Rocketclip.



Art.nr. 0187 740 30

Ring 8,4X20X1,25 A2K

Te gebruiken in combinatie met de ASSY® 4 Combi Houtbouwschroef.



Art.nr. 0411 8 20

Isolatieplug met spreidnagel W-DSDS Ø 50

Voor bevestiging van hardere, drukvaste isolatie zoals Styropor of hardschuim isolatieplaten op beton of metselwerk.



Art.nr. 0903 745 ...

1 component polyurethaanlijm

Voor het lijmen van polystyreen hardschuimplaten. Hecht aan alle gangbare bouwondergronden zoals: beton, metselwerk, steen, pleisterwerk, hout, metaal, polystyreen en bitumen.

Art.nr. 0892 152 125
VE/st. 12



Wütop® Gevelfolie 200 B

Damp-open folie, toepasbaar achter gedeeltelijk open gevelconstructies. Brandklasse: B1

Art.nr. 0681 001 23.
Verkrijgbaar in rolbreedte 1,5 m en 3 m

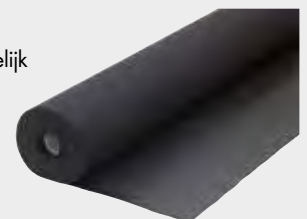

HOUTVERBINDINGEN

GB GEBR. BODEGRAVEN BV
verbindingen voor de bouw

Raveeldrager zwaar

59 x 160 mm / 2 mm

Art.nr. 9501 001 139

VE/st. 50



Raveeldrager zwaar

71 x 154 mm / 2 mm

Art.nr. 9501 001 141

VE/st. 50



Balkdrager korte lip

59 x 156 mm

Art.nr. 9501 001 242

VE/st. 10



Balkdrager lange lip

59 x 156 mm

Art.nr. 9501 001 200

46 x 121 mm

Art.nr. 9501 001 189

VE/st. 10



F-anker / muurplaatanker / dakvoetverbinding

Gelast

Voor houtmaat 71 mm

o.a. 70 x 250

Art.nr. 9501 001 527



F-anker / muurplaatanker / dakvoetverbinding

Voor houtmaat 71 mm

100 x 300

Art.nr. 9501 001 522



Ruitersteun

38

Art.nr. 9501 001 605

VE/st. 50



Muurplaatanker

Staal verzinkt

M10/M12 Art.nr. 9501 000 ...

Staal Blank

M16/M24 Art.nr. 9501 000 3..



LUCHTDICHT BOUWEN RAAM- EN DEURKOZIJNEN & BOUWAANSLUITINGEN

Afdichtingscoating / vloeibaar rubber

Worst 600 ml

- Vloeibaar rubber, specifiek geschikt voor het luchtdicht bouwen.
- Water- en luchtdicht afdichten van naden en kieren, hechting op vrijwel alle ondergronden.
- I.c.m Flexibele Pur als rugvulling, art.nr. 0892 142 91

Worstverpakking 600 ml

Art.nr. 0892 103 105

VE/st. 12



Emmer 5 liter

Art.nr. 0892 103 106

VE/st. 1



Emmer 10 liter

Art.nr. 0892 103 107

VE/st. 1



Purplus Flex

880 ml

1 component pistoolschuim flex

Art.nr. 0892 142 91

VE/st. 1



Handpistool

voor vloeibaar rubber worst

Art.nr. 0891 400 610



Accupistool AKP 18-600 COMPACT

set 3-delig

Art.nr. 5701 410 004



LUCHTDICHT BOUWEN RAAM- EN DEURKOZIJNEN & BOUWAANSLUITINGEN

Zelfklevende afdichtingstape / flexband actief

- Kozijnafdichtingsband
- **Binnen en buiten te gebruiken**
- Luchtdicht maken
- Slagregendicht membraan
- Zijde Würth logo kan gestuct worden
- Kleefstrip
- 50 meter op rol

Art.nr. 0875 591 ...

Verkrijgbaar in:

- 70 mm
- 100 mm
- 140 mm
- 200 mm
- 250 mm
- 300 mm
- 350 mm



Flexbandlijm plus

Koker 310 ml

In geval van een niet vlakke ondergrond, de flexband aanbrengen in combinatie met de flexbandlijm plus.

Art.nr. 0893 710 010



Elastische afdichtband Euraseal I-100

- Met kleefstrook
- Binnenzijde kozijnen
- Overstucbaar

Art.nr.

0875 571 070

0875 571 071

0875 571 100

0875 571 101

0875 571 150

Afmeting

70 mm x 25 m

70 mm x 80 m

100 mm x 25 m

100 mm x 80 m

150 mm x 25 m



LUCHTDICHT BOUWEN RAAM- EN DEURKOZIJNEN & BOUWAANSLUITINGEN



EPDM folie / afdichtband

- Voegen dichten **buiten**
- Vensterbanken, deur- en/of raamkozijnen
- Gevelbouw en buitendeurorpels
- Waterdicht en ademend
- Elastisch
- UV-bestendig

Art.nr. 0875 350 ..1

Met kleefstrook

Art.nr. 0875 350 ..2

Binnen, butyl kleefstrook

Art.nr. 0875 350 ..3

Buiten, butyl kleefstrook

Art.nr. 0875 350 ..4

Verkrijgbaar in:

150 mm

200 mm

250 mm

300 mm

400 mm

500 mm

EPDM Tape met zelfklevende butyllaag

De EPDM tape is een uit propyleen en ethyleen opgebouwde waterkerende, dampremmende en luchtdicht tape met butylen kleeflaag

- Blijvend elastisch
- UV-stabiel

Art.nr. 0875 700 200

Art.nr. 0875 700 300

Art.nr. 0875 700 400

Art.nr. 0875 700 600

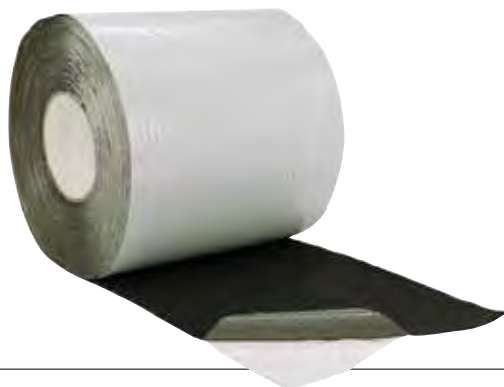

Butylprimer spray

500 ml

Art.nr. 0893 876 002



EPDM folielijm

Worst 600 ml

Art.nr. 0893 700 150

VE/st. 20



LUCHTDICHT BOUWEN RAAM- EN DEURKOZIJNEN & BOUWAANSLUITINGEN

Afdichtband VKP KOMO compriband

- Voegen dichten
- Slagregendicht
- Verticale buitengevelvlakken en binnenspouwblad
- **Damp open**

Art.nr. 0875 280 ...

Meest verkocht:

Band 3 mm / voeg 3 - 4 mm / 10 mm diep

Art.nr. 0875 280 004

Band 3 mm / voeg 3 - 4 mm / 15 mm diep

Art.nr. 0875 280 005

Band 4 mm / voeg 4 - 5 mm / 20 mm diep

Art.nr. 0875 280 008



Cert. nr. 33018



Maximale voegbreedte mm	Bandbreedte mm	Banddikte mm	Art.nr.
2-3	10	2	0875 280 001
2-3	15		0875 280 002
2-3	20		0875 280 003
3-4	10	3	0875 280 004
3-4	15		0875 280 005
4-5	10	4	0875 280 006
4-5	15		0875 280 007
4-5	20		0875 280 008
5-7	15	6	0875 280 009
5-7	20		0875 280 010
5-7	30		0875 280 011
6-10	20	8	0875 280 012
8-12	20	10	0875 280 013
8-12	25		0875 280 014

EURASOL® Butylband Flex

- Zeer flexibele afdichtband
- Lucht-, wind- en waterdichte afdichtingen voor zowel **binnen als buiten**
- 20 meter op rol

50 mm breed

Art.nr. 0875 635 050

80 mm breed

Art.nr. 0875 635 080



LUCHTDICHT BOUWEN RAAM- EN DEURKOZIJNEN & BOUWAANSLUITINGEN

Afdichtband VKP trio / compriband

- Buitenkant van kozijn (koude zijde) slagregendicht en damp open
- Midden in het kozijn zorgt de opvulling voor warmte-isolatie
- Binnenkant van het kozijn (warme zijde) luchtdicht en dampremmend

Art.nr. 0875 34. ...



LUCHTDICHT BOUWEN **BINNENZIJD**E FOLIES



068100006 VE 75
WÜTOP® DS 100 dampdichte folie
DAMPDICHTFOLIE-DS100-L50M-B1,5M-75M2



0681000264 VE 150
WÜTOP® dampremmende folie DB 20
DAMPREM.FOLIE-DB20-L50M-B3M-150M2



0681150001 VE 100
Dampremmende folie PE 150
DAMPREM.-FOLIE-PE150-L50M-L50-B2M-100M2



0681150003 VE 150
Dampremmende folie PE 150
DAMPREM.-FOLIE-PE150-L50M-B3M-150M2



0818000101 VE 300
Afdek-/bouwfolie T100/T200
BOUWFOLIE-LDPE-T100-L50-B6M-300M2



0818000201 VE 300
Afdek-/bouwfolie T100/T200
BOUWFOLIE-LDPE-T200-L50-B6M-300M2



0818002200 VE 200
Afdek-/bouwfolie T100/T200
BOUWFOLIE-LDPE-T200-L50-B4M-200M2



0893700111 VE 1
Hechtmiddel ALL-IN-ONE
CONTACTLIJM-(ALL-IN-ONE)-310ML



0992700119 VE 18
Bevestigingstape voor dakbeschermfolie E...
EURADOP 19MM - DUBBELZIJDIGE TAPE



0681000147 VE 75
Vochtvariabele dampdoorlatende folie WÜ...
DAMPREM.FOLIE-(VARIO SD)-B1,5M-L50M-75M



0681000267 VE 75
WÜTOP® dampremmende folie DB 20
DAMPREM.FOLIE-DB20-L50M-B1,5M-75M2



0681150002 VE 130
Dampremmende folie PE 150
DAMPREM.-FOLIE-PE150-L50M-B2,6M-130M2



0818000091 VE 150
Gewapende dampremmende PE folie
DAMPREM.-FOLIE-GEWAPEND-L50MXB3M-150I



0818000199 VE 100
Afdek-/bouwfolie T100/T200
BOUWFOLIE-LDPE-T200-L50-B2M-100M2



0818002100 VE 200
Afdek-/bouwfolie T100/T200
BOUWFOLIE-LDPE-T100-L50-B4M-200M2



0818011090 VE 100
Gewapende dampremmende PE folie
DAMPREM.-FOLIE-GEWAPEND-L50MXB2M-100I



0992700050 VE 6
Kleefafdichtingstape EURASOL®
EURASOL TAPE 60MMX25M



0992710060 VE 6
Kleefafdichtingstape EURASOL® PLUS
AFDICHTTAPE-(EURASOL-PLUS)-60MM



LUCHTDICHT BOUWEN **BINNENZIJD**E FOLIES

WÜTOP® dampremmende folie DB 20

Gewapende dampremmende folie van 130 gr per m² met een sd-waarde van 20-25 meter. Voor toepassingen aan de binnenzijde (warme zijde) van vloer,- gevel of dakconstructies.

Art.nr. 0681 000 267 1,5 m
Art.nr. 0681 000 264 3 m



Dampremmende folie PE 150

Een dampremmende folie met een sd-waarde van ca. 58,5 meter die voldoet aan de minimale KOMO-eis van 150mu. Voor toepassingen aan de binnenzijde van de constructie zoals binnenwanden en zolderkappen

Art.nr. 0681 150 001 1,5 m
Art.nr. 0681 150 002 2,6 m
Art.nr. 0681 150 003 3 m



Variabele dampremmende folie WÜTOP® THERMO VARIO SD

Gewapende variabele dampremmende polyeste folie van 100 gr per m². Variabele SD-waarde van 0,18 tot 20 meter.

Ook verkrijgbaar met Brandclassificatie B-s1, d0, art.nr. 0681 000 024

Art.nr. 0681 000 147
Rolbreedte 1,5 m



WÜTOP® DS 100 dampdichte folie

Gewapende dampdichte folie met opgedampte aluminium toplaag van 156 gr per m² met een hoge sd-waarde van 158 meter.

- Voor toepassingen waar extra eisen aan dampdichtheid van de binnenconstructie wordt gesteld zoals bijv. badkamers of zwembaden.

Art.nr. 0681 000 006
Rolbreedte 1,5 m



LUCHTDICHT BOUWEN

DAK-, GEVEL- EN WANDFOLIES



0681001114 VE 75
WÜTOP® PP Plus 170 dak- en wandfolie
DAKFOLIE-WÜTOP-PP-PLUS-170-2KS



0681001015 VE 75
Wandfolie WÜTOP® 95
ONDERDAKFOLIE-WÜTOP95-L50-B1,5M-75M2



0681001037 VE 75
Dakfolie WÜTOP® Thermo ND Plus
ONDERDAKFOLIE WUTOP THERMO ND PLUS 2



0681001089 VE 150
Dakfolie WÜTOP® Thermo ND Plus
DAKFOLIE-THERMO-ND-PLUS-L50-B3M-150M2



0875851160 VE 5
PE nagelafdichtband EURASOL®
TENGËLBAND PE-3X60MM-30M



0992700050 VE 6
Kleefafdichtingstape EURASOL®
EURASOL TAPE 60MMX25M



0992710160 VE 6
Afdichtingstape EURASOL® MAX
EURASOL MAX TAPE - 60MM X 25M



0992710162 VE 2
Afdichtingstape EURASOL® MAX
EURASOL MAX TAPE 100MM X 25M



0992720100 VE 6
Afdichtingstape Eurisol® Thermo HT
EURASOL THERMO HT 100MM



0681001252 VE 75
WÜTOP ECONOMY dak- en wandfolie 150
DAK-WANDF.-WUTOP-ECONOMIC-2SK-1,5M-75M2



0681001251 VE 75
WÜTOP ECONOMY dak- en wandfolie 150
DAK-WANDFOLIE-WUTOP-ECONOMIC-1,5M-75M2



0681001253 VE 150
WÜTOP ECONOMY dak- en wandfolie 150
DAK-WANDFOLIE-WUTOP-ECONOMIC-3M-150M2



0875851145 VE 7
PE nagelafdichtband EURASOL®
TENGËLBAND PE-3X45MM-30M



0893700111 VE 1
Hechtmiddel ALL-IN-ONE
CONTACTLIJM-(ALL-IN-ONE)-310ML



0992700119 VE 18
Bevestigingstape voor dakbeschermfolie E...
EURADÖP 19MM - DUBBELZIJDIGE TAPE



0992710161 VE 2
Afdichtingstape EURASOL® MAX
EURASOL MAX TAPE 190MM X 25M



0992720060 VE 10
Afdichtingstape Eurisol® Thermo HT
EURASOL THERMO HT 60MM



0992750050 VE 6
Kleefafdichtingstape EURASOL® DUS
EURASOL DUS TAPE - 60MM X 25M



LUCHTDICHT BOUWEN

DAK-, GEVEL- EN WANDFOLIES

Wandfolie WÜTOP® 95

Economisch voordelige dampopen en waterkerende wandfolie van 95 gr per m² met een sd-waarde van 0,02 meter.

Art.nr. 0681 001 015

Rollbreedte 1,5 m

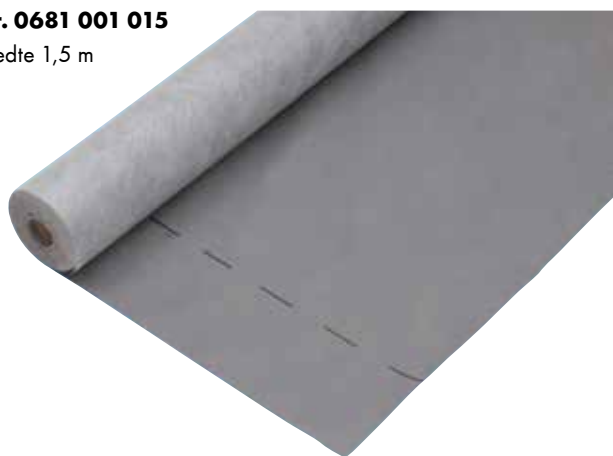

WÜTOP® Economy 150

dak- en wandfolie

3-laagse standaard damp-open/ waterkerende polypropeen dak- en wandfolie van 150 gram per m² met een sd-waarde van 0,03 meter.

Art.nr. 0681 001 251 1,5 m

Art.nr. 0681 001 253 3 m

Art.nr. 0681 001 252 1,5 m (KS)

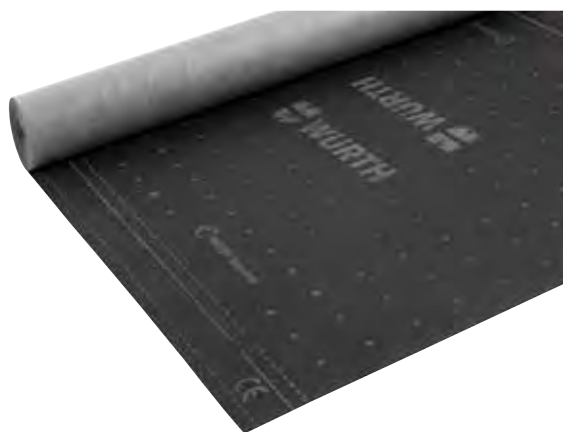

WÜTOP® PP Plus 170

dak- en wandfolie

Hoogwaardige, luchtdichte monolithische TPU dak- en wandfolie met brandklasse B

Art.nr. 0681 001 114 1,5 m (KS)



WÜTOP® THERMO ND

dak- en wandfolie

Geschikt voor toepassingen waarbij hoge temperaturen en/of condensbelasting plaats vindt, zoals onder zonnepaneelssystemen en zwarte dakpannen.

Art.nr. 0681 001 037 1,5 m

Art.nr. 0681 001 089 3 m

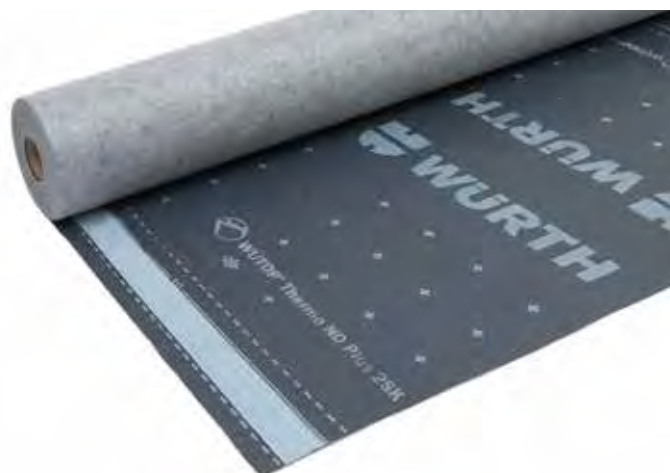

LUCHTDICHT BOUWEN

DAK-, GEVEL- EN WANDFOLIES



0681001107 VE 75
Microgeperforeerde folie WÜFOL 125WG
DAMPO-FOLIE-WÜFOL-125WG-B1,5MX50M-75M

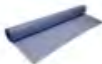

0681001109 VE 150
Microgeperforeerde folie WÜFOL 125WG
DAMPO-FOLIE-WÜFOL-125WG-B3MX50M-150M

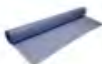

0681001232 VE 150
Gevelfolie WÜTOP® 200 B
GEVELFOLIE-(WÜTOP200-B)-B3-L50-150M2



0875851160 VE 5
PE nagelafdichtband EURASOL®
TENGEĻBAND PE-3X60MM-30M



0992700050 VE 6
Kleefafdichtingstape EURASOL®
EURASOL TAPE 60MMX25M



0992710161 VE 2
Afdichtingstape EURASOL® MAX
EURASOL MAX TAPE 190MM X 25M



0681001108 VE 100
Microgeperforeerde folie WÜFOL 125WG
DAMPO-FOLIE-WÜFOL-125WG-B2MX50M-100M

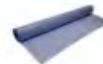

0681001230 VE 75
Gevelfolie WÜTOP® 200 B
GEVELFOLIE-(WÜTOP200-B)-B1,5-L50-75M2



0875851145 VE 7
PE nagelafdichtband EURASOL®
TENGEĻBAND PE-3X45MM-30M



0893700111 VE 1
Hechtmiddel ALL-IN-ONE
CONTACTLIJM-(ALL-IN-ONE)-310ML



0992710160 VE 6
Afdichtingstape EURASOL® MAX
EURASOL MAX TAPE - 60MM X 25M



0992710162 VE 2
Afdichtingstape EURASOL® MAX
EURASOL MAX TAPE 100MM X 25M



LUCHTDICHT BOUWEN

DAK-, GEVEL- EN WANDFOLIES

Gevelfolie WÜTOP® 200 B

Dankzij het PES-vliesweefsel en de innovatieve, damp-open polyurethaancoating heeft de WÜTOP® 200 B duurzame UVbescherming en een hoge brandwerendheid.

Art.nr. 0681 001 230 1,5 m
Art.nr. 0681 001 232 3 m



Gevelfolie Stamisol Safe One

Gevelfolie met brandklasse A2 voor gevels met decoratieve voegen, een open verbindingsgedeelte van maximaal 50% van het geveloppervlak en vrije voegbreedtes van maximaal 50 mm.

Art.nr. 0681 001 199 2,65 m

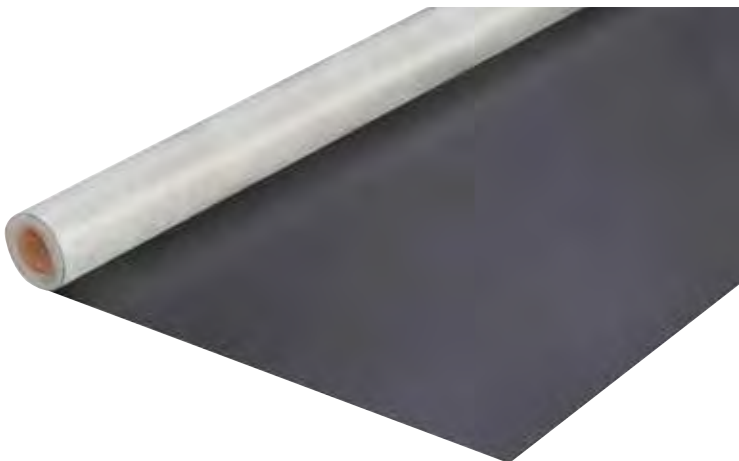

Microgeperforeerde folie WÜFOL 125WG

Drielaags gewapende microgeperforeerde PE folie van circa 140 gram per m². De folie is beperkt waterkerend en dampdoorlatend en wordt hoofdzakelijk toegepast als tijdelijke afdichting van openingen tegen wind en water op de bouw. Daarnaast kan de folie ook worden toegepast als waterkering aan de buitenzijde van de constructie bij dichte gevel- en wandelementen.

Art.nr. 0681 001 107 1,5 m
Art.nr. 0681 001 108 2 m
Art.nr. 0681 001 109 3 m



LUCHT- & WINDDICHT

Er zijn verschillende soorten producten nodig om een gebouw op een juiste manier "Lucht- & Winddicht" op te leveren. Denk hierbij aan kisten, flexibele PU-schuimen, coatings, banden, folies en tapes. Omdat er een tal van producten verkrijgbaar zijn in de markt snappen wij dat het wel eens onduidelijk kan zijn wanneer welk product toe te passen. Om u hierbij te ondersteunen hebben wij een Foliewijzer ontwikkeld waarbij u na een aantal vragen te beantwoorden bij de juiste folie uitkomt.



*Voor meer informatie
scan de QR-code*

TOEBEHOREN

Kleefafdichtingstape Eurasol®

Art.nr. 0992 700 050
VE/st. 6



Kleefafdichtingstape Eurasol® Max

60 mm Art.nr. 0992 710 160 VE/st. 6
190 mm Art.nr. 0992 710 161 VE/st. 2
100 mm Art.nr. 0992 710 162 VE/st. 2



Afdichtingstape Eurasol® Thermo HT

60 mm Art.nr. 0992 720 060 VE/st. 10
100 mm Art.nr. 0992 720 100 VE/st. 6
150 mm Art.nr. 0992 720 150 VE/st. 4



Eurasol® tengelband

45 mm Art.nr. 0875 851 145 VE/st. 7
60 mm Art.nr. 0875 851 160 VE/st. 5



Euradop® zelfklevende afdichtingstape Dubbelzijdige tape voor het duurzaam verlijmen in binnen- en buitenbereik

Art.nr. 0992 700 119
VE/st. 6



Eurasol® DUS kleefafdichtingstape Speciale kleefband voor winddichte kleefverbindingen van onderdakfolies

Art.nr. 0992 750 050
VE/st. 6



Lucht- en winddichte manchet Wütop® Verkrijgbaar in standaard en thermo uitvoering

Art.nr. 0681 000 2..
VE/st. 10



All-in-One verbindingslijm Ecoline 310 ml Voor het permanent afdichten van alle verbindingsnaden om ervoor te zorgen dat ze lucht- en winddicht zijn

Art.nr. 0893 700 111
VE/st. 1



LUCHTDICHT BOUWEN **WATERKERING**

Loodvervanger **WÜTOP® FORMFLEX**

Art.nr. 0681 018 08.



Loodvervanger **WÜTOP® FORMFLASH**

Art.nr. 0681 018 07.



DPC folie

Art.nr. 0681 002 01.



EPDM-folie exterieur

Art.nr. 0875 350 ...

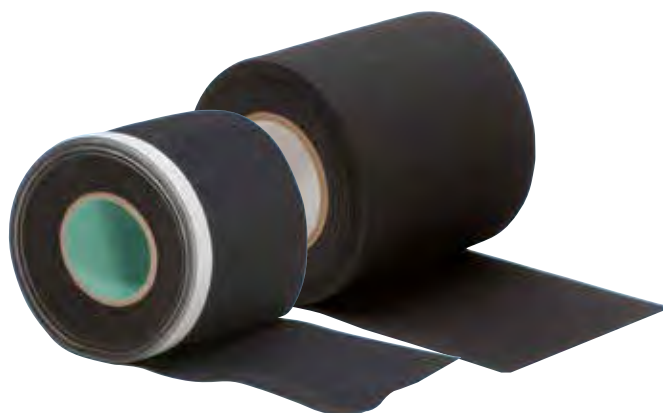

LUCHTDICHT BOUWEN WATERKERING

 0681002015 VE 1 DPC folie FOLIE-DPC-L50MXB150MM-7,5M2	
 0681002030 VE 1 DPC folie FOLIE-DPC-L50MXB300MM-15M2	
 0681002060 VE 1 DPC folie FOLIE-DPC-L50MXB600MM-30M2	
 0681018073 VE 5 Loodervanger WÜTOP® FormFlash LOODVERV-WUTOP-FORMFLASH-B150M-L5M	
 0681018075 VE 5 Loodervanger WÜTOP® FormFlash LOODVERV-WUTOP-FORMFLASH-B250M-L5M	
 0681018077 VE 5 Loodervanger WÜTOP® FormFlash LOODVERV-WUTOP-FORMFLASH-B400M-L5M	
 0681018080 VE 5 Loodervanger WÜTOP® FormFlex LOODVERV-FORMFLEX-ZWART-B150MM-5M	
 0681018082 VE 5 Loodervanger WÜTOP® FormFlex LOODVERV-FORMFLEX-ZWART-B300MM-5M	
 0681018086 VE 5 Loodervanger WÜTOP® FormFlex LOODVERV-FORMFLEX-GRIJS-B300MM-5M	
 0875350150 VE 6 EPDM afdichtband Buiten EPDM FOLIE-BUITEN-0,6X150MMX20M	
 0875350152 VE 6 EPDM butylafdichtingstape voor buiten DIBA-RAL-BUITEN-EPDM/BUT-1,2X150MMX20M	

 0681002020 VE 1 DPC folie FOLIE-DPC-L50MXB200MM-10M2	
 0681002040 VE 1 DPC folie FOLIE-DPC-L50MXB400MM-20M2	
 0681002101 VE 1 DPC folie FOLIE-DPC-L50MXB1000MM-50M2	
 0681018074 VE 5 Loodervanger WÜTOP® FormFlash LOODVERV-WUTOP-FORMFLASH-B200M-L5M	
 0681018076 VE 5 Loodervanger WÜTOP® FormFlash LOODVERV-WUTOP-FORMFLASH-B300M-L5M	
 0681018078 VE 5 Loodervanger WÜTOP® FormFlash LOODVERV-WUTOP-FORMFLASH-B500M-L5M	
 0681018081 VE 5 Loodervanger WÜTOP® FormFlex LOODVERV-FORMFLEX-ZWART-B200MM-5M	
 0681018083 VE 15 Loodervanger WÜTOP® FormFlex LOODVERV-FORMFLEX-ZWART-B300MM-15M	
 0681018087 VE 5 Loodervanger WÜTOP® FormFlex LOODVERV-FORMFLEX-ROOD-B300MM-5M	
 0875350151 VE 6 EPDM afdichtband Buiten DIBA-RAL-BUITEN-EPDM-SK-0,6X150MMX20M	
 0875350153 VE 6 EPDM afdichtband Binnenshuis, butyl DIBA-RAL-BINNEN-EPDM/BUT-1,2X150MMX20M	

LUCHTDICHT BOUWEN WATERKERING

<p>0875350200 VE 4 EPDM afdichtband Buiten EPDM FOLIE-BUITEN-0,6X200MMX20M</p>	
<p>0875350202 VE 4 EPDM butylafdichtingstape voor buiten DIBA-RAL-BUITEN-EPDM/BUT-1,2X200MMX20M</p>	
<p>0875350250 VE 4 EPDM afdichtband Buiten EPDM FOLIE-BUITEN-0,6X250MMX20M</p>	
<p>0875350252 VE 4 EPDM butylafdichtingstape voor buiten DIBA-RAL-BUITEN-EPDM/BUT-1,2X250MMX20M</p>	
<p>0875350300 VE 3 EPDM afdichtband Buiten EPDM FOLIE-BUITEN-0,6X300MMX20M</p>	
<p>0875350302 VE 3 EPDM butylafdichtingstape voor buiten DIBA-RAL-BUITEN-EPDM/BUT-1,2X300MMX20M</p>	
<p>0875350400 VE 2 EPDM afdichtband Buiten EPDM FOLIE-BUITEN-0,6X400MMX20M</p>	
<p>0875350402 VE 2 EPDM butylafdichtingstape voor buiten DIBA-RAL-BUITEN-EPDM/BUT-1,2X400MMX20M</p>	
<p>0875350500 VE 2 EPDM afdichtband Buiten EPDM FOLIE-BUITEN-0,6X500MMX20M</p>	
<p>0875350502 VE 2 EPDM butylafdichtingstape voor buiten DIBA-RAL-BUITEN-EPDM/BUT-1,2X500MMX20M</p>	

<p>0875350201 VE 4 EPDM afdichtband Buiten DIBA-RAL-BUITEN-EPDM-SK-0,6X200MMX20M</p>	
<p>0875350203 VE 4 EPDM afdichtband Binnenshuis, butyl DIBA-RAL-BINNEN-EPDM/BUT-1,2X200MMX20M</p>	
<p>0875350251 VE 4 EPDM afdichtband Buiten DIBA-RAL-BUITEN-EPDM-SK-0,6X250X20M</p>	
<p>0875350253 VE 4 EPDM afdichtband Binnenshuis, butyl DIBA-RAL-BINNEN-EPDM/BUT-1,2X250MMX20M</p>	
<p>0875350301 VE 3 EPDM afdichtband Buiten DIBA-RAL-BUITEN-EPDM-SK-0,6X300MMX20M</p>	
<p>0875350303 VE 3 EPDM afdichtband Binnenshuis, butyl DIBA-RAL-BINNEN-EPDM/BUT-1,2X300MMX20M</p>	
<p>0875350401 VE 2 EPDM afdichtband Buiten DIBA-RAL-BUITEN-EPDM-SK-0,6X400MMX20M</p>	
<p>0875350403 VE 2 EPDM afdichtband Binnenshuis, butyl DIBA-RAL-BINNEN-EPDM/BUT-1,2X400MMX20M</p>	
<p>0875350501 VE 2 EPDM afdichtband Buiten DIBA-RAL-BUITEN-EPDM-0,6XSK-500MMX20M</p>	
<p>0875350503 VE 2 EPDM afdichtband Binnenshuis, butyl DIBA-RAL-BINNEN-EPDM/BUT-1,2X500MMX20M</p>	

BRANDWERENDE SYSTEMEN

Scan de QR-code
voor meer informatie



De kans op een snelle uitbreiding van brand moet voldoende worden beperkt om een eventuele brand in een gebouw beheersbaar te kunnen houden. Met het woord 'snelle' is tot uitdrukking gebracht dat de uitbreiding van brand, door de aangebrachte brandscheidingen zodanig moet worden vertraagd dat veilig vluchten mogelijk is (Bouwbesluit 2012 afdeling 2.10).

Zowel voor utiliteitsgebouwen, zoals kantoren, als woongebouwen geeft het Bouwbesluit eisen voor veiligheid. De eisen voor de brandwerendheid van hoofdconstructies van utiliteitsgebouwen zijn afhankelijk van gebruiksfunctie en ge-

bouwhoogte. Voor kantoren en andere 'niet-slaapgebouwen' (bijvoorbeeld bedrijfsgebouwen, scholen en winkels) liggen de eisen lager dan voor 'slaapgebouwen' (waaronder hotels, ziekenhuizen, flatgebouwen en gevangenissen). Hoe hoger het gebouw, hoe hoger de eisen. De eisen gaan steeds met 30 minuten omhoog bij de 5 en 13 m hoogtegrens.

Würth heeft verschillende brandwerende systemen in het programma voor de meest voorkomende doorvoersituaties om eventuele brand in gebouwen te kunnen vertragen, beheersen en daarmee levens te kunnen redden. Alle brandwerende systemen zijn voorzien van Europese goedkeuringen (ETA).

BRANDWERENDE SYSTEMEN

Brandwerende acrylaat ACR 240

Voor het brandwerend afdichten van lineaire voegen in massieve wanden/vloeren en lichte scheidingswanden

Art.nr. 0893 311 000

ETA 21-0085



ETA 21-0084



Brandwerende PU schuim EI 240

Afdichting van verticale en horizontale voegen in massieve wanden (dikte boven 150 mm) volgens ETA-21/0517

Brandwerendheidsklasse tot EI 180
Voegbreedte tot 30 mm

Art.nr. 0893 303 410

ETA-21_0517



Brandwerende combi schuim

Brandwerende combi schuim
Art.nr. 0893 303 200

ETA-11/0528



Applicatie pistool EM
Art.nr. 0893 303 206

Mixer
Art.nr. 0893 303 152



Brandwerende mineraalplaat AB

Art.nr. 0893 308 4 60 mm
Art.nr. 0893 308 5 50 mm

ETA-15/0294

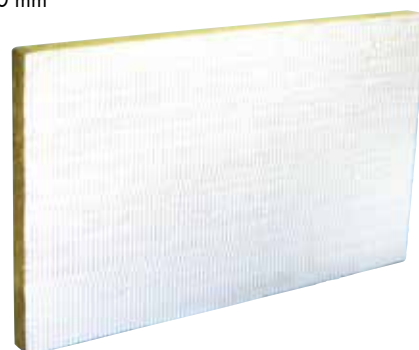

Meer info
vraag de brochure
Brandwerende Systemen aan bij
uw vertegenwoordiger

www.wurth.nl/brandwerend



LADDERS EN TRAPPEN

Würth multi ladder

Verkrijgbaar in 3, 4 en 5 treden

Art.nr. 0962 941 40.



Plateau voor multi ladder

Art.nr. 0962 941 620



WÜRTH PERIODIEKE KEURINGEN VAN UW LADDERS EN TRAPPEN DOOR EEN GESPECIALISEERD KEURBEDRIJF!

Rechtstreeks contact:

Würth Service Center
Telefoon +31 (0)73 629 1600
E-mail keuringen@wurth.nl

Bordestrap

Verkrijgbaar met 3 t/m 10 treden

Art.nr. 0962 941 0..



Würth dubbele trap

Verkrijgbaar met 2x2 t/m 2x12 treden

Art.nr. 0962 941 1..



Ladder

Verkrijgbaar met 10, 12, 14, 16 sporten

Art.nr. 0962 941 24.



Bekijk hier de Würth Ladders & Trappen brochure



VALBEVEILIGING

Veiligheidsharnas

Basis

Art.nr. 0899 032 911



Ook andere modellen verkrijgbaar

Art.nr. 0899 032 ...



Rugzak voor persoonlijke beschermingsmiddelen

- Groot vak
- Opbergnet voor helm
- Zakjes voor GSM en drinkfles

Art.nr. 0899 032 943



Y-verbinding

- 1,5 meter
- Grote karabijnhaken
- Eenvoudige en snelle bevestiging aan buizen met max. Ø 59 mm
- Voor wisselende werkposities

Art.nr. 0899 032 015



Valbeveiliging meelopend W101

- Met geïntegreerde valdemper
- Loopt vrij mee in de klimrichting en vergrendelt automatisch bij een val
- Robuust, flexibel 11-mm kernmanteltouw
- Getest en toegelaten tot 140 kg

Art.nr. 0899 032 929



Enkele lijn

- 1,5 meter
- Grote karabijnhaak
- Eenvoudige en snelle bevestiging aan buizen met max. Ø 59 mm
- Ideaal voor steigerbouwers

Art.nr. 0899 032 014



Valbeveiligingsapparaat Pro met staalkabel

Biedt optimale bewegingsvrijheid en flexibiliteit tijdens het werk en zorgt gelijktijdig voor maximale veiligheid bij een eventuele val

Art.nr. 0899 032 115



WÜRTH BARCODE VALBEVEILIGING

 4 0 6 5 7 4 6 4 6 9 0 0 5
0899032844 VE 1
 Valbeveiliging, W102 Met riemband
 VALSTOPAPP MET GORDEL-W102-L2,5M



 4 0 4 5 9 8 9 0 5 9 2 9 4
0899032005 VE 1
 Steigerbouw valbeveiliger, set
 STEIGERBOUWSET VALBEVEILIGING





 4 0 4 5 7 2 7 4 3 4 3 7 6
0899032014 VE 1
 Verbindingsstuk met bandvaldemper en ste...
 VERB. MIDDEL-VALDEMPER-(BUISHAAK)-1,5M





 4 0 9 9 6 1 8 0 0 3 8 1 3
0899032150 VE 1
 Valbeveiligingsset Compact, 4-delig
 VALBEVEILIGINGSSET-COMPACT



 4 0 3 8 8 9 8 3 8 5 3 3 0
0899032911 VE 1
 Veiligheidsharnas Basis
 VALBEVEILIGINGSHARNAS BASIS



 4 0 2 4 8 3 5 9 8 1 7 6 7
0899032916 VE 1
 Bandlus
 BANDLUS VALBEVEILIGING 1,5 M





 4 0 4 7 3 7 6 8 1 9 5 0 4
0899032943 VE 1
 Rugzak
 RUGZAK T.B.V. VALBEVEILIGING



 4 0 6 5 7 4 6 4 1 6 0 7 8
0899032103 VE 1
 Valbeveiligingsset Elastico W1003 3-delig
 VALBEVEILIGINGSSET-W1003-3DELIG



 4 0 4 5 9 8 9 2 4 3 9 1 4
0899032015 VE 1
 Y-verbinding
 Y-VERBINDINGSMIDDEL, KARABIJN GROOT-1,5



 4 0 6 2 8 5 6 0 9 6 9 4 7
0899032929 VE 1
 Opvangsysteem, meelopend W101
 MEELOPEND-OPVANGAPP-W101-15MTR-140K



 4 0 4 5 9 8 9 4 0 6 3 0 2
0899032922 VE 1
 Bandlus
 BANDLUS-EN354/795-80CMX25MM



 4 0 4 5 9 8 9 3 7 2 2 2 5
0899032960 VE 1
 Tijdelijk horizontaal valbeveiligingssys...
 HORIZONTAAL BEVEILIGINGSSYSTEEM



 4 0 6 5 7 4 6 3 3 6 7 4 1
0899032094 VE 1
 D-ring verlengstuk
 D-RING-VERLENGING-VALBEVEILIGING-L0,5M



VALBEVEILIGING

Bandlus

- 1,5 meter, geel

Art.nr. 0899 032 916



Bandlus

- 0,8 meter
- Zwart

Art.nr. 0899 032 922



Tijdelijk horizontaal bevestigingssysteem

- Gordel met ratel
- 20 meter lang
- Draaikarabijnen en 2 bandlussen
- In draagtas

Art.nr. 0899 032 960



Valbeveiligingsset Compact, 4-delig

Complete set met veiligheidsharnas, valstopapparaat, geweven bandlus en rugzak.

Art.nr. 0899 032 150



Valbeveiligingsset Elastico W1003 3-delig

Complete set met veiligheidsharnas, synchroon meelopende valbeveiliging met 15 meter touw en opbergkoffer. Getest en toegelaten tot 140 kg.

Art.nr. 0899 032 103



WÜRTH BARCODE HANDSCHOENEN

<p>0899400 VE 12 Beschermende handschoen, leder, andere WERKHANDSCH SPLITLEDER GR.10,5</p>	
<p>0899400480 VE 12 Beschermende handschoen, nitril, Maxifle... MONTAGEHANDSCHOEN MAXIFLEX MT 7</p>	
<p>0899400482 VE 12 Beschermende handschoen, nitril, Maxifle... MONTAGEHANDSCHOEN MAXIFLEX MT 9</p>	
<p>0899400484 VE 12 Beschermende handschoen, nitril, Maxifle... MONTAGEHANDSCHOEN MAXIFLEX MT 11</p>	
<p>0899400870 VE 12 Werkhandschoen groen/geel met latex coat... WERKHANDSCHOEN GROEN/GEEL MT 10</p>	
<p>0899404028 VE 6 Beschermende handschoen Tigerflex Thermo... HANDSCH-WINTER-TIGERFLEX-THERMO-MT8</p>	
<p>0899404030 VE 6 Beschermende handschoen Tigerflex Thermo... HANDSCH-WINTER-TIGERFLEX-THERMO-MT10</p>	
<p>0899411018 VE 12 Tigerflex Plus beschermende nitrilhandsc... TIGERFLEX PLUS MONTAGEHANDSCHOEN, MT</p>	
<p>0899411020 VE 12 Tigerflex Plus beschermende nitrilhandsc... TIGERFLEX PLUS MONTAGEHANDSCHOEN, MT</p>	
<p>0899401158 VE 6 Montagehandschoen PU, zwart HANDSCHOEN-PU-FLEX-BLACK-MT 8</p>	
<p>0899401161 VE 6 Montagehandschoen PU, zwart HANDSCHOEN-PU-FLEX-BLACK-MT 11</p>	

<p>0899400481 VE 12 Beschermende handschoen, nitril, Maxifle... MONTAGEHANDSCHOEN MAXIFLEX MT 8</p>	
<p>0899400483 VE 12 Beschermende handschoen, nitril, Maxifle... MONTAGEHANDSCHOEN MAXIFLEX MT 10</p>	
<p>0899400869 VE 12 Werkhandschoen groen/geel met latex coat... WERKHANDSCHOEN GROEN/GEEL MT 9</p>	
<p>0899400871 VE 12 Werkhandschoen groen/geel met latex coat... GROEN GELE HANDSCHOEN -EN420- MT11</p>	
<p>0899404029 VE 6 Beschermende handschoen Tigerflex Thermo... HANDSCH-WINTER-TIGERFLEX-THERMO-MT9</p>	
<p>0899404031 VE 6 Beschermende handschoen Tigerflex Thermo... HANDSCH-WINTER-TIGERFLEX-THERMO-MT11</p>	
<p>0899411019 VE 12 Tigerflex Plus beschermende nitrilhandsc... TIGERFLEX PLUS MONTAGEHANDSCHOEN, MT</p>	
<p>0899411021 VE 12 Tigerflex Plus beschermende nitrilhandsc... TIGERFLEX MONTAGEHANDSCHOEN PLUS, MT</p>	
<p>0899401159 VE 6 Montagehandschoen PU, zwart HANDSCHOEN-PU-FLEX-BLACK-MT 9</p>	
<p>0899401160 VE 6 Montagehandschoen PU, zwart HANDSCHOEN-PU-FLEX-BLACK-MT 10</p>	

HANDSCHOENEN

Werkhandschoenen

- Gebreide handschoen met latex
- Veel grip
- Natte en droge omstandigheden

Art.nr. 0899 400 870 Maat 20
(andere maten - zie barcodeblad)

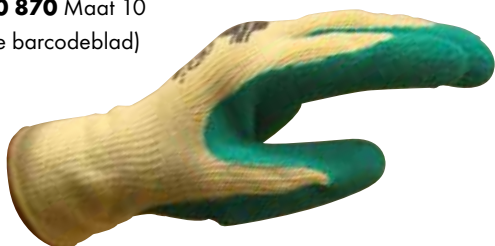

Montagehandschoen PU

Extreem lichte en flexibele handschoen met superieure beweeglijkheid en gevoel in de vingertoppen

- Comfortabele, lichte montagehandschoen
- Naadloos rondgebreid 100% nylon stof
- Siliconenvrij fabricageproces
- PU-coating
- Uitstekende flexibiliteit
- Uitstekende pasvorm
- Zeer comfortabel
- Elastische manchetten



Art.nr. 0899 401 159 Maat 9
(andere maten - zie barcodeblad)

Varkenslederen handschoenen

Art.nr. 0899 400 Maat 10,5
(1 maat)



Splitlederen handschoenen

Art.nr.
5350 000 109 maat 9
5350 000 110 maat 10



TIGER-FLEX PLUS handschoenen

- Huidvriendelijke, naadloze, rondgebreide nylon, lycra® draagweefsel
- Nitrilschuim coating van het handoppervlak met extra nitril "Tiger" grip
- Ademend, hoog draagcomfort
- Elastische band

Art.nr. 0899 411 020

Maat 10
(andere maten -
zie barcodeblad)



MAXI-FLEX handschoenen

- Nylon/nitril met mikro schuim
- Zeer goede pasvorm
- Geen zweethanden
- Zeer goede vingergevoeligheid

Art.nr. 0899 400 483 Maat 10

(andere maten -
zie barcodeblad)



TIGER-FLEX THERMO handschoenen

Art.nr. 0899 404 030 Maat 10

(andere maten - zie barcodeblad)



WÜRTH BARCODE HANDSCHOENEN

<p>0899400529 VE 6 Monteurshandschoen MONTAGEHANDSCHOEN MAAT 8</p> <p>MT 8</p>	<p>0899400530 VE 6 Monteurshandschoen MONTAGEHANDSCHOEN MAAT 9</p> <p>MT 9</p>
<p>0899400531 VE 6 Monteurshandschoen MONTAGEHANDSCHOEN MAAT 10</p> <p>MT 10</p>	<p>0899400532 VE 6 Monteurshandschoen MONTAGEHANDSCHOEN MAAT 11</p> <p>MT 11</p>
<p>0899401048 VE 12 Beschermende handschoen Nitril Tigerflex... MONTHANDSCHOEN-NTR-(TIGERFLEX-COOL)-MT8</p> <p>MT 8</p>	<p>0899401049 VE 12 Beschermende handschoen Nitril Tigerflex... MONTHANDSCHOEN-NTR-(TIGERFLEX-COOL)-MT9</p> <p>MT 9</p>
<p>0899401050 VE 12 Beschermende handschoen Nitril Tigerflex... MONTHANDSCHOEN-NTR-(TIGERFLEX-COOL)-MT10</p> <p>MT 10</p>	<p>0899401051 VE 12 Beschermende handschoen Nitril Tigerflex... MONTHANDSCHOEN-NTR-(TIGERFLEX-COOL)-MT11</p> <p>MT 11</p>
<p>089943509 VE 6 Chemisch bestendige handschoen van nitril... UNIVERSE HANDSCHOEN CHEMICALIEN GR 9</p> <p>MT 9</p>	<p>089943510 VE 6 Chemisch bestendige handschoen van nitril... CHEMICALIEN HANDSCHOEN NITRIL S10 KAT.3</p> <p>MT 10</p>
<p>0899451358 VE 6 Snijbestendige handschoen, TigerFlex W-2... SNIJBEST-HANDSCH-TIGERFLEX W230-C-MT 8</p> <p>MT 8</p>	<p>0899451359 VE 6 Snijbestendige handschoen, TigerFlex W-2... SNIJBEST-HANDSCH-TIGERFLEX W230-C-MT 9</p> <p>MT 9</p>
<p>0899451360 VE 6 Snijbestendige handschoen, TigerFlex W-2... SNIJBEST-HANDSCH-TIGERFLEX W230-C-MT 10</p> <p>MT 10</p>	<p>0899451361 VE 6 Snijbestendige handschoen, TigerFlex W-2... SNIJBEST-HANDSCH-TIGERFLEX W230-C-MT 11</p> <p>MT 11</p>
<p>0899403628 VE 3 Snijbestendige veiligheidshandschoenen W... SNIJBEST. HANDSCHOEN-W210-IMPACT-MT 8</p> <p>MT 8</p>	<p>0899403629 VE 3 Snijbestendige veiligheidshandschoenen W... SNIJBEST. HANDSCHOEN-W210-IMPACT-MT 9</p> <p>MT 9</p>
<p>0899403630 VE 3 Snijbestendige veiligheidshandschoenen W... SNIJBEST. HANDSCHOEN-W210-IMPACT-MT 10</p> <p>MT 10</p>	<p>0899403631 VE 3 Snijbestendige veiligheidshandschoenen W... SNIJBEST. HANDSCHOEN-W210-IMPACT-MT 11</p> <p>MT 11</p>
<p>0899899023 VE 3 Handschoenenclip met karabijnhaken HANDSCHOENCLIP MET KARABIJN-SET 3ST</p>	<p>Handschoenenclip met karabijnhaken Set van 3 stuks. Voor eenvoudige bevestiging aan werkkleding</p>

Handschoenenclip met karabijnhaken

Set van 3 stuks. Voor eenvoudige bevestiging aan werkkleding

Art.nr. 0899 899 023

VE/stuk 3



HANDSCHOENEN

Montagehandschoenen

- Nylon met latexafwerking
- Ademende handrug
- Uitstekende grip

Art.nr. 0899 400 531 Maat 10
(andere maten - zie barcodeblad)



TIGERFLEX W-230 niveau C snijbestendige handschoen

- Zeer slijtvast en snijbestendig
- Uitstekende snijbescherming door HPPE-vezels in combinatie met glasvezels (13 gauge)
- Nitrilschuim coating van het handoppervlak met extra nitril "Tiger" grip
- Ademend, hoog draagcomfort
- Goede grip bij droge en natte omstandigheden
- Goede pasvorm en flexibiliteit
- Elastische band

Art.nr. 0899 451 360 Maat 10
(andere maten - zie barcodeblad)



Snijbestendige veiligheidshandschoen W-210, impactniveau C

Universele snijbestendige veiligheidshandschoen voor werkzaamheden met een verhoogd risico op verbrijzeling, beknelling en snijwonden

Maat: 8 t/m 11

Art.nr. 0899 403 6..



Chemisch bestendige handschoen van nitril

- 100% ondoorlatend
- Stevige grip dankzij ruitpatroon
- Bescherming tegen een groot aantal chemicaliën en vloeistoffen zoals alkaliën, zuren, vetten, oliën en in sommige gevallen oplosmiddelen
- Siliconenvrij fabricageproces
- Getest op voedsel

Art.nr. 0899 435 10 Maat 10
(andere maten - zie barcodeblad)



TIGER-FLEX COOL handschoenen

- Huidvriendelijk, naadloos rondgebreid nylon/Lycra®-basisstof (diktemaat 13)
- Nitrilschuim-coating op handpalmen met extra nitril, Tiger Grip
- Comfortabel
- Uitstekende grip en beweeglijkheid
- Elastische manchetten
- Kleur van grippatroon: grijs

Art.nr. 0899 401 050 Maat 10
(andere maten - zie barcodeblad)



WÜRTH BARCODE OORDOPJES & VEILIGHEIDSRILLEN

<p>0899102393 VE 1 Veiligheidsbril Nashira VLGHDSBRIL-NASHIRA-HELDER</p>		<p>0899102271 VE 1 LIBRA ® veiligheidsbril VEILIGHEIDSRIL LIBRA GEKLEURD</p>	
<p>0899102395 VE 1 Veiligheidsbril Nashira VLGHDSBRIL-NASHIRA-GRIJS</p>		<p>0899102250 VE 1 Veiligheidsbril CEPHEUS ® BESCHERMBRIL CEPHEUS CLEAR</p>	
<p>0899102394 VE 1 Veiligheidsbril Nashira VLGHDSBRIL-NASHIRA-GEEL</p>		<p>0899102310 VE 1 Veiligheidsbril, UB ONE SAFEGLS-PC-EN170-(UB-ONE)-CLEAR</p>	
<p>0899102320 VE 1 Veiligheidsbril Cetus VEILIGHEIDSRIL CETUS TRANSPARANT</p>		<p>0899102350 VE 1 Briletui ETUI VOOR VEILIGHEIDSRIL</p>	
<p>0899300331 VE 200 Oordoppen x-100 GEOHOORDOPJES X-100 VE (200 PAAR)</p>		<p>0899300334 VE 200 Oordoppen x-200 GEOHOORDOPJES X-200 VE (200 PAAR)</p>	
<p>0899300335 VE 1 Dispenser voor oordoppen DISPENSER VOOR GEOHOORDOPJES X-100</p>		<p>0899300362 VE 300 Oordoppen x-100 OORDOPPEN-X100-NAVULVERPAKKING</p>	
<p>0899300363 VE 300 Oordoppen x-200 OORDOPPEN-X200-NAVULVERPAKKING</p>		<p>0899300338 VE 4 Oordoppen met koord OORDOPJES MET LAMELLEN EN KOORDJE</p>	

Bril Askella

Sportief en lichtgewicht model

Art.nr. 0899 103 170



Nu ook verkrijgbaar met op sterkte geslepen veiligheidsbrillen voor leescorrectie



Met leescorrectie 1,5 mm
Art.nr. 0899 103 160

Met leescorrectie 2,0 mm
Art.nr. 0899 103 161

Met leescorrectie 2,5 mm
Art.nr. 0899 103 162

OORDOPJES & VEILIGHEIDSRILLEN

Oordoppen X-100

- Standaard
- - 37 dB



Art.nr. 0899 300 331

Per 2 st. in zakje, 200 p/ds

Oordoppen X-200

- Slank
- Dun model
- - 33 dB



Art.nr. 0899 300 334

Per 2 st. in zakje, 200 p/ds

Oordoppen met koord

Art.nr. 0899 300 338



Dispenser oordoppen

Leeg

Art.nr. 0899 300 335

Navulling losse doppen

X-100

Art.nr. 0899 300 336

X-200

Art.nr. 0899 300 337

VE/st. 200



Veiligheidsbril CETUS

Standaard

Helder

Art.nr. 0899 102 320



Beugelbril CEPHEUS

Helder

Art.nr. 0899 102 250



Veiligheidsbril Nashira

Perfekte bescherming in een sportief, dynamisch ontwerp. Optimaal zicht en perfecte pasvorm.

Helder

Art.nr. 0899 102 393

Grijs

Art.nr. 0899 102 395

Geel

Art.nr. 0899 102 394



Veiligheidsbril UB ONE

Basic

- Gunstig geprijsd

Helder

Art.nr. 0899 102 310



Brillenreinigingsdoekjes doos 100 st.

Art.nr. 0899 102 303

VE/st. 100



Overzetbril, veiligheidsbril LIBRA

Premium

- Ook geschikt voor groot montuur

Art.nr. 0899 102 275

































Etui

Art.nr. 0899 102 350



WÜRTH BARCODE

STOFMASKERS, HELMEN & OORKAPPEN

 4 0 5 3 4 7 9 6 1 1 9 5 2 0899110500 VE 20 Bekervormig masker CM 3000 FFP1 NR D STOFMASKER=CM3000-FFP1-NR-D		 4 0 5 3 4 7 9 6 1 1 9 4 5 0899110501 VE 15 Bekervormig masker CM 3000 V FFP1 NR D STOFMASKER-CM300-VENTIEL-FFP1-NR-D	
 4 0 5 3 4 7 9 6 1 2 0 0 3 0899110502 VE 20 Bekervormig masker CM 3000 FFP2 NR D STOFMASKER-CM3000-FFP2-NR-D		 4 0 5 3 4 7 9 6 1 2 0 1 0 0899110503 VE 15 Bekervormig masker CM 3000 V FFP2 NR D STOFMASKER-CM3000-VENTIEL-FFP2-NR-D	
 4 0 5 3 4 7 9 6 1 2 0 4 1 0899110505 VE 5 Bekervormig masker CM 3000 V FFP3 NR D STOFMASKER-CM3000-VENT-FFP3-NR-D		 4 0 5 3 4 7 9 6 1 2 0 3 4 0899110504 VE 15 Bekervormig masker CM 3000, carbon V FFP... STOFMASKER-CM3000-VENTIEL-FFP2-CARBON	
 4 0 4 5 9 8 9 4 7 3 2 9 8 0899200250 VE 1 Helm Pro-Tek 6-punts VEILIGHEIDSHELM PRO TEK PRO ROOD		 4 0 4 5 9 8 9 4 7 3 3 0 4 0899200251 VE 1 Helm Pro-Tek 6-punts VEILIGHEIDSHELM PRO TEK PRO WIT	
 4 0 4 5 9 8 9 4 7 3 3 1 1 0899200252 VE 1 Helm Pro-Tek 6-punts VEILIGHEIDSHELM PRO TEK PRO GEEL		 4 0 4 5 9 8 9 4 7 3 3 2 8 0899200253 VE 1 Helm Pro-Tek 6-punts VEILIGHEIDSHELM PRO TEK PRO BLAUW	
 4 0 5 2 7 1 2 1 9 9 7 9 0 0899200290 VE 1 Veiligheidshelm voor werken op hoogte VEILIGHEIDSHELM-EN397/EN12492		 4 0 6 1 9 7 5 3 5 5 6 8 3 0899300430 VE 1 WNA 200/F gehoorbescherming GEHOORKAPPEN-(WNA 200F)	
 4 0 6 5 2 3 3 0 2 5 5 3 0 0899110433 VE 10 Vouwmasker FMH 4000 V FFP2 NR D Met ventiel STOFMASKER-FMH4000-FFP2-VENTIEL		 4 0 4 7 3 7 6 0 4 4 4 3 2 0899200980 VE 1 Stootpet BASEBALL BESCHERMOCAP BLAUW	
 4 0 6 1 9 7 5 3 5 5 6 9 0 0899300410 VE 1 WNA 200 gehoorbescherming Met zeer goede ... GEHOORKAPPEN-(WNA 200)			

STOFMASKERS, HELMEN & OORKAPPEN

Stofmaskers FFP 1

Zonder ventiel

Art.nr. 0899 110 500

Met ventiel

Art.nr. 0899 110 501



Stofmaskers FFP 2

Zonder ventiel

Art.nr. 0899 110 502

Met ventiel

Art.nr. 0899 110 503

filtering onaangename geuren

Met ventiel

Art.nr. 0899 110 505



WNA 200

gehoorbescherming

- Met zeer goede isolatie-eigenschappen en in hoogte verstelbare hoofdband
- Zeer comfortabel Gewatteerde hoofdband en zachte afdichtkussens

Art.nr.

0899 300 410



Stofmaskers FFP 2

Met ventiel

Art.nr. 0899 110 504



Vouwmasker FMH 4000 V FFP2 NR D met ventiel

Comfortabel om te dragen, zelfs voor gebruikers die een bril dragen dankzij de zachte materialen en speciale vorm, waarin de luchtstroom tijdens uitademing naar beneden wordt afgeblazen.



Art.nr. 0899 110 433

WNA 200/F

Gehoorbescherming

In hoogte verstelbaar. Ideaal voor geluidsbereik tussen 102 en 111 dB.

Art.nr.

0899 300 430



Helm PRO-TEK 6-punts

- Verstelbare draaiknop
- Goede nekbescherming



Rood

Art.nr. 0899 200 250

Wit

Art.nr. 0899 200 251

Geel

Art.nr. 0899 200 252

Blauw

Art.nr. 0899 200 253

Veiligheidshelm voor werken op hoogte

- Werken op hoogte
- Zeer prettig draagcomfort
- EN 397 / EW12492

Art.nr. 0899 200 290



Stootpet

Sportieve hoofdbescherming in een modern baseball cap-design voor alle toepassingen waarbij gevaar bestaat voor het stoten van het hoofd.

Art.nr. 0899 200 980



WÜRTH BARCODE

VEILIGHEID, EHBO EN ANTI-GLADHEID



0893000179 VE 40
Wegenzout
STROOIZOUT ZAK 25KG



0899511805 VE 1
Oogspoeling spuitbus
OOGDOUCHE SPRAY 240 ML



089951224 VE 1
Lijmvrije pleister, Elast latexvrij, bei...
LIJMVRIJE-PLEISTER-ELAST-6X450CM



0899520102 VE 100
Vingerverband, textiel
ELASTISCHE TEXTIEL PLEISTER 20X180MM



0899520602 VE 1
BHV Verbandkoffer HOK 2021
BHV KOFFER HOK 2021



0890600154 VE 1
UV 50 zonnebrandlotion
ZONNELOTION-UV50-250ML



0899511803 VE 1
Oogspoeling spuitbus, wandstation
OOGDOUCHE 3 X 240 ML INCL. DISPLAY



089951223 VE 1
Dispenser
DISPENSER VOOR ELAST-L27XW12XH17CM



089951225 VE 1
Lijmvrije pleister, Elast, levensmiddele...
LIJMVRIJE-PLEISTER-ELAST-6X450CM-BLAUW



0899520704 VE 1
Bestel- en vrachtwagentrommel Nederland ...
VERBANDTROMMEL+WANDKLEM BESTELAUT



0899520707 VE 1
Verbandtrommel B
VERBANDTROMMEL-KUNSTSTOF B



0893152 VE 1
Huidbeschermende lotion Special
HUIDBESCHERMINGSLOTION 200 ML



VEILIGHEID, EHBO EN ANTI-GLADHEID

Oogdouchehouder

3x Oogdouche 240 ml
Art.nr. 0899 511 803

Navulling los oogdouche 240 ml
Art.nr. 0899 511 805



BHV verbandkoffer

Uitgebreide verbandkoffer volgens richtlijnen van Het Oranje Kruis

Art.nr. 0899 520 602



Verbandtrommel, EHBO doos

- Type B
- Klein
- Met wandbeugel

Art.nr. 0899 520 707



Pleister

450 cm, vulkaniserend
Art.nr. 0899 512 24

Houder
Art.nr. 0899 512 23



Pleisterstrips

- 18 cm lang
- Doos van 100 stuks

Art.nr. 0899 520 102



Bestel- en vrachtwagen- verbandtrommel

- Groot
- Met wandhouder

Art.nr. 0899 520 704



Huidbeschermings- lotion 200 ml

Art.nr. 0893 152



Zonnebrandlotion UV 50 250 ml

Art.nr. 0890 600 154



POETSPAPIER, PAPIERROLLEN & HANDDOEKROLLEN

Poetspapier / handdoekrollen

Wit

- 19,5 cm
- **1-laags**
- 1000 vel
- 300 meter per rol

Art.nr. 0899 800 654

VE/st. 6 rol

tbv dispenser

Art.nr. 0899 800 421



Dispenser

Art.nr. 0899 800 421



Poetspapier / handdoekrollen, ECO

Wit

- 21 cm
- **2-laags**
- 400 vel
- 152 meter per rol

Art.nr. 0899 810 481

VE/st. 6 rol



Dispenser

Art.nr. 0899 800 194



Poetspapier Eco-line

Wit

- 22 cm
- **2-laags**

1500 vel, 540 meter per rol

Art.nr. 0899 800 290

VE/st. 2 rol



POETSPAPIER, PAPIERROLLEN & HANDDOEKROLLEN

Poetspapier

Wit

- 28 cm
- **1-laags**
- 2500 vel
- 950 meter per rol

Art.nr. 0899 480 595

VE/st. 2 rol



Poetspapier

Blauw

- 38 cm,
- **2-laags**
- 1000 vel
- 360 meter per rol

Art.nr. 0899 800 773

VE/st. 2 rol



Poetspapier Eco-line

Blauw

- 38 cm
- Zeer sterk
- **3-laags**

500 vel, 180 meter per rol

Art.nr. 0899 800 850

1000 vel, 360 meter per rol

Art.nr. 0899 800 823

VE/st. 2 rol

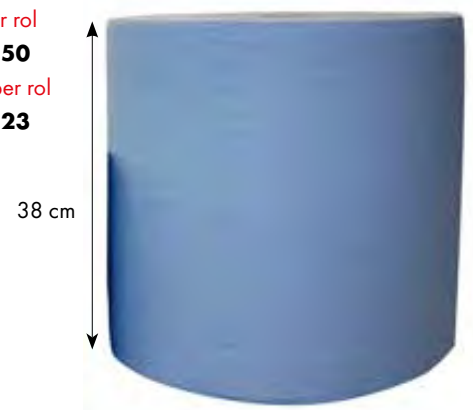

Papieren handdoek

Wit

- 21 x 21 cm
- **2-laags**
- 15 pak
- 170 handdoeken per pak
- Totaal 2550 stuks

Art.nr. 0993 997 085



Dispenser voor papieren handdoeken

Wit

- 40 cm hoog

Art.nr. 0993 997 130



WÜRTH BARCODE

HOUDERS VOOR PAPIER, POETSDOEKEN EN ZEEP

<p>0891900510 VE 1 Heavy duty Handreiniger dispenser DISPENSER HANDCLEANER 4L ZAK</p>	
<p>089316404 VE 1 Handreiniger Heavy Duty Sterk HANDREINIGER- HEAVY DUTY - ORANJE 4L</p>	
<p>0899800200 VE 1 Poetsdoek, textiel POETSLAPPEN (250 ST)IN DISPENSER</p>	
<p>0899800421 VE 1 Dispenserdoos voor reinigingspapier DISPENSER BOX VOOR HANDPAPIER</p>	
<p>0899800606 VE 1 Afrolstandaard, reinigingspapier BODEMSTANDAARD TBV POETSPAPIER</p>	
<p>0899800609 VE 1 Tafelrolhouder voor reinigingspapier CLNPAPHOLD-METAL-TABLE-RED</p>	
<p>0899800773 VE 2 Poetspapier Ecoline op rollen POETSPAPIER 2L BLAUW B38CM L360M 1000VEI</p>	
<p>0899800850 VE 2 Poetspapier Ecoline op rollen POETSPAPIER 3L BLAUW B38CM L180M 500VEL</p>	
<p>0993997085 VE 1 Papieren handdoek PAPHNDDOEK-2LAAGS-2790STK-21,5X21CM</p>	
<p>0899480595 VE 2 Reinigingspapier POETSPAPIER-1-LAAGS-CELL-28X37CM-1000M</p>	
<p>0899800109 VE 1 Poetsdoek, textiel POETSLAPPEN-BONT-9KG-PASTEL-TRICOT</p>	

<p>0891935 VE 1 Elektrische dispenser Touch Free TOUCH FREE ZEEP DISPENSER 5ML 120X250MM</p>	
<p>089393410 VE 1 Handreiniger Groen ECOLINE HANDREINIGER VOOR DISP. 3000ML</p>	
<p>0899800290 VE 2 Poetspapier Ecoline op rollen POETSPAPIER 2L WIT B22CM L540M 1500VEL</p>	
<p>0899800550 VE 25 Afalzak VUILNISZAK STERK 700X1100X0,04 BLAUW</p>	
<p>0899800607 VE 1 Wandrolhouder voor rollen reinigingspapi... WANDHOUDER TBV POETSPAPIER</p>	
<p>0899800653 VE 6 Poetspapier voor dispenser POETSPAPIER 1L WIT B19CM L260M 865VEL CF</p>	
<p>0899800823 VE 2 Poetspapier Ecoline op rollen POETSPAPIER 3L BLAUW B38CM L360M 1000VEI</p>	
<p>0899810481 VE 6 Reinigingspapier PSTPAP-ÉCO-2LAGEN-L152M-400VELS</p>	
<p>0993997130 VE 1 Papieren handdoekdispenser DSPAPHANDDOEK-40X27X14CM</p>	
<p>0899800167 VE 1 Poetsdoek, textiel POETSLAPPEN-WIT-TEXTIEL-8KG-FIJNGESNEDEN</p>	

HOUDERS VOOR PAPIER, POETSDOEKEN EN ZEEP

HOUDERS HANDDOEKROLLEN EN DISPENSERS

Wandhouder poetspapier rood

- Rollen tot 38 cm
- Houder 53 cm breed
- Muurbevestiging
- Met houder voor vuilniszakken



Art.nr. 0899 800 607

Poetsdoeken

Bont, tricot

Art.nr. 0899 800 109 (9 kg)

Wit, badstof

Art.nr. 0899 800 167 (8 ka)



Poetsdoeken

Textiel

Grijs

Art.nr. 0899 800 200

VE/st. 250 stuks in doos



Tafel- of wandhouder poetspapier rood

- Rollen tot 38 cm
- Houder 53 cm breed
- Tafel- of muurbevestiging

Art.nr. 0899 800 609



Dispenser

Los tbv 0893 164 04

Art.nr. 0891 900 510



Dispenserset

Art.nr. 0988 995 064

Inhoud:

1x dispenser 0891 900 510

4x zeep 0893 900 104

Handcleaner, zeep

- Heavy Duty
- Citrus
- 4 liter
- Zonder oplosmiddelen

Art.nr. 0893 164 04



Vloerstandaard poetspapier rood

- Rollen tot 38 cm
- 50 cm breed en 86 cm hoog
- Met wieltjes en vuilniszakhouder

Art.nr. 0899 800 606



Dispenser touch free

Art.nr. 0891 935

Eco line handreiniger 3 liter

Art.nr. 0893 934 10



Afvalzakken

Art.nr. 0899 800 550



KLEDING

Softshell bodywarmer

Art.nr. M442 047 00..

Maat XS t/m 3XL



Bedrukken mogelijk

Met logo of bedrijfsnaam

Meer informatie:

- Zie de uitgebreide Modyf® workwear catalogus
- Mail: modyf@wurth.nl



Softshell jack, one

Art.nr. M441 058 0..

Maat XS t/m 3XL



Modyf® workwear catalogus

www.wurth.nl

Service → Modyf services



Bekijk hier de Modyf catalogus

Logo bedrukken



Transferdruk

Het logo wordt in spiegelbeeld op de transfer aangebracht (minimaal 50 stuks afnemen, maar deze hoeven niet direct allemaal ingezet te worden). Op het gewenste tijdstip kan de transfer middels hitte en 5 bar druk op de kleding worden aangebracht. Voordeel: u kunt voor bijvoorbeeld 1,5 jaar transfers aankopen (hoe groter het volume, hoe goedkoper de transfer) en kunt die op elk gewenst tijdstip inzetten, ook als u slechts 1 kledingstuk nodig heeft. Maximale flexibiliteit.



Zeefdruk

De drukkleur wordt direct op het textiel aangebracht en trekt in de vezel. Deze vorm van bedrukken is voordelig als het om grote aantallen gaat. Hier dient u echter altijd een minimaal aantal te hebben om te kunnen herdrukken. Bij een eerste aanvraag komen hier filmkosten bij à € 20,- per kleur en bij elke bedrukking € 30,- zeefkosten per kleur.



Borduren

Een hoogwaardige variant waarbij de prijs afhankelijk is van het aantal steken en de complexiteit van het logo. Hierdoor wordt die vaak alleen als borstlogo ingezet.

Stretch X Overall

Grijs

Art.nr. M405 100 ...

Maat S t/m 4XL

Antraciet

Art.nr. M405 101 ...

Maat S t/m 4XL



Peter Fleecejack

Zwart

Art.nr. M456 080 ...

Maat XS t/m 3XL*

Blauw

Art.nr. M356 125 ...

Maat XS t/m 3XL*

Antraciet

Art.nr. M356 126 ...

Maat XS t/m 3XL*

Rood

Art.nr. M356 127 ...

Maat XS t/m 3XL*

Groen

Art.nr. M456 099 ...

Maat XS t/m 3XL*

*4XL op aanvraag



PASSERVICE WÜRTH MODYF



Würth wil u, de klant, graag ontzorgen en heeft daarom vanaf heden een passervice op wielen in de vorm van de MODYF bus. De medewerker op deze bus, Kevin van den Bogaard, is gespecialiseerd in werkkleding en -schoenen en kan u tevens begeleiden in het proces van logobedrukking op uw kleding.

De Modyfbus is dé perfecte oplossing voor mensen die geen tijd, zin of mogelijkheden hebben om onze Würth shops te bezoeken. In de bus vindt u een ruime keuze uit onze collectie Modyf werkkleding en -schoenen.

U bent in één keer klaar!

- Direct kleding en schoenen kunnen bekijken, passen en vergelijken.
- Geen medewerkers die te pas en te onpas onder werktijd bij plaatselijke leveranciers gaan passen, maar op een door u te bepalen tijdstip. Dit bespaart u veel ritjes en geduld.
- Geen retouren, maar 1x alles doorpassen.
- Mogelijkheid tot logobedrukking op de kleding (niet ter plekke).

De bus gaat rijden volgens een regionale indeling.

U kunt een bezoek van de Modyfbus aanvragen via het formulier op www.wurth.nl/modyf-pasbus



scan QR-code voor
meer informatie

KLEDING

Poloshirt

Grijs
Art.nr. M047 056 ...
Maat XS t/m 6XL



Oranje
Art.nr. M047 057 ...
Maat XS t/m 6XL

Rood
Art.nr. M047 058 ...
Maat XS t/m 6XL



Kobaltblauw
Art.nr. M047 059 ...
Maat XS t/m 6XL

Marineblauw
Art.nr. M047 060 ...
Maat XS t/m 6XL



Grafiet
Art.nr. M047 061 ...
Maat XS t/m 6XL

Stretch X Bermuda

Antraciet
Art.nr. M413 106 ...
Maat 44 t/m 64

Blauw
Art.nr. M413 107 ...
Maat 44 t/m 64

Wit
Art.nr. M413 112 ...
Maat 44 t/m 64



Stretch X Werkjack

Grijs
Art.nr. M401 250 ...
Maat S t/m 3XL



Blauw
Art.nr. M401 252 ...
Maat S t/m 3XL

Wit
Art.nr. M401 272 ...
Maat S t/m 3XL



Stretch X Bandbroek

Grijs
Art.nr. M403 311 ...
Maat 25 t/m 114

Antraciet
Art.nr. M403 312 ...
Maat 25 t/m 114

Blauw
Art.nr. M403 313 ...
Maat 25 t/m 114

Wit
Art.nr. M403 238 ...
Maat 25 t/m 114



WÜRTH BARCODE

SIGNAALVESTEN, REGENKLEDING EN LAARZEN

<p>0899078006 VE 1 Signaalvest RWS klasse 2 SIGNAALVEST-RWS-GEEL-XL</p> 	<p>0899078008 VE 1 Signaalvest RWS klasse 2 SIGNAALVEST-RWS-ORANJE-XL</p> 
<p>5359002014 VE 1 Regenparka klasse 3 (RWS) RWS PARKA EN 471 / 343 ORANJE MT L</p> 	<p>5359002015 VE 1 Regenparka klasse 3 (RWS) RWS PARKA EN 471 / 343 ORANJE MT XL</p> 
<p>5359002016 VE 1 Regenparka klasse 3 (RWS) RWS PARKA EN 471 / 343 ORANJE MT XXL</p> 	<p>5359002013 VE 1 Regenparka klasse 3 (RWS) RWS PARKA EN 471 / 343 ORANJE MT M</p> 
<p>M411168000 VE 1 Regenpak EN 343, klasse 3:1 MOD REGENSET EN343 BLAUW MT. S</p>  <p>MT S</p>	<p>5359002015 VE 1 Regenparka klasse 3 (RWS) RWS PARKA EN 471 / 343 ORANJE MT XL</p> 
<p>M411168002 VE 1 Regenpak EN 343, klasse 3:1 MOD REGENSET EN343 BLAUW MT. L</p>  <p>MT L</p>	<p>5359002017 VE 1 Regenparka klasse 3 (RWS) RWS PARKA EN 471 / 343 ORANJE MT XXXL</p> 
<p>M411168004 VE 1 Regenpak EN 343, klasse 3:1 MOD REGENSET EN343 BLAUW MT. XXL</p>  <p>MT XXL</p>	<p>M411168001 VE 1 Regenpak EN 343, klasse 3:1 MOD REGENSET EN343 BLAUW MT. M</p>  <p>MT M</p>
<p>M423008042 VE 1 Dunlop rubberlaarzen, S5 DUN RUBBEREN LAARS S5 MT. 42</p>  <p>MT 42</p>	<p>M411168003 VE 1 Regenpak EN 343, klasse 3:1 MOD REGENSET EN343 BLAUW MT. XL</p>  <p>MT XL</p>
<p>M423008044 VE 1 Dunlop rubberlaarzen, S5 DUN RUBBEREN LAARS S5 MT. 44</p>  <p>MT 44</p>	<p>M411168005 VE 1 Regenpak EN 343, klasse 3:1 MOD REGENSET EN343 BLAUW MT. 3XL</p>  <p>MT 3XL</p>
	<p>M423008043 VE 1 Dunlop rubberlaarzen, S5 DUN RUBBEREN LAARS S5 MT. 43</p>  <p>MT 43</p>
	<p>M423008045 VE 1 Dunlop rubberlaarzen, S5 DUN RUBBEREN LAARS S5 MT. 45</p>  <p>MT 45</p>

SIGNAALVESTEN, REGENKLEDING EN LAARZEN

Veiligheidsvest RWS

Oranje
Art.nr. 0899 078 008
 Geel
Art.nr. 0899 078 006



Neon signaal jack gewatteerd klasse 3

Oranje
Art.nr. 409 278 ...
 Maat S t/m 4XL



Signaal winterjack klasse 3 RWS

Oranje
Art.nr. 5359 002 21.
 Maat S t/m 4XL



Regenpak

Blauw **Art.nr. M411 168 00..**
 (maten - zie barcodeblad)

Oranje regenparka
Art.nr. 5359 002 01.



Veiligheidslaars S5 geel

Art.nr. M423 008 0.. (maat)
 Maat 38 t/m 48
 (maten 42 t/m 45 - zie barcodeblad)



WÜRTH BARCODE SCHOENEN EN LAARZEN

0899030888 VE 1
Fento kniebeschermers PRO 200
KNEIBESCHERMERS-FENTO-PRO 200

5357127430 VE 1
Veiligheidslaars GS90 S3
VEILIGHEIDSLAARS GS90-S3-MT 43

5357127450 VE 1
Veiligheidslaars GS90 S3
VEILIGHEIDSLAARS GS90-S3-MT 45

5357127470 VE 1
Veiligheidslaars GS90 S3
VEILIGHEIDSLAARS GS90-S3-MT 47

5357937430 VE 1
CATERPILLAR FRAMEWORK HALFHOGE
HH VEILIGHSCHOEN-S3-CAT-FRAMEWORK-MT

5357937450 VE 1
CATERPILLAR FRAMEWORK HALFHOGE
HH VEILIGHSCHOEN-S3-CAT-FRAMEWORK-MT

M022074042 VE 1
Techno S3 FLEXITEC® halfhoge veiligheid...
HALFHOGE SCHOEN FLEXITEC TECHNO S3 MT4

M022074044 VE 1
Techno S3 FLEXITEC® halfhoge veiligheid...
HALFHOGE SCHOEN FLEXITEC TECHNO S3 MT4

M022074046 VE 1
Techno S3 FLEXITEC® halfhoge veiligheid...
HALFHOGE SCHOEN FLEXITEC TECHNO S3 MT4

M422149042 VE 1
Hercules S3 veiligheidsschoen
HH VEILIGHEIDSSCHOEN HERCULES-S3-MT42

M422149044 VE 1
Hercules S3 veiligheidsschoen
HH VEILIGHEIDSSCHOEN HERCULES-S3-MT44

M422149046 VE 1
Hercules S3 veiligheidsschoen
HH VEILIGHEIDSSCHOEN HERCULES-S3-MT46

5357127420 VE 1
Veiligheidslaars GS90 S3
VEILIGHEIDSLAARS GS90-S3-MT 42

5357127440 VE 1
Veiligheidslaars GS90 S3
VEILIGHEIDSLAARS GS90-S3-MT 44

5357127460 VE 1
Veiligheidslaars GS90 S3
VEILIGHEIDSLAARS GS90-S3-MT 46

5357937420 VE 1
CATERPILLAR FRAMEWORK HALFHOGE
HH VEILIGHSCHOEN-S3-CAT-FRAMEWORK-MT

5357937440 VE 1
CATERPILLAR FRAMEWORK HALFHOGE
HH VEILIGHSCHOEN-S3-CAT-FRAMEWORK-MT

5357937460 VE 1
CATERPILLAR FRAMEWORK HALFHOGE
HH VEILIGHSCHOEN-S3-CAT-FRAMEWORK-MT

M022074043 VE 1
Techno S3 FLEXITEC® halfhoge veiligheid...
HALFHOGE SCHOEN FLEXITEC TECHNO S3 MT4

M022074045 VE 1
Techno S3 FLEXITEC® halfhoge veiligheid...
HALFHOGE SCHOEN FLEXITEC TECHNO S3 MT4

M022074047 VE 1
Techno S3 FLEXITEC® halfhoge veiligheid...
HALFHOGE SCHOEN FLEXITEC TECHNO S3 MT4

M422149043 VE 1
Hercules S3 veiligheidsschoen
HH VEILIGHEIDSSCHOEN HERCULES-S3-MT43

M422149045 VE 1
Hercules S3 veiligheidsschoen
HH VEILIGHEIDSSCHOEN HERCULES-S3-MT45

M422149047 VE 1
Hercules S3 veiligheidsschoen
HH VEILIGHEIDSSCHOEN HERCULES-S3-MT47

SCHOENEN & LAARZEN

<p>M422149048 VE 1 Hercules S3 veiligheidsschoen HH VEILIGHEIDSSCHOEN HERCULES-S3-MT48</p>	<p>M022073042 VE 1 Arcori Plus S3 FLEXITEC<SUP>@</SUP> hal. HALFHOGE SCHOEN FLEXITEC ARCORI S3 MT4:</p> <p>MT 42</p>
<p>M022073043 VE 1 Arcori Plus S3 FLEXITEC<SUP>@</SUP> hal. HALFHOGE SCHOEN FLEXITEC ARCORI S3 MT4:</p> <p>MT 43</p>	<p>M022073044 VE 1 Arcori Plus S3 FLEXITEC<SUP>@</SUP> hal. HALFHOGE SCHOEN FLEXITEC ARCORI S3 MT4:</p> <p>MT 44</p>
<p>M022073045 VE 1 Arcori Plus S3 FLEXITEC<SUP>@</SUP> hal. HALFHOGE SCHOEN FLEXITEC ARCORI S3 MT4:</p> <p>MT 45</p>	<p>M022079042 VE 1 Veiligheidslaars bouw AS S3 MOD HH BOUWSCHOEN AS S3 MT 42</p> <p>MT 42</p>
<p>M032004999 VE 1 Kniebeschermers MODYF<SUP>@</SUP>PR MODYF PRO KNEKUSSEN EN 14404</p>	

Veiligheidsschoen ARCORI S3

Art.nr. M022 073 0.. (maat)
Maat 38 t/m 48
(maten 42 t/m 45 -
zie barcodeblad)



HERCULES S3 Veiligheidsschoen

Art.nr. M4221 490 .. (maat)
Maat 42 t/m 48



CATERPILLAR Frame- work Veiligheidsschoen

Art.nr. 5357 937 4.. (maat)
Maat 42 t/m 46



Veiligheidsschoen TECHNO S3 FLEXITEC

Art.nr. M0220 740 .. (maat)
Maat 42 t/m 47
BOA snelsluiting



Veiligheidslaars GEVAVI GS85 S3

Art.nr. 5357 127 4.. (maat)
Maat 40 t/m 47



Veiligheidslaars S3 Winter XOrion

Art.nr. M422 168 0.. (maat)
Maat 40 t/m 48



Kniekussens

Art.nr. M437 484 999



Kniebeschermers FENTO PRO 200

Art.nr. 0899 030 888



WÜRTH BARCODE

BEDRIJFSWAGENS EN ORSY® MOBIL

<p>0555305517 VE 5 7-polige stekker 12 V STEKKER 7-POLIG ALU.</p> 	<p>071392 11 VE 1 Spanband met ratel, eendelig met standaa... SPANBAND IDELIG 1T B50MM-L8M</p> 
<p>071392 207 VE 1 Spanband met standaard ratel SPANBAND KARABIJNHAAK 5T B50MM-L8M</p> 	<p>071392 22 VE 4 Spanslot sjoband, eendelig SPANBAND KLEMGESP 1 DELIG 0,25T B25MM-5M</p> 
<p>0713925105 VE 1 Ratelspanband, dubbele haak, lange hende... SPANBAND GESL.DR.HAAK ERGÖ 5T B50MM-L1</p> 	<p>07201101 VE 10 Halogeenlamp HALÖG.LAMP H4 12V 60/55W</p> 
<p>072011412 VE 10 Halogeenlamp Longlife HALÖG.LAMP H7 LONG-LIFE 12V 55W</p> 	<p>07209614 VE 1 Box enkele reservegloeilampen auto H4 RESERVELAMPENSET H4-12V-9PCS</p> 
<p>07209617 VE 10 Box enkele reservegloeilampen auto H7 RESERVELAMPENSET H7-12V-9PCS</p> 	<p>0880270250 VE 1 Trailernet LADINGNET 2,7X2,5M</p> 
<p>0880270311 VE 1 Trailernet BESCHERMNET, -ZEIL-PP-45MM-2,7X3,1M</p> 	<p>0880270350 VE 1 Trailernet LADINGNET 2,7X3,5M</p> 
<p>0892332925 VE 1 Ruitenvloeistof Ruitenreiniger Plus RUITENREINIGER ANTIVRIES -60GRADEN 500M</p> 	<p>0892332929 VE 1 Ruitenvloeistof Ruitenreiniger Plus RUITENREINIGER ANTIVRIES -60GRADEN 60L</p> 
<p>0892332944 VE 1 RUITENREINIGER ANTIVRIES READY-TO- RUITENREINIGER -20 READY-TO-USE 5L</p> 	<p>0892333 VE 25 Ruitenvloeistof Snelreiniger in displayd... SNELREINIGER 32 ML</p> 
<p>096383 741 VE 1 Ladderklemsysteem LADDERKLEMSET-PAAR-RHSC01</p> 	

BEDRIJFSWAGENS

Ruitenreiniger / ruitenwisservloeistof

Antivries -/ -20°C • direct klaar • 5 liter • blauw

Art.nr. 0892 332 944

Antivries -/ -60°C • of verdunnen • 0,5 liter • blauw

Art.nr. 0892 332 925

Zomer • anti-insecten • 1:100 • 32 ml • oranje (displaydoos 25 st.)

Art.nr. 0892 333



Spanbanden

Art.nr. 0713 92 ..



Ladderklem

Art.nr. 0963 83 741

VE/paar 1



Net voor aanhangwagen

Art.nr. 0880 270 ... (maat)

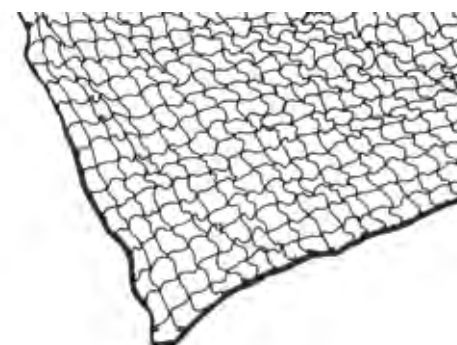

Reservelampen 12V

Halogeenlamp H7 Longlife

Art.nr. 0720 114 12

Halogeenlamp H4

Art.nr. 0720 110 1

VE/st. 10

Reservelampen set H7

Art.nr. 0720 961 7

Reservelampen set H4

Art.nr. 0720 961 4

VE/set 9-delig

H4



H7



7-polige stekker 12V

Art.nr. 0555 305 517



Voor de complete bedrijfswageninrichtingen

Wilt u meer informatie over ORSY® *mobil*? Dan kunt u telefonisch contact met ons opnemen op tel.nr. +31 (0)73 629 1490 of neem contact op met uw vertegenwoordiger.

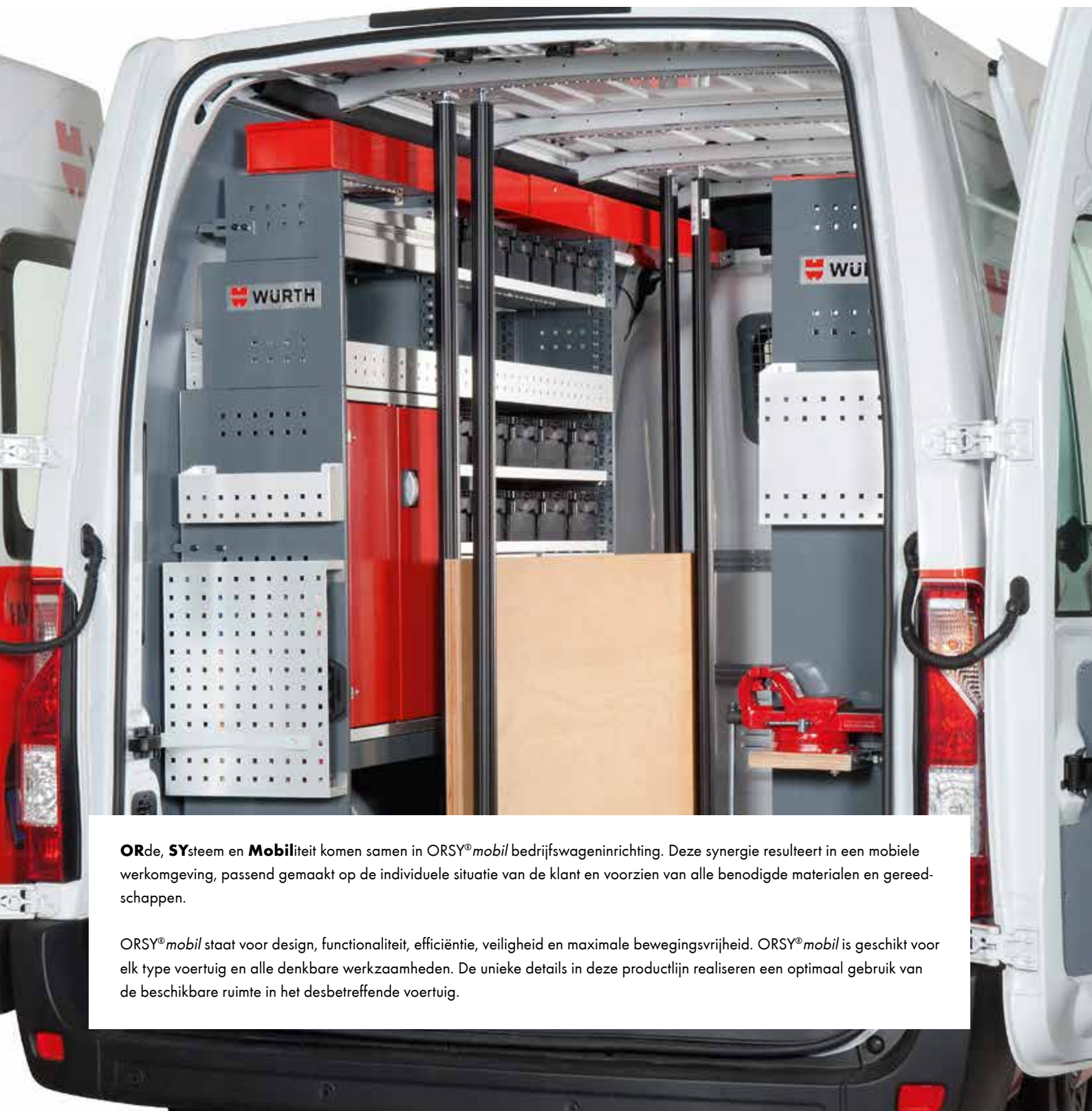

ORde, **SY**steem en **Mobil**iteit komen samen in ORSY® *mobil* bedrijfswageninrichting. Deze synergie resulteert in een mobiele werkomgeving, passend gemaakt op de individuele situatie van de klant en voorzien van alle benodigde materialen en gereedschappen.

ORSY® *mobil* staat voor design, functionaliteit, efficiëntie, veiligheid en maximale bewegingsvrijheid. ORSY® *mobil* is geschikt voor elk type voertuig en alle denkbare werkzaamheden. De unieke details in deze productlijn realiseren een optimaal gebruik van de beschikbare ruimte in het desbetreffende voertuig.

AANVULLING EIGEN BARCODESTICKERS

AANVULLING EIGEN BARCODESTICKERS

AANVULLING EIGEN BARCODESTICKERS

AANVULLING EIGEN BARCODESTICKERS

AANVULLING EIGEN BARCODESTICKERS

AANVULLING EIGEN BARCODESTICKERS



WIJ BOUWEN SAMEN.

Bouwplaats-Project-Management

Onze dienstverlening:

- Bouwplaats shops met service ter plaatse.
- Afzonderlijk ingerichte materiaaldepots.
- Op de montageplaats afgestemde afname- en bevoorradingsystemen.
- Just-in-time-levering van geprefabriceerde goederen.
- Gedetailleerde leveringsdocumentatie.

Uw voordelen:

- Materialen altijd ter plaatse.
- Geen dure bouwonderbrekingen.
- Snellere en zekere bouwvoortgang.
- Tijdwinst maakt concentratie op de kernactiviteiten mogelijk.
- Duidelijke kostenreductie.
- Optimale service.
- Vervallen van opslagkosten, geen kapitaalbinding.
- Eén aanspreekpartner, altijd bereikbaar.



**READY
FOR WORK**

BOUWBOEK

Uitgave van
Würth Nederland B.V.
Postbus 344, 5201 AH
's-Hertogenbosch
T +31 (0)73 629 1911
F +31 (0)73 629 1922
info@wurth.nl
www.wurth.nl

© Würth Nederland B.V.
Verantwoordelijk voor de inhoud: J. de Lang en A. Komdeur
Grafische opmaak: J. van Gestel

Niets uit deze uitgave mag worden vervoelvoudigd en/of openbaar gemaakt door middel van druk, fotokopie, microfilm of op welke andere wijze dan ook zonder voorafgaande schriftelijke toestemming van de uitgever.

DTP - JG - GIM - 10/23