

NATIVE FISH IN THE CLASSROOM

Teacher Guide

Paddlefish (*Polyodon spathula*)



Angela Capello
Louisiana Department of Wildlife and Fisheries

Rachel Somers
Louisiana Sea Grant College Program

Charlotte Bihm
St. Landry Parish School System

Nicole Smith
Coastal Fisheries Institute, Louisiana State University



This publication was produced by the Louisiana Sea Grant College Program, a part of the National Sea Grant College Program maintained by the National Oceanic and Atmospheric Administration of the U.S. Department of Commerce. Louisiana Sea Grant is also supported by the State of Louisiana.
Louisiana Sea Grant, June 2005.

167-14-5106, PAWS, Nexpress, Q60, 80# white, dull text, b/w, Cover/spine 11x17 gloss text

Table of Contents

Acknowledgements.....	vi
Introduction.....	vii
SECTION 1: Background Information.....	1
Biology of the Paddlefish.....	3
Characteristics.....	3
Spawning.....	4
Feeding.....	5
Range.....	6
Habitat.....	6
Causes of Population Decline.....	7
Caviar Industry.....	7
Conservation.....	9
Aquatic Invasive Species.....	10
Fisheries Management.....	12
Role of Hatcheries.....	12
What is a Hatchery?.....	12
Why are Hatcheries Important?.....	12
Booker Fowler Fish Hatchery.....	13
Interesting Facts.....	15
SECTION 2: Aquarium Setup and Maintenance.....	17
Equipment for Aquarium Setup and Maintenance.....	19
Aquarium Setup.....	20
Logbook.....	21
Water Quality Monitoring.....	21
How to Change the Water.....	23
Vacuuming.....	23
Incubation Jar Setup.....	23
Fry Basket/Nursery Setup.....	24
Feeding.....	25
How to Use the Automatic Feeder.....	26
<i>Daphnia</i> spp. Setup.....	27
Problem Solving.....	28

SECTION 3: APPENDICES.....	33
APPENDIX I:	
LESSON PLANS.....	A1
Water Quality	
My Fish Ride a (Nitrogen) Cycle	
Do You Believe in pH Magic?	
General Information on Paddlefish	
Snagging Paddlefish Information	
Critical Conditions for Paddlefish Spawning	
How Old is that Fish?	
Effects on Paddlefish Populations	
Extirpated? Don't you Mean Extinct?	
What a Nuisance!	
Do Dams Affect the Paddlefish Population?	
Paddlefish Growth, Development and Behavior	
How Fast Do Paddlefish Grow?	
Comparing Eggs and Embryos	
Life Cycles of the Wet and Wiggly	
Pass the Water Fleas, Please	
APPENDIX II:	
References.....	A119
APPENDIX III:	
Louisiana Learning Standards, Grade Level Expectations Matrix for Lesson Plans and Definitions of Louisiana Learning Standards.....	A131
Appendix IV:	
Glossary.....	A139
Appendix V:	
Paddlefish Status Chart, Fry Diagram, Aquatic Hours Sheet and Water Quality Monitoring Log.....	A143
Contact:	
Angela Capello	
Wildlife Educator III	
Louisiana Department of Wildlife and Fisheries	
Booker Fowler Fish Hatchery	
10 Joan Stokes Road	
Forest Hill, LA 71430	
Phone: 318-748-6999	
capelloa@centurytel.net	

www.lamer.lsu.edu/projects/nativefish/index.htm

Project Partners



Louisiana Department of Wildlife and Fisheries



Louisiana Sea Grant College Program



St. Landry Parish School System



Louisiana State University, Department of Civil and Environmental Engineering

Louisiana State University

ACKNOWLEDGMENTS

PROJECT MANAGERS

Angela Capello
Louisiana Department of Wildlife and Fisheries

Rachel Somers
Louisiana Sea Grant College Program

PUBLICATION TEAM

Publisher

Louisiana Sea Grant College Program

Contributing Authors

Charlotte Bihm
Nicole Smith

Editors

Marilyn Barrett-O'Leary
Dianne Lindstedt
Paula Ouder

Primary Authors

Angela Capello
Rachel Somers

Lesson Plan Development Team

Charlotte Bihm, teacher liaison
Sabrina Ardoin
Tracy Armand
Lyn Murphy
Kathleen Nichols

Formatting

Jessica Schexnayder

Logo and Diagram Design

Rachel Somers

TECHNICAL ADVISORS

Lance Beecher
Kristi Butler
Bobby Reed

Eric Shanks
Nicole Smith
Paul Smith

CONTRIBUTING IDEAS AND FIELD TESTING

Sabrina Ardoin
Charlotte Bihm
Adam Fredrick

Nick Limberis
Kathleen Nichols
Terry Nichols

PROJECT CONCEPT DEVELOPMENT

Pam Blanchard, Ph.D.
Angela Capello

Inspired by Salmonids in the Classroom, Community Involvement Division, Department of Fisheries and Oceans, Vancouver, British Columbia, Canada

SPECIAL THANKS

Bruce Burrs, Coca-Cola Bottling Company
Adam Fredrick, Maryland Sea Grant College Program
Margaret Frey, Louisiana Cooperative Extension
The Booker Fowler Fish Hatchery Technicians: Shannon Todd Aymond, Gil Blalock, Erin Campbell, Matthew Cloud, Tracy Cloud, Bruce Smith, William Wise and Chris Yancey

PROJECT FUNDING

Louisiana Department of Wildlife and Fisheries Aquatic Education Program
Louisiana Sea Grant College Program

INTRODUCTION

Native Fish in the Classroom is a multidisciplinary, classroom-based project for intermediate, middle and high school students. The overall goal of the project is to assist students in developing an attitude of stewardship toward natural resources and to create a constructive, active learning situation in which they can explore strategies for sustaining aquatic ecosystems.

The following objectives support this goal:

1. Provide students in grades 6 through 12 with background information on fisheries management, fish biology, protected species and aquatic natural resources.
2. Maintain a classroom-based nursery aquarium in which students grow native, Louisiana paddlefish from eggs to fingerlings.
3. Produce paddlefish that can be used by the Louisiana Department of Wildlife and Fisheries' (LDWF) Booker Fowler Fish Hatchery to help manage a protected fish population in Louisiana.
4. Assist students in developing an attitude of stewardship toward the state's natural resources. Students will gain awareness of freshwater ecological systems by helping prevent the loss of a protected fish, benefiting the whole freshwater system.

Why Paddlefish?

The paddlefish is an ideal species to use for studying fish growth and development in the classroom because its life cycle parallels the academic year. Paddlefish fry grow about 1 inch per week and reach about 4 inches in less than two months, allowing students to observe three distinct life stages.

Paddlefish will be raised from eggs to fingerling size in classroom aquatic nurseries and then returned to the hatchery. By participating in the project, teachers will aid LDWF's paddlefish restoration project.

At the hatchery, the fingerlings will be tagged and released into the Atchafalaya River drainage basin system. The fish population will then be monitored on a yearly basis by LDWF district biologists.

Timeline

The project is expected to occupy class time from early March through mid-May. A two-day teacher training workshop is scheduled in the summer for teachers new to the project. In addition, a one-day January workshop ensures successful preparation for receiving paddlefish eggs in the spring. In early March, teachers assist with the artificial spawning process at the hatchery and bring eggs back to their classrooms. Fry will be reared for six to seven weeks to fingerling stage in the classroom nursery tank. At the end of the school year, students will return their 4-to-5-inch, classroom-grown fingerlings to the Booker Fowler Hatchery. Fish will be allowed to grow to about 10 inches and will be tagged and released.

Expected Benefits

Louisiana students will obtain hands-on, real-science knowledge of the state's native aquatic resources.

Louisiana teachers will gain access to the state's Booker Fowler Fish Hatchery as an outdoor classroom. *Native Fish in the Classroom* will also provide hands-on classroom lessons unique to Louisiana.

SECTION 1

**BACKGROUND
INFORMATION**

BIOLOGY OF THE PADDLEFISH

Characteristics

Kingdom - Animalia
Phylum - Vertebrata
Class - Osteichthyes
Subclass - Actinopterygii
Infraclass - Chondrostei
Order - Acipenseriformes
Family - Polyodontidae
Genus - *Polyodon*
Species - *spathula*



Adult paddlefish
(Photo courtesy Richard Condrey)

Paddlefish (*Polyodon spathula*) are gray to bluish freshwater fish, reaching nearly two meters (7 feet) in length and weighing up to 91 kilograms (200 pounds). In Louisiana, adult paddlefish reach an average of 75 to 80 centimeters (2.5 feet) in length and weigh from 4.5 to 7 kilograms (10 to 15 pounds). As its common name suggests, the paddlefish has a long paddle-shaped snout or rostrum equivalent to one-third of the fish's total body length. On the rostrum of the adult paddlefish there are two minute barbels, which are highly visible in its larval (fry) stage. The paddlefish has a large, toothless mouth on the underside of its head. The fish is scaleless, except for a patch near the caudal (tail) fin. The caudal fin is heterocercal, like that of a shark, with the upper lobe longer than the lower lobe. The skeleton of the paddlefish is cartilaginous except for bone-like material found in the dentary (jaw) region. Although the paddlefish looks like it is related to a shark, it is more closely related to sturgeon, gar, bowfin and tarpon.

The paddlefish is one of the largest freshwater fish in North America and may live for more than 50 years. There are two living species of paddlefish in the world, *Polyodon spathula* in the United States and *Psephurus gladius* in the Yangtze River in China. Unlike the American paddlefish, the Chinese paddlefish feeds on other fish, has a sword-like mouth and reaches lengths of 3 meters (9.9 feet).



Fossil paddlefish
(Photo courtesy National Park Service)

The paddlefish is also one of the oldest living fish, dating back 400 million years. It is considered to be a primitive fish, meaning that it is closely related to an early ancestral form and shows little evolution over millions of years. Like its extinct relatives, the paddlefish has a simple body and organ structure, a cartilaginous skeleton and few scales.

Spawning

Paddlefish spawn only under specific environmental conditions. If all conditions are not present, the fish will not reproduce. The three necessary environmental factors are an increase in the photoperiod, a temperature rise and a river rise of 1 to 3 meters. These environmental conditions occur in Louisiana from late February to early March. In more northern latitudes, such as Montana, they may not occur until May.

Males may spawn every year, but females do not. It takes two or more years for a female to produce mature eggs. When ready, a female can produce up to 4.5 to 5.4 kilograms (10 to 12 pounds) of eggs. Once a female has enough eggs, she still may not spawn if the environmental conditions are not favorable. These conditions include clean gravel bars with strong current flows, water temperatures near 13°C (60°F) and high, rising spring water flows. All of these conditions must occur at the same time in order for the female to successfully spawn.

During spawning, a large female, accompanied by several smaller males, swims over selected gravel bars where males release milt (sperm) and females release eggs in the water simultaneously. In Louisiana, paddlefish have adapted to spawn over hard substrates such as logjams and mussel beds because there are few gravel bars. The naturally sticky fertilized eggs adhere to the gravel bars and are not washed away in river currents. The swift current keeps the eggs well oxygenated and prevents debris and silt from covering them. Eggs hatch in about a week. Larval fish are then swept downstream to quieter waters. In a few days, the yolk sac is absorbed and fry begin to feed on zooplankton.

Paddlefish are born without a rostrum, which begins to form shortly after birth. They grow fast, about an inch per week. Despite their ability to grow rapidly, paddlefish mature late in life. Males reach sexual maturity between 7 and 9 years of age, or at one-fourth of their expected life span. Females mature between 10 and 12 years of age, or at one-third of their expected life span.

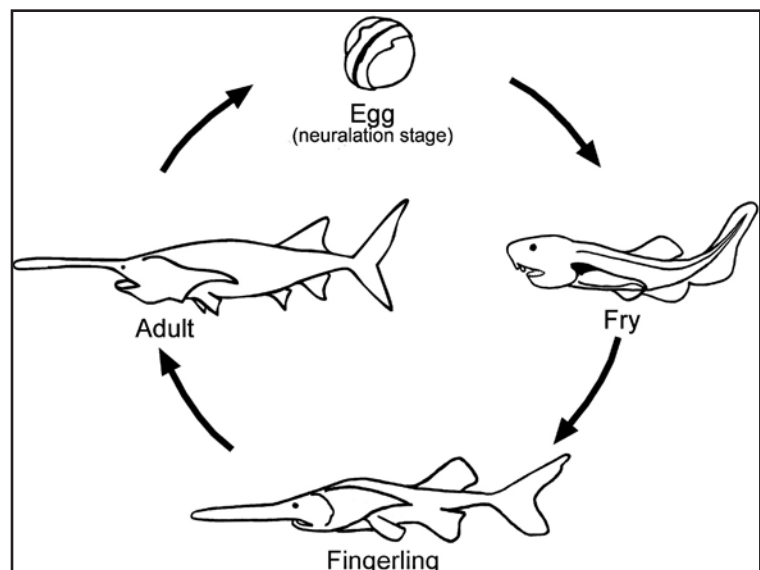

Life cycle of a paddlefish

Feeding

With its large size, the paddlefish would be expected to pursue large prey. However, the paddlefish is a filter feeder, feeding on zooplankton and aquatic insects. *Daphnia* spp., copepods and ostracods comprise the majority of the paddlefish's diet. The fish also feed on small-prey items such as larval fish. The mouth of the paddlefish has numerous gill arches containing filaments called gillrakers, which allow the paddlefish to sieve zooplankton out of the water.

Scientists once believed that the paddlefish used its paddle to dig into the sediment for food, but they have since determined that paddlefish have electroreceptors on their rostrums. These electroreceptors can detect weak electrical fields, allowing paddlefish to use their rostrum like an antenna to find zooplankton. The receptors not only detect the presence of zooplankton, but the individual feeding and swimming movements of zooplankton's appendages as well. Sensory pores extend from the rostrum to the top of the head and to the tips of the operculum (gill flaps). These pores take up nearly half the skin surface of the fish. Paddlefish rely on their electroreceptors to find food because they have poorly developed eyes. If the rostrum is damaged, a paddlefish will still be able to locate food items because of electroreceptors located on the head region. Therefore, the rostrum is not the sole means of food detection.



Electroreceptors on the rostrum of a paddlefish fry
(photo by A. Capello)



Adult paddlefish gillrakers
(photo by N. Smith)

Feeding habits of young paddlefish differ from those of adults. Fingerlings less than 15 centimeters (7 to 8 inches) long do not have well developed gillrakers and are unable to strain zooplankton from the water. At this stage, they are selective feeders, capturing zooplankton one at a time. Some young paddlefish will selectively feed for up to one year or until they reach a total length of 56 to 66 centimeters (22 to 26 inches). Fry and fingerlings also differ from adults because they have teeth. Teeth help them eat food until their gillrakers develop.

Range

In 1542, Spanish explorer Hernando de Soto was the first person to document paddlefish in the Mississippi River (Springer 2000).

At that time, paddlefish were found throughout the Mississippi River drainage basin, including the Great Lakes and rivers in Ontario, Canada. However, paddlefish populations are now extirpated (naturally occurring populations no longer exist) in Canada, Pennsylvania, Maryland, New York and Virginia. Today, the population range is reduced to the Mississippi and Missouri river tributaries and the Mobile Bay drainage basin (Williamson 2003).



Historic range of paddlefish
(Modified from Williamson 2003)

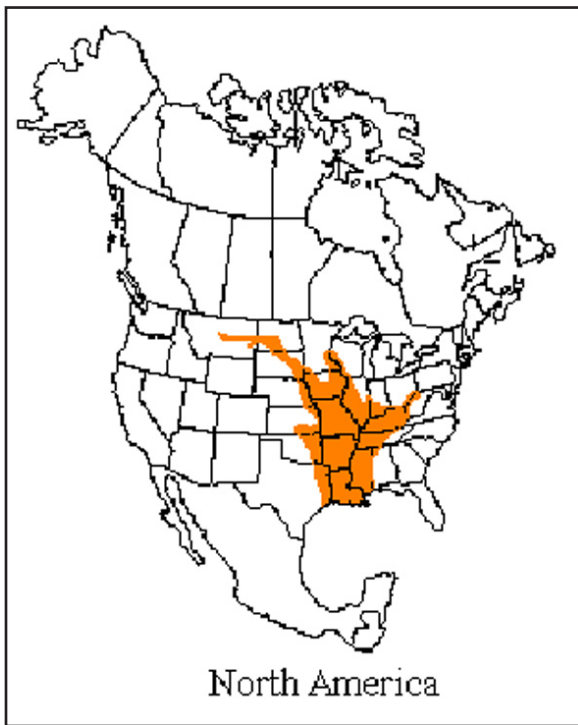

Current range of paddlefish
(USGS Northern Prairie Wildlife Research Center)

In some parts of its current range, paddlefish from stable populations are harvested commercially and as game fish. The meat is considered flavorful. More desirable than the meat are the unfertilized eggs, called roe. Paddlefish roe, like sturgeon caviar, is considered a delicacy. Roe has made the paddlefish an economically valuable species but has had negative effects on the fish's population.

Habitat

Paddlefish are found in many types of river habitats within the Mississippi River drainage basin. Many find homes in deeper, low-current areas of river systems. Some of these areas include side channels, backwaters, oxbow lakes, other river-lakes, and tail waters below dams. The fish are highly mobile and can travel up to 2,000 miles in a river system, typically swimming near the surface.

In Louisiana, paddlefish are found in numerous rivers, lakes and bayous. They are found in the Atchafalaya, Mississippi, Red and Mermentau river basins, and Bayou Nezipique, as well as other freshwater areas. Though primarily a freshwater fish, paddlefish are also found in the estuarine systems of Lake Pontchartrain and Grand Lake.

Causes of Population Decline

Paddlefish populations are declining because human activities have led to habitat alteration, degradation and loss. There are several well-known limiting factors that affect paddlefish populations: dam construction, pollution and overharvesting.

Spawning areas are degraded mainly by human activities to improve flood control and navigation, including dredging of rivers and construction of levees, locks and dams. Dams significantly alter the surrounding environment, affecting all forms of life in the local vicinity in two ways. First, dams form reservoirs with deep, open water and slow currents that may inundate areas that were once ideal paddlefish spawning areas. Secondly, dams reduce water flow downstream, which will increase the release of sediment into the water covering clean gravel bars. Another way dams affect paddlefish populations is by creating barriers that prevent migration to spawning grounds and migration up and down the waterway for food. Pollution from industry, municipalities and agriculture further degrade water quality and remaining paddlefish habitat.

Overharvesting for roe causes additional stress to the declining paddlefish population. This stress becomes more of a concern as sturgeon stocks worldwide rapidly decline and paddlefish, a close relative with similarly sized roe, is sought as a replacement. Paddlefish are found in only 22 states. In many of the states where paddlefish populations are found, the populations are protected under federal or state laws. Only 13 states allow commercial or game fishing.

Caviar Industry

Sturgeon from the Caspian Sea are harvested for their roe. The Caspian sturgeon is the only fish to legally have its roe labeled as “caviar” under the Food and Drug Administration’s (FDA) food labeling regulations, 21 CFR Part 101. If the roe of another species is placed in a container labeled “caviar,” it must include the name of the fish it was taken from with the font of the words the same size and prominence (FDA warning letter 2002).

Overfishing, poaching and industrial pollution have greatly diminished populations of Caspian Sea sturgeon. The five main species of sturgeon from the Caspian Sea used in the caviar trade are all listed as endangered. Therefore, other species of sturgeon and the paddlefish are sought as replacements. With its gray color and nutty flavor, paddlefish roe is very similar in color, size and taste to caviar from Sevruga sturgeon (*Acipenser stellatus*) from the Caspian Sea. In the United States, paddlefish roe can yield fishers \$100 to \$200 per kilogram (\$45 to \$91 per pound) and retail at \$423 per kilogram (\$192 per pound).

Since the 1980s, a trade embargo on Iraq has prevented Caspian Sea sturgeon caviar from entering the United States, limiting U.S. sources of caviar. Five countries - Iraq, Azerbaijan, Kazakhstan, Turkmenistan and the Russian Federation - fish the Caspian Sea for sturgeon. Currently, most caviar comes from sturgeon in the Northern Caspian Sea and is harvested by the states of the former Soviet Union. This population of sturgeon is overfished and poached. Before the Soviet Union broke apart, there were strict regulations on fishing sturgeon, which included efforts by hatcheries to restock the population. Today, hatchery efforts continue, but sturgeon populations are on the decline because sturgeon fishing is an easy and profitable venture for developing countries.

The global demand for caviar is now turning to the United States. At the end of the 1800s, the United States was a major supplier to the global caviar trade. However, overharvesting significantly damaged North American sturgeon populations. Several species of U.S. sturgeon are currently rated endangered or threatened throughout their range, as is the paddlefish in some states. Increased demand for roe from wild fish could have negative impacts on paddlefish populations, since the fish mature slowly.

The U.S. Fish and Wildlife Service (USFWS) has prosecuted several cases of mislabeled paddlefish roe sold as Caspian Sea caviar. One such case was against the owner of a caviar company who was fined and is serving jail time for conspiracy to smuggle a protected species, making false statements to the USFWS, and selling falsely labeled caviar to retail food companies (Department of Justice 2002). In addition to the criminal fine, the owner also paid a community service fine of \$25,000 to the Fish and Wildlife Foundation to preserve and restore sturgeon and paddlefish. DNA testing showed he was selling illegally obtained paddlefish, including protected paddlefish from Alabama, as Sevruga caviar (Department of Justice 2002).

At present, legal, regulated markets for U.S. paddlefish and sturgeon roe sustain healthy, wild populations and allow for commercial harvest. However, rising prices and increased demand for roe may overwhelm this balance. These market pressures threaten to increase poaching and diminish the wild population faster than the aquaculture industry can replace them. Inter-jurisdictional management is needed to ensure that history does not repeat itself.



Roe harvested from female paddlefish
(Photo courtesy Bobby Reed)

Conservation

Depending on the state and the health of the population, the status of the paddlefish population varies from federally protected or state protected to unprotected. In 1992, the paddlefish was listed in Appendix II of the Convention on International Trade in Endangered Species of Wild Fauna and Flora (CITES). CITES is an agreement among governments to ensure that international trade of a species will not threaten the species' survival. Species that are listed in Appendix II are not necessarily threatened to extinction, but trade of these species is regulated. For the specimen to be exported, the exporter must have a permit that certifies that the specimen was not illegally obtained, it will face minimal risk of injury during transport, and the trade of the specimen will not be detrimental to the survival of the species.

In New York, Pennsylvania, Maryland and Virginia, paddlefish populations have become extirpated, meaning they no longer exist in these areas. In many other states, strict laws protect the population. Minnesota, Nebraska, North Carolina, Ohio, Texas, West Virginia and Wisconsin paddlefish populations are threatened, endangered or rate as critically imperiled.

In Louisiana and Alabama, paddlefish are protected, and the population is stable. In Louisiana, there is no legal harvest or possession of paddlefish. Possession includes an "accidental" catch. If a paddlefish is caught, the fish must be released immediately. It is considered "intent of take" if a person places the fish in a tank or ice chest or leaves the fish on a boat. Possession of a paddlefish carries a fine of \$2,750 per fish.

States with sustainable paddlefish populations that can support commercial and/or sport fishing are Arkansas, Illinois, Indiana, Iowa, Kansas, Kentucky, Mississippi, Missouri, Montana, North Dakota, Oklahoma, South Dakota and Tennessee.

A Mississippi River basin-wide conservation effort was formed in 1991 called Mississippi Interstate Cooperative Resource Association (MICRA) to improve inter-jurisdictional management of aquatic resources. MICRA established the Paddlefish/Sturgeon Subcommittee whose mission is to provide information and recommendations to conserve and manage paddlefish through inter-jurisdictional coordination, communication and assessment. The effort of the subcommittee has protected more than 10,000 wild paddlefish and produced 1 million hatchery-reared paddlefish that have been tagged and released throughout the Mississippi basin.

Throughout the paddlefish's natural range there are many programs to help restore the population to healthy, sustainable levels. Hatcheries are very important in this process. Hatcheries raise paddlefish from eggs to fingerlings through artificial propagation of wild stock. Hatchery-raised fish are tagged to monitor populations. Hundreds of thousands of fingerlings are then returned to natural habitat. In Louisiana, the Louisiana Department of Wildlife and Fisheries (LDWF) produces paddlefish fingerlings and releases more than 50,000 into the wild each year. Bobby Reed, LDWF inland fisheries biologist, is the manager of this project.

Timeline Summary of Paddlefish Management in Louisiana

- 1914 – First state to regulate paddlefish in United States with season closure and 12-inch minimum length
- 1950 – Established as a commercial fish with a 15-pound minimum size
- 1983 – Noticed excessive exploitation in early 1980s primarily by non-resident fishers
- 1986 – Louisiana Department of Wildlife and Fisheries commission responds with emergency closure in May; life history studies begins
- 1990 – Louisiana joins MICRA and assists in developing basin-wide management strategies for paddlefish
- 1991 – Louisiana becomes only the third state to successfully spawn paddlefish; implements state management and recovery plan
- 1992 – Permanent (Secretarial) closure goes into effect
- 1992 – Paddlefish listed as an Appendix II Species under CITES regulations
- 1993 – MICRA develops and publishes a strategic plan for the management of paddlefish in the Mississippi River basin
- 1995 – Paddlefish stock assessment study begins with 18 states participating
- 1998 – All Acipenseriformes listed as Appendix II Species under CITES
- 2000 – Stocked 10th year class of fingerlings into Toledo Bend, La.
- 2001 – Revision of MICRA paddlefish strategic plan; 22 states now participating
- 2002 – Paddlefish chosen as the native fish species for Native Fish in the Classroom Project
- 2004 – Stock assessments, spawning and recovery efforts continue

Reed 2004

AQUATIC INVASIVE SPECIES

Plants and animals living outside their natural geographic boundaries can be called by many names: exotic, introduced, nonindigenous, invasive, non-native and nuisance. Some of these organisms have been intentionally introduced by humans for reasons such as use in agriculture, the pet industry, and fish and wildlife management. Others have entered accidentally in ships' ballast waters, in packing materials, as hitchhikers on other plants and animals, or even in hurricanes. Because of its mild climate and geographical location, Louisiana is very susceptible to the introduction of a variety of nonindigenous plants and animals.

When nonindigenous species make their way into natural ecosystems, they can threaten native habitats and the organisms that live there. Once established, non-native species can displace native plants and animals, alter ecosystems, cause disease, and interfere with industry, agriculture and recreation.

Some aquatic nonindigenous species directly affect native populations of aquatic animals living in Louisiana waters by taking over habitat or directly competing for food sources. For example, some invasive fish have no natural predators, so their populations may flourish. Some freshwater invasive fish species from China and other parts of east Asia include the big head carp (*Hypophthalmichthys nobilis*), grass carp (*Ctenopharyngodon idella*), silver carp (*Hypophthalmichthys molitrix*) and black carp (*Mylopharyngodon piceus*).

These invasive carp species affect paddlefish several ways. Bighead carp and silver carp feed on zooplankton, competing with paddlefish for the same food sources. The silver and bighead carp also encroach paddlefish habitat.

The adult bighead carp weighs about 9 kilograms (19 pounds) and reaches 51 centimeters (20 inches) in length. It has irregular black blotches on its body as well as small scales. The body shape is distinctive with a short body length and large head. It is a filter feeder that eats plankton throughout the water column.



Bighead carp
(Photo courtesy USGS Florida
Caribbean Science Center)



Grass carp
(Photo courtesy USGS Florida
Caribbean Science Center)

The adult grass carp reaches a length of 127 centimeters (50 inches) and can weigh about 27 kilograms (60 pounds). Its coloring is dark bronze on the back with a silver belly. The scales are darkly colored on the edges, giving the fish a crosshatched appearance. Grass carp feed on soft aquatic vegetation.

The adult silver carp reaches 20 centimeters (47 inches) in length and can weigh about 9 kilograms (19 pounds). It is a silver-colored fish with a toothless, upturned mouth that has fused and sponge-like gillrakers. This fish feeds on plankton in the upper portion of the water column and prefers to inhabit impoundments or backwaters of large rivers.



Silver carp
(Photo courtesy L. Lovshin
U of Auburn and USGS NAS)



Black carp
(Photo by Leo G. Nico)

The black carp reaches 132 centimeters (52 inches) in length and weighs up to 68 kilograms (150 pounds). It is brownish-black in color with black-gray fins. The body shape is long and thin, and it has a mouth full of teeth made to crush prey. Found in large rivers and lakes, this fish prefers to inhabit the bottom portion of the water column, closer to its prey. The black carp eats snails, mussels, aquatic insects and crustaceans. It resembles the grass carp.

Another aquatic invasive species that may compete for or have an effect on the paddlefish food source is a mussel. The zebra mussel (*Dreissena polymorpha*) is a small filter feeder. Zebra mussels live in fresh water and have alternating dark and light bands on their 2-inch-long shell. They are known to take more food out of the water column than they can actually use. This action affects all filter feeders in the area by decreasing the amount of plankton in the water column.



Zebra mussel
(Photo courtesy
Ohio Sea Grant)

The nonindigenous species issue is very serious and costly. In Louisiana an Invasive Species Taskforce, an interagency partnership headed by LDWF, was formed to create a management plan for the state. The state management plan was completed in 2005.

FISHERIES MANAGEMENT

LDWF is the lead agency in the state to conserve and protect living renewable resources for present and future generations of Louisiana citizens. The mission of the Inland and Marine Fisheries Divisions is to conserve and protect aquatic resources by controlling their harvest and replenishing and enhancing fishery stocks and habitat.

The Inland Fisheries Division manages fish populations and habitats for the conservation and improvement of recreational and commercial fishing, primarily in freshwater areas of the state. These aquatic resources are managed to provide for the needs of consumptive and non-consumptive users and to maintain environmental health. This is accomplished by setting seasons, size and possession limits, gear restrictions, or other means of protecting key resources and replenishing and enhancing species and their habitats. Ongoing research provides insight into the proper functioning of natural systems, and public education programs promote wise use of these resources.

ROLE OF HATCHERIES

What is a hatchery?

A hatchery is a place where fish species such as bass, catfish, crappie and bluegill are hatched, raised and then stocked in waterways to enhance natural populations. Since 1997, the Booker Fowler Fish Hatchery in Forest Hill, La., has spawned paddlefish.

Why are hatcheries important?

Resource managers nationwide acknowledge hatcheries as valuable tools for the preservation of our nation's fish resources. Fish are stocked for several reasons. Some are stocked to enhance recreational fishing, others to restore native species to waters they formerly occupied.

The LDWF fish hatchery system has a rich history of fish production and research. Much of the technology used in modern catfish and striped bass aquaculture practices was developed in the department's hatchery facilities. Historically, the hatchery system functioned primarily as support for technical assistance to pond and small lake owners and for stocking new and renovated lakes with native species, predominately largemouth bass and bluegill.

The department's decision to begin the introduction of the Florida subspecies of the largemouth bass (*Micropterus salmoides-floridanus*) and the adoption of the Louisiana Black Bass Management Plan mandated a hatchery policy change. Today, Louisiana's hatcheries produce fish for bodies of water that have been damaged by habitat destruction or overuse, as well as stocking select lakes with popular sport fish.

LDWF operates four fish hatcheries. Beechwood Fish Hatchery, Monroe Fish Hatchery and Lacombe Fish Hatchery are older facilities constructed in the 1920s and 1930s. The newer Booker Fowler Fish Hatchery began fish production in the spring of 1997. Additionally, the Inland Fish Division operates an egg-taking facility at the Toledo Bend Research Station.

Booker Fowler Fish Hatchery

The Booker Fowler Fish Hatchery was built with federal disaster relief funds that were allocated to Louisiana due to damage to the Atchafalaya Basin in 1992 by Hurricane Andrew. Paddlefish populations were decimated; 100,000 fish were lost to this storm. The total cost to build this state-of-the-art facility was \$13 million. It is the largest fish hatchery in Louisiana and has been designated the department's primary fish production facility. The hatchery will produce all fry and provide most of the fingerling production for the state of Louisiana.

Hatcheries can be warm-, cool- or coldwater facilities. Booker Fowler Fish Hatchery is a warmwater station involved in spawning, hatching and rearing young fish (fingerlings). Fingerlings are raised to a size and age that provide them the best chance of survival in the wild. Louisiana's hatchery system supports the management schemes implemented by LDWF's inland fisheries biologists, providing them with healthy sport fish fingerlings to stock into Louisiana's public waters. Booker Fowler Fish Hatchery has artificially spawned paddlefish since 1997 and has produced 1.7 million fry and fingerlings.

The hatchery cannot provide paddlefish with all the environmental factors required to spawn naturally (see spawning section), therefore, paddlefish are artificially propagated in the hatchery. Wild paddlefish stock are collected because they are river inhabitants and do not respond well to living in hatchery ponds. In Louisiana, mature fish are collected from flooded tributaries in February. Once collected, paddlefish are transported in hauling trucks. At the hatchery, the fish are sexed, weighed and tagged. Next, the fish are injected with LH-RH hormone, which stimulates spawning. The female is given two hormone injections 24 hours prior to spawning to help the eggs ripen (become ready to be spawned). Males are given one injection to increase milt (sperm) production. The following morning, female paddlefish are examined for softened abdomens, which is a sign that eggs are mature. When eggs begin to flow from the vent of the female, artificial propagation begins.

Eggs can be removed from the female paddlefish in two ways: the female may undergo a Caesarean section, or she can be stripped of her eggs. During the Caesarean section procedure, the female is placed on a stretcher on her dorsal side (belly up) and kept irrigated via water running across her gills. A small incision is made on her abdomen, and the eggs are quickly removed. The incision is sutured; an antibiotic is administered; and the female is returned to the holding tank to recover. The advantage of this procedure is that more eggs are collected from the female. During the stripping procedure, the female is held by her rostrum while a small incision is made in the urogenital opening. Pressure is applied to the female's abdomen to force eggs out, and eggs are collected. The benefit of this process is that the female is out of the water for a shorter period of time, however, fewer eggs are collected. The female is then returned to her holding tank much faster to recover. After artificial propagation, females are usually held for about seven days to ensure survival before returning them to their collection site.

Through both procedures, eggs are handled in the same manner. They are collected in plastic tubs and kept moist, but relatively dry. Each egg has a small pore (ovipore) located on its surface, which will begin to close once it is inundated with water. Likewise, a sperm does not become active unless it comes in contact with water. Once all the eggs are collected from one particular female, milt is collected from several males in a separate container by applying

pressure to their abdomens. Eggs and sperm are then ready to be mixed. Adding water activates the sperm, which is then poured over the eggs. Fertilization begins when eggs start to clump together.

In the wild, paddlefish spawn over gravel beds. In Louisiana, they may use logjams or mussel beds. The eggs are naturally sticky and adhere to this substrate. However, in the hatchery, a clay mixture called fuller's earth is added to the fertilized eggs to prevent them from sticking together. The eggs are stirred continuously with a turkey feather for 30 minutes to make sure they are sufficiently coated with the clay. Eggs are placed in an incubation jar and tumbled against one another for aeration. Fuller's earth ensures that eggs do not adhere to one another, decreasing the possibility of fungal growth or improper aeration.

After sufficient mixing, eggs are rinsed free of fuller's earth mixture and placed in incubation jars. They hatch in five to seven days. Newly hatched fish, called fry, swim up and out of the incubation jars into water troughs known as raceways. Paddlefish fry will begin to eat a high-protein fish food five to six days after hatching. When fry become fingerlings about 3 centimeters (1 inch) in length, they are transferred to covered raceways outdoors. Covered raceways are used because paddlefish are sensitive to sunlight. At 12 to 15 weeks of age, paddlefish fingerlings are injected with a coded wire tag (CWT) and released into Louisiana river systems.

The timeline of paddlefish management in Louisiana:

- Late February – wild paddlefish stock are collected
- March (first week) – artificial propagation induced and wild stock is returned to collection site
- Early April – paddlefish fry are placed in covered raceways
- Late May to mid-June – paddlefish fingerlings are tagged with CWT and released to natural habitat

Interesting Facts

- The paddlefish was first described by Hernando de Soto during his 1542 exploration of the Mississippi River.
- Hurricane Andrew caused the death of 100,000 paddlefish in the rivers and lakes of Louisiana. The majority of the loss occurred in the Atchafalaya River basin.
- The Louisiana Department of Wildlife and Fisheries restocks the paddlefish population with more than 50,000 25.4-centimeter (10-inch) fingerlings each year.
- Paddlefish are among the largest freshwater fish in the United States.
- Considered a living fossil, the paddlefish dates back 400 million years.
- Like the shark, a paddlefish's skeleton is cartilaginous.
- Paddlefish are filter feeders.
- Paddlefish have smooth skin and few scales. The skin feels like a wet tire.
- The genus name for paddlefish, *Polyodon*, is Greek for "many teeth" and refers to the paddlefish's many diamond-shaped teeth in its fry stage. The species name, *spathula*, is Latin for "*spatula*" or "blade" and refers to the paddle-shaped rostrum of the fish.
- Common names of the paddlefish include: duckbill cat, Mississippi paddlefish, spadefish, spoonbill cat and spoonbill catfish.

Section 2

AQUARIUM SETUP AND MAINTENANCE

Equipment for Aquarium Setup and Maintenance

- **48-gallon circular re-circulating tank (including filtration system)**
- **Biological filter material** – can be made from plastic pan scrubbers, cut up straws, whiffle balls, bottle caps, biobeads and/or anything plastic with a lot of surface area for bacteria to grow on.
- **Incubation jar** – used to incubate eggs until hatching. (See directions on Page 29.)
- **Fry basket/nursery** – used to hold newly hatched fry until strong enough to swim throughout the tank. (See directions on Page 30.)
- **Air stones** – oxygenate the water.
- **Pipettes** – for moving eggs and small hatchlings and removing dead or fungal eggs.
- **Aquarium vacuum** – a long tube siphon, used when necessary to remove excess debris and dirty water from the tank.
- **Fritz Guard** – dechlorinator and conditioner used to remove chlorides and chloramines from tap water and help replenish the fishes' slime coat to prevent disease.
- **Nitrifying bacteria** – bacteria that feed on ammonia compounds (waste from food and fish). The presence of these bacteria clears water and reduces odor.
- **Fish nets** – used to remove live fish from bucket or tank.
- **Water quality test kits** – to test for ammonia compounds ($\text{NH}_3 / \text{NH}_4$), nitrates (NO_3) and nitrites (NO_2) and to measure pH levels. These water quality parameters need to be maintained at proper levels to prevent stress on fish. The test kit used is the TetraTest Laborett.
- **Fish food** – high-protein crumble, brand name Rangen (provided by hatchery), or live *Daphnia* spp. The high-protein crumble must be kept frozen.
- **Automatic feeder** – delivers the frequent feedings larval fish require. An automatic feeder such as the Sweeney vibratory feeder ensures fry and fingerling receive enough food.
- **Daphnia setup** – (optional) used to rear a *Daphnia* spp. colony. (See Page 33.)
- **E6000** – a strong adhesive used to seal leaks in the aquarium setup.

Aquarium Setup

- The aquarium should be set up at the beginning of the school year in order to support larval fish in the spring, the tank must run for a few months before acquiring paddlefish fry or eggs to allow time for nitrifying bacteria to establish.
- To check for leaks in your new tank or your empty tank that has been sitting over the summer months, fill the tank outdoors. Make sure that the lower ball valve is closed.
- If there is a leak, drain the tank, dry it and apply E6000 as needed. This should be done outdoors or in a well-ventilated area. Allow adhesive to cure for 24 to 72 hours.
- If the tank is leak free, fill it in the classroom.
- Plug in the air pump and make sure the air stone is new.
- Add the amount of Fritz Guard recommended in the instructions on the bottle to remove chlorine and to condition the water.
- Run the tank for several days, then add native fish such as *Gambusia* spp. or bluegill sunfish to help establish good bacteria colonies in the tank. The Booker Fowler Fish Hatchery can provide fish for this purpose.
- In two to three weeks, a brown slime coat will begin to cover the filter material – this is bacteria.
- This tank takes longer to set up than most because the temperature needs to remain low, ranging from 15°C to 18°C (60°F to 65°F) to allow proper hatching of paddlefish fry. When water temperatures are cooler, bacteria grow slower.

The aquarium has several major features:

- The tank is equipped with a double standpipe (a), which includes an internal and external standpipe. This allows water to be drawn from the bottom of the tank to the filters. To keep fry from entering the filter system, cover inner standpipe with a plastic canvas sleeve.
- In the first filter, water travels through the physical filter (b). Water comes in near the bottom of this filter, which traps large food particles or debris at the filter floss barrier (c).
- Water travels across to the second filter, the biological filter (d), where bacteria feed on organic compounds in the water, converting them to nonharmful compounds.
- Water then travels to the airlift (e), which pumps oxygenated water from the biological filter into the tank.
- The top of the airlift brings water back into the tank and should be angled (f) to encourage a circular flow of water.
- The process is then repeated. This is why it is called a re-circulating tank.

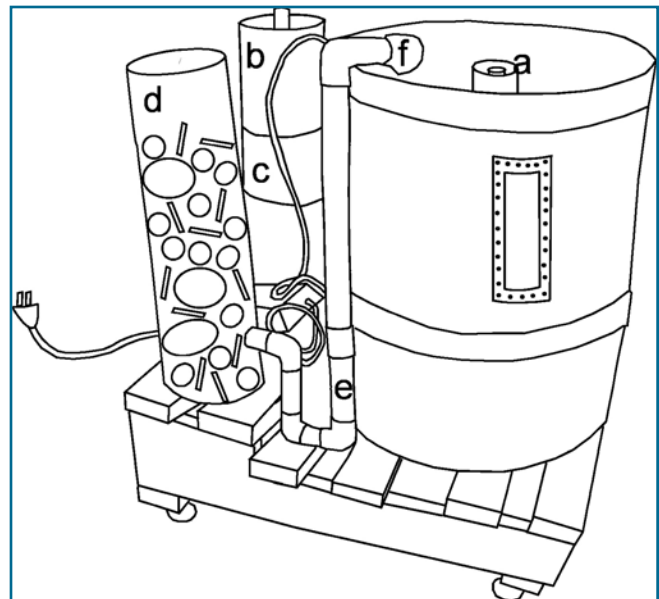

Logbook

The logbook will be used to monitor the development of paddlefish from eggs to fingerlings, water quality and other physical features and anomalies. See Appendix # V for a sample log. Take daily readings of temperature, pH, nitrate, nitrite, ammonia compounds and dissolved oxygen when the tank is first set up until water quality parameters do not fluctuate. Monitor water quality semiweekly (twice a week) after parameters become stable. Once eggs arrive, daily water quality testing should begin again. Continue daily monitoring through the first two weeks after fry start feeding. Once minimal fluctuation of water quality parameters is observed, then semiweekly readings may resume.

Water Quality Monitoring

Water quality must be maintained in order for the fish to survive and grow properly. Water should be tested daily for temperature, dissolved oxygen (DO), ammonia compounds (NH_3 or NH_4^+), nitrates (NO_3), nitrites (NO_2) and pH. For any water changes or additions, water must be dechlorinated before adding it to the tank. (See the next page for a diagram of the aquatic nitrogen cycle.)

Water Quality Parameter	What It Measures	Desired Range	Danger Reading – How Fish are Affected	Remedies
DO	Amount of oxygen in water	7 to 9 ppm	1 to 5 ppm causes respiratory stress. Zero ppm is an anoxic condition, and fish will die.	1) Change air stone every two weeks. 2) Check that water level in biological filter is high enough to allow airlift to pump water sufficiently.
pH	Acidity or alkalinity of water	6.5 to 8.5	Less than 4.5 or higher than 11 is fatal to fish.	1) Change 50% of water. ($11 < \text{pH} < 4.5$) 2) Add $\frac{1}{4}$ cup baking soda. ($\text{pH} < 4.5$)
NO_2	Partially decomposed material in water	0 to 1 ppm	Above 1 ppm leaves fish more susceptible to bacterial and viral infections.	1) Change 50% of water. 2) Add nitrifying bacteria. 3) Add zeolite or other ammonia reducer if levels do not decrease.
NO_3	Decomposed material in water	0 to 10 ppm	At above 10 ppm prolonged exposure will decrease fish's osmoregulation.	1) Change 50% of water. 2) Add nitrifying bacteria.
NH_3 or NH_4^+	Amount of waste in water	Less than 0.06 ppm	Increases as pH increases; 0.06 to 0.2 ppm damages gills, eventually killing fish.	1) Change 50% of water. 2) Add nitrifying bacteria. 3) Add zeolite or other ammonia reducer if levels do not decrease.
Temperature	Average amount of heat in water	Eggs: 15° C to 18° C (60° F to 65° F) Fry/fingerlings: 17° C to 22° C (63° to 72° F)	Eggs: above 18° C (65° F) fungus growth increases and hatching is premature. Fry: above 22° C (72° F) more susceptible to disease.	Prepare gallon jugs with dechlorinated water and place in freezer. If water is too warm, place frozen jugs in tank until water cools. Keep air temperature about 17° C (63° F).

Aquatic Nitrogen Cycle:

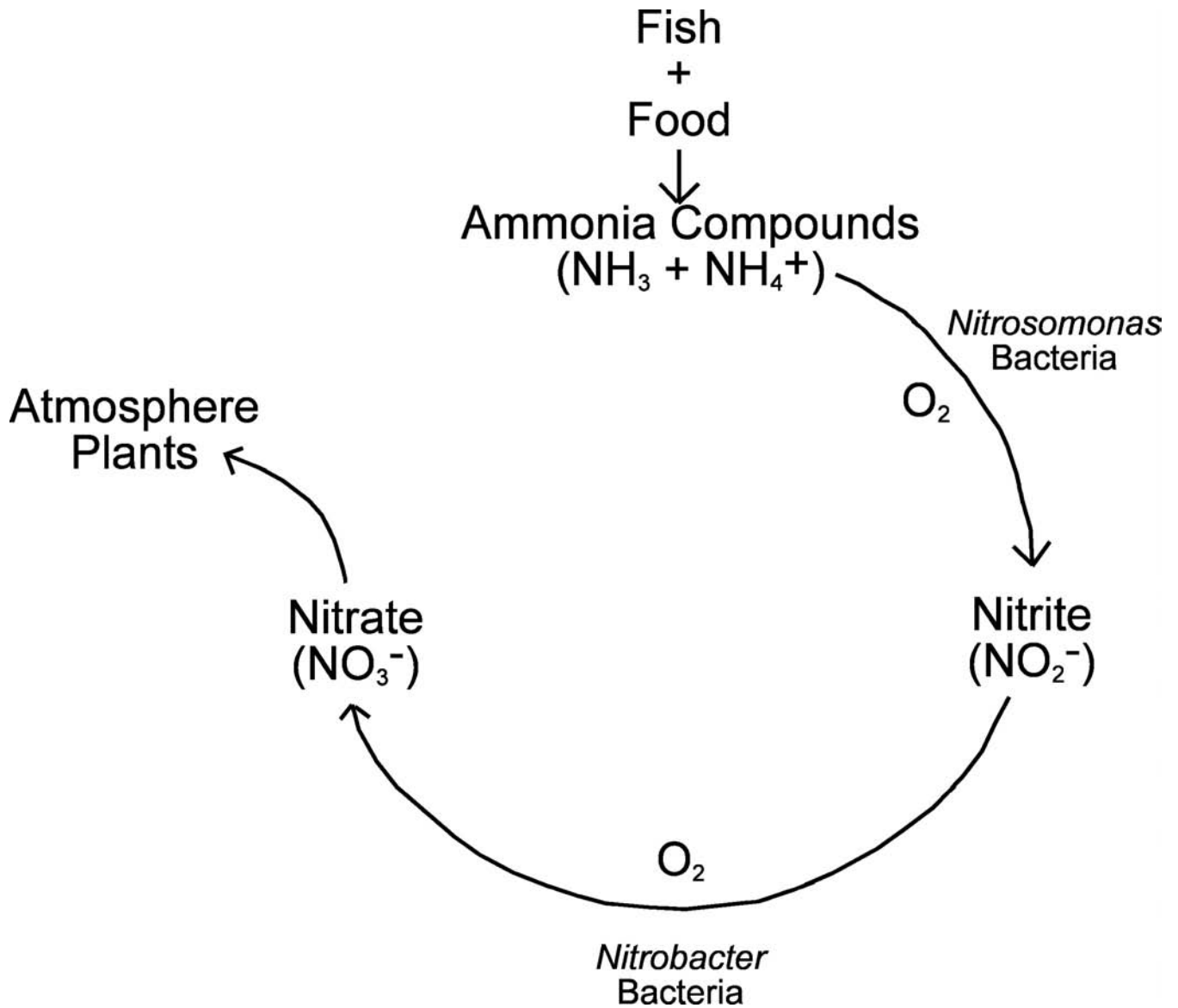

How to Change the Water

There is no need to change the water in the tank unless uneaten food is collecting on the bottom or water quality parameters are far outside the desired ranges. If these conditions occur, use the aquarium vacuum to remove water from the tank.

Vacuumping

- To vacuum the tank, fill the tube with water by submerging the wide end of the vacuum first. Slowly submerge the rest of the tubing, making sure there are no air bubbles in the tubing of the vacuum.
- While all the tubing is under water, place your thumb over the small end of the tube to make a tight seal. With your other hand, grasp the large end so that its opening is near the bottom of the tank and away from the paddlefish fry.
- Next, remove the small end of the tube from the water while holding your thumb tightly sealed over the opening and place this end into a bucket. Release your thumb. Water will now run from the tank into the bucket.
- Move the wide end of the tube along the bottom of the tank to vacuum food and dead fry.
- Once the bucket is almost filled with water, pull the wide end out of the tank and let the remaining water flow into the bucket.
- Fresh water must be dechlorinated before adding it to the tank.

Incubation Jar Setup

Note: Before receiving paddlefish eggs, remove any fish that were previously occupying the tank and place them in a separate aquarium.

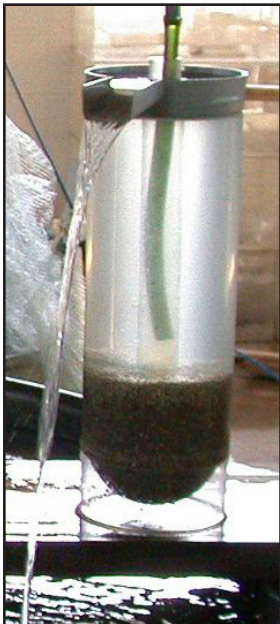

McDonald Hatching Jar
(Photo by Jan Dean)

The incubation jar is designed to mimic the McDonald hatching jars used by state hatcheries. The incubation jar apparatus is made out of a plastic pitcher that narrows at the bottom, a small water pump, about 5 feet of 1/4-inch vinyl tubing and a glass funnel. The funnel must be glass because a plastic funnel will float up from the bottom of the pitcher.

- To set up the incubation jar, dip the pitcher into the tank and fill it with water.
- Place the pitcher handle over the side of the tank and position a piece of foam or wood between the pitcher and the outside of the tank to keep the pitcher from resting at an angle. Secure the foam or wood to the pitcher handle with duct tape.
- Attach the vinyl tubing to the water pump. Make sure that the correct size adapter is attached to the opening of the air pump to fit the 1/4-inch tubing. It may be necessary to heat the end of the tubing to make it more pliable to stretch over the water pump fitting.

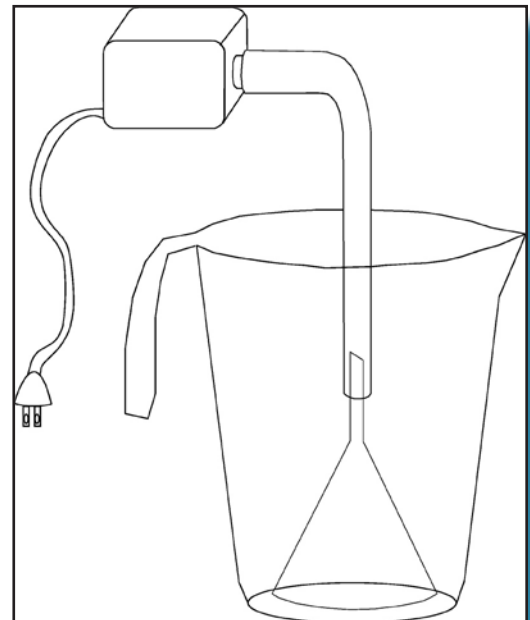

- Carefully attach the vinyl tubing to the glass funnel. Heat the end of the tubing if necessary to stretch the tubing over the funnel. Always be careful when using glass.
- Once the tubing is attached to the water pump and funnel, place the wide end of the funnel down into the pitcher. (See diagram, Page 29.) Next, place the water pump inside the biological filter or tank, about one foot from the top.
- Plug in the water pump, and water will begin to circulate in the pitcher.
- Add eggs to the incubation jar. Gently pour eggs from the plastic bag into the pitcher.
- Make adjustments to the speed of the air pump so eggs gently tumble. If the eggs are whirling rapidly in the incubation jar, the larval fry developing inside the eggs may suffer spinal cord damage and die.
- Remove the incubation jar once eggs are hatched.

Fry Basket/Nursery Setup

The fry basket will be used for newly hatched fry. They will swim out of the spout of the incubation jar into the fry basket after hatching.

Materials needed to build fry basket/nursery:

- 3 pieces of No.10-point mesh plastic canvas
- colored monofilament line
- scissors
- E6000 adhesive
- marker
- large embroidery needle

1. Place two pieces of No.10-point mesh plastic canvas together so that they overlap by two rows of mesh holes.
2. Thread the monofilament line through the embroidery needle and sew the pieces of plastic canvas together.
3. After the two pieces are sewn together, bend the ends towards each other to form a cylinder.
4. Repeat steps 1 and 2 on the open side of the cylinder.

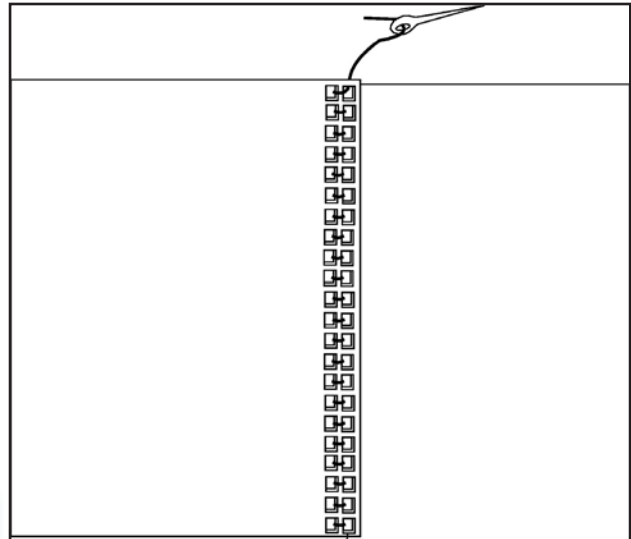
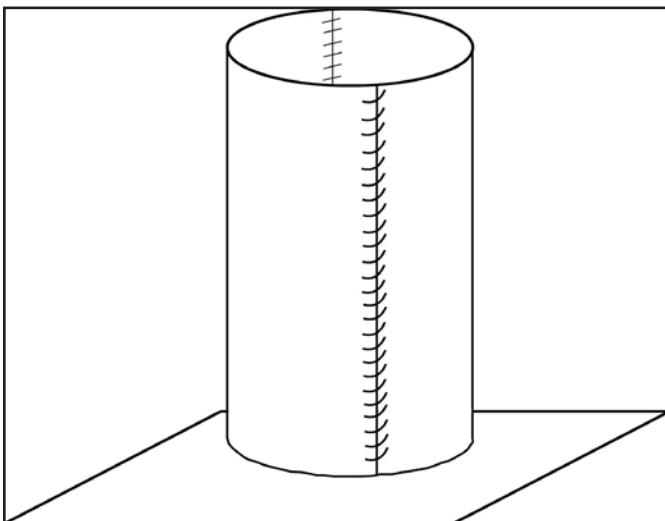

5. Place the cylinder of plastic canvas on top of the third piece of plastic canvas.
6. Place a bead line of E6000 adhesive along the seam inside and outside of the plastic canvas base. Smooth out the bead line of adhesive. Place the cylinder of plastic canvas with the glued side up to dry.

7. Once the adhesive has dried, use scissors to cut away excess plastic canvas.
8. On the open end of the basket, cut a triangular shaped notch to allow the basket/nursery to fit flush against the incubation jar.
9. Now the basket is ready to use.
10. Evenly attach four 1-foot lengths of monofilament to the open end of the basket. These pieces will be tied together and used to hang the basket/nursery from a dowel or yardstick across the top of the tank.
11. Place a dowel or yardstick across the top of the tank.
12. Make sure the side with the triangular cutout is lined up with the spout on the incubation jar. Now, attach the monofilament line to the dowel or yardstick.

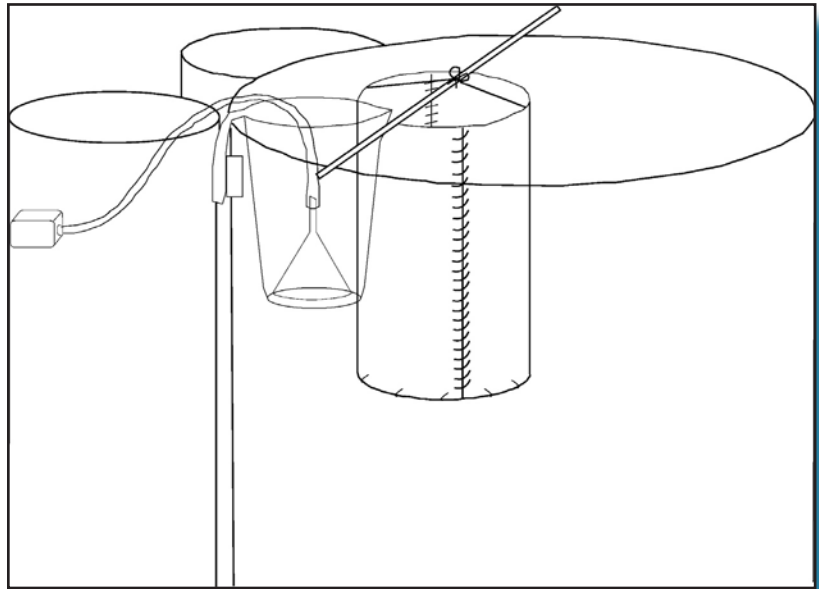

The fry will remain in the basket/nursery for more than a week. This will give the young fish time to learn to swim and absorb their yolk sacs.

While fry are in the basket/nursery, food can be introduced. If food gets stuck in the mesh holes and starts to accumulate, gently move the basket up and down and the food will be released.

The fry will be ready to be released from the basket/nursery when their yolk sacs are completely absorbed and they are swimming freely. When fry have been released from the nursery basket, remove the basket, clean and store the equipment for next year.

Feeding

Fry will be eating an artificial food source, Rangen, which is a hatchery fish food. The fish food contains 40 to 45 percent protein and is manufactured in several sizes (0 to 2). *Daphnia* spp. can be supplemented into the fishes' diet. (See section on maintaining a *Daphnia* spp. colony.)

Rangen is perishable and must be stored in a freezer. It should be discarded after three months. Never use food from the previous year. Old food has a significantly lower nutritional value and will leave fish susceptible to disease. For example, vitamin C in the feed will decrease by 80 percent in seven months.

Feeding should start about five days after hatching. This is when the fry lose their gut plug and have used up their nourishing yolk sac. Carefully watch your newly hatched fry to look for any that have very little yolk sac left. Once the first few start to have a very small yolk sac, it is time to introduce food into the tank. When the fry start to eat, expect a large die off because some fry cannot adapt to the artificial food source.

When introducing food, sprinkle a pinch of crumble inside the nursery basket. A large salt shaker is an effective way to deliver smaller amounts of food evenly across the water surface. This can be done several times a day to introduce fry to the feed. Once fry feeding behavior is noticed, it is time to use the automatic feeder.

Start with the smallest crumble (size 0). When the fry are about 1 inch in length start mixing in the larger crumble (size 1). Once all fish have reached that length, use only size 1.

How to Use the Automatic Feeder

There are three parts to the Sweeney vibratory feeder: food dispenser, display pad and control box.

The food dispenser is attached to the display pad, and the display pad is attached to the control box. The control box is plugged into the wall.

The food dispenser will hang over the tank on a swivel apparatus made of two “U”-shaped brackets, 71 inches of 1-inch diameter PVC piping, a PVC “T” coupling and four wood screws. Use a PVC cutter or saw to cut the PVC into two segments – one 22 inches and the other 49 inches long. See photo below for assembly.

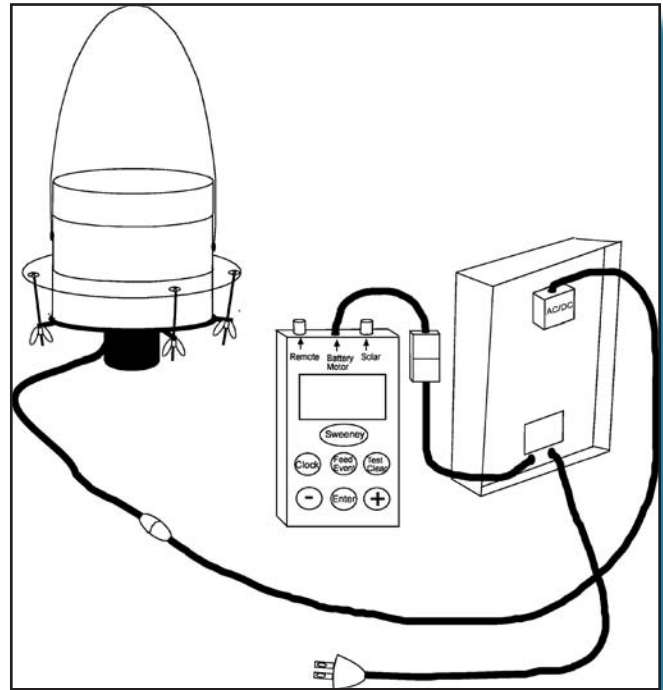

Tank with food dispenser on swivel apparatus
(Photo courtesy Kathleen Nichols)

The blue cap on top of the dispenser can be removed to add food.

The butterfly screws (wingnuts) on the bottom of the dispenser adjust to increase or decrease the amount of food that is released at each feeding.

Use the display pad to set the clock. The feeder can handle up to 24 feedings per day.

Set the display to release food each day at a speed of 10, for a duration of two seconds every four hours. As the fish grow, increase the duration to three seconds every four hours.

Before the fish are ready to feed, make sure that the timer is working. Set the timer and release feed over a bucket. If the feeder is not working properly and you have double-checked the settings, call the manufacturer, Sweeney, for help at (800) 443-4244.

Watch the location of your feeder to avoid dropping food into the external standpipe.

Double-check the settings on the timer to ensure that the proper amount of food is added to the tank. Excessive feeding will cause water quality problems in the tank.

If the power goes out or the timer is unplugged, the settings for feedings will not be affected unless they are deleted. The clock will go out and must be reset.

Tips to keep the automatic feeder functioning:

- Always properly secure the lid on your feeder by carefully fitting the studs into the holes. If water gets into the feeder, it will make the food clump together and will require extensive cleaning.
- Do not use the **Test/Clear** button on the timer to excessively disperse feed, as this may delete your programmed feed events.
- When setting a feed event on your timer, make sure that each field (time, duration and speed) are set with valid entries. Partially set feed events will prevent the timer from functioning properly. If you are uncertain how to set your timer, refer to the directions on the back of the timer or call a program manager.
- Only use Rangen fish feed from LDWF.

Daphnia spp. Setup (optional)

Daphnia spp. are small crustaceans that live in fresh water and are commonly known as “water fleas.” *Daphnia* spp. live about one month and will reproduce about every three days. It can be difficult to start a colony of *Daphnia* spp., but once a colony has formed, it is very easy to maintain.

To start a *Daphnia* spp. colony you will need:

- Culture of *Daphnia* spp. (See lesson entitled “Pass the Water Fleas, Please” for information on where to obtain *Daphnia* spp.)
- Hard water
- Clean, clear container such as a 3-liter bottle or a small tank (5 to 10 gallons)
- High-protein fish food pellets
- A garbage can with a lid (great way to store extra water, in case of water changes)

1. Add water and a few pellets of food to the container and let it sit for at least 10 days.
2. Add *Daphnia* spp. and place the container in an area with indirect sunlight (near a window or light). *Daphnia* spp. need eight hours of light a day.
3. The container can be aerated, though *Daphnia* spp. will grow fine without extra air as long as they are not overfed.
4. For larger populations and more frequent feedings, aeration with large bubbles at a slow rate is best.
5. Place one pellet of high-protein fish food in the container. Once the pellet dissolves, add another. It may take up to one week for a pellet to dissolve.
6. Change water no more than once every three weeks. Up to 50 percent of the water can be changed at once. Use only aged (10-day-old) water. Remember, slightly dirty containers grow the best *Daphnia* spp.

Problem Solving

What to do if ...

- **The aquarium water is cloudy and smelly.**

The water may turn cloudy as nitrifying bacteria begin to multiply in the tank in response to an increased nutrient load. Once paddlefish begin to feed, there will be increased waste from the fish and uneaten food that may start to decay. Bacteria will multiply to keep up with the demand, however, before they become sessile (attach to a substrate, such as biobeads), they will float, causing water in the tank to look cloudy. Once bacteria attach to a substrate, the water will clear up. It is imperative that the tank is set up and running at the beginning of the school year. This will allow for the biological filter to be seeded properly with nitrifying bacteria and prevent water quality problems once paddlefish are introduced.

If the water turns cloudy when paddlefish are introduced, make sure that all water quality parameters are within the normal range. If water testing shows normal levels, nothing further needs to be done, and the water should clear up in a few days. If water testing shows abnormal levels, see the water quality monitoring section (Page # 27) for remedies.

- **There is not enough water flow from the airlift.**

The airlift may not be working for several reasons:

- a. The air stone may be broken or clogged with brown algae. Make sure that the air stone is replaced about every two weeks. A clogged air stone can be cleaned and reused. Throw away broken air stones.
- b. The tank does not have enough water in it. Water will evaporate from the tank. Check the water level in the tank by observing the level of water in the biological filter. If the biological filter is low on water, this will slow down the amount of water that the airlift is able to pump into the tank. Remember to add only dechlorinated water.
- c. The air pump may not be working properly and may need to be replaced. Remove the air pump, hook it up to another water source and observe if it is aerating properly. If not working, replace the air pump.

- **The filters are turning brown. Should they be cleaned?**

The filters will turn brown as food particles and other debris begin to collect in the physical and biological filter. There is no need to clean the filters unless water flow is impeded from one filter to the other. If there is an excessive buildup of debris in the physical filter, simply remove the floss pads and rinse with water. NEVER WASH ANY FILTER MATERIALS WITH SOAP OR DETERGENTS OF ANY KIND. THIS WILL KILL FISH! It is normal for the biological filter to turn brown as bacteria build up on the substrate, biobeads or other materials in the filter. Never wash or rinse the substrate or biological filter materials. This will destroy beneficial bacteria that drive the nitrogen cycle in the tank.

- **What if the eggs start to grow fungus?**

There are several reasons why fungus may begin to grow on paddlefish eggs:

- a. The water temperature is over 18°C (65°F). Increased water temperatures will encourage fungal growth and kill paddlefish eggs.
- b. The eggs are dead. This occurs in the hatchery system, also. Eggs die and fungus begins to grow.

- c. Eggs are not tumbling enough in the incubation jar. Eggs that come in contact with each other may start to stick together. Contact promotes fungal growth. Remember, eggs should gently tumble around in the incubation jar.
In all cases, eggs with fungus will not hatch, so remove them immediately from the tank to prevent a fungal egg from spreading fungus to a healthy egg.

- **The ammonia level is above 0.06 ppm.**

Ammonia level is the most critical water quality parameter to monitor. Ammonia levels are safe below 0.06 parts per million (ppm). Larval fish are extremely susceptible to increased ammonia levels. Fish gills can be damaged when ammonia levels reach 0.1 ppm to 0.2 ppm. High ammonia levels are accompanied by high pH levels, due to the amount of hydroxide ions in the tank. So, if the pH is increasing, make sure that ammonia levels are monitored closely.

Increased ammonia levels are caused by insufficient numbers of nitrifying bacteria in the tank. Ammonia is a by product of fish waste and uneaten, decaying fish food. Nitrifying bacteria consume waste products and keep ammonia levels at a normal level.

IMPORTANT: The tank must be set up early. If the tank is not allowed to run for a few months before acquiring paddlefish fry, nitrifying bacteria will not have had enough time to become established in the tank.

To decrease ammonia levels:

1. Change 50 percent of the water, and then check the ammonia level.
2. Add nitrifying bacteria to the tank. Remove filter floss in the physical filter for one day to prevent new bacteria from attaching to this substrate. Replace the filter floss the next day.
3. If the ammonia level is still high, add zeolite (or other ammonia reducer) to the tank.
4. More water changes may be necessary. Repeat steps above.

TIP: If the tank is allowed to run for several months before paddlefish eggs are acquired, water changes should not be necessary.

- **How do I know if I am overfeeding?**

Overfeeding occurs when fish are given more food than they can eat. It can lead to increased ammonia levels. Signs of overfeeding include food accumulating on the bottom of the tank and fungal growth.

The amount of food released into the tank is directly proportional to the space where the food is shaken out of the automatic feeder. To decrease the volume of food dispensed, either decrease the size of the opening on the dispenser by turning the butterfly screws clockwise, or reset the timer on the automatic feeder for a shorter duration.

- **How do I set my timer on the automatic feeder?**

The feeder can handle up to 24 feedings per day. Use the display pad to set the clock. Set the display to release food each day for duration of two seconds every four hours at speed 10.

Setting the clock:

Press the **CLOCK** button and hold. The **HOUR** will flash. Use the **+** and **-** buttons to find the desired hour. To set, press **ENTER**. Use the **+** and **-** buttons to find the desired **MINUTES**. To set, press **ENTER**.

Setting the automatic feeding events:

1. Press and hold the **FEED EVENT** button until the number flashes. Use the **+** and **-** buttons to assign the first feeding, **1**. Press **ENTER** and wait.
2. The **HOUR** will flash, use **+** and **-** buttons to select the hour of the first feeding. Include **A.M.** or **P.M.** Press **ENTER** and wait.
3. The **MINUTES** will flash, use **+** and **-** buttons to select the minutes of the first feeding. Press **ENTER** and wait.
4. **DURATION** will now flash. Select **two seconds** for the duration of the feeding using the **+** and **-** buttons. Press **ENTER** and wait.
5. In the same spot on the display, **SPEED** will flash. Set the speed using the **+** and **-** buttons to **FS** (full speed). It is speed **10**, the lowest setting. Press **ENTER**.
6. Repeat the process for five more feeding events starting four hours after the first feeding event time. Remember to increase the **FEED EVENT** number each time.
7. To check your setting, press **FEED EVENT**. When **1** flashes, press **+** or **-** to check the next setting. Repeat to double-check that all feeding events are accurately set.
8. To set **TEST**, press **FEED EVENT**. Use the **-** to select **0**. Next, select the **DURATION** of **two seconds** and **FS SPEED**. Press **ENTER**. The test feature is now set, and each time it is pressed, feed will be released.

Double-check the settings on the timer to ensure that too much food is not added to the tank. Excessive feeding will increase water quality problems in the tank.

If the power goes out, or the timer is unplugged, the setting for feedings should not be affected, however, the clock will go out and must be reset.

• **When should I start feeding the fish?**

Test the automatic feeder well in advance of receiving paddlefish. This will allow the user to become familiar with the apparatus and determine if the feeder is working properly. A broken feeder can lead to starvation of fry. Start to introduce a small pinch of food to the nursery/fry basket when the first fry are about 3 days old. This will get the fish accustomed to the presence of food in the water.

Feeding behavior is easy to observe. Fry swim constantly, usually in a straight manner. When food is introduced, the fry will swim through the food, detect the food, turn and zigzag or swim in circles through the food. Once feeding behavior is noticed, the automatic feeder should be set up immediately and set for regular around-the-clock feedings.

- **What if the pH is too high (above 8.2) or too low (below 6.5)?**

The pH measurement is one of the most common water quality tests performed. Although pH indicates the sample's acidity or alkalinity, it is a measurement of the hydrogen and hydroxide ions found in a substance.

The pH scale ranges from a value of 0 to 14. A substance with pH lower than 7 is an acid and has a high concentration of hydrogen ions. A substance with pH higher than 7 is a base and has a high concentration of hydroxide ions.

An optimal pH range is 6.5 to 8.2 for most fish reproduction and development. Generally, fish cannot live in a pH below 4 or above 11. These extreme pH levels may affect body functions (physiology) of aquatic organisms making it very important to maintain pH levels in the aquarium. When troubleshooting water quality problems, such as pH, test the tap water. Hard tap water in some areas may be slightly alkaline because it may contain elevated levels of calcium carbonate and dissolved carbon dioxide. Because the pH of hard tap water ranges from 7.0 to 8.5 the water may need to be monitored more frequently.

The pH of a tank may decrease (become more acidic) due to fish, algae and plants releasing carbon dioxide (CO₂). Another reason pH may decrease is from the release of hydrogen ions caused by the reduction of ammonia during the nitrogen cycle. If the pH in the tank is below 6.5, the pH can be corrected by adding baking soda (sodium bicarbonate). Baking soda contains pH-stabilizing carbonates. These carbonate molecules can freely give or take hydrogen ions.

Increasing pH:

Begin by dissolving two teaspoons of baking soda in a large beaker filled with tank water. Pour this solution into the tank. Retest the water in two hours. If the pH is still low, wait 24 hours before adding more baking soda. Baking soda should be added in small amounts to increase pH because the fish are acclimated to the lower pH level. Most likely the pH gradually became more acidic; therefore, in order for the fish to safely acclimate, pH should be gradually raised no more than one pH unit per day.

The following day, test the pH again. If it still remains below 7.0, add more baking soda – the exact amount is up to your discretion. For instance, if the pH is 6.5, adding two more teaspoons of baking soda will increase the pH too much. Therefore, baking soda may need to be added in smaller increments than a teaspoon. It may take several days to adjust the pH back to an optimal range.

Decreasing pH:

If the pH of the tank is too high (above 8.5), test the ammonia level in the tank. If the ammonia level is above 0.1 ppm to 0.2 ppm a water change will be required. Refer to the problem solving section, "The Ammonia level is above 0.06 ppm." on Page # 29 for details on how change the water.

Section 3

APPENDICES

I. Lesson Plans.....	A1
Water Quality	
My Fish Ride a (Nitrogen) Cycle	
Do You Believe in pH Magic?	
General Information on Paddlefish	
Snagging Paddlefish Information	
Critical Conditions for Paddlefish Spawning	
How Old is that Fish?	
Effects on Paddlefish Populations	
Extirpated? Don't you Mean Extinct?	
What a Nuisance!	
Do Dams Affect the Paddlefish Population?	
Paddlefish Growth, Development and Behavior	
How Fast Do Paddlefish Grow?	
Comparing Eggs and Embryos	
Life Cycles of the Wet and Wiggly	
Pass the Water Fleas, Please	
II. References.....	A119
III. Louisiana Learning Standards and Grade Level Expectations Matrix for Lesson Plans and Definitions of Louisiana Learning Standards.....	A131
IV. Glossary.....	A139
V. Paddlefish Status Chart, Fry Diagram, Aquatic Hours Sheet and Water Quality Monitoring Log.....	A143

Lyn Murphy
Tioga Junior High
Tioga, La.

Grade Level
Middle School (6-8)

Duration
Two months
(approximately five minutes daily)

Subject Areas
Environmental Science
Chemistry

Materials List

- **Tetratest kits** (ammonia and nitrites)
- Safety goggles
- Turkey baster (for water samples)
- Computer with graphing software (MS Excel)
- Data sheets BM #4 and 5
- PowerPoint presentation to introduce the subject "My Fish Ride a Cycle"
- Native fish tank
- *Gambusia* sp. (or other small native fish)
- Timer (or clock)

Grade/Benchmark/GLE Science
7/SE-M-A7/41
HS/ESS-H-B1/13 (earth and space)

BM = Blackline Master

My Fish Ride a (Nitrogen) Cycle



1 of 10

Focus/Overview:

Students will investigate the nitrogen cycle by testing the water in a newly set up (with fish) aquarium. As the fish eat and produce nitrogenous wastes (nitrite and ammonia), students will discover the changes in nitrite and ammonia levels that occur as the biological filter is established and the *Nitrosomonas* spp. and *Nitrobacter* spp. bacteria colonies begin to convert the nitrites and ammonia to the less-toxic nitrates. Students will test daily for approximately two months or until nitrites and ammonia levels have decreased. They will graph their results and analyze the data to predict trends.

Background Information:

Please refer to BM #1.

Learning Objectives:

Students will:

- Investigate the nitrogen cycle as they monitor nitrogen and ammonia levels of the aquarium.
- Use evidence to make inferences and predict trends.
- Compare their findings to typical illustrations of the nitrogen cycle in science texts.

Procedure:

1. Attention-grabber. Ask students how many have had an aquarium and how many have had difficulties maintaining healthy fish. Explain that one of the problems in an aquarium is a high level of ammonia, which is toxic to fish. Show students the PowerPoint presentation.
2. Testing instructions. Demonstrate the procedure for testing the water. Point out the testing instruction sheets for nitrites (BM #2) and ammonia (BM #3), which will be posted near the fish tank. Make a testing schedule that assures all students will participate in testing the water. Have students record data in their own notebooks (BM #4 and #5) and on the classroom data sheet.



- Students begin testing as soon as fish are added to the water. *Gambusia* sp. or other small native fish will be used.
- Testing continues until nitrite and ammonia levels have dropped.
- Students will use their data, either on graph paper or on the computer using Excel, to graph their results.

Example Graph:

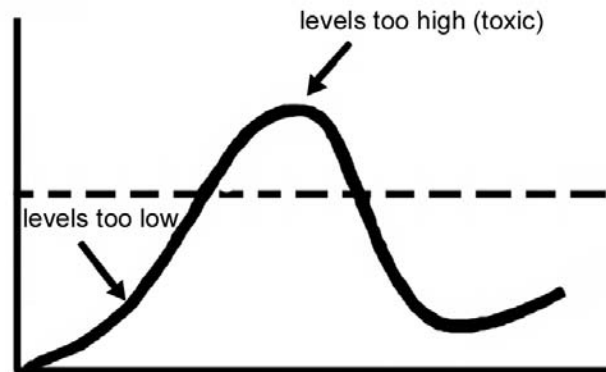

- Students will analyze the data they have collected to infer why ammonia and nitrite levels have dropped. The teacher will lead a discussion, asking students to explain why this is important to do before the paddlefish eggs arrive.

Assessment:

- Students will draw their fish tank nitrogen cycle, comparing the results of what they observe a land version of the nitrogen cycle.

Extension:

- Students test for nitrates, as well as ammonia and nitrites. They add plants to the tank and then test whether the presence of plants changes the nitrate level over the course of several days.



Blackline Master #2

How to Test for Nitrites (NO_2^-)

Materials Needed:

Safety goggles
Tetratest test kit (nitrite)
Test vial with stopper
Turkey baster
Reagent bottle 1
Reagent bottle 2
Tetratest color chart

Be sure to follow all instructions carefully!

1. Put on safety goggles.
2. Use the turkey baster to draw a sample of water from the native fish tank.
3. Rinse the test vial with the water to be tested. Empty the rinse water into the sink, not the fish tank!
4. Fill the test vial to the 5-ml mark with water to be tested.
5. Hold reagent bottle 1 upside-down (important!) while adding seven drops to the test vial.
6. Let the vial stand for 10 seconds, then add seven drops from reagent bottle 2.
(Hold reagent bottle 2 upside-down while adding.)
7. Cap and shake the vial gently.
8. Allow five minutes for the development of the color.
9. Hold the vial and the color scale vertically and match the color of the test solution with the closest color on the chart.
10. Record the value of the nitrite level on the class data sheet and on your own data sheet.
11. Empty the test solution into the sink.
12. Rinse the test vial with tap water.



Blackline Master #3

How to Test for Ammonia (NH_3/NH_4)

Materials needed:

Safety goggles
Tetratest test kit
Test vial with stopper
Turkey baster
Reagent bottle 1
Reagent bottle 2
Reagent bottle 3
Tetratest ammonia test color chart

Be sure to follow all instructions carefully!

1. Put on safety goggles.
2. Use the turkey baster to draw a sample of water from the native fish tank.
3. Rinse the test vial with the water to be tested. Empty the rinse water into the sink, not the fish tank!
4. Fill the test vial to the 5-ml mark with water to be tested.
5. Hold reagent bottle 1 upside-down (important!) while adding 14 drops to the test vial.
6. Close and shake the vial gently.
7. Open the vial, hold reagent bottle 2 upside-down while adding seven drops to the test vial.
8. Close and shake the vial gently.
9. Open the vial, hold reagent bottle 3 upside-down while adding seven drops to the test vial.
10. Close and shake gently.
11. Set the timer for 20 minutes. Wait 20 minutes for the development of the color.
12. Hold the vial and the color scale vertically and match the color of the test solution with the closest color on the color scale. Read the value of the ammonia level and record it on your data sheet and the class data sheet.
13. Pour test solution into the sink, and rinse the vial with tap water.

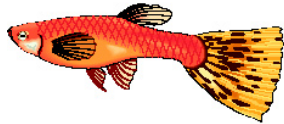

My Fish Ride a Cycle

The Nitrogen Cycle, That Is!

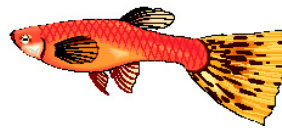

Have you ever had an aquarium where the fish were sad?

The water was bad?



Listen to a fishy story...

Hi, I'm Gus, the guppy.
I've got something to tell you.



You see, we fish are always surrounded by water.
(I know, you knew that!)

We get our food and our oxygen in the water.

But, it's also our toilet.
(Yuck! Would you like to live in your toilet?)

Things can get pretty icky, since we can't flush!



In rivers and lakes, that's not a problem.
They're bigger and rain helps dilute our waste.

In an aquarium, there's no place for the waste
to go.

Some really poisonous stuff starts showing up
in our water - nitrites and ammonia.

We can't live in that!

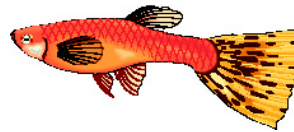

So what can you do to keep me healthy?

Change some of the water.
(Hey, I liked some of that water!)

Add chemicals. (Who's paying for that?)

Let some friendly bacteria do the work.
(Hey, I like that, too! Put someone else to
work!)

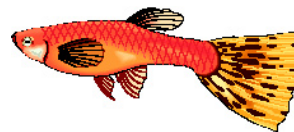

So, here's what you can do to see how friendly bacteria can
get to work:

•First, the tank will be set up (all 45 gallons of water). Use
bio-beads and bottlecaps in the filter.

•Make sure that all the chlorine is gone.

•Add lots of little fish like Gambusia sp.
Feed your fish.

•Test the water every day for nitrites and ammonia.

•Record your results.





After about two months, graph your test results.

Be prepared to discuss as a class what has happened to the nitrites and the ammonia levels.

Also discuss the appearance of the water and the filter.

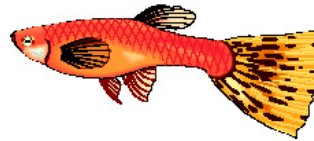

And, one last question from me, Gus,
"Are your fish happy and healthy?"

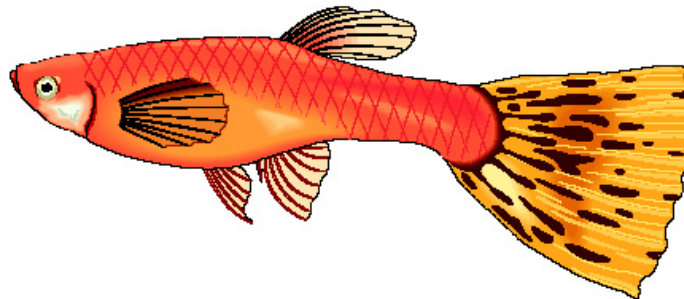

Kathleen Nichols
DeRidder Jr. High
DeRidder, La.

Grade Level
Middle School (6-8)

Duration
Two to three 45-minute
class periods

Subject Area
Inquiry
Physical Science

Materials List

- Cabbage water indicator (BM #1)
- 3 clear cups
- Baking soda
- Vinegar
- Distilled water
- pH diagram (BM #2)
- One set of H⁺ and OH⁻ cards (BM #3)
- The pH Scale (BM #4)
- 5 unknown substances (lemon juice or vinegar, distilled water, ammonia, soft drink, baking soda solution)

Per group:

- 5 clear cups
- Graduated cylinder
- 6 disposable pipettes
- 5 spoons
- Distilled water
- Data table (BM #5)

Grade/Benchmark/GLE Science
6-8/SI-M-A3/7
6-8/SI-M-A5/14-16
6-8/SI-M-A8/23
6-8/SI-M-B4/33
PS-M-A3
HS/PS-H-A1/2 (phys sci)
HS/PS-H-D2/23 (phys sci)
HS/PS-H-D2/33 (chemistry)

BM = Blackline Master

Do You Believe in pH Magic?



1 of 13

Focus/Overview:

The purpose of this lesson is to introduce pH and what it measures. Students will determine the difference between an acid and a base by conducting a simple experiment using cabbage water indicator.

Note: This lesson assumes students understand the term ion.

Background Information:

The determination of the pH of a substance is the measurement of the hydrogen ions (H⁺) found in that substance. The concentration of hydrogen ions is expressed in terms of the pH scale with values ranging from 0-14. Pure deionized water has a pH of 7, which is neutral. This means the level of hydrogen ions (H⁺) and hydroxide ions (OH⁻) in pure water are equal.

If the pH is lower than 7, the substance is an acid and has a higher concentration of hydrogen ions. If the pH is higher than 7, the substance is a base and has a lower concentration of hydrogen ions.

The pH scale is logarithmic, so for every one unit of change in pH there is a tenfold change in the hydrogen ion concentration. This means that a pH of 5 is 10 times more acidic than a pH of 6, while a pH of 4 is a 100 times more acidic than a pH of 6.

Learning Objectives:

Students will:

- Identify the relationship between hydrogen and hydroxide ions in acidic and basic solutions.
- Interpret color change of a pH indicator to determine whether a solution is an acid or a base.
- Determine the pH level of unknown substances using cabbage water indicator.
- Investigate what effects varying pH levels have on fish.



Procedure:

Day 1 — Introducing pH

Before class prepare cabbage water “purple liquid.” (See BM #1.)

Introduce this topic with a “magic” touch.

Change three clear liquids into three different colors by adding a purple liquid to each.

Materials:

3 clear cups 700 ml water

30 cc baking soda 50 ml vinegar

150 ml cabbage water indicator (purple liquid)

Magic Demonstration:

1. Put 250 ml of water into the first cup (neutral solution.) Mix a solution of 200 ml of water and 50 ml of vinegar into the second cup (acidic solution.) Put a solution of 250 ml of water and 30 cc of baking soda in the third cup (basic solution).
2. Place the three cups in front of the class in full view of the students. Inform class these are three different mystery liquids.
3. Ask students to predict what will happen when the purple liquid is added to the first cup. Then add 50 ml of the purple liquid to the first cup. (The solution will turn purple.)
4. Ask students to predict what will happen when the purple liquid is added to the second cup. Then add 50 ml of the purple liquid to the second cup. (The solution will turn green.)
5. Ask students to predict what will happen when the purple liquid is added to the third cup. Then add 50 ml of the purple liquid to the third cup. (The solution will turn pinkish-red.)
6. Ask students to offer explanations and list them on the board. Tell students they will be learning what caused these reactions and will be able to perform a little magic themselves.

Terms:

Students can use the Web site Chem4Kids.com “Acids and Bases” to find definitions for the following words:

aqueous	acid	base
strong acid	weak acid	strong base
weak base	neutral	



Day 2 — Learning about a pH scale

1. Introduce the pH scale. Show students an example of a pH scale. The pH scale ranges from 0 to 14, with a pH of 7 being neutral (pure water). If the pH is lower than 7, it is an acid. If the pH number is higher, it is basic. Aquatic organisms usually are found in waters having a pH ranging between 5 and 9. (See BM #2 for a pH scale diagram.)
2. Explain to students the structure of water molecules. The formula for a water molecule is H_2O . “H” is hydrogen; “2” shows that there are two hydrogen atoms; and “O” is oxygen. Water can also be thought of as molecules, each composed of one hydrogen ion (H^+) and one hydroxide ion (OH^-). Having an equal number of hydrogen and hydroxide ions, water is neutral. The concentration of hydrogen ions in a solution is very important for living things. If the level of hydrogen ions (H^+) increases, the substance is considered an acid and the pH is below 7. If the level of hydroxide ions (OH^-) increases, the substance is considered to be alkaline or basic and the pH is above 7.
3. Since the pH scale is logarithmic, for every unit of change on the scale, there is a tenfold change in the concentration of hydrogen ions (H^+). This means that a pH of 6 is 10 times more acidic than a pH of 7, and a pH of 5 is 100 times more acidic than a pH of 7.
4. Ask students to demonstrate this using the hydrogen ion and hydroxide ion cards. Hand out one complete set of hydrogen and hydroxide ion cards for each group of students (BM #3). This can be done in groups or as a demonstration. Have students pair the two cards with the single hydrogen ion and single hydroxide ion. Ask if the solution would be an acid, base, or neutral. (This solution would be neutral.)
5. Continue pairing a hydrogen ion card with a hydroxide ion card, keeping the same number of ions on each card (i.e., 10 H^+ with 10 OH^-) until students understand what makes a neutral solution and that it will always be 7 on the pH scale.
6. Ask students to pair the single ion cards. Ask what will make the solution have a pH of 6. (Add 10 H^+ .) Ask if the solution is now an acid, base or neutral (acid).
7. Ask students to pair the single ion cards again. Ask what will make the solution have a pH of 8. (Add 10 OH^- .) Ask if the solution is now an acid, base or neutral (base). Continue to create different levels on the pH scale by adding or taking away hydrogen ions and hydroxide ions.

Assessment:

The pH Scale – Students complete the missing information on the pH scale (BM #4) to show their understanding of the mathematical concepts of the logarithmic relationships of the pH scale.



Day 2 — Testing the pH of substances

Activity

Students will use a pH indicator to determine the pH level of unknown substances. (Purple = neutral; pink to red = acidic; green = basic.)

****Safety goggles should be worn during this activity.****

1. **Prepare ahead of time** cabbage water indicator (BM #1). Put five substances into separate cups labeled 1-5. These should be:

- 1 – lemon juice or vinegar
- 2 – distilled water
- 3 – ammonia
- 4 – soft drink
- 5 – baking soda and distilled water solution

2. Place students into groups of three or four. Each group will need the following items:

- 5 clear cups labeled 1-5
- 125 ml of cabbage water indicator (25 ml for each of the five cups)
- Graduated cylinder
- 6 disposable pipettes (one for each of the unknown substances; one for the indicator)
- 5 spoons (one for each unknown substances)
- 5 unknown substances (No. 1-5 from above)
- Data table (BM #5)

3. Students should measure and add 25 ml of cabbage water indicator in each of the five cups.

4. Students add 30 drops (approximately 2 ml) of the first unknown substance to the cup labeled 1. Stir with the spoon. Emphasize that the students are to use only one pipette and one spoon with each substance to avoid contamination.

5. Students continue with the same procedure with each unknown substance.

6. Students record color changes on the data table.

7. Students determine if each substance has an acid, base or neutral pH. Challenge students to arrange the cups in order from the most acidic to the most basic.

8. Estimate the pH of each substance and record on the data table. Students should explain how they arrived at their arrangement.

9. Students answer the questions on Part 2 of the data table.

10. Reveal the identity and pH level of each substance. Discuss students' answers to the questions on Part 2 of the data table sheet (BM #5).



Extension:

Students bring in “secret” substances for the class to identify pH.
Research pH of known substance and create a pH color scale.

Investigation:

Assess students’ prior knowledge of the effects pH levels can have on fish by developing a KWL chart.

K = What do you know?

W = What do you want to know?

L = What did you learn?

Students share what they know about fish and pH levels. List the information on the KWL chart. Ask students what they want to know and list the information on the chart.

Students will use resources, including the Internet, to locate information on preferred levels of pH for healthy fish. Students should also investigate what effects varying pH levels have on fish and the possible underlying causes for pH fluctuations.

At the end of the investigation, ask students what they learned. Add the new information to the KWL chart.

Assessment:

- Use the questions from Part 2 on the data table to evaluate students’ knowledge of how pH indicators show whether a substance is acidic, basic or neutral.

Extensions:

Note: Make sure students know that pH is just one part of the criteria of necessary conditions to maintain healthy fish in an aquarium.

- Students assess the quality of water samples from several different sources. Compare how the diversity of plants and organisms vary in each of the samples based on the pH levels.
Note: Most aquatic plants and animals have a specific pH range in which they can survive. The largest diversity of plants and animals will be found in the pH of 5 to 9. Most aquatic life cannot survive in an environment with a pH below 5 because it is too acidic, or above 9 because it is too basic.
- Set up an aquatic ecosystem. Students monitor the water conditions and keep a daily journal.
- Use pH test kits to test the pH of different household items or different foods.
- Invite a scientist from a local industry to discuss pH testing done in his/her job.

Lesson activities adapted from *Healthy Water, Healthy People: Water Quality Educators Guide* activity, *From H to OH!*



TEACHER REFERENCES:

Publications

Healthy Water, Healthy People: Testing Kit Manual. 2002. The Watercourse: Bozeman, Mont.
Available at <http://www.healthywater.org>.
Watercourse workshop distributes materials through training workshops and institutes as well as directly to the public.

Healthy Water, Healthy People: Water Quality Educators Guide. 2003. The Watercourse: Bozeman, Montana.
Available at <http://www.healthywater.org>.
A 250-page activity guide for educators of students in grades 6 through university.

Internet Sources

Fish Doc. *Fish Health and pH- Acidity and Alkalinity Explained*.
<http://www.fishdoc.co.uk/water/pH.htm>. Accessed June 14, 2004.
Information on how pH levels can affect fish health and suggestions on how to change pH levels.

Decelles, Paul. *pH Scale*. The Entangled Bank.
<http://staff.jccc.net/pdecell/chemistry/phscale.html>. Accessed June 27, 2005.
Full-color scale with examples of solutions at each pH level.

Rader's Chem4Kids. *Acids and Bases Are Everywhere*.
http://www.chem4kids.com/files/react_acidbase.html. Accessed June 14, 2004.
Site is designed for students. Explains pH scale and includes basic chemistry definitions.

Science Junction. *Water What-ifs: Water Quality and pH*.
<http://www.ncsu.edu/sciencejunction/depot/experiments/water/lessons/pH/>.
Accessed July 14, 2004.
Background information about pH.



Blackline Master #1

Cabbage Water Indicator

Materials

- Head of purple cabbage
- Food processor or knife and cutting board
- Saucepan, not aluminum
- 2 liters of distilled water, more for larger classes

Chop the cabbage into small pieces. Place cabbage in the saucepan and add distilled water. Bring to a boil and simmer for 20-30 minutes or until water turns a deep purple color. Strain the cabbage mixture and discard the cabbage. Refrigerate the purple liquid.

Note: It is best to make the cabbage water indicator on the same day you will use it, as it quickly becomes unstable as an indicator. Refrigerate the liquid until use.

Cabbage water and commercial indicators are the same product, therefore, a commercial indicator can be used as a substitute.



Blackline Master #2

Concentration of Hydrogen Ions (compared to pure water)	pH Scale	Concentration of Hydroxide Ions (compared to pure water)
Acidic 10,000,000	pH 0 battery acid	.0000001 Acidic
1,000,000	pH 1 stomach acid	.000001
100,000	pH 2 lemon juice	.00001
10,000	pH 3 orange juice	.0001
1,000	pH 4 acid rain	.001
100	pH 5 black coffee	.01
10	pH 6 milk	.1
Neutral 1	pH 7 pure water	1 Neutral
.1	pH 8 sea water	10
.01	pH 9 baking soda	100
.001	pH 10 milk of magnesia	1,000
.0001	pH 11 ammonia	10,000
.00001	pH 12 soapy water	100,000
.000001	pH 13 bleach	1,000,000
Basic .0000001	pH 14 liquid drain cleaner	10,000,000 Basic



1 Hydrogen Ion (H⁺)

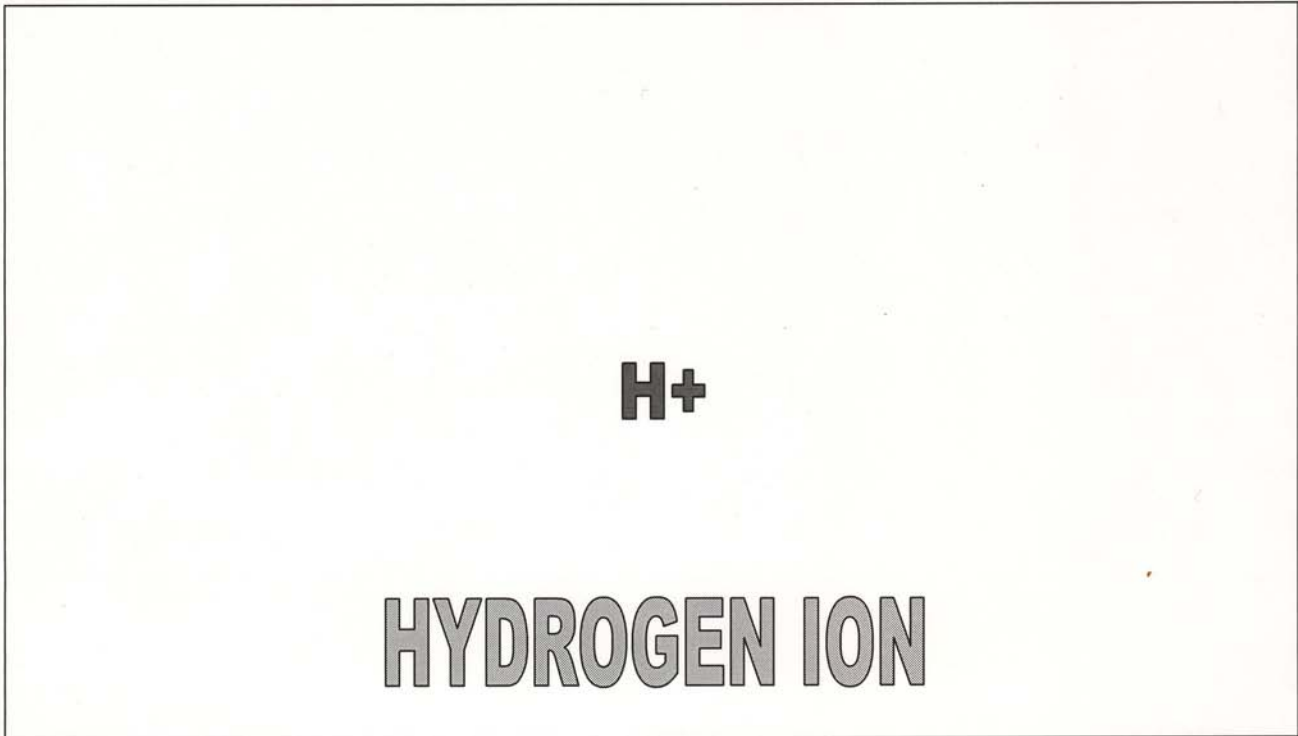

10 Hydrogen Ions (H⁺)

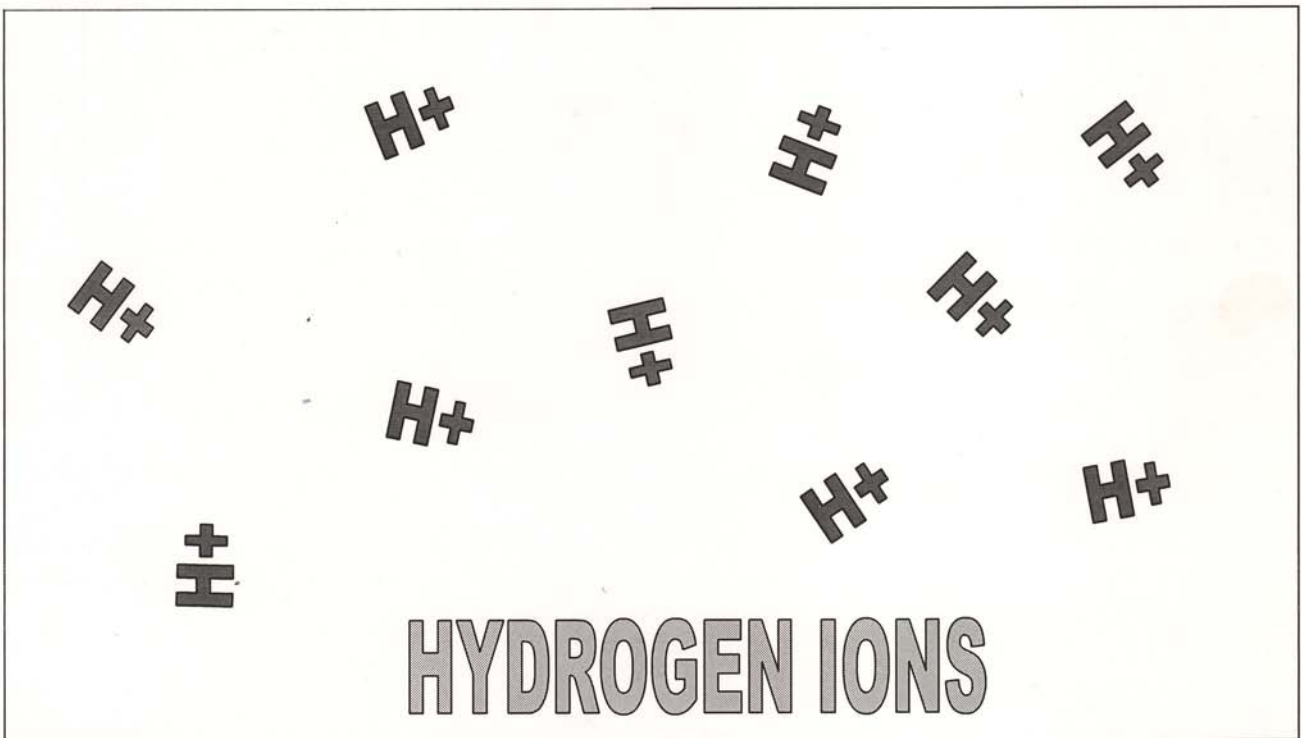



Blackline Master #3 (page 2)

100 Hydrogen Ions (H⁺)

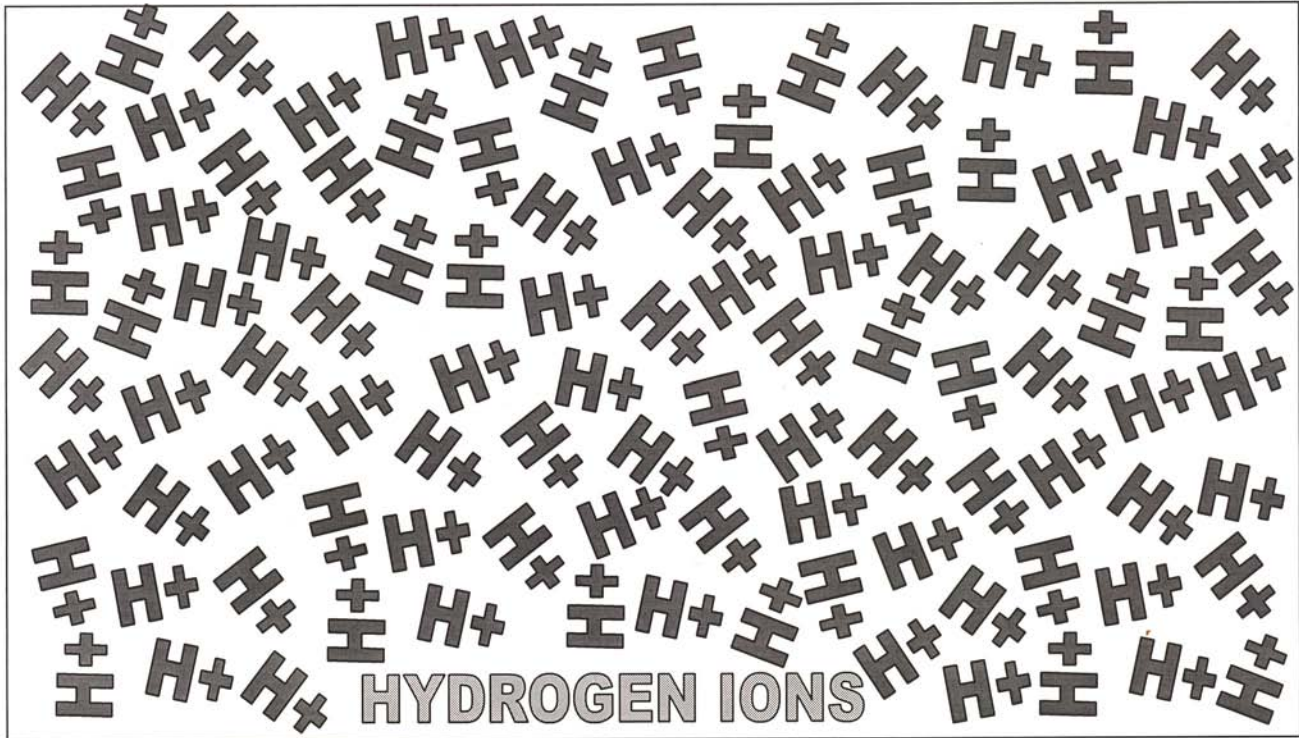

1 Hydroxide Ion (OH⁻)

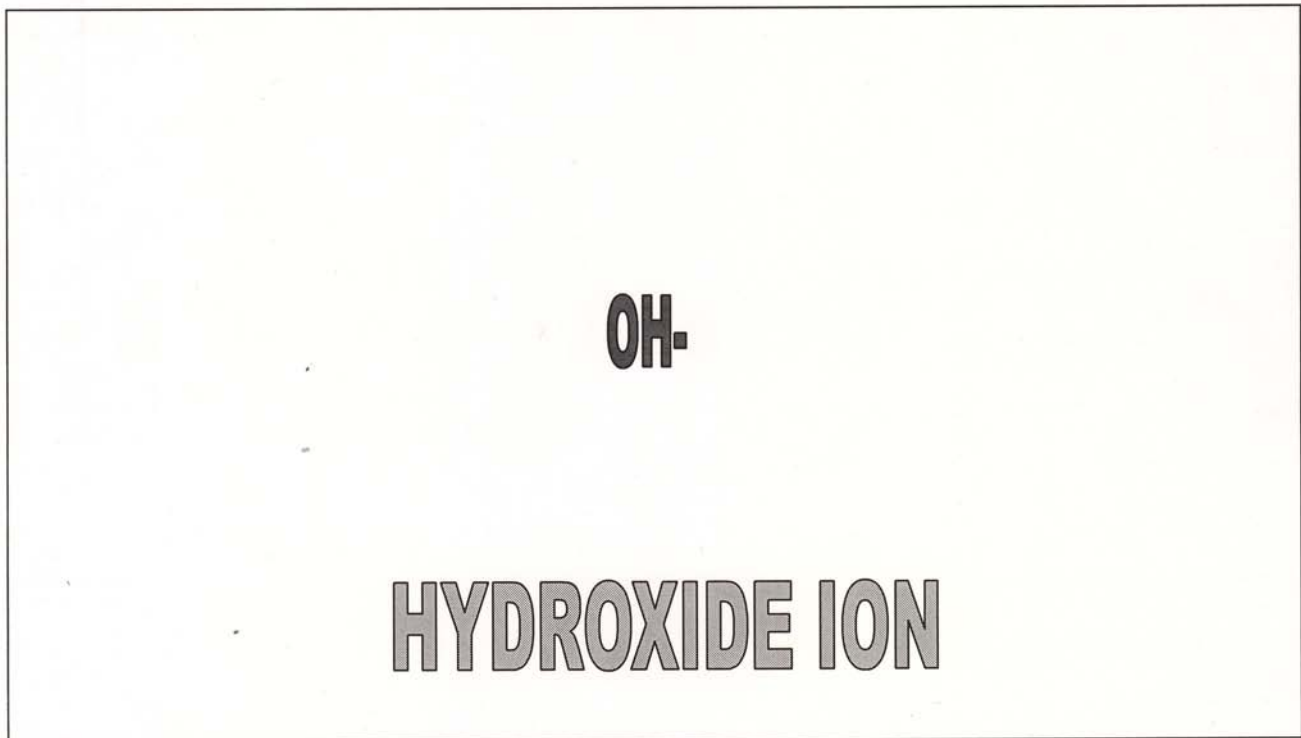



Blackline Master #3 (page 3)

100 Hydroxide Ions (OH⁻)



10 Hydroxide Ions (OH⁻)

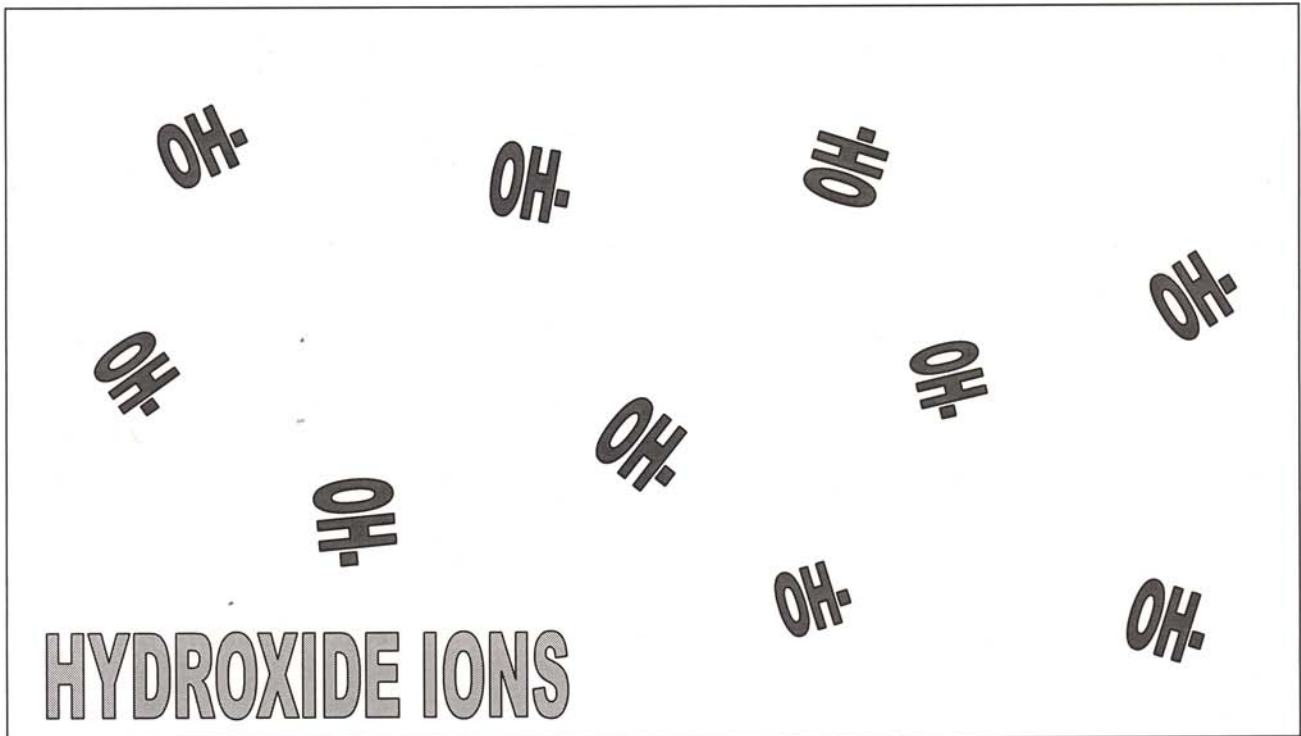



Blackline Master #4

Name _____

Concentration of Hydrogen Ions (compared to pure water)	pH Scale	Concentration of Hydroxide Ions (compared to pure water)
Acidic	pH 0 battery acid	Acidic
	pH 1 stomach acid	
	pH 2 lemon juice	
	pH 3 orange juice	
	pH 4 acid rain	
	pH 5 black coffee	
	pH 6 milk	
Neutral	pH 7 pure water	Neutral
	pH 8 sea water	
	pH 9 baking soda	
	pH 10 milk of magnesia	
	pH 11 ammonia	
	pH 12 soapy water	
	pH 13 bleach	
Basic	pH 14 liquid drain cleaner	Basic



Name _____

Data Table

Part 1

Record your findings on the table below.

Cup	Color of solution	Acid, base or neutral	Estimated pH	Actual pH	Name of substance
1					
2					
3					
4					
5					

Part 2

After completing the experiment, answer the following questions.

1. Which unknown substance is the strongest acid? How do you know?
2. Which unknown substance is the strongest base? How do you know?
3. Why is one solution more acidic than another?
4. What would happen to an acid solution if a base were added?
5. How accurate were the estimated pH levels compared to the actual pH levels?

Lyn Murphy
Tioga Junior High
Tioga, La.

Grade Level
Middle School (6-8)

Duration
Five 45-minute class periods
or additional week of
independent work

Subject Area
Inquiry

Materials List

- Computers with Internet access
- Teacher handout (BM #1)
- List of student questions (BM #2)
- Student Web sites (BM #3)
- Rubric (BM #4)

Grade/Standard/GLE
Science
6,7,8/SI-M-A-1/3

BM = Blackline Master

Snagging Paddlefish Information



Focus/Overview:

Students will conduct a Web search to research questions about basic paddlefish biology and ecology. After answering the questions, students will use the collected information to write and present a report that includes a title page with an image of a paddlefish and a bibliography.

Background Information:

See BM #1.

Learning Objective:

Student will:

- Use current literature to write a report about paddlefish biology and ecology.

Procedure:

1. Attention-grabber. Introduce the topic of paddlefish, discussing how the class will be raising paddlefish in the classroom. Ask the students, “Why should we raise paddlefish in our classroom?” Use the discussion generated to determine what, if any, prior knowledge the students have about paddlefish. Challenge students to use the Internet to investigate basic paddlefish biology and threats to paddlefish.
2. Project. Distribute handouts with the requirements for the report that they will write and questions to be researched (BM #2), the Web sites to be used (BM #3) and the rubric that will be used to assess the report (BM #4).
3. Teacher will read the reports then moderate a discussion of the findings to allow all students to benefit from the “unique finds” of students.

Note: This project can be done in groups or individually, depending on computer access.

Assessment:

See rubric (BM #4).

Resources:

See BM #5.



Blackline Master#1

Teacher Background Information on Paddlefish

Paddlefish (*Polyodon spathula*) are an ancient species of fish. Fossils of this odd-looking fish date back 400 million years. This means paddlefish lived before dinosaurs. They have a unique, paddle-shaped rostrum or nose and bodies that resemble a shark. Like the shark, a paddlefish's skeleton (including its forked, heterocercal tail) is made entirely of cartilage, except for the dentary or jawbone. A paddlefish has very few scales, similar to its close relative, the sturgeon. The paddlefish's few scales are located near the base of its tail fin.

There are only two species of paddlefish in the world, one in China and the other in the United States. Today, these river-dwelling fish are found in large, free-flowing rivers of the Mississippi River basin. They prefer the deep water and slow currents of pools, backwaters, impoundments and tail waters below dams. Historically, paddlefish were found beyond the Mississippi River basin and throughout the Great Lakes and Canada. The fish is now extirpated. In other words, the species is no longer found in Canada and some areas of the United States where it once lived.

Although extirpated and threatened in some areas, paddlefish from stable populations are harvested commercially and as a game fish in some states. The meat is considered flavorful. Even more desirable than the meat are its eggs or roe. Paddlefish roe, similar to caviar, is considered to be a delicacy. It is an expensive dish made up of unfertilized fish eggs from specific fish species. Since paddlefish mature slowly, taking the fish for only its roe has harmed some populations.

The most unique feature of the paddlefish is its rostrum, which is about one-third of its total body length. Scientists once believed that the rostrum was used to dig out food from stream bottoms. They now know that paddlefish are primarily filter feeders, and the rostrum has a sensory function. The rostrum is used to find food, and possibly to balance the fish's body in deep, swift-moving water. A paddlefish feeds by swimming with its large mouth open, using gillrakers to strain plankton from the water.

Although it is fast growing, a paddlefish matures slowly. Both males and females reach sexual maturity relatively late. Males mature at about 7 to 9 years, and females at 10 to 12 years. Though they like to live in deep water with slow currents, paddlefish leave these areas to spawn in cold, swiftly moving water when the water temperature reaches about 13°C (60°F.) Since timing for spawning is dependent upon temperature, spawning occurs at different times in different places, depending upon latitude. For example, spawning usually occurs in February in Louisiana and June in Montana — whenever the water temperature is right. Once fertilized, the eggs become sticky and settle to the bottom. Paddlefish prefer gravel bars for spawning so that their eggs will attach to the gravel surface. In Louisiana, there are few gravel bars, therefore, the fish spawn over hard surfaces. Paddlefish sometimes travel 100 to 200 miles to find an ideal habitat for spawning.



Blackline Master #1 (page 2)

The (0.08 - 0.12 in) eggs hatch about a week after the spawn. When first hatched, the young do not swim well, do not have a rostrum and have few defenses against predators. Perhaps the key to their survival is that the fish grow very quickly. Young paddlefish grow up to 2.5 cm (1 in) per week under ideal conditions.

Within a few weeks, fingerlings reach lengths of 10 to 13 cm (5 in) and develop a rostrum. Adult paddlefish can weigh up to 91 kg (200 lbs) reach lengths of up to 7 feet and live to be 30 years old, although the average lifespan is about 15 years.

For more than 100 years, many factors related to changes and destruction of habitat and overharvesting led to serious population declines of paddlefish. Human activities to improve flood control and navigation included dredging of rivers and the construction of levees, locks and dams. These actions helped industry and enabled people to live in flood-prone areas. However, these activities altered flow patterns and reduced the water flow (volume) of the Mississippi River and its tributaries, blocking movement of the fish and preventing them from reaching their spawning grounds. Pollution from industry and agriculture further degraded water quality and the remaining paddlefish habitat. Overharvesting for roe provided additional stress on the declining population.

Paddlefish have been extirpated in Canada, New York, Pennsylvania, Maryland and Virginia. In many other states, strict laws protect the population. In Minnesota, Nebraska, North Carolina, Ohio, Texas, West Virginia and Wisconsin, paddlefish populations are threatened, endangered or considered species of critical imperil, so laws were established to protect them. In Louisiana and Alabama, paddlefish are protected, and their population is stable. Several states, including Arkansas, Illinois, Indiana, Iowa, Kansas, Kentucky, Mississippi, Missouri, Montana, North Dakota, Oklahoma, South Dakota and Tennessee, have stable paddlefish populations that can continue to support commercial and/or game fishing.

Many programs have been developed in the United States to restore the paddlefish population throughout its natural range. State fish hatcheries, including Louisiana's, are playing a very important role to re-establish wild paddlefish populations. Tagging programs monitor populations and determine how well the fish are doing. Stocking programs aim to collect adult fish to artificially fertilize eggs, raise young paddlefish from eggs to fingerlings and return hundreds of thousands of fingerlings to natural habitat. Programs are also working to educate the public on the impaired status of this species. Teachers and students are learning about paddlefish, too. With our help, populations might be stabilized or re-established in states where they are threatened or extirpated.



Name _____

Snagging Paddlefish Information

Your job today is to find out some basic information about paddlefish that might help you understand why we want to raise them. You will begin by using the Web sites listed to answer the questions. Then, take the information you have collected and write a report about paddlefish. You will need to have a title page (with a picture of a paddlefish that is at least 4 x 4 inches), a body and a bibliography page with at least three Web sites correctly cited. You will be graded using the attached rubric.

Hint: Use its scientific name to get more results: *Polyodon spathula*.

1. Describe the paddlefish.
2. What fish are its closest relatives? What class is it in?
3. How and what do paddlefish eat?
4. How do paddlefish reproduce? How old must they be to reproduce?
5. In what states are paddlefish found? Describe the habitat of the paddlefish.
6. What kinds of problems threaten the paddlefish?
7. Are paddlefish threatened everywhere?
8. What problems does the paddlefish face in Louisiana?
9. How are paddlefish caught? Can they be caught legally in Louisiana?
10. What are we doing in Louisiana to help the paddlefish?
11. How do biologists raise paddlefish?

** Include in your report any other interesting facts that you discover in your reading.

Examples:

- Where do they live in Louisiana?
- How long can they live?
- How big do they grow?



Blackline Master #3 (page 1)

Student Resources:

American caviar – Paddlefish caviar. 1-800-caviar.com.

<http://www.1-800-caviar.com/paddle-fish.html>. Accessed July 22, 2003.

Commercial site that sells paddlefish roe, includes pricing and description of the taste of paddlefish roe.

Commonwealth of Pennsylvania, Fish and Boat Commission. *Question of the Week.*

http://sites.state.pa.us/PA_Exec/Fish_Boat/qpadl.htm. Accessed July 22, 2003.

Paddlefish restoration in Pennsylvania.

DeVries, Dennis. *Restoration of the Paddlefish in Alabama.* Auburn University Department of Fisheries and Allied Aquaculture and Alabama Department of Conservation and Natural Resources, Division of Wildlife and Freshwater Fisheries.

<http://www.ag.auburn.edu/fisheries/peak/paddlefish/>. Accessed July 22, 2003.

Describes Alabama paddlefish studies.

Division of Fisheries U.S. Fish and Wildlife Southwest Region. *Facts About Fish in the Southwest – paddlefish.*

<http://southwest.fws.gov/fishery/species/paddlefish.htm>. Accessed June 11, 2004.

Includes paddlefish biology, and describes legal catch of paddlefish in Iowa.

Hatch, Jay and Nicole Paulson. *All About Paddlefish.* Minnesota Pollution Control Agency.

<http://www.pca.state.mn.us/kids/fish/paddlefish.html>. Accessed July 22, 2003.

Designed for kids. Paddlefish biology and distribution in Minnesota.

Tennessee Aquarium and the IMAX 3-D Theater. *Amazing Animals-Fish: Paddlefish.*

<http://www.tnaqua.org/Animals/Fish.asp#>. Accessed June 15, 2004.

Pictures and reasons that paddlefish are threatened, and brief descriptions of paddlefish biology.

Helfrich, Lou. *The Virtual Aquarium.* Virginian Polytechnic Institute and State University.

<http://www.cnr.vt.edu/efish/families/polyodontidae.html>. Accessed July 20, 2003.

Excellent pictures and an outline of paddlefish biology and discussion of the threats to the paddlefish.

Iowa Department of Natural Resources. *Fishes of Iowa.*

<http://www.iowadnr.com/fish/iafish/pad-card.html>. Accessed June 15, 2004.

Includes paddlefish biology and describes legal catch of paddlefish in Iowa.

Koncilya, Linda. *Paddlefish!* Glendive Chamber of Commerce.

<http://www.midrivers.com/~chamber/pfish.htm>. Accessed July 22, 2003.

How to catch and cook Montana paddlefish, as well as information about the paddlefish.

Louisiana Department of Wildlife and Fisheries. *Fishing Regulations 2002.*

<http://www.wlf.state.la.us/apps/netgear/page1.asp>. Accessed July 22, 2003.

Status of paddlefish protection in Louisiana.



Blackline Master #3 (page 2)

Mims, Steve. *Paddlefish Polyculture*. Kentucky State University Aquaculture Program.
<http://www.ksuaquaculture.org/index.htm>. Accessed July 22, 2003.
Aquaculture of paddlefish with catfish. Includes a video on paddlefish feeding.

Montana River Action. *Paddlefish*. <http://www.montanariveraction.org/paddlefish.html>.
Accessed July 22, 2003.
Information on Montana fishing and roe, along with concerns for overfishing.

Paulson, Nicole and Jay Hatch. *Paddlefish*, *Polyodon spathula*. Minnesota Department of
Natural Resources and U.S. Fish and Wildlife Service.
<http://www.gen.umn.edu/research/fish/fishes/paddlefish.html>. Accessed July 22, 2003.
Discusses the fishes of Minnesota. The site was designed for educational purposes and
includes pictures, biology and reasons for paddlefish decline.

Springer, Craig. *Paddlefish Make a Comeback in Oklahoma*. Native Fish Conservancy.
<http://www.nativefish.org/Articles/spoonbill.htm>. Accessed July 22, 2003.
Paddlefish restoration efforts in Oklahoma.

Truman Info Guide. *Spoonbill* - (Paddlefish=*Polyodon spathula*).
<http://www.trumaninfo guide.com/GeneralDoc/paddleFish.cfm>. Accessed June 15, 2004.
Distribution of paddlefish in Missouri and fishing for paddlefish in Missouri.

Texas Parks and Wildlife. *Texas Freshwater Fishing: Paddlefish*.
www.tpwd.state.tx.us/fish/infish/species/pad/pad.htm. Accessed June 11, 2004.
Biology of paddlefish, life cycle, habitat and threats to paddlefish in Texas.

U.S. Fish & Wildlife Service. *Natchitoches National Fish Hatchery*.
<http://natchitoches.fws.gov/WHAT.HTML>. Accessed June 11, 2004.
Describes hatchery propagation of paddlefish and other fish. Photographs of hatching jars
and paddlefish information about visiting the hatchery.



TEACHER REFERENCES:

Publications

Reed, Bobby C., et al. 1992. "Growth, Fecundity, and Mortality of Paddlefish in Louisiana." *Transactions of the American Fisheries Society*. 121:378-384.

A comprehensive study of paddlefish in Louisiana.

Williamson, D.F. 2003. *Caviar and Conservation: Status, Management and Trade of North American Sturgeon and Paddlefish*. TRAFFIC North America: Washington D.C. Electronic edition of the report available at <http://www.traffic.org>.

Multimedia

Wills, Betty. *The Paddlefish: An American Treasure* (video). Earthwave Society:
Fort Worth, Texas.

This video addresses all facets of the life of paddlefish in the United States. It includes information on ongoing conservation efforts and methods, as well as the reasons for the decline of the population and current laws. Summary and ordering information at <http://www.earthwave.org/paddlefish.htm>. Cost \$24.95 plus shipping and handling.

Internet sources

Species at Risk. Canadian Wildlife Service-Environment Canada.
http://www.speciesatrisk.gc.ca/search/speciesDetails_e.cfm?SpeciesID=63.

Accessed July 23, 2003.

Paddlefish information site. Includes biology, habitat and photos.



Blackline Master #4

Name _____

Date _____

Rubric – Snagging Paddlefish Data Report

Read this rubric, and use it to see exactly how you will be graded.

Category	1	2	3	4
Grammar, spelling and formatting	Numerous errors > 5 errors	3 - 5 errors	1 error	No errors
Content questions answered correctly	More than 5 incorrect answers	3 - 5 incorrect	1 - 2 incorrect	All correctly answered
Analysis of answers	No analysis done	1 detailed conclusion	2 detailed conclusions	More than 2 conclusions
Information gathering and bibliography	Information from 1 site only	2 Web sites or incorrectly cited	3 Web sites most correctly cited	4 or more Web sites correctly cited
Your total points =				

Students may get bonus points for including information from printed materials.

Note: Turn in this sheet with your report!

- A = 15-16 points
- B = 14 points
- C = 12-13 points
- D = 11 points
- F = 10 or fewer points



Critical Conditions for Paddlefish Spawning

Tracy Armand
Grolee Elementary
Opelousas, La.

Grade Level
Middle School (6-8)

Duration
Two 45-minute class
periods

Subject Area
Inquiry
Life Science
Environmental Science

- Materials List**
- Colored paper 8.5 x 11” (five colors: 13 sheets of each)
 - Rope or masking tape
 - 4 hula hoops, yarn or masking tape
 - Fish cards (BM #1)
 - Season cards (BM #2)
 - Water level/movement cards (BM #3)
 - Water temperature cards (BM #4)
 - Gravel cards (BM #5)
 - Game layout (BM #6)
 - Student recording sheet (BM #7)
 - 5 plastic or paper bags

Grade/Benchmark/GLE Science
6,7,8/SI-M-A4/12,13
6,7,8/SI-M-A7/19,22
7/SE-M-A4/39
6,7,8/LS-M-C4
HS/LS-H-D3/26 (biology)
HS/LS-H-D4/27 (biology)
HS/LS-H-F3/35 (biology)

BM = Blackline Master

Focus/Overview:

Through an active simulation, students learn about several critical environmental factors necessary for paddlefish spawning. They will examine some risks and consequences to the environment created by human actions.

Background Information:

Despite their ability to grow fast, paddlefish become sexually mature late in life. Males become sexually mature between the ages of 7 and 9 years and females between the ages of 10 and 12. Males may spawn every year, but females require two or more years to produce eggs. The female produces approximately 4.5 to 5.4 kg (10 to 12 lbs) of eggs.

Environmental conditions must be just right in order for the female to spawn. Paddlefish spawn in the early spring (February or early March for Louisiana fish) when the water temperature is approximately 13°C (60°F.)

Besides the right temperature, fast-flowing, high, rising water and clean gravel bars are necessary. If gravel bars are not available (as in the case of Louisiana) a hard substrate makes a great substitute. During spawning, the female paddlefish is accompanied by several males. As she releases eggs, the pursuing males release sperm (milt), fertilizing the eggs.

As fertilization occurs, the eggs become sticky and adhere to rocks. The eggs are kept free from silt and debris and remain oxygenated by the fast-moving flow of the water. Eggs hatch in seven days or less at temperatures of 15°C to 18°C (60°F to 65°F).

Learning Objectives:

Students will:

- Identify critical environmental factors necessary for successful spawning.
- Describe human and natural inhibitors to paddlefish spawning.



Procedure:

Advance Preparation:

Hint: Laminate cards if possible and adjust the number of cards to reflect class size.

1. For a class of 30

Note: Use a different color paper for each card type

Make:

- 13 copies of “Fish Cards” (BM #1)
- 13 copies of “Season Cards” (BM #2)
- 13 copies of “Water Level/Movement Cards” (BM #3)
- 13 copies of “Water Temperature Cards” (BM #4)
- 13 copies of “Gravel Bars Cards” (BM #5)

Cut out cards.

2. Set up a playing field as shown (BM #6) on the school playground or gymnasium floor. Use a rope (outdoor location) or masking tape (indoor location) to indicate the boundaries of the field. Within the playing field, mark four areas with yarn, masking tape or hula hoops.
3. Place “Season Cards” in one marked area, “Water Level/Movement Cards” in another, “Water Temperature Cards” in another and “Gravel Bars Cards” in the last. In each marked area, place the cards face down in a random order. These are known as protected areas.
4. At the end of the playing field, in the “spawning grounds,” place three bags/boxes labeled: “Spawn,” “Death” and “No Spawn.”
5. At the start line, place a bag filled with “Fish Cards.” Players will take a card before starting a round.

Activity:

1. Object of the game:

Each player’s goal is to reach the spawning grounds with all four condition cards. In the spawning grounds, players will determine if their fish was able to spawn.

2. Death cards:

Some condition cards have a death circumstance. If a player picks a death card, he/she must go directly to the death bag/box at the end of the field, place one fish card and any condition cards collected in it, and sit out for the rest of the round.

3. Rules:

- No running.
- Players may only stay in the marked, protected card areas for 10 seconds.
- Collect only one card from each card area.

4. Teacher directions:

- Give each player two “Student Recording Sheets” (BM #7). Player will place and leave the “Student Recording Sheet” in the spawning grounds.



- Choose two students – one to be a predator and one to be a poacher. Provide each with a bag to collect cards. As the paddlefish students move between the card areas, these two students **may only walk** to tag them. Switch poacher and predator with each round.
*If your class has fewer than 20 students, assign only one poacher or predator.

5. Playing the Game:

- Players start out at the end of the playing field opposite the spawning grounds.
- Players will use one “Fish Card” per round. Each card represents a live paddlefish. Players take a card out of the fish card bag before starting the round.
- During each round, players will move to each card area, collecting one card at each area. Once all players have taken four cards, they will go to the end boundary, the spawning grounds.
- Players should watch out for the poacher and predator. If a player is tagged by a poacher or predator outside a protected card area, the player must give them a fish card and sit out the rest of the round. The poacher or predator will take the prey to the death bag; then he/she will return to the playing field.
- Players are safe as long as they are in a card area or beyond the lines that mark the boundaries at each end of the playing field. Time limit for fish to stay in a safe area is 10 seconds.
- At the end of each round players will look at their cards and record their results on the “Student Recording Sheet” (BM #7). Then students will determine which bag (“Spawn,” “No Spawn” or “Death”) in which to place their cards.
 - If a “Death Card” is drawn, the player must stop playing the round and go directly to the bag at the end boundary. There they will place the “Death Card” and one “Fish Card” in the “Death” bag along with the other situation cards collected. On the recording sheet, the player would indicate a death situation was drawn.
 - If all critical conditions are met for spawning (season, gravel bars, water temperature and water level/movement cards), each of these cards and a “Fish Card” will be placed in the “Spawn” bag.
 - If all critical conditions are not met, players must place their cards and a “Fish Card” in the “No Spawn” bag.
- Discuss with students their experience at this point. Ask “How many fish were able to spawn? How many died?” Have students describe some of the cards they drew. Ask “What were some of the conditions that prevented paddlefish from spawning?”
- Play the game twice more. Move the outer boundaries in by 2 or 3 feet at some point in the field to represent a river narrowed by a dam or other means. Give students time to complete their recording sheets.



- Replay the game again. This time, split the group of players in half to represent a smaller population of fish. Each of the smaller groups will play two rounds for a total of four rounds. Record the results (BM #7). Compare the results of the two sizes of groups of paddlefish after playing three rounds with different numbers of “Fish Cards.” Ask students to list and discuss the advantages and disadvantages of population size.
- Back in the classroom or the next day, review with students some of the situations they encountered throughout the simulation. Have them again describe some of the cards they drew from each area. What were some of the critical factors necessary to make it to the spawning grounds? Record students’ observations, leading them, as needed, to infer specifics of each critical environmental factor.

Assessment:

- Students will draw or describe an ideal paddlefish habitat. Be sure they explain why they included each item or condition. How did these features provide for the needs of the paddlefish? What are ways that competition could alter the ideal habitat?
- Students will draw a concept map of critical conditions for spawning.

Extension:

As a class, combine all student data sheets to determine the spawning success of the population. Graph the results. What portion of the population was able to spawn? Failed? Died?

TEACHER REFERENCES:

Publications

Reed, Bobby C., W.E. Kelso and D.A. Rutherford. 1992. Louisiana Department of Wildlife and Fisheries. *Growth, Fecundity, and Mortality of Paddlefish in Louisiana*. Transactions of the American Fisheries Society.

A comprehensive study of paddlefish in Louisiana.

Internet sources

Corsentino, Pattyanne. 1995. *Ecosystem Matters: Activity and Resource Guide for Environmental Educators*. U.S. Department of Agriculture.

<http://www.na.fs.fed.us/spfo/pubs/misc/eco/>. Accessed June 14, 2004.

Iowa Department of Natural Resources. *Paddlefish*.

<http://www.iowadnr.com/education/files/pddlfsh.pdf>. Accessed Jan. 21, 2004.

















Texas Parks and Wildlife. *Texas Freshwater Fishing: Paddlefish*.

<http://www.tpwd.state.tx.us/fish/infish/species/pad/pad.htm>. Accessed Jan. 21, 2004.

Biology of paddlefish life cycle, habitat and threats to paddlefish in Texas.



Fish Cards



Season Cards

<p>Spring is for spawning! Season</p>	<p>Spring is for spawning! Season</p>
<p>Spring is for spawning! Season</p>	<p>Spring is for spawning! Season</p>
<p>Spring is for spawning! Season</p>	<p>Spring is for spawning! Season</p>
<p>Spring is for spawning! Season</p>	<p>Spring is for spawning! Season</p>
<p>Spring is for spawning! Season</p>	<p>Spring is for spawning! Season</p>
<p>Spring is for spawning! Season</p>	<p>Spring is for spawning! Season</p>
<p>Spring is for spawning! Season</p>	<p>Spring is for spawning! Season</p>
<p>Summer is too late. Season</p>	<p>Summer is too late. Season</p>
<p>Winter isn't the right time. Season</p>	<p>Winter isn't the right time. Season</p>
<p>Fall doesn't have the right conditions. Season</p>	<p>Fall doesn't have the right conditions. Season</p>



Water Level/Movement

<p>Spring flooding brings fast-moving water.</p> <p>Water level/movement</p>	<p>Whoa ... this water's deep! Perfect for spawning.</p> <p>Water level/movement</p>
<p>The water level is too low to support spawning.</p> <p>Water level/movement</p>	<p>Whoa ... this water's deep! Perfect for spawning.</p> <p>Water level/movement</p>
<p>Beavers in your area erect a super dam that has slowed the flow of water and lowered the level upstream. Too bad – no spawning.</p> <p>Water level/movement</p>	<p>The weatherman forecasts days and days of rain – enough for spawning.</p> <p>Water level/movement</p>
<p>There are no obstructions to slow the flow of the rising water.</p> <p>Water level/movement</p>	<p>The weatherman forecasts days and days of rain – enough for spawning.</p> <p>Water level/movement</p>
<p>A dam is built along the river. Your pathway is cut off and you cannot travel upriver for spawning.</p> <p>Water level/movement</p>	<p>Spring flooding brings fast-moving water.</p> <p>Water level/movement</p>
<p>Drought strikes. The water level drops to record lows. You can't spawn this year.</p> <p>Water level/movement</p>	<p>The water level is too low to support spawning.</p> <p>Water level/movement</p>
<p>Spring flooding brings fast-moving water.</p> <p>Water level/movement</p>	<p>There are no obstructions to slow the flow of the rising water.</p> <p>Water level/movement</p>
<p>The weatherman forecasts days and days of rain – enough for spawning.</p> <p>Water level/movement</p>	<p>Spring flooding brings fast-moving water.</p> <p>Water level/movement</p>
<p>The water level is too low to support spawning.</p> <p>Water level/movement</p>	<p>Whoa...this water's deep! Perfect for spawning.</p> <p>Water level/movement</p>



Water Temperature

<p>Warm water means phytoplankton blooms and lower dissolved oxygen levels. Dead paddlefish don't spawn. GO TO DEATH BAG. </p>	<p>It's been too cold to find much food. Not enough energy to spawn.</p> <p>Water temperature</p>
<p>The water is 14°C (58°F) – great for spawning!</p> <p>Water temperature</p>	<p>It's too warm to spawn. Not today.</p> <p>Water temperature</p>
<p>The water is 16°C (61°F) – great for spawning!</p> <p>Water temperature</p>	<p>The water is 16°C (61°F) – great for spawning!</p> <p>Water temperature</p>
<p>The water is near 16°C (60°F) – great for spawning!</p> <p>Water temperature</p>	<p>The water is 14°C (58°F) –_great for spawning!</p> <p>Water temperature</p>
<p>The water is 15°C (59°F) – great for spawning!</p> <p>Water temperature</p>	<p>The water is 16°C (61°F) – great for spawning!</p> <p>Water temperature</p>
<p>The water is 16°C (60°F) – great for spawning!</p> <p>Water temperature</p>	<p>The water is 15°C (59°F) –_great for spawning!</p> <p>Water temperature</p>
<p>It's been too cold to find much food. Not enough energy to spawn.</p> <p>Water temperature</p>	<p>The water is near 16°C (60°F) – great for spawning!</p> <p>Water temperature</p>
<p>Brrr ... -5°C (23°F) - too cold.</p> <p>Water temperature</p>	<p>The water is 15°C (59°F) –_great for spawning!</p> <p>Water temperature</p>
<p>It's too warm to spawn. Not today.</p> <p>Water temperature</p>	<p>The water is near 16°C (60°F) – great for spawning!</p> <p>Water temperature</p>



Gravel Bars

<p>Spring flooding brings fast-moving water and clean gravel bars.</p> <p>Gravel Bars</p>	<p>Spring flooding brings fast-moving water and clean gravel bars.</p> <p>Gravel Bars</p>
<p>The river bottom has been dredged. There is no gravel to be found, and spawning will not be successful.</p> <p>Gravel bars</p>	<p>Stagnant water means dirty gravel bars. Not good for spawning.</p> <p>Gravel bars</p>
<p>Concerned citizens clean away obstructions in the river. Gravel bars are clean.</p> <p>Gravel bars</p>	<p>Spring flooding brings fast-moving water and clean gravel bars.</p> <p>Gravel Bars</p>
<p>Stagnant water means dirty gravel bars. Not good for spawning.</p> <p>Gravel bars</p>	<p>Spring flooding brings fast-moving water and clean gravel bars.</p> <p>Gravel Bars</p>
<p>The river bottom has been dredged. There is no gravel to be found, and spawning will not be successful.</p> <p>Gravel bars</p>	<p>Stagnant water means dirty gravel bars. Not good for spawning.</p> <p>Gravel bars</p>
<p>Spring flooding brings fast-moving water and clean gravel bars.</p> <p>Gravel bars</p>	<p>Concerned citizens clean away obstructions in the river. Gravel bars are clean.</p> <p>Gravel bars</p>
<p>Concerned citizens clean away obstructions in the river. Gravel beds are clean.</p> <p>Gravel bars</p>	<p>Concerned citizens clean away obstructions in the river. Gravel bars are clean.</p> <p>Gravel bars</p>
<p>Spring flooding brings fast-moving water and clean gravel beds.</p> <p>Gravel bars</p>	<p>Spring flooding brings fast-moving water and clean gravel bars.</p> <p>Gravel Bars</p>
<p>Concerned citizens clean away obstructions in the river. Gravel bars are clean.</p> <p>Gravel bars</p>	<p>Stagnant water means dirty gravel bars. Not good for spawning.</p> <p>Gravel bars</p>



LAYOUT FOR PLAYING GAME

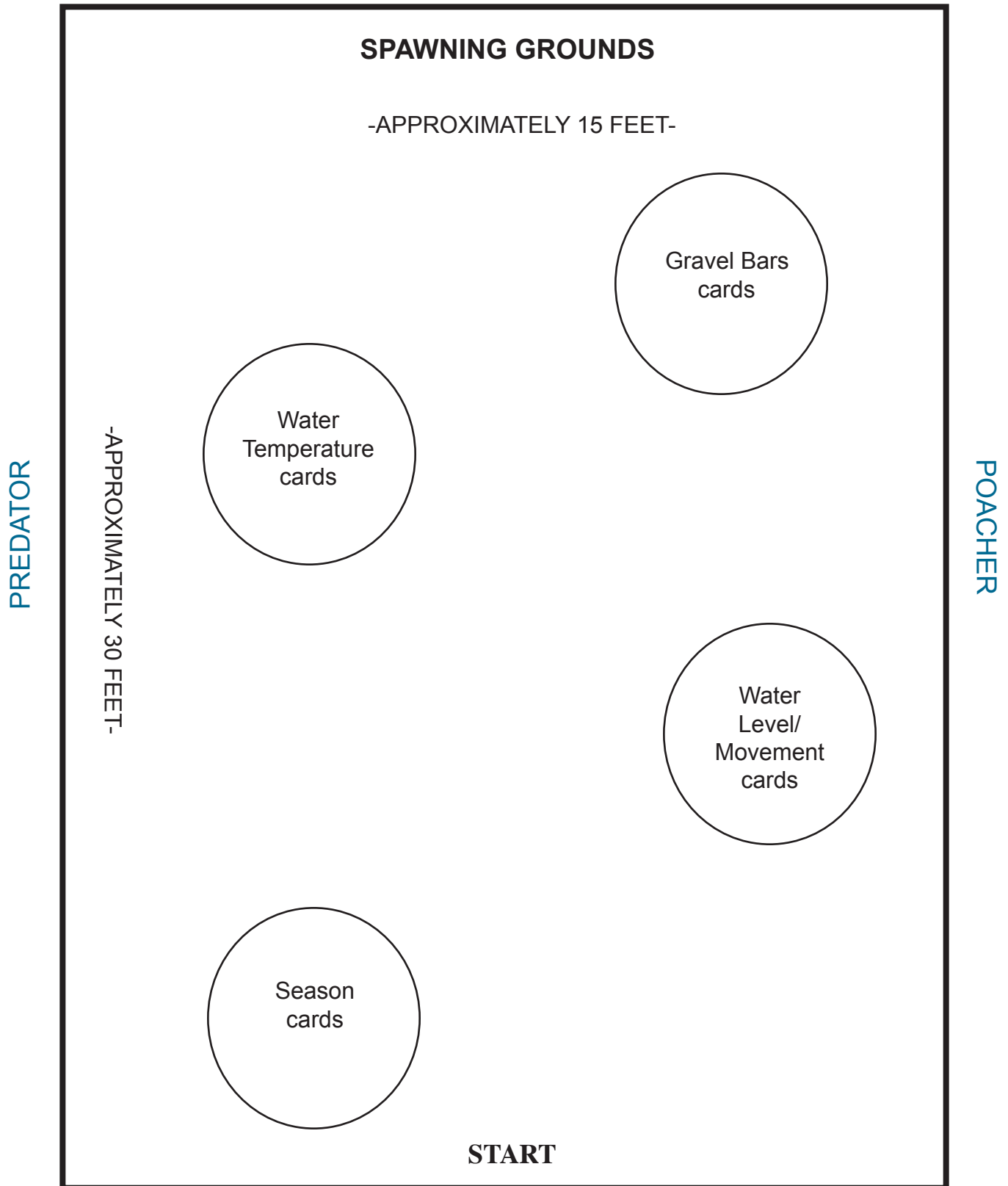



Name _____

Student Recording Sheet

Round 1

Situation cards	Describe Condition	Enables Spawning
Season		Y N
Water Level/Movement		Y N
Water Temperature		Y N
Gravel Bars		Y N

Round 2

Situation cards	Describe Condition	Enables Spawning
Season		Y N
Water Level/Movement		Y N
Water Temperature		Y N
Gravel Bars		Y N

Round 3

Situation cards	Describe Condition	Enables Spawning
Season		Y N
Water Level/Movement		Y N
Water Temperature		Y N
Gravel Bars		Y N

Round 4

Situation cards	Describe Condition	Enables Spawning
Season		Y N
Water Level/Movement		Y N
Water Temperature		Y N
Gravel Bars		Y N



Blackline Master #7 (page 2)

Round 5

Situation cards	Describe Condition	Enables Spawning
Season		Y N
Water Level/Movement		Y N
Water Temperature		Y N
Gravel Bars		Y N

Round 6

Situation cards	Describe Condition	Enables Spawning
Season		Y N
Water Level/Movement		Y N
Water Temperature		Y N
Gravel Bars		Y N

What situations prevented paddlefish from spawning? _____

What critical conditions allowed spawning to occur?

How many of your fish were you able to spawn? _____ of total _____ = _____ percent

How many died? _____ of total _____ = _____ percent

How many were unable to spawn? _____ of total _____ = _____ percent

Sabrina Ardoin
Krotz Springs Elementary
Krotz Springs, La.

Grade Level
Middle School (6-8)

Duration
45 minute class period

Subject Area
Inquiry
Life Science

Materials

For each group:

- Tree cookie transparency (BM #1)
- Tree cookie image (BM #2)
- Paddlefish jawbone picture (BM #3 and 4)
- Fish otolith image (BM #5)
- 1 hand lens per group
- Pencils and color pencils
- Rulers

For each student:

- Vocabulary handouts
- Student journals

Grade/Benchmark/GLE Science

6-8/SI-M-A3/7
6-8/SI-M-A5/16
6-8/SI-M-B3/31

BM = Blackline Master

How Old Is That Fish?



1 of 12

Focus/Overview:

Students will examine actual cross sections or pictures of cross sections of a tree cookie, an otolith and a paddlefish dentary (jawbone). They will note similarities and differences. Students will then use their observations to make inferences about the relationships among them.

Background Information:

The age of a tree can be determined by counting the growth rings. Each spring's new growth is seen as an area of light-color wood surrounded by a darker area, which is the result of the tree's fall transition. Ring size tends to vary, depending on the environmental conditions the tree is exposed to.

Poor environmental conditions, such as drought and infestations, result in narrow or damaged rings, while thicker, smooth rings indicate better environmental conditions.

Scientists have determined that the same type of relationship exists in the otoliths (ear bones) of some fish species. Paddlefish, a cartilaginous species, can be aged in the same manner using their dentary (jaw) bones. Like tree cookies, otoliths and dentaries are cross-sectioned and then examined under a microscope to determine the age of the fish and the varying environmental conditions that have affected growth. Each ring correlates to one year for all of these species.

Learning Objectives:

Students will:

- Observe and interpret seasonal growth changes in plants and animals by analyzing and describing their growth rings.
- Ask appropriate questions about organisms and events in the environment.
- Base explanations and logical inferences on scientific knowledge, observations and evidence.
- Recognize that there is an acceptable range of variation in collected data.



Procedures:

Focus:

Instruct students to examine and discuss rings on tree cookies. Explain that trees put on new growth in the spring, which is indicated by the presence of the light-colored wood. Point out the dark wood produced in the fall when the tree is preparing for winter. Ask, "How do scientists determine how old a tree is?" Give students the opportunity to explain how the rings are counted.

Explain that both the dark and light wood together make up one growth ring, indicating one year in the tree's life cycle. Ask them if all rings are the same and ask why this is so or not. (Tell students that to answer the question they will make an inference, a conclusion based on facts).

Explain that the tree's environment during growth can change, which results in rings that reflect those changes, good or bad. It is possible in some years to make more than one ring. These false rings are due to disease, injury or frost damage. Therefore, students should recognize an acceptable range or variation in the data collected from some of their samples. Have students make inferences about the environmental factors that may have affected the tree's growth.

Presentation:

Demonstration

Using the overhead projector and a tree cookie transparency (BM #1), show the correct method to count the rings. * **Use a ruler to divide the cookie into pizza-like wedges.** Students select a wedge that is clear and easily counted.

Counting Rings on Tree Cookies

1. Locate the darker colored heartwood (inactive wood tissue) in the center of the tree cookie. The outer edge of the heartwood is the starting point for counting the rings.
2. Count the number of rings of sapwood (active wood tissue) extending to the region of inner bark. Remember, the light-colored rings are springwood and the dark-colored rings are summerwood, together encompassing one year's growth.

Show that it doesn't matter if you choose to count dark or light rings as long as you choose one and count consistently. Do not count the bark as a growth ring. Its growth is not complete.

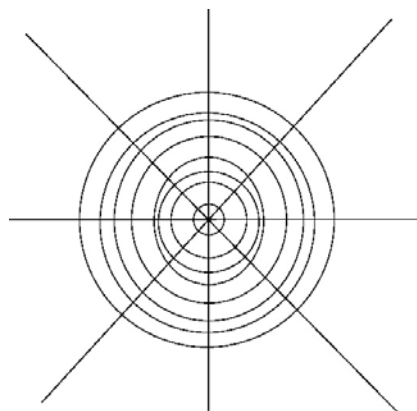



3. Explain that other types of living things can be aged in a similar way, like black drum and paddlefish. Explain that some fish species like the black drum have inner ear bones called **otoliths**, which are large enough to be cross-sectioned and counted to determine the fish's age. In black drum each ring represents a year.

A paddlefish though, is a fish that does not have hard bones; it is a cartilaginous fish. The only solid bone-like structure is the **dentary** or jawbone. This bone can be dried and cross-sectioned and then the annual rings can be counted to age the fish. Aging the paddlefish dentaries should be done in the same manner as the tree cookie.

Note: Paddlefish that live in the South have a “halo” effect on the rings of the dentary bone cross section from uneven summer feeding. In northern regions the paddlefish have distinct rings. A dentary cross section of a paddlefish from a northern state could be used for comparison.

Activity:

1. Divide students into groups of three or four.
2. Give each group a picture of an otolith, dentary or a tree cookie. (BMs #2, 3, 4 and 5)
3. Students will record, in their journals, their own prediction of which organism they are aging and approximately how old it is.
4. Students will work together to draw “pizza” lines and then count the growth rings on their sample. Have each student individually count rings.
5. Students will record their outcomes, compare them to their predictions and make inferences about the characteristics of the environment based on growth ring sizes. Emphasize as findings are shared, that there is an acceptable range of variation in collected data.
 - Age of tree in BM #1 is 20 years; an acceptable range is 19 to 21 years.
 - Age of tree in BM #2 is 11 years; an acceptable range is 9 to 12 years.
 - Age of paddlefish on BMs #3 and #4 is 7 years; an acceptable range is 6 to 8 years.
 - Age of black drum in BM #5 is 23 years; an acceptable range is 22 to 24 years.
6. Students will compare results with one another. Provide sufficient time for discussion and recounting.
7. Groups will present their findings to the class orally.

Review

1. Name three organisms whose age can be determined by counting growth rings.
[Counting growth ring can age trees, black drum and paddlefish.](#)
2. What is an otolith?
[An otolith is an ear bone from a fish.](#)
3. How do growth rings act as an indication of the environmental factors that have affected the organism's growth?
[Wide rings indicate good growing conditions, adequate nutrition, the right temperature, and other proper conditions for growth. Thin rings indicate poor conditions and delayed or retarded growth.](#)
4. What is an inference?
[An inference is a conclusion based on facts.](#)



Assessment Method:

- Use a rubric to score student journals. (BM #6).
- Add a discussion question to a regular weekly test.
For example: What inferences can be made from examining growth rings?
What makes up a growth ring?
Explain “aging an organism.”

Extension:

- Students research environmental factors that might affect the growth ring development in each of the three species.

TEACHER REFERENCES:

Publications

Eymard, Tami and Brian T. Hardcastle. *A Practical Handbook on Otolith Removal for LDWF Age and Growth Studies*. Lyle S. St. Amant Marine Laboratory: Grand Terre Island, LA. Pp 1-9.

Project Learning Tree, Environmental Education Activity Guide “*Tree Cookies*”. 2000.
American Forest Foundation, Washington, D.C. pp 402. www.plt.org. Accessed July 22, 2003.
Pages 289-292.
Reproducible information on dendrochronology, complete with lessons.

Internet sources

Grissino-Mayer, Henri D. *Ultimate Tree Ring Web Pages*. Department of Geography, University of Texas. <http://web.utk.edu/~grissino/>. Accessed July 22, 2003.
Web site with multiple links and many levels of information, pictures, and even printable lessons on annular tree rings.

Louisiana Department of Wildlife and Fisheries. www.wlf.state.la.us
Accessed July 22, 2003.
Source of many things including otolith and dentary pictures.

“Paddlefish” Page 3, Life History and Ecology. Montana Department of Fish, Wildlife and Parks, Miles City, Montana.

Scarnecchia, Denis L. and Brad Schmitz. *Paddlefish*. Montana Department of Fish, Wildlife and Parks, Miles City, Montana. www.fisheries.org/AFSmontana/SSCpages/Paddlefish.htm.
Accessed July 22, 2003.

School of the Coast and Environment, Louisiana State University. *Coastal Fisheries Institute Age and Growth Laboratory*. <http://www.cfi.lsu.edu/lifehistory/>. Accessed July 23, 2003.
Web site contains images of otoliths. Author has given permission to use the pictures.



Blackline Master #1

Tree Cookie #1



Photo courtesy Dr. HD Grissino-Mayer, University of Tennessee, used by permission granted Oct. 17, 2003



Blackline Master #2

Tree Cookie #2

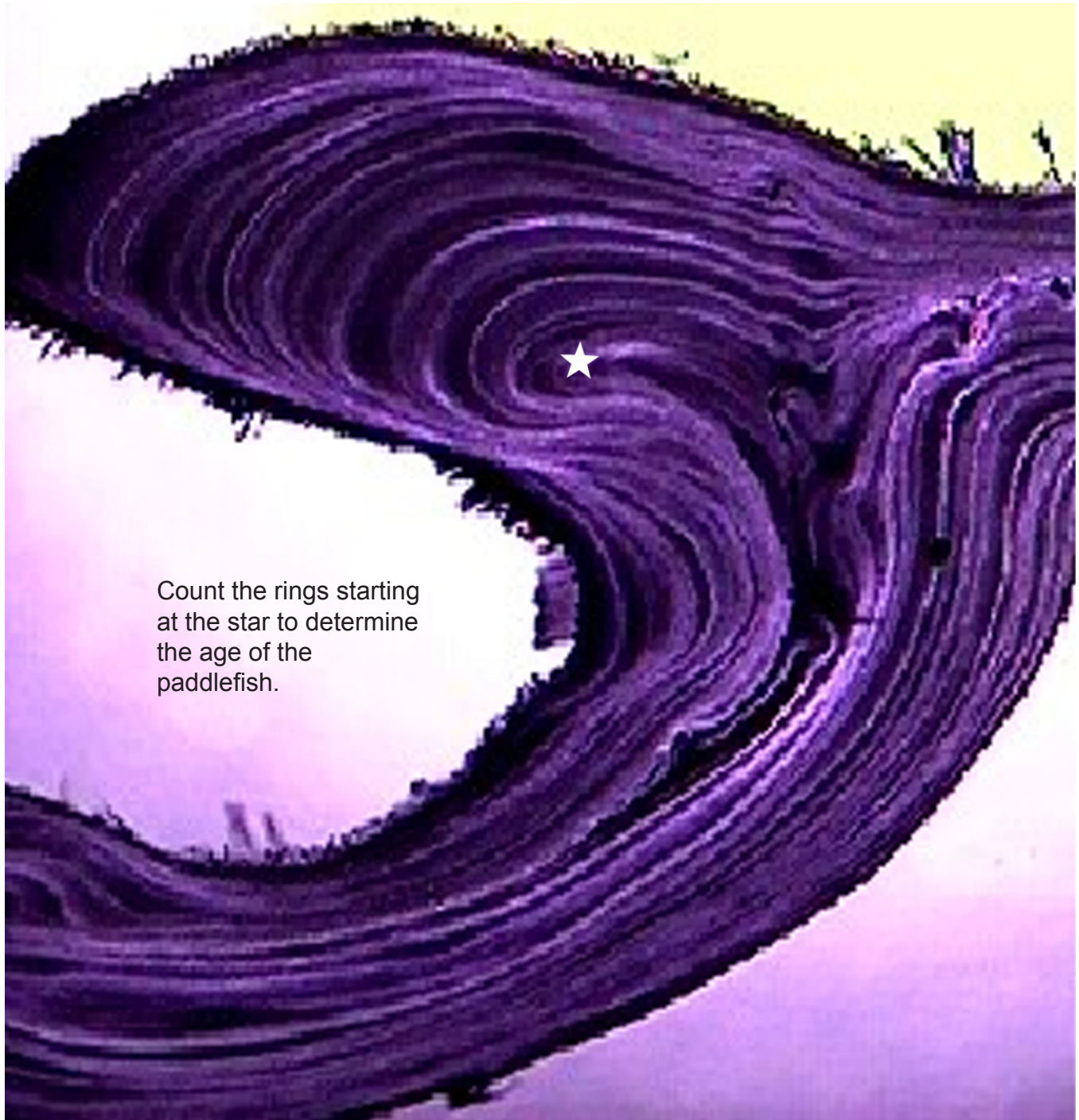

Photo courtesy Dr. HD Grissino-Mayer, University of Tennessee, used by permission granted Oct. 17, 2003



Blackline Master #3

Paddlefish Dentary #1



Count the rings starting
at the star to determine
the age of the
paddlefish.

Photo courtesy Bobby Reed, Louisiana Department of Wildlife and Fisheries



Blackline Master #4

Paddlefish Dentary #2

Count the rings starting at the star to determine the age of the paddlefish.

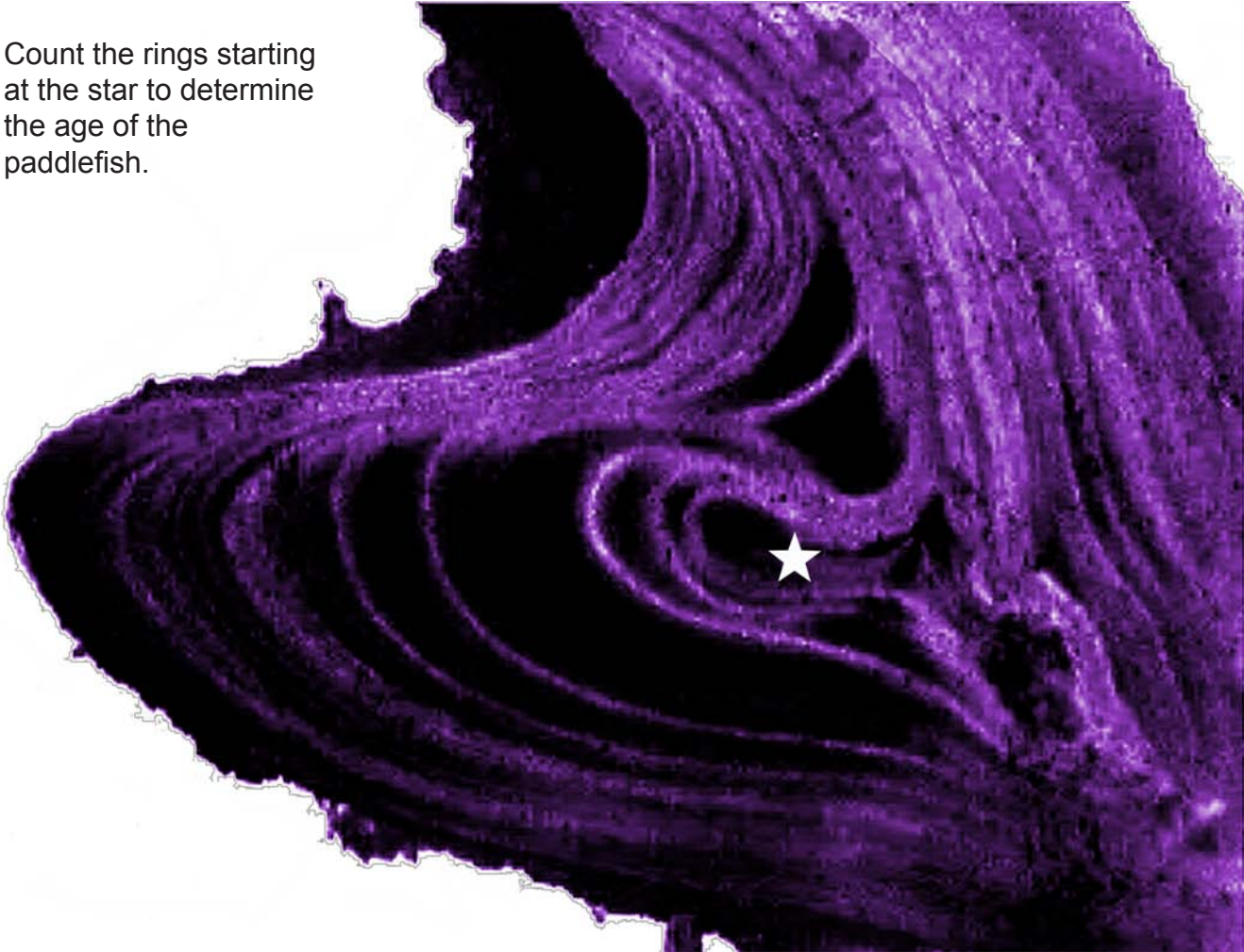
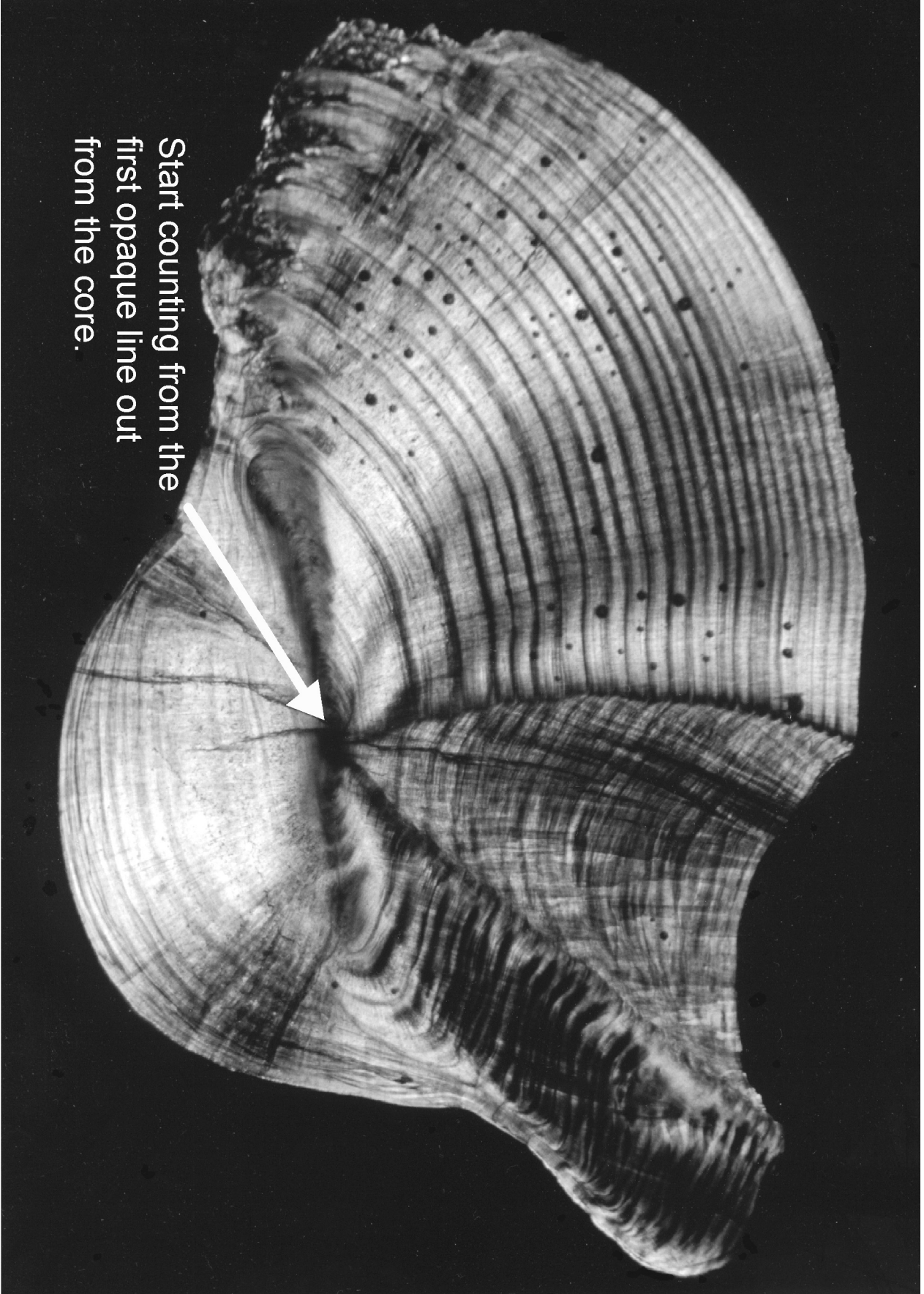

Photo courtesy Jeff Quin, Arkansas Game and Fish Commission



Blackline Master #5

Black Drum Otolith



Start counting from the first opaque line out from the core.

Photo courtesy Coastal Fisheries Institute, Louisiana State University



Blackline Master #6

Journal Rubric – How Old IS That Fish?

Entry Topic: Student journals should reflect their own prediction of the age, species and environmental conditions that affected their species' growth. They should be able to explain the correlation between the annual rings of the three organisms.

- _____ 0 pts. No effort – Nothing written.
- _____ 1pt. Student predicts and correctly ages the species.
- _____ 2 pts. Student predicts, correctly ages and determines the type of organism. Student hints at reasons for differences in ring thickness.
- _____ 3pts. Student predicts, correctly ages and determines the type of organism. Student gives good possible reasons for the differing thicknesses of the rings, and tells which years were better growth years.
- _____ 4pts. Student predicts, correctly ages and determines the type of organism. Students gives good environmental reasons for differences in ring sizes, and makes clear inferences about the similarities among otoliths, dentaries and tree rings.

Point Assignment _____ Date _____ Student name _____

Entry Topic: Student journals should reflect their own prediction of the age, species and environmental conditions that affected their species' growth. They should be able to explain the correlation between the annual rings of the three organisms.

- _____ 0 pts. No effort – Nothing written.
- _____ 1pt. Student predicts and correctly ages the species.
- _____ 2 pts. Student predicts, correctly ages and determines the type of organism. Student hints at reasons for differences in ring thickness.
- _____ 3pts. Student predicts, correctly ages and determines the type of organism. Student gives good possible reasons for the differing thicknesses of the rings, and tells which years were better growth years.
- _____ 4pts. Student predicts, correctly ages and determines the type of organism. Students gives good environmental reasons for differences in ring sizes, and makes clear inferences about the similarities among otoliths, dentaries and tree rings.

Point Assignment _____ Date _____ Student name _____



Blackline Master #7

Answer Key

Paddlefish Dentary #1

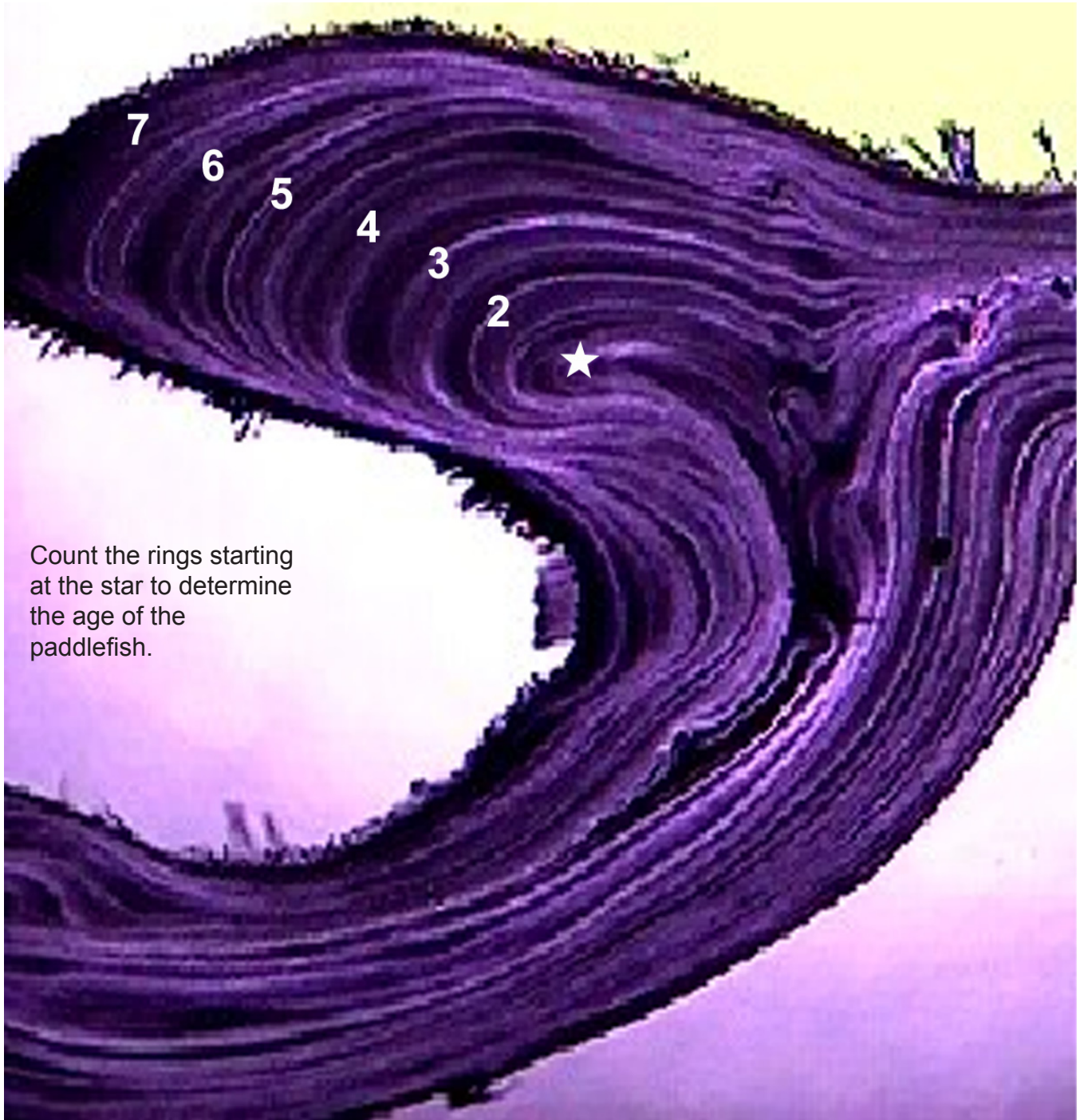

Count the rings starting at the star to determine the age of the paddlefish.

Photo courtesy Bobby Reed, Louisiana Department of Wildlife and Fisheries



Blackline Master #8

Answer Key

Paddlefish Dentary #2

Count the rings starting at the star to determine the age of the paddlefish.

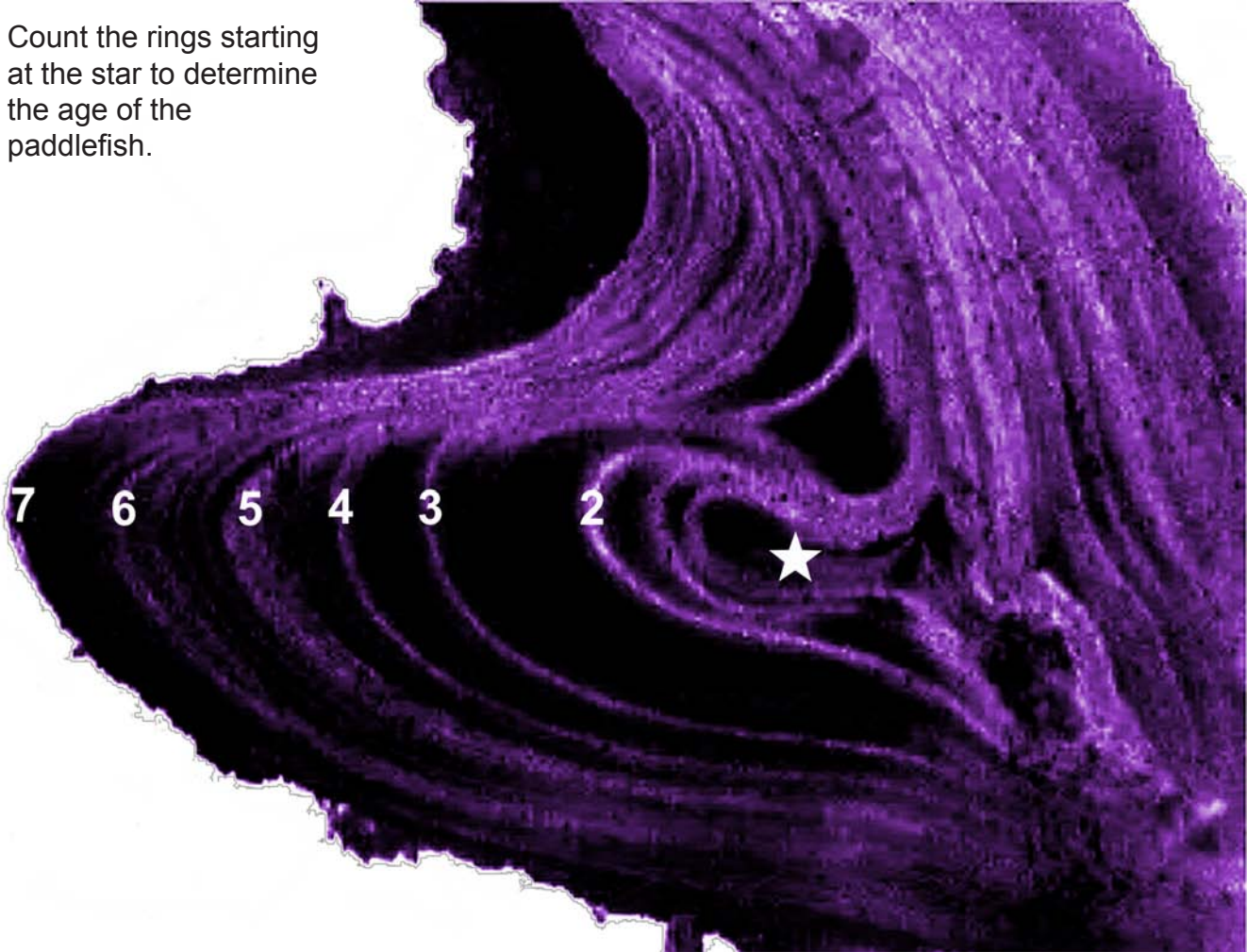

Photo courtesy Jeff Quin, Arkansas Game and Fish Commission



Extirpated? Don't You Mean Extinct?

Focus/Overview:

Students will create vocabulary flash cards and collect data from classroom discussions, handouts regarding paddlefish status in the United States, their habitat needs and the wildlife management practices being used to save them and to expand the population. Students will become familiar with terms common to the understanding of the species' status and examine possible causes of species loss.

Background Information:

The North American paddlefish is a large species of fish that has historically inhabited the rivers and streams of the Mississippi River drainage basin and some lower areas of Canada. Once a plentiful species, it has been overharvested by fishermen for its highly prized roe (unfertilized eggs). Fishermen have not been the only obstacles for these fish. They have been cut off from traditional breeding areas by dams, control structures and levees. Industrial pollution has destroyed their habitat in some areas, causing complete loss of the population in some states. Today, many states have programs in place to help the population recover and laws that govern the harvesting of eggs and the fishing of the species. Despite these measures, the paddlefish may never recover completely.

Learning Objectives:

Students will:

- Define the terms endangered, extirpated, protected, threatened and extinct as they relate to an animal or plant species.
- Identify the historical and present range of the American paddlefish (*Polyodon spathula*).
- Identify possible environmental causes for the decline in paddlefish population numbers in the United States.

Sabrina Ardoin
Krotz Springs Elementary
Krotz Springs, La.

Grade Level
Middle School (6-8)

Duration
One to two 45-minute
class periods

Subject Area
Inquiry
Reading
Environmental Science

Materials List

- United States maps
- Colors/color pencils
- Note cards or construction paper
- Handouts (BM #1-3)
- Assessment (BM #4-6)
- Picture of paddlefish

Grade/ Benchmark/GLE Science

6-8/SI-M-A1/3
6-8/SI-M-A4/11
SE-M-A3
7/SE-M-A4/39
SE-M-A5

Language Arts

6/ELA-1-M1/1,3
7,8/ELA-1-M1/1
6/ELA-1-M3/6
7,8/ELA-1-M3/4
9-12/ELA-1-H3/4

BM = Blackline Master



Procedure:

Introduce the topic

Draw students to a discussion by asking questions. Ask, "What does the term extinct mean? Can you name an extinct animal? Why is this animal extinct? Where did this animal live? What did this animal eat?" These questions will facilitate a lengthy discussion. Explain to students that, yes, some species are extinct, and some other species are declining in numbers, but are not completely missing from our world yet. Explain that we all need to understand what extinct means, but we also need to know some other very important terms used to describe the present status of species populations.

Create vocabulary flashcards

Pass out note cards or colored construction paper squares. Students print one term on the front of each card, then flip the card over and print the term's meaning on the opposite side (See BM #1). Repeat the process for each term. These will be study tools for the students. Discuss each term as the card is created.

Introduce paddlefish and its status

Show students a picture of a paddlefish and explain that the status of this fish varies from state to state. It is a fish commonly found in the Mississippi River drainage basin, but not in the numbers of the past. It has been extirpated from some states, is endangered in some states, protected in many states and is generally a fish of concern. Pass out background information (BM #2). Ask students to read them silently.

Map paddlefish status

Pass out maps of the United States (BM #3). Using the background information, students shade the states in red that list the paddlefish as extirpated, blue for stable populations with fishing, yellow for endangered/threatened/critically imperiled, green for states that have paddlefish populations that are protected, and no color for states that are not a documented natural habitat of the paddlefish. (See answer sheet, BM #4.)

Using the completed maps, return to a discussion that focuses on possible reasons for the different status these states assign the paddlefish. Have students flip their maps and list some possible reasons for the decline of the paddlefish population. Discuss measures some states, including Louisiana, are taking to help restore the population.



Important Points in Lesson:

1. What is the status of the paddlefish in Louisiana?
The paddlefish is a protected species in Louisiana and may not be legally fished for any reason.
 2. What does the term extirpated mean?
Extirpated means that a species has disappeared from a specific area, but still exists in other areas.
 3. What does extinct mean?
Extinct means that a species no longer exists anywhere in the world and has no chance of ever returning; it is lost forever.
 4. What are some reasons for the changes in the paddlefish status?
 - Loss of or alteration of spawning areas
 - Construction of dams, control structures or other obstruction of natural waterways
 - Reduction of water levels and or reduced flow rate in streams
 - Pollution
 - Overharvesting and egg collection for roe
- **Analyze the impact of these changes on the paddlefish population.

Assessment:

- Vocabulary test (BM #5)
- Essay or journal entry in which students clearly distinguish between extirpated and extinct in relation to the paddlefish, identify reasons for extirpation, and describe restoration measures (BM #6).

Extensions:

- Build a Web search guiding students to sites that provide answers to paddlefish status, state by state.
- Enlarge the focus of the lesson to include all countries of the world and all paddlefish species, so that students will realize the limits of their existence.
- Have students research local waterways to find out if paddlefish are indigenous to their area.



TEACHER REFERENCES:

Publications

Aquatic Education Program. (Teacher's Manual). Booker Fowler Hatchery, Forest Hill, Louisiana 71430.

Booker-Fowler Fish Hatchery Aquatic Education Program, "Wildlife Laws and What They Mean." U.S. Fish and Wildlife Services Office of Endangered Species: Washington, D.C. Available from Angela Capello, Louisiana Department of Wildlife and Fisheries.

Booker-Fowler Fish Hatchery Aquatic Education Program, "Learn the Terms". Western Regional Environmental Education Council, (Project WILD), U.S. Fish and Wildlife Service Office of Endangered Species: Washington, D.C. Available from Angela Capello, Louisiana Department of Wildlife and Fisheries.

Capello, Angela. *Booker Fowler Fish Hatchery and the Story of Finnie the Fingerling*. Louisiana Department of Wildlife and Fisheries Aquatic Education Program: Baton Rouge. A coloring/storybook depicting the hatchery's role in the development of specific species of fish, including the paddlefish.

Williamson, D.F. 2003. *Caviar and Conservation: Status, Management and Trade of North American Sturgeon and Paddlefish*. TRAFFIC North America: Washington D.C. Electronic edition available at <http://www.traffic.org>.

Multimedia

Wills, Betty. *The Paddlefish: An American Treasure* (video). Earthwave Society: Fort Worth, Texas. This video addresses all facets of the life of paddlefish in the United States. It includes information on ongoing conservation efforts and methods, as well as the reasons for the decline of the population and current laws. Summary and ordering information at <http://www.earthwave.org/paddlefish.htm>. Cost \$24.95 plus shipping and handling.

Internet sources

Quarry Commando.com. *Paddlefish Facts*. <http://www.quarrycommando.com/paddlefish.html>. Accessed July 22, 2003. Overview of all aspects of paddlefish: range, adaptations and life cycle. Includes many pictures.

Species at Risk. *Paddlefish*. <http://www.speciesatrisk.gc.ca>. Accessed July 22, 2003. Lists all known species that are designated at risk or endangered in North America and Canada. Specific threats to habitat are listed.

Upper Midwest Environmental Sciences Center. *Paddlefish Study Project*. <http://www.umesc.usgs.gov/aquatic/fish/paddlefish/main.html>. Accessed June 14, 2004. Excellent source of information. Contains an animated map of the distribution of paddlefish.



Vocabulary List

SPECIES	A group of organisms that can interbreed and produce more of their own kind.
HABITAT	A place where an animal or plant lives and obtains food, water, shelter and living space.
POPULATION	Two or more individuals of the same kind, occupying a specific area.
EXTINCT	No longer existing or living anywhere on the earth.
ENDANGERED	In great danger or at risk of ceasing to exist.
PROTECTED	Limited in number, and protected by state laws from being disturbed.
THREATENED	An animal or plant that is likely to become endangered in the future throughout a significant part of its range.
EXTIRPATED	A species that no longer exists in one geographic area, but still survives in others.
OCCURRENCE	To exist or be present.
RANGE	A geographical area in which a species of organisms lives.
LIMITING FACTOR	Anything that interferes with or prevents a species from living.
STATUS	Current state of a species' existence.
RESTORATION	To return to a former state of healthy existence.
CONSERVATION	Actions to improve or sustain the health of a species in order for it not to be listed as endangered or threatened.
NATIVE SPECIES	A species that occurs naturally in an area.
POACH	To kill, collect or hunt an animal or a plant illegally.
RESTRICTED	Laws and regulations to govern or limit the use or harm of something.
SPECIES OF CONCERN	Informal term indicating that USFWS has some concern for the future well-being of the species but does not grant it Endangered Species Act protection.
CRITICALLY IMPERILED	Informal term for a very small or rapidly declining population that is at a risk for extinction.



Student – Paddlefish Background

Paddlefish (*Polyodon spathula*) are an ancient species of fish. Fossils of this odd-looking fish date back 400 million years. This means paddlefish lived before dinosaurs. They have a unique, paddle-shaped rostrum or nose and bodies that resemble a shark. Like the shark, a paddlefish's skeleton (including its forked, heterocercal tail) is made entirely of cartilage, except for the dentary or jawbone. A paddlefish has very few scales, similar to its close relative, the sturgeon. The paddlefish's few scales are located near the base of its tail fin.

There are only two species of paddlefish in the world, one in China and the other in the United States. Today, these river-dwelling fish are found in large, free-flowing rivers of the Mississippi River basin. They prefer the deep water and slow currents of pools, backwaters and impoundments, and tail waters below dams. Historically, paddlefish were found beyond the Mississippi River basin and throughout the Great Lakes and Canada. The fish is now extirpated. In other words, the species is no longer found in Canada and some areas of the United States where it once lived.

Although extirpated and threatened in some areas, paddlefish from stable populations are harvested commercially and as a game fish in some states. The meat is considered flavorful. Even more desirable than the meat are its eggs or roe. Paddlefish roe, similar to caviar, is considered to be a delicacy. It is an expensive dish made of unfertilized fish eggs from specific fish species. Since paddlefish mature slowly, taking the fish for only its roe has harmed some populations.

The most unique feature of the paddlefish is its rostrum, which is about one-third of its total body length. Scientists once believed that the rostrum was used to dig out food from stream bottoms. They now know that paddlefish are primarily filter feeders, and the rostrum has a sensory function. The rostrum is used to find food, and possibly to balance the fish's body in deep, swift-moving water. A paddlefish feeds by swimming with its large mouth open, using gillrakers to strain plankton from the water.

Although it is fast growing, a paddlefish matures slowly. Both males and females reach sexual maturity relatively late. Males mature at about 7 to 9 years, and females at 10 to 12 years. Though they like to live in deep water with slow currents, paddlefish leave these areas to spawn in cold, swiftly moving water when the water temperature reaches about 13°C (60°F). Since timing for spawning is dependent upon temperature, spawning occurs at different times in different places, depending upon latitude. For example, spawning usually occurs in February in Louisiana and June in Montana — whenever the water temperature is right. Once fertilized, the eggs become sticky and settle to the bottom.

Paddlefish prefer gravel bars for spawning so that their eggs will attach to the gravel surface. In Louisiana, there are few gravel bars, therefore, the fish spawn over hard surfaces. Paddlefish sometimes travel 100 to 200 miles to find an ideal habitat for spawning.



Blackline Master #2 (page 2)

The 2 to 3 mm (0.08 to 0.12 in) eggs hatch about a week after the spawn. When first hatched, the young do not swim well, do not have a rostrum and have few defenses against predators. Perhaps the key to their survival is that the fish grow very quickly. Young paddlefish grow up to 2.5 cm (1 in) per week under ideal conditions. Within a few weeks, fingerlings reach lengths of 10 to 13 cm (5 in) and develop a rostrum. Adult paddlefish can weigh up to 291 kg (200 lbs) reach lengths of up to 7 feet and live to be 30 years old, although the average lifespan is about 15 years.

For more than 100 years, many factors related to changes and destruction of habitat and overharvesting led to serious population declines of paddlefish. Human activities to improve flood control and navigation included dredging of rivers and the construction of levees, locks and dams. These actions helped industry and enabled people to live in flood-prone areas. However, these activities altered flow patterns and reduced the water flow (volume) of the Mississippi River and its tributaries, blocking movement of the fish and preventing them from reaching their spawning grounds. Pollution from industry and agriculture further degraded water quality and the remaining paddlefish habitat. Overharvesting for roe provided additional stress on the declining population.

Paddlefish have been extirpated in Canada, New York, Pennsylvania, Maryland and Virginia. In many other states, strict laws protect the population. In Minnesota, Nebraska, North Carolina, Ohio, Texas, West Virginia and Wisconsin, paddlefish populations are threatened, endangered or considered species of critical imperil, so laws were established to protect them. In Louisiana and Alabama, paddlefish are protected, and their population is stable. Several states, including Arkansas, Illinois, Indiana, Iowa, Kansas, Kentucky, Mississippi, Missouri, Montana, North Dakota, Oklahoma, South Dakota and Tennessee, have stable paddlefish populations that can continue to support commercial and/or game fishing industries.

Many programs have been developed in the United States to restore the paddlefish population throughout its natural range. State fish hatcheries, including Louisiana's, are playing a very important role to re-establish wild paddlefish populations. Tagging programs monitor populations and determine how well the fish are doing. Stocking programs aim to collect adult fish to artificially fertilize eggs, raise young paddlefish from eggs to fingerlings, and return hundreds of thousands of fingerlings to natural habitat. Programs are also working to educate the public on the impaired status of this species. Teachers and students are learning about paddlefish, too. With our help, populations might be stabilized or re-established in states where they are threatened or extirpated.



Blackline Master #3 Name _____

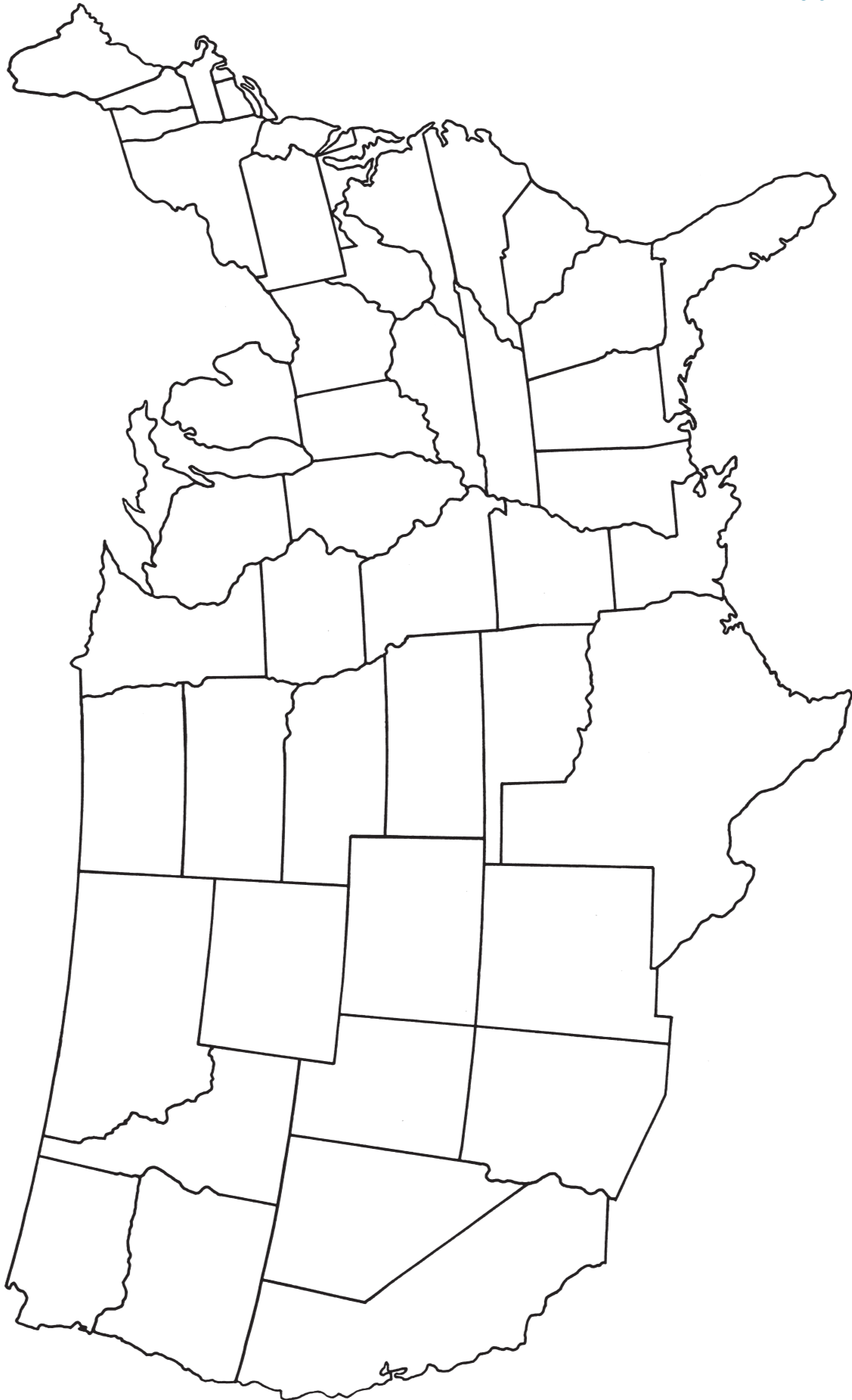



Name _____

Vocabulary Test

Match terms with the correct definition.

____ 1. Species	A. Actions to improve the health of a species in order for it not to be listed as endangered or threatened.
____ 2. Habitat	B. Laws and regulations to govern or limit the use or harm of something.
____ 3. Population	C. Two or more individuals of the same kind, occupying a specific area.
____ 4. Extinct	D. Limited in number and protected by state laws from being disturbed.
____ 5. Endangered	E. Informal term for a very small or rapidly declining population at risk of extinction.
____ 6. Protected	F. To return to a former state of health existence.
____ 7. Threatened	G. Informal term indicating that USFWS has some concern for the future well-being of the species but does not grant it Endangered Species Act protection.
____ 8. Extirpated	H. To kill, collect or hunt an animal or plant illegally.
____ 9. Occurrence	I. A place where an animal or plant lives and obtains food, water and shelter.
____ 10. Range	J. A species that no longer exists in one geographic area but still survives in other areas.
____ 11. Limiting Factor	K. No longer living anywhere on the earth.
____ 12. Status	L. A geographical area in which a species of organisms lives.
____ 13. Restoration	M. Anything that interferes with or prevents a population from thriving.
____ 14. Conservation	N. Current state of a species' existence.
____ 15. Native Species	O. A group of organisms that can interbreed and produce more of their own.
____ 16. Poach	P. A naturally occurring species in an area.
____ 17. Restricted	Q. To exist or be present.
____ 18. Species of Concern	R. In great danger or at risk of ceasing to exist.
____ 19. Critically Impaired	S. An animal or plant that is likely to become endangered in the future throughout a significant part of its range.



Blackline Master #5

Extirpated? Don't You Mean Extinct? Vocabulary Tests and Map Answer Key

Vocabulary Test

1. O 2. I 3. C 4. K 5. R 6. D 7. S 8. J 9. Q
10. L 11. M 12. N 13. F 14. A 15. P 16. H 17. B 18. G 19. E

Answers to Mapping Activity:

Extirpated -

(RED)
Maryland
New York
Pennsylvania
Virginia

Threatened/Endangered/Critically Impaired

(YELLOW)
Minnesota
Nebraska
North Carolina
Ohio
Texas
West Virginia
Wisconsin

Stable with Fishing

(BLUE)
Arkansas
Illinois
Indiana
Iowa
Kansas
Kentucky
Mississippi
Missouri
Montana
North Dakota
Oklahoma
South Dakota
Tennessee

Protected/Stable

(GREEN)
Louisiana
Alabama

Blank - all other states (paddlefish apparently not present)



Journal Rubric – Extirpated? Don't You Mean Extinct?

Entry Topic: Explain what you know about the status of the paddlefish in the United States.

- _____ 0 pts. No effort – Nothing written.
- _____ 1pt. Student distinguishes between extirpated and extinct.
- _____ 2 pts. Student distinguishes among terms of existence and identifies the paddlefish as extirpated, protected and endangered in different states throughout the United States.
- _____ 3pts. Student distinguishes among different terms of existence, gives examples of states of each status and gives at least two possible causes of those status rankings.
- _____ 4pts. Student distinguishes among different terms of existence, gives examples of states of each status and gives at least two possible causes of those status rankings. Student describes restorative efforts of states.

Point Assignment _____

Date _____

Student Name _____



What a Nuisance!

Kathleen Nichols
DeRidder Jr. High
DeRidder, La.

Grade Level
Middle School (6-8)

Duration
One to two 45-minute
class periods

Subject Area
Inquiry
Life Science
Environmental Science
Creative Arts
Language Arts

Materials List

- *Oh No! Hannah's Swamp is Changing*
- Enviro-Tacklebox video, *Non-Native Invasion*
- Sample of brochures
- Various printed materials necessary to conduct research
- Construction paper or other paper for brochures
- Crayons or colored pencils
- Nonindigenous species list (BM #1)
- Brochure rubric (BM #2)

Grade/Benchmark/GLE Science
6-8/SI-M-A1/3
6-8/SI-M-A2/4
6-8/SI-M-A7/19
7/SE-M-A4/39
LS-M-C3
7/LS-M-C4/29
7/LS-M-D1/31
7/LS-M-D2/32,33
HS/SE-H-A6/7 (enviro sci)

Language Arts
6/ELA-1-M3/6
6/ELA-1M4/7
7,8/ELA-1-M3/4
7,8/ELA-1-M4/5
9,10/ELA-1-H3/4
9-12/ELA-1-H4/5

Creative Arts
CE-1VA-M2
CE-1VA-M3

BM = Blackline Master

Focus/Overview:

Students of all ages love to listen to stories read aloud. Through the book *Oh No! Hannah's Swamp is Changing*, students will be introduced to an ever-growing problem facing Louisiana today. The purpose of this lesson is to introduce students to nonindigenous, or non-native, species found in Louisiana. Students will research a specific nonindigenous plant or animal and use the information to create a brochure to present to the class. Students will then use the information to infer how these non-native species affect native populations, including paddlefish.

Background Information:

Nonindigenous species are plants and animals that live outside their natural geographic boundaries. They are called by many other names: exotic, introduced, non-native and nuisance. Humans have intentionally introduced some of these organisms for agriculture, the garden and pet industries, and fish and wildlife management. Some have entered accidentally in ships ballast water, in packing materials, as hitchhikers on other plants and animals, or even in hurricanes.

When these nonindigenous species make their way into natural ecosystems, they can threaten native habitats and the organisms that live there. Once established, nonindigenous species can displace native plants and animals, alter ecosystems, cause disease and interfere with industry, agriculture and recreation.

The Gulf Coast region has been particularly susceptible to the invasion of many nonindigenous species due to its major shipping corridors and mild climate.

Learning Objectives:

Students will:

- Define nonindigenous species.
- Conduct research on at least one nonindigenous species found in Louisiana.
- Infer how native populations are affected by nonindigenous species, especially paddlefish.



Procedure:

Introduce a nonindigenous species to the class by reading the book *Oh No! Hannah's Swamp is Changing*. Ask students to brainstorm meanings of unfamiliar words. Develop a list of these words so students can operationally define them as the lesson progresses.

1. Distinguish between nonindigenous species and native species. Have students predict how nonindigenous species may have been introduced to a new area and some of the problems that may develop as a result of their introduction. Record these ideas either in front of the classroom or have students record them in their student journals.
2. View the Enviro-Tacklebox video *Non-Native Invasion* (or another similar video containing information about the impact of invasive species). Discuss the impact and control of invasive plant and animal species.
3. Distribute samples of brochures to students and discuss the similar elements of the brochure format. Note: Brochures can be on other subjects besides nonindigenous species.
4. Students will choose a nonindigenous plant or animal species found in Louisiana that interests them from the list (BM #1). Have students create original brochures containing the following information:

- Place of origin of the plant/animal
- Method of arrival (known or speculated)
- Background information on the plant/animal species
- Problems caused (if any) by the plant/animal
- Identifying features
- Prevention and control

Bonus questions:

- What features does this species have that allow it to reproduce rapidly, affecting the success of the population?
 - What characteristics does this plant or animal have that make it an opportunist here?
5. Students will present their brochures to the class. Discuss characteristics that these nonindigenous species have in common. Discuss the impacts these species have on native species. Suggest potential effects on paddlefish.

Assessment:

Use rubric to assess brochures. (See BM #2.)

Extensions:

- Students can investigate nonindigenous species that are found locally and create posters to alert the public to be on the lookout for these plants or animals.
- Students can create a slide presentation to share with other teachers and students using the information they found on nonindigenous species.
- Students can research and compare nonindigenous species problems outside of Louisiana. Are there native species here that are a problem elsewhere? What species? Example: Smooth cordgrass (*Spartina alterniflora*)
- Students can hypothesize methods of eradicating nonindigenous species, design experiments to test their hypotheses, and communicate their findings to the class.



TEACHER REFERENCES:

Publications

Barrett-O'Leary, M. 2002. *OH NO! Hannah's Swamp is Changing*. Louisiana Sea Grant College Program: Baton Rouge, LA. 30 pp.

Hannah the heron experiences changes in the swamp she lives in when a non-native plant begins growing and spreading. To order, call (225) 578-6448, or email jsche15@lsu.edu, cost \$10.00.

Be on the Look Out...: Invasive Species on the Move in Louisiana (brochure). 2002. Louisiana Sea Grant College Program: Baton Rouge, LA.

Focuses on invasive species that threaten habitats and ecosystems. Includes photographs and a brief profile of various threatening species. To order, call (225) 578-6448, or email jsche15@lsu.edu.

Nonindigenous Species Activities for Youth. Mississippi State University Extension Service publication #2286. 78 pp.

Activities geared to help students understand what exotics are and the impact they have on an area. Profiles of selected species are also provided.

Soniat, L. 1996. *Project TELLUS Teaching Modules for Global Change Issues: Exotic Species*. Louisiana Sea Grant College Program: Baton Rouge, LA.

Understanding Invasive Aquatic Weeds. Aquatic Plant Management Society, Inc. Vicksburg, Miss. 2002. 15pp.

Activity book to increase awareness of the importance of native plant in lakes, rivers and wetlands, and the destructive potential of invasive weeds to these areas.

Wetland and Invasive Plants of the Southeast. University of Florida Center for Aquatic and Invasive Plants. University of Florida publication # SP276. 37pp.

Coloring book includes drawing of 59 native wetland plants of the southeastern United States.

Multimedia

Louisiana Public Broadcasting Television Network. *Enviro-Tacklebox Module #3: Non-Native Invasion* (video). 2000. Ordering information at <http://www.envirotacklebox.org>.

Internet sources

The Bridge, Ocean Sciences Education Teacher Resources. *Exotic Species*. <http://www.vims.edu/bridge/exotic.html>. Accessed June 14, 2004.
Numerous links to exotic species sites.

Louisiana Sea Grant College Program. *LaMER: Louisiana Marine Education Resources Gateways to Aquatic Science*. <http://lamer.lsu.edu/>. Accessed June 14, 2004.

Aquatic education projects, classroom resources and aquatic links.

National Aquatic Nuisance Species (ANS) Task Force. *Aquatic Nuisance Species*.

<http://www.anstaskforce.gov/species.htm>. Accessed June 14, 2004.

This site has profiles of selected aquatic nuisance species.

National Invasive Species Council. *Invasivespecies.gov*.

<http://www.invasivespecies.gov>. Accessed June 11, 2004.

Profiles terrestrial plants and animals, aquatic plants and animals and microbes.



National Sea Grant College Program and the Great Lakes Sea Grant Network. *Sea Grant Nonindigenous Species Site (SGNIS)*. <http://sgnis.org>. Accessed June 14, 2004. Research publications and educational materials on aquatic nuisance species, including links to other related sites.

Wisconsin Department of Natural Resources. *Alien Invaders, "EEK! Environmental Education for Kids"*. <http://www.dnr.state.wi.us/org/caer/ce/eeek/earth/aliens.htm>. Accessed June 4, 2004. Environment and environmental issues – spotlights alien species in Wisconsin.



Blackline Master #1

Nonindigenous Species List

Plants	
Aquatic	Terrestrial
Alligatorweed (<i>Alternanthera philoxeroides</i>)	Chines tallow (<i>Sapium sebiferum</i>)
Common salvinia (<i>Salvinia minima</i>)	Cogon grass (<i>Imperata cylindrical</i>)
Giant salvinia (<i>Salvinia molesta</i>)	Kudzu (<i>Pueraria montana</i>)
Hydrilla (<i>Hydrilla verticillata</i>)	Torpedograss (<i>Panicum repens</i>)
Purple loostrife (<i>Lythrum salicaria</i>)	
Water hyacinth (<i>Eichhornia crassipes</i>)	
Water lettuce (<i>Pistia stratiotes</i>)	
Animals	
Aquatic	Terrestrial
Asian clam (<i>Corbicula fluminea</i>)	Africanized honey bees (<i>Apis mellifera scutellata</i>)
Bighead carp (<i>Hypophthalmichthys nobilis</i>)	Argentine fire ants (<i>Solenopsis invicta</i>)
Black carp (<i>Mylopharyngodon piceus</i>)	Formoson termite (<i>Coptotermes formosanus</i>)
Brown mussel (<i>Perna perna</i>)	Nutria (<i>Myocaster coypus</i>)
Chinese mitten crab (<i>Eriocheirus sinensis</i>)	
Grass carp (<i>ctenopharyngodon idella</i>)	
Green crab (<i>Carcinus maenas</i>)	
Marine swimming crab (<i>Charybdis hellerii</i>)	
Rio Grande cichlid (<i>Cichlasoma cyanoguttatum</i>)	
Round goby (<i>Neogobius melanstomus</i>)	
Silver carp (<i>Hypophthalmichthys molitrix</i>)	
Spotted jellyfish (<i>Phyllorhiza punctata</i>)	



Blackline Master #2

Exotic Species Brochure Rubric

Name: _____

Date: _____

CATEGORY	5	4	3	2	1	Student Evaluation	Teacher Evaluation
Required Elements	The brochure includes all six required elements as well as additional information.	Five - six required elements are included in the brochure.	Four required elements are included on the brochure.	Three - two required elements are included on the brochure.	One required element is included in the brochure.		
Content/ Accuracy	All facts in the brochure are accurate.	99-90 percent of the facts in the brochure are accurate.	89-80 percent of the facts in the brochure are accurate.	79-70 percent of the facts in the brochure are accurate.	Fewer than 70 percent of the facts in the brochure are accurate.		
Graphics/ Pictures	Graphics go well with the text and at least five graphics have been included.	Graphics go well with the text and at least four graphics have been included.	Graphics go well with the text and at least three graphics have been included.	Graphics go well with the text and at least one - two graphics have been included.	No graphics have been included.		
Attractiveness Organization	The brochure has exceptionally attractive formatting and well-organized information.	The brochure has attractive formatting and well-organized information.	The brochure has well-organized information.	The brochure's formatting and organization of material are confusing to the reader.	The brochure lacks any organization.		
Timeliness	The brochure was turned in on time.	The brochure was turned in one day late.	The brochure was turned in two days late.	The brochure was turned in three days late.	The brochure was turned in more than three days late.		
Student Comments						Total points:	Total points:
Teacher Comments							

Tracy Armand
Grolee Elementary
Opelousas, La.

Grade Level
Middle School (6-8)

Duration
2 to 3 45-minute class
periods

Subject Area
Inquiry
Life Science
Environmental Science
Social Studies

Materials List

- Plastic tub, wallpaper trough or similar pan
- Sand
- Modeling clay
- Small rocks
- Small containers for pouring water
- Packing peanuts or other small, floating objects to represent paddlefish
- Building blocks

Grade/Standard/GLE Science

6-8/SI-M-A5/14, 16
6-8/SI-M-A3/7
7/SE-M-A4/39
7/LS-M-D2/32

Math

8/G-1D-M1/14

BM = Blackline Master

Do Dams Affect the Paddlefish Population ?



Focus/Overview:

Students will learn about dams – what they are, why they are built and what is affected by them.

Students will construct models of dams and infer how dams may adversely affect the paddlefish population.

Background Information:

A dam is a structure that blocks or diverts the flow of water. Dams have been used for thousands of years; the oldest were built more than 5,000 years ago in the Middle East to irrigate crops. Today, there are more than 500,000 dams in the world. They are built for many reasons, but mostly to control water flow during droughts or floods, to store water for drinking and irrigation and/or to generate electricity.

Before a dam can be built, a planning process involving the project developer, local, regional and federal officials, and the public occurs. Decisions must be made on the dam's structure, location, impacts, costs and benefits. A dam must be high enough to control flood waters and strong enough to hold back river water. The location of the dam must be evaluated to ensure that the benefits are greater than the costs. Dams are very expensive to build. Construction requires a large labor force and large quantities of building materials such as steel and concrete. The area also must be excavated to build a sturdy dam. In some cases, some existing structures on the site must be relocated while others such as roads, trees and buildings are buried underwater.

Once a dam is completed, the surrounding environment is significantly altered, and all forms of life in the local vicinity, including paddlefish, are affected. Dams form reservoirs with deep water and slow currents, which is ideal habitat for paddlefish most of the year. Unfortunately, dam reservoirs can destroy areas that were once ideal paddlefish spawning areas by reducing water flow and inundating clean gravel bars. In general, dams have had a negative affect on paddlefish populations because they create barriers that prevent migration to spawning grounds.

When biologists re-establish a paddlefish population in an area that has been altered by a dam, they stock fingerlings above the dam. This allows the paddlefish to migrate to spawning areas further upriver. Sometimes paddlefish will travel 100 to 200 miles to find ideal habitat for spawning.



Although paddlefish fingerlings are placed above the dam, they may not remain there through adulthood. Biologists have discovered that in the fingerling's first year, there is a 50 percent chance that it will travel through the dam to the waters below because of its small size.

Toledo Bend Dam and Generating Complex is a good example of a dam that has altered paddlefish habitat and where a restocking program has been successful. Built on the Sabine River, this dam has two hydroelectric power generators, one each in Texas and Louisiana. These generators together produce 205 million kilowatt-hours of electricity annually. The purpose of this dam is to produce electricity, to maintain water supply and support recreation, especially for game fishing. The Toledo Bend Reservoir covers 185,000 acres of land, is 65 miles long and 15 miles wide. It is the largest human-made body of water in the south.

Before the dam was built, the area that is now the reservoir contained many gravel bars, ripple areas and three waterfalls, which are ideal for paddlefish spawning. Unfortunately, pre-dam biological surveys were conducted only during the summer months when paddlefish are typically farther downstream in the coastal areas of the Sabine River. Consequently, these surveys have no record of paddlefish inhabiting the river near the dam's location, because paddlefish only use the area in the early spring to spawn. After spawning, the fish return downstream to areas with deep, slow-moving water.

In 1990, Texas Parks and Wildlife and the Louisiana Department of Wildlife and Fisheries worked together to restock paddlefish in the Toledo Bend Reservoir. Each agency committed to stock paddlefish fingerlings for 10 years. Texas began its stocking program in 1990 and Louisiana in 1991. The result of this joint effort is a healthy population of paddlefish above the Toledo Bend dam.

Once stocked, some paddlefish fingerlings move below the dam into Sabine Lake. These fish are unlikely to spawn because there is no suitable spawning habitat below the Toledo Bend dam. The one chance these fish have to spawn occurs during high water when the Toledo Bend Spillway is open. Under these conditions the fish in Sabine Lake may move up the Neches River in Texas where spawning habitat can support a small population of paddlefish.

Learning Objectives:

Students will:

- Construct models of dams.
- Examine a series of maps to determine the impact of dam construction over time.
- Examine maps of paddlefish distribution over time.
- Infer how dams may affect the paddlefish population.

Procedure:

1. Begin the lesson by asking students to recall the critical conditions for paddlefish spawning. (See Lesson "Critical Conditions for Paddlefish Spawning"). Tell students that they will focus on the environment of the paddlefish – the river system.
2. Students brainstorm and share what they know about the water conditions necessary for spawning.



3. Challenge students to create a model of such a system in a pan. Allow time for students to create and share their working models. Provide such materials as pans, sand, modeling clay, small rocks and water to create models. Also provide packing peanuts or other small, floating objects to allow the students to illustrate the capability of their river system to provide adequate spawning migration area for their paddlefish.
4. Once all groups have demonstrated their models, students will record in their journals their ideas about how humans have altered river systems. Students will lead a class discussion, recording their ideas on a bulletin board or poster. In addition, discuss whether the rivers were altered to purposefully harm the environment.
5. Tell students that their state is considering constructing a hydroelectric power plant as an alternative energy source for their area. They have been charged with considering the impact of the construction of the dam on their river system. Challenge students to return to their river models and construct a dam within their system. Provide them with a variety of materials and sufficient time to construct and test their models. Students record in their journals the changes to their system's structure and function.
6. Schedule a simulated town meeting. Students, as citizens of the town and other interested parties, must present their points of view. Some students will represent a company contracted to construct a dam; some represent biologists arguing that it will affect the natural environment; and others represent various parties of interest. Require evidence to support arguments in the simulated event, where appropriate. Students should demonstrate their working dams and share their findings, including their ideas on the benefits and/or risks to the environment as appropriate to their assigned role in the simulated event. Encourage students to use their models to support their positions where appropriate.

Review:

1. Why are dams useful?
Dams provide a large containment of water for consumption, irrigation of crops, control of floods and drought resistance.
2. How did the flow of your river system change after the construction of the dam?
Accept any reasonable answer with supporting evidence.
3. Why might dams affect paddlefish populations?
They create barriers for paddlefish spawning migration.
4. Is it possible for dams and paddlefish to coexist in the same river system?
Accept any reasonable answer with supporting evidence.



Assessment:

- Construction of dams
- Participation in the simulated event
- Responses to the review questions
- Journal entries assigned throughout this lesson

Extensions:

- Provide students with current and historical maps of paddlefish distribution and dam development over the same area. Use the Minnesota Department of Natural Resources site, <http://www.nativefish.org/Articles/Paddlefigures.htm>. It contains many historical maps of paddlefish distribution.
- Students examine locations of paddlefish populations over time, cross-referencing their findings with the locations of dams in the same area over time.
- Take a closer look at an area in Louisiana, Toledo Bend Reservoir, where paddlefish spawning habitat was altered. See BM's #1, 2, 3, 4 and 5 to see how the Toledo Bend Dam and Generating Complex on the Sabine River has altered surrounding habitat. Use the background information to explain how paddlefish habitat changed and describe the effect on the population.
Note: For clearer viewing of Blackline Masters use digital copies on the *Native Fish in the Classroom* CD or online at <http://www.lamer.lsu.edu/projects/nativefish/index.htm>.

TEACHER REFERENCES:

Internet sources

"An American Journey." Jackson Times. <http://www.pasorobles-usa.com/paddlefish.htm>.
Accessed January 21, 2004.

Article describes the journey of a tagged paddlefish that crossed dams.

Aswan High Dam. <http://teacherlink.ed.usu.edu/tlresources/units/byrnes-africa/KAYMUR/>.
Accessed January 21, 2004.

Lesson plan with additional background information.

ESPN Outdoors News Service. 2001. Paddlefish Pounds Pavement to Kentucky.
<http://proxy.espn.go.com/outdoors/fishing/news/2001/0808/1236866.html>.
Accessed January 21, 2004.

Frequently Asked Questions. U.S. Geological Survey Upper Midwest Environmental Sciences Center.
www.umesc.usgs.gov/aquatic/fish/paddlefish/faq.html. Accessed January 21, 2004.
Map of the present distribution of paddlefish in the United States and the effect of river modifications.

Haddens LA-TEX Quadrangle. U.S. Geological Survey 1954, 1969, and 1984.

Jackson, Donald C. and Gerd Marmulla. The Influence Of Dams On River Fisheries.
<http://www.fao.org/DOCREP/004/Y2785E/y2785e02a.htm>. Accessed January 21, 2004.



- Minnesota Department of Natural Resources. Element Occurrence Records of Paddlefish.
<http://www.nativefish.org/Articles/PaddleFigures.htm>. Accessed July 31, 2004.
Maps of occurrence of paddlefish with observations dated 1899 – 1995. Includes indications of dams and other structures.
- Missouri River Adopt-A-Fish. Ask A Biologist.
<http://www.walleyesunlimited.com/adopt-fish/askbiologist.html>. Accessed January 21, 2004.
Describes effects of dams on paddlefish.
- Paddlefish Project Overview. U.S. Geological Survey Upper Midwest Environmental Sciences Center.
<http://www.umesc.usgs.gov/aquatic/fish/paddlefish/video.html>. Accessed January 21, 2004.
Six-minute comprehensive video overview of the USGS Paddlefish Project, including the impact of dam construction.
- Sabine Parish Office. Toledo Bend Dam & Reservoir. <http://www.sabineparish.com/attract/toledo.asp>.
Accessed September 10, 2004.
Information about the reservoir, hydroelectric generators and cost of construction, plus a graphic of the generator.
- Sabine River Authority of Texas. Toledo Bend Project. <http://www.sra.dst.tx.us/projects/tbp.asp>.
Accessed September 10, 2004.
History of construction, the dedication and current weather conditions.
- Schmidt, Konrad. The Distribution and Status of Paddlefish (*Polyodon spathula*) in Minnesota.
Minnesota Department of Natural Resources.
<http://www.nativefish.org/Articles/PaddlefishDistribution.htm>. Accessed July 31, 2004.
This site accompanies the elemental occurrence maps from the Schmidt link.
- Sim Science. Cracking Dams. <http://simscience.org/cracks/index.html>. Accessed July 31, 2004.
Introduction to civil engineering and the construction of dams.
- Texas Extension. Wildlife Distribution.
<http://texas-extension.tamu.edu/agcom/multimed/wildlife/endanger/paddle2.html>.
Accessed July 31, 2004.
Map of main and possible paddlefish distribution in the United States.
- Toledo Bend Lake, Dam and Generating Station.
http://www.toledo-bend.com/toledo_bend/index.asp?request=tolbenddam.
Accessed September 10, 2004.
Facts about the dam and power plant.



Blackline Master #2

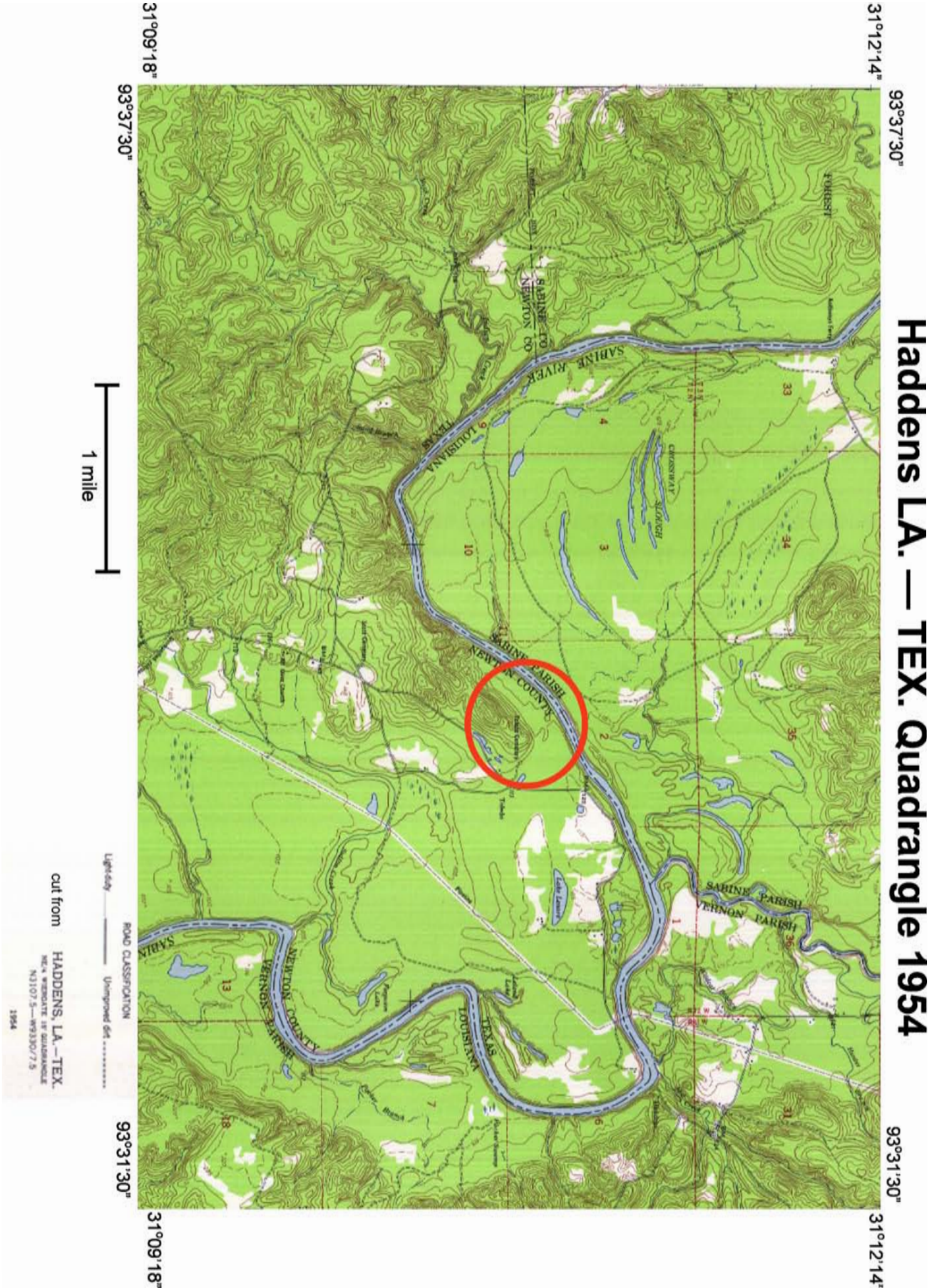



Blackline Master #3

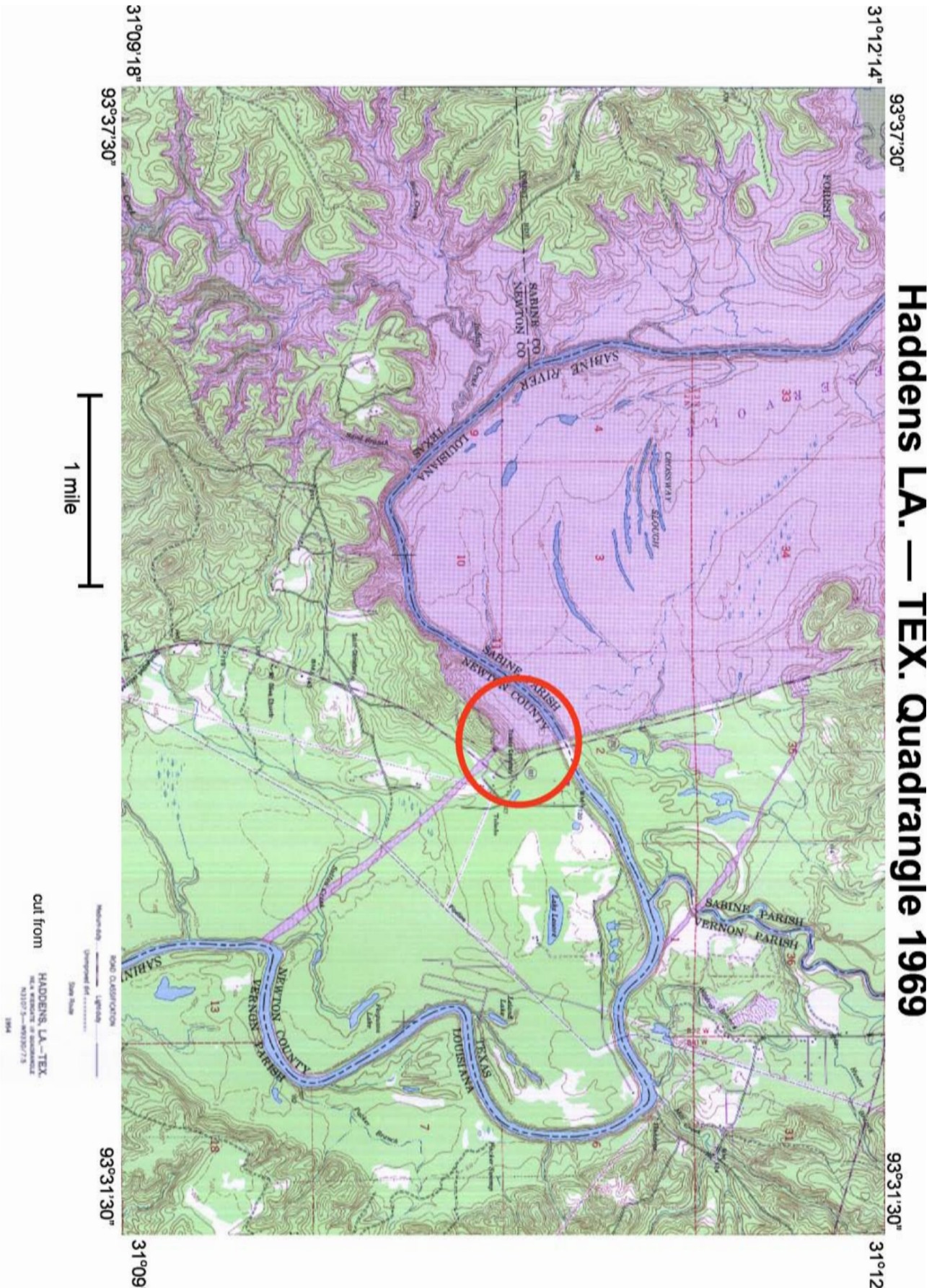



Blackline Master #4

Haddens LA. — TEX. Quadrangle 1985

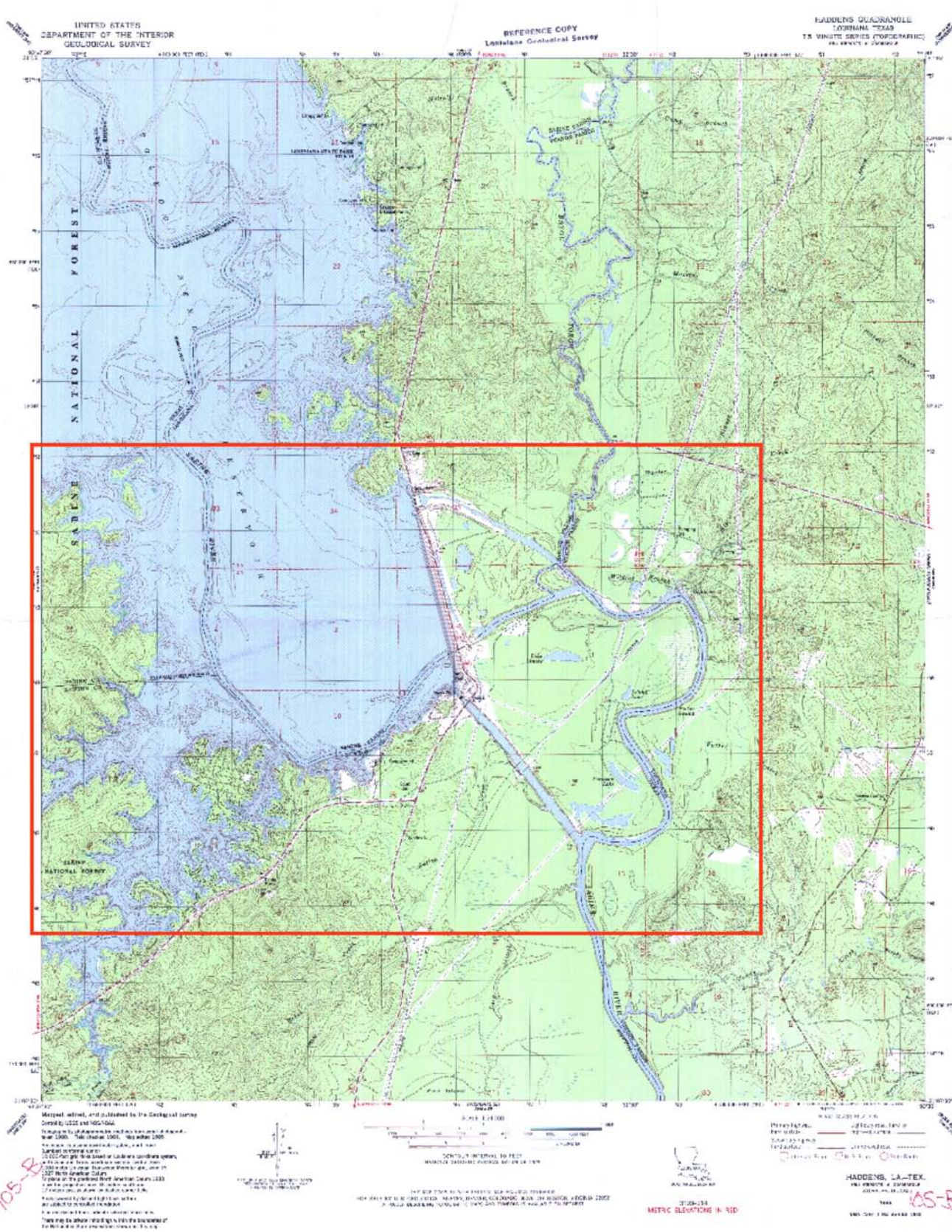

Sabrina Ardoin
Krotz Springs Elementary
Krotz Springs, La.

Grade Level:
Middle School (6-8)

Duration:
30 minutes, once weekly
for six to eight weeks.

Subject Area:
Inquiry
Physical Science
Math

Materials:

- Flat surface metric ruler
- Beaker
- Petri dishes
- Pipette
- TV/VCR w/ blank tape
- Paddlefish eggs, fry and/or fingerlings
- Video microscope
- Chart paper
- Pencils, colors
- Transparency sheet
- Fine-tip marker
- Construction paper
- Tape
- Blackline Masters

**Grade/Benchmark/GLE
Science**

6-8/SI-M-A3/6-8
6-8/SI-M-A4/11-13
6-8/SI-M-A5/16
HS/SI-H-A2/4
HS/PS-H-A1/2 (phys sci)

Math

6/M-1-M/18
M-6-M
8/D-1-M/34,35
6/D-2-M/30
7/D-2-M/33
8/D-2-M/41
11,12/D-1-H/17
9/D-7-H/28
10/D-7-H/22

BM = Blackline Master

How Fast Do Paddlefish Grow?



1 of 12

Focus/Overview:

Students will actively collect, record and display data relating to the growth of paddlefish fry using the proper equipment and methods. Students will measure the lengths of members of a sample population of paddlefish to determine growth over a specific period of time. Their findings will be presented in student-created charts and graphs and in written and oral presentations. All measurements will be in metric units mimicking the work of the scientific community.

Background Information:

Paddlefish are rapid growers. They begin as eggs, roughly 2 to 3 mm in diameter, and grow into fingerlings, 25-30 mm long, in just a few weeks.

Paddlefish, one of the largest fish in the United States, can grow to an amazing total length of 2m (7ft) and may weigh up to 91 kg (200 lbs). Studies have found the growth of young paddlefish averages approximately 2.5 cm (1 in) per week, based on environmental conditions. While researchers have noted variances in length and weight from location to location, these differences are not significant.

The rostrum of a paddlefish begins to grow at the end of the fry stage. The rostrum of a fingerling is about half its total body length, but as the paddlefish reaches maturity that ratio changes to about one-third of the total body length. Total body length of a paddlefish is not measured to include the rostrum because it can vary, and there are many hazards that paddlefish may encounter in which damage to the rostrum can occur.

Learning Objectives:

Students will:

- Use mathematics and appropriate tools and techniques to gather, analyze and interpret data gathered during experimentation.
- Develop descriptions, explanations and graphs using collected data.



Procedure:

Set up: Recording growth from one week after hatching

Before recording:

1. Set up TV/VCR in an area that provides room to work. Prepare the equipment according to the manufacturer's instructions.
2. Set up the video microscope to record, and connect it to the TV/VCR following the manufacturer's instructions.

Focus: Activity 1 — Developing method to measure growth.

Instruct students to examine paddlefish eggs, recording their observations in science journals. Show them a picture of an adult paddlefish (BMs #1 and #2).

Ask, "How long do you think it takes a paddlefish to grow from an egg into a fry? To a fingerling? To an adult? How fast do you think this fish grows?" Allow time for discussion. Ask, "What tools could we use to measure them? What problems do you think we might encounter? What do we have to consider for the safety of the paddlefish? How can we prevent mortality and avoid other problems?" Allow more discussion.

Eventually students may come to the conclusions that: 1) the paddlefish must be kept wet to live; 2) they swim too fast for just the eyes to judge the length; and 3) they may vary in size from one fry to the other. Students predict growth and make a list of tools they could use.

Modeling:

Explain that a sample population is a small group that is representative of an entire population. Demonstrate for students the procedure for measuring the lengths of a sample population, how to record the data, and model the average of the outcomes to get an approximate length of the population. During the demonstration the teacher will model the "Eye-to-Fork" length measurement technique. Measure from the eyespot to the fork of the tail. See the diagram below.

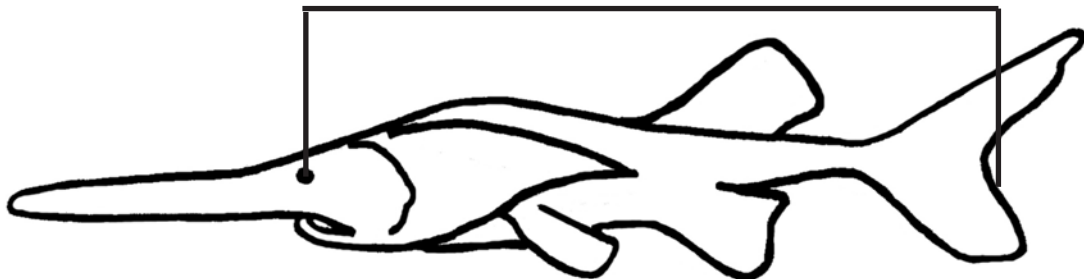



Activity 2 — Sampling and measurement

One week after hatching, and every week thereafter for eight weeks, students will measure the sample population as described above. Throughout the procedure, students will record their observations in their science journals.

1. Students spend about five to 10 minutes observing fry swimming in a petri dish. Ask students to describe how the fish behave.
2. Place the ruler on the table top on a piece of dark paper. Focus the video microscope on the ruler. Place a clean, rinsed petri dish on top of the ruler. Alternative TV ruler method, see BM #3, continue to follow the remaining steps.
3. Use a clean beaker to dip a random sample population from your tank. We use a sample size of five to 10 fry each time.
Caution: Be careful to avoid touching your hands to the water; even clean hands may have contaminants, such as soap, that may adversely affect the aquaria and even kill the population.
4. Carefully pour the population sample into the petri dish (on top of the flat ruler). Reduce water volume to limit movement.
5. Record the population sample with the video microscope and VCR until the whole sample has moved across the ruler and been recorded. For alternative method: freeze fry on the screen by pressing the record button, then use the TV ruler to make measurements, and skip steps #7 and 8. Students observe closely for the shortest time possible to minimize stressing the sample population.
6. Reintroduce the sample population into the tank by gently pouring them from the petri dish back into the tank.
7. Rewind the tape.
8. Play the tape. Pause for each individual and measure eye-fork length of each fry (from eyespot to fork in the tail).
9. On a student-made chart in their journals, students record the individual measurements of each fry. Include the date, time of day and the measure of each individual fry in metric units. Also include weekly average length and weekly growth rate (BMs #4 and 5).
10. Find the average length of the paddlefish fry for each week. Add the lengths of the fish sample population together and divide by the number of fish measured. Record the average on student-made chart.



11. Repeat this procedure weekly or biweekly for the duration of the project.
12. As data are collected, students will graph the average length of the population sample on a student-created graph (BM # 6).
13. After two weeks of measurements are collected and averaged, calculate the growth rate, which is the difference in the average population length between the previous week and the present week. Enter growth rate on a data collection sheet.
14. Create a graph showing the population's rate of growth as the data become available (BM # 7).
15. Draw conclusions. Examine your graphs and make a statement about growth rate.

Note: The following Blackline Masters (BM #4, 5, 6 and 7) may be used for this lesson. However, students should be encouraged to construct their own data tables and graphs independently, correctly labeling variables.

Important points in lesson:

1. What is a sample population?
A small group that represents the characteristics of the whole group.
2. How is the average length of a sample population determined?
By adding the lengths of each member of the sample and dividing by the number of members.
3. How can we calculate the growth rate?
Subtract last week's average length from this week's average length.
4. Why should we use the eye-to-fork measures?
Because the fry, as well as adults, may have varying rostrum lengths.

Assessment:

Use rubrics to assess each student's data collection method and chart and graph construction (BM #8).

Students write weekly journal entries. (BM #8)

Extensions:

- Students design a procedure for determining growth in terms of weight for the paddlefish.
- Students measure the rostrum tip to eye length. Compare these measurements to the eye-fork length.
- Students draw pictures of the weekly changes in the morphology of paddlefish fry.



TEACHER REFERENCES:

Publications

Capello, Angela. *Booker Fowler Fish Hatchery and the Story of Finnie the Fingerling*. Louisiana Department of Wildlife and Fisheries Aquatic Education Program: Baton Rouge, La. A coloring/storybook depicting the hatchery's role in the development of specific species of fish, including the paddlefish.

Reed, Bobby. 1991. "Growth, Fecundity, and Mortality of Paddlefish in Louisiana," *Paddlefish Biology in Louisiana*. Louisiana Department of Wildlife and Fisheries: Baton Rouge, La. A comprehensive study of paddlefish in Louisiana.

Multimedia

Wills, Betty. *The Paddlefish: An American Treasure* (video). Earthwave Society: Fort Worth, Texas. This video addresses all facets of the life of paddlefish in the United States. It includes information on ongoing conservation efforts and methods, as well as the reasons for the decline of the population and current laws. Summary and ordering information at <http://www.earthwave.org/paddlefish.htm>. Cost \$24.95 plus shipping and handling.

Internet sources

Cooper, Calene. *Missouri State Aquatic Animal – Paddlefish Model Assembly*. Successlink. <http://www.successlink.org/great2/g661.html>. Accessed June 14, 2004. Lesson plan using model, background information on paddlefish and links to other paddlefish sites.

Paulson, Nicole and Jay Hatch. *Paddlefish*, *Polyodon spathula*. Minnesota Department of Natural Resources and U.S. Fish and Wildlife Service. <http://www.gen.umn.edu/research/fish/fishes/paddlefish.html>. Accessed June 14, 2004. Discusses the fishes of Minnesota. The site was designed for educational purposes and includes pictures, biology and reasons for paddlefish decline.



Blackline Master #1

Adult Paddlefish



Photo courtesy Richard Condrey



Paddlefish Eggs



Photo by Bobby Reed



Fry

Photo by Bobby Reed

Fingerling

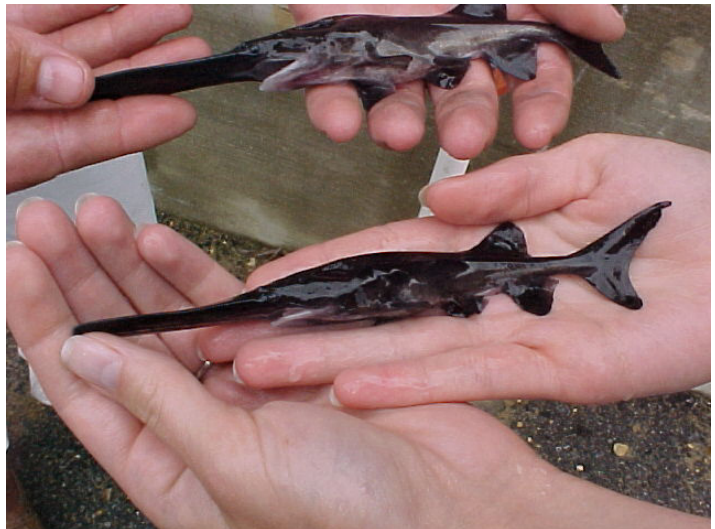

Photo by Rachel Somers



Blackline Master #3

Making a SOAR TV Ruler

How to measure critters you see on TV with Scope-on-a-Rope

1. Tape a transparency sheet to the TV screen.
2. Scope a ruler (in millimeters) with the 30X lens.
3. Record image by pressing the RECORD button.
Play the recorded image back by pressing the PLAY button.
4. Use a marker to trace the millimeter divisions onto the transparency.
5. On your transparency, write the unit size (1 mm for the 30X), the lens magnification 30X, and the diagonal measurement of your TV screen (e.g., 13, 19, or 25 in).

Note: For your measurements to be correct, you must always use your micro ruler with the indicated lens magnification and TV diagonal size.

6. Scope an object. Line up the transparency on the image and use your new TV ruler to measure your object.

Note: You can make a grid on another transparency for calculating area. Remember to record the three important pieces of information on your micro grid: unit size, lens magnification and diagonal measurement of your TV screen.





Blackline Master #4 Student Name _____

Average Population Length

Date of Sampling	Time	Length of Sampled Members in mm	Average Length of Population Sampled

Blackline Master #5 Student Name _____

Weekly Growth Rate Data

Date of Sample One	Average Length of Sample One	Date of Sample Two	Average Length of Sample Two	Growth (Difference in Wk 1 and Wk 2)



Blackline Master #6

Student Name _____

Graphing Average Weekly Paddlefish Length

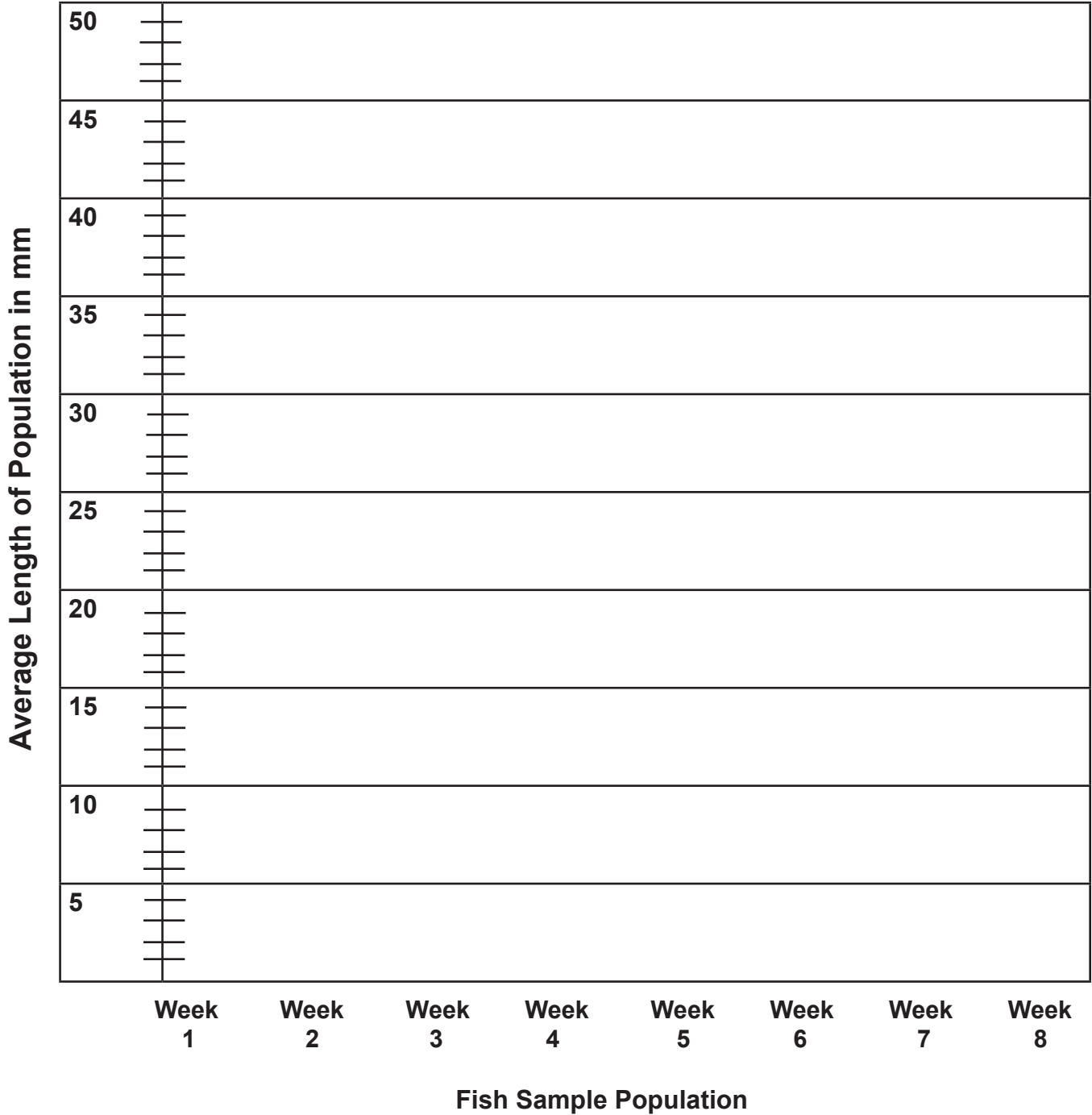



Student Name _____

Graphing Growth Rate

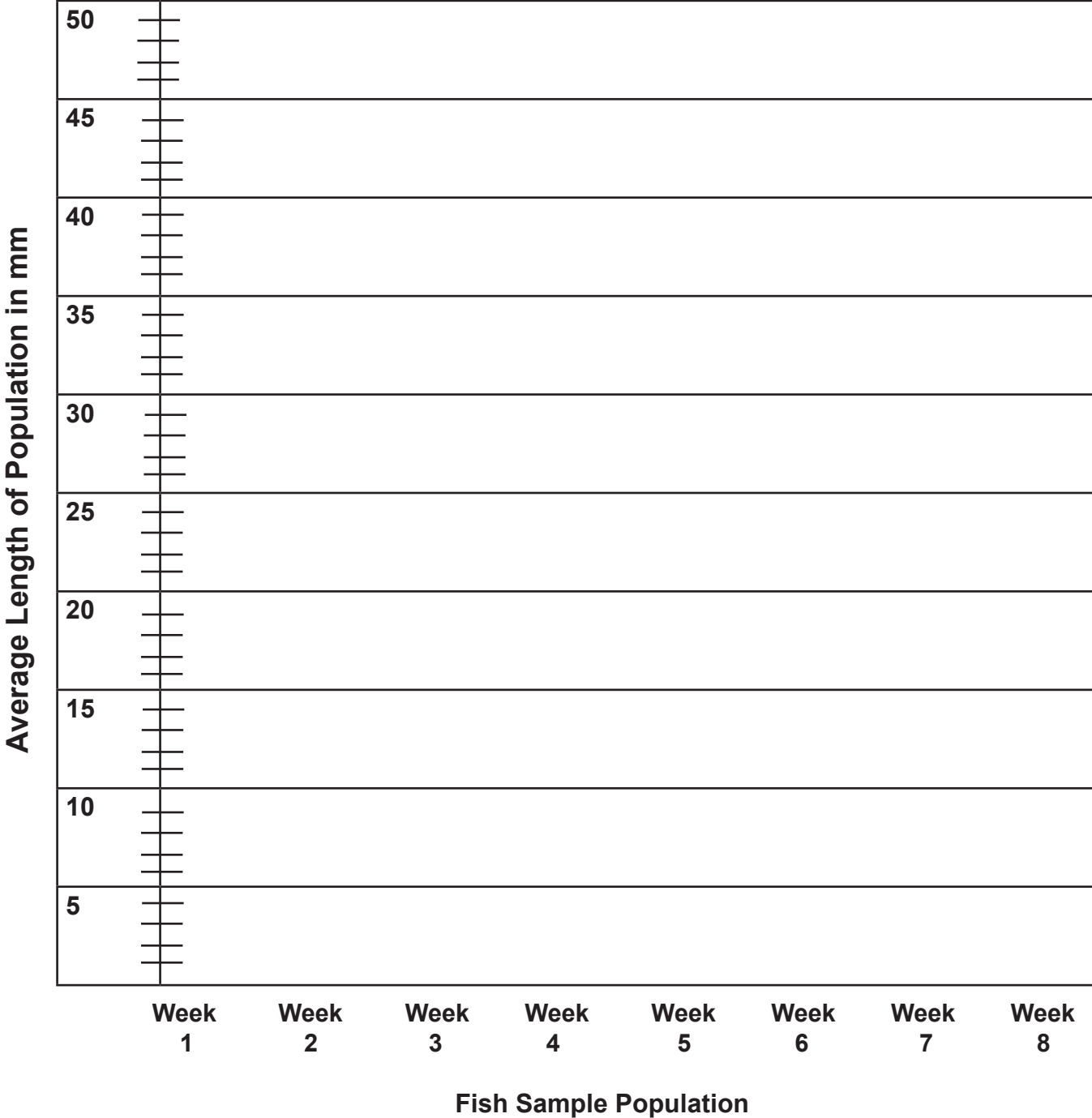



Journal Rubric – How Fast Does A Paddlefish Grow?

Entry Topic: Observations, data, charts and graphs of paddlefish growth and conclusions drawn by students.

- _____ 0 pts. No effort – nothing written.
- _____ 4 pts. Student makes good observations noting changes in morphology of the fish, not limited to and including drawings and written descriptions.
- _____ 4 pts. Student collects data in chart form.
- _____ 4 pts. Student constructs bar graph of weekly average population growth.
- _____ 4 pts. Student constructs a line graph depicting change in average population length over time.
- _____ 4pts. Student draws logical conclusions based on recorded data, in paragraph form.
- _____ 2 pts. Student's work is neat and easy to read.

Point Assignment _____

Date _____

Student Name _____

Total possible points: 22

Lyn Murphy
Tioga Junior High
Tioga, La.

Grade Level
Middle School (6-8)

Duration
One 45-minute class
period

Subject Area
Inquiry
Life Science

Materials List

- Video microscope
- TV
- VCR, blank tape
- Books, see references
- 3 computers, see observation stations
- BioQuest Frog Development Kit teacher/student guide (Walz 1996)
- Hard-boiled chicken egg (for size comparison)
- Metric rulers
- Magnifying glasses
- Chart and questions (BM #1-3)
- "Life History and Management of Paddlefish" (Reed 2003)
- Images of frog, chick and paddlefish development
- Teacher/class-made video of paddlefish egg development

Grade/Benchmark/GLE Science
6,7,8/SI-M-A3/6,7
7/LS-M-A3/6
HS/LS-H-C1/15 (biology)

BM = Blackline Master

Comparing Eggs and Embryos



1 of 7

Focus/Overview:

The purpose of this lesson is to learn about eggs and embryos by observing paddlefish, chicks and frogs. Students will observe a videotape of paddlefish development, paddlefish eggs in the classroom tank, computer images of frog and chick embryos from *BioQuest Frog Development Kit* and books with photographs of frog and chick embryos. They will complete a chart comparing the eggs and embryos.

Background Information:

Paddlefish, frogs and chicks are three organisms in which the embryonic development is easy to observe either directly or by viewing photographs. All are vertebrates, but paddlefish and frog hatchlings differ greatly from the adults, while chicks do resemble the adult chicken. While frogs and paddlefish eggs have a jelly-like covering, chicken eggs have a hard shell, and must be fertilized internally. Students need to understand that the shell is an adaptation for living out of the water. The hard shell prevents the egg from drying out. All three embryos have gills in the beginning, although they may be difficult for students to observe. All three have yolk sacs that nourish the embryo until it is able to feed independently.

Learning Objectives:

Students will:

- Develop an understanding of the similarities and differences among three vertebrate embryos.
- Use a variety of resources to find information on eggs and embryos.

Procedure:

Prepare before lesson:

When the teacher first acquires paddlefish eggs, the video microscope should be used to observe and record the paddlefish egg development. A VCR should be attached so that the development can be preserved for later viewing. Classroom time constraints may prevent students from directly observing all the stages prior to hatching.

Lesson setup:

1. Attention-grabber. Ask the students if they have observed metamorphosis in any animals, including frogs, moths or butterflies. Ask what they may know about the development of chicks in the egg.



During lesson:

2. Assign groups to study paddlefish eggs, frog eggs (*BioQuest* kit), and chicken eggs. Each group will study all three, rotating from one study station to another. Provide students with the “Comparing Eggs and Embryos” worksheet (BM #1) and “Worksheet Answer Key” (BM #2).

Lesson setup. Set up five stations for student rotation during the activity.

- A. TV/VCR with an in-class-made videotape of paddlefish development
 - B. Computer #1 with a bookmarked Web site on frog embryos (<http://www.erodent.co.uk/GardenPond/March2002.htm>)
 - C. Computer #2 with *Encarta* “Frogs”
 - D. Books on frog and chick embryology. (See BM #3.)
 1. *Chicken and Egg* (Back), Pages 11-25
 2. *Tadpole to Frog* (Owen), Pages 22, 24
 3. *A Frog is Born* (White), Pages 29-37
 4. *Frogs and Toads* (Zim), Pages not numbered
 - E. Computer #3 with Bobby Reed’s PowerPoint presentation, “Life History and Management of Paddlefish (*Polyodon spathula*) in Louisiana”
3. Students will rotate from station to station, make observations, answer questions and fill in the chart on the worksheet.

Assessment:

Students will take a brief quiz (BM #4) after a class discussion of their observations. (See BM #5 for Answer Key to quiz.)

Extensions:

- Raise tadpoles in the classroom and have students directly observe their development into frogs. Another option would be to raise chickens from eggs, although observation of the embryology may be somewhat limited.
- Students draw pictures of different stages of development for chicks, frogs and paddlefish during their observations and use them to observe similarities and differences.

References:

Teacher References (BM #3)



Name _____

Comparing Eggs and Embryos

Visit each station to observe and measure the eggs. Fill in the chart below.
Answer the questions on the back of this sheet.

Observation	Paddlefish eggs	Frog eggs	Chicken eggs
Size (diameter) – measure with a metric ruler			
Egg covering			
Yolk			

Questions:

1. Discuss the differences in the egg coverings of the frogs and paddlefish and chicken.
2. Based on what you already know about the size of the adult chick, frog and paddlefish and what you have observed about the embryos, is there a relationship between the size of the embryos and the size of the adults?
3. When the paddlefish eggs first started to divide, were they the same size as the cells in later divisions or different? If different, how are they different?
4. Compare the development of the paddlefish when it first hatches to that of the tadpole and the chick. How are they alike? How are they different?



Blackline Master #2

Answer Key

Observation	Paddlefish eggs	Frog eggs	Chicken eggs
Size (diameter) – measure with metric ruler	2 to 3 mm	0.5 to 3 mm	24 to 35 mm
Egg covering	Jelly-like	Jelly-like	Hard
Yolk	Still present when hatched	Still present when hatched	Large in comparison, gone when hatched

Questions:

1. Explain the significance of the differences in the coverings of the frog, paddlefish and chick.
Frogs and paddlefish spend all or part of their lives in the water, whereas the chick is adapted for living on land. Eggs of paddlefish and frogs are laid in the water, and chicken eggs are laid on land. Chicken eggs have a hard shell; paddlefish and frog shells are gelatinous and sticky.
2. Based on what you already know about the size of the adult chick, frog and paddlefish and what you have observed about the embryos, is there a relationship between the size of the embryos and the size of the adults?
No, the chick egg is much larger than paddlefish or frog eggs, but the paddlefish adult can get much larger. Frog eggs are similar in size to paddlefish, but adults frogs are smaller than both chickens and paddlefish.
3. When the paddlefish eggs first started to divide, were they the same size as the cells in later divisions or different? If different, how are they different?
The first cells are much larger than the cells in later divisions.
4. Compare the development of the paddlefish when it first hatches to that of the tadpole and the chick. How are they alike? How are they different?
When the chick hatches, it resembles a chicken but its feathers and wings are not fully developed. Newly hatched paddlefish do not yet have a rostrum, but do have a fishlike appearance, whereas tadpoles do not resemble the adult frog. The chick can eat on its own after hatching, but paddlefish and tadpoles must rely on the yolk for nourishment until mouthparts are developed.



Blackline Master #3

TEACHER REFERENCES:

Publications

Back, Cristine and Bo Jarner (photo). 1986. *Chicken and Egg*. 1st U.S. Ed. Silver Burdett Company: Morristown, N.J. pp 11-25.
Pictures for students use to fill in the chart about chicken development.

Owen, Oliver S. 1994. *Tadpole to Frog*. Abdo Consulting Group, Inc.: Minneapolis, MN. pp 22,24.
Information relating to variations in frog reproduction. Many photographs, including tadpole pictures.

White, William, Jr. 1972. *A Frog is Born*. Sterling Publishing Co.: New York, NY. pp 29-37.
Excellent source on frog embryology. Both the text and the pictures will be useful to students in filling in their charts.

Zim, Herbert S and Joy Buba. 1950. *Frogs and Toads*. William Morrow & Co.: New York, NY.
Drawings rather than photographs, but the text is especially useful to students.

Internet sources

Cebra-Thomas, Judy. *Overview of Chick Development*. Swarthmore College.
http://www.swarthmore.edu/NatSci/sgilber1/DB_lab/Chick/Chick_dev.html.
Accessed July 20, 2003.
College-level description of chick embryology, reference for teachers, although the site does include some images that might be helpful to students.

Gallon, Paula. *March 2002 and Frog Spawn Watch*. eRodent.
<http://www.erodent.co.uk/GardenPond/March2002.htm>. Accessed July 20, 2004.
This site has excellent pictures and may be used for one of the study stations.
Author has given permission to use the pictures.

Gallon, Paula. *March 2002 and Frog Spawn Watch*. eRodent.
<http://www.erodent.co.uk/GardenPond/Frogspawn.zip>. Accessed June 14, 2004.
This zip file provides a better quality version of the pictures to be used for one of the study stations. Author has given permission to use the pictures.

Jones, David. *The Frog and Pond Diary – March 2002*. My Bit of the Planet. Accessed July 20, 2004.
<http://www.mybitoftheplanet.com/2002/frogmarch.html#latest>.
Detailed photographs of tadpoles.

Miscellaneous resources

Reed, Bobby. "Life History and Management of Paddlefish (*Polyodon spathula*) in Louisiana."
PowerPoint presentation. Presented July 7, 2003. Inland Fish Division Louisiana Department of Wildlife and Fisheries. For a copy, contact Angela Capello, capelloa@centurytel.net, or Rachel Somers, rsomer1@lsu.edu.

Walz, Gari. *Bio-quest Frog Development Study Kit Teacher's Guide*. 1996. Nasco: Fort Atkinson, Wisconsin. Can be obtained from Fisher Scientific, p. 183, 2003-2004 catalog, \$78.00 Catalog # AJS11011. The teacher's guide and a student's guide come with with the plastic mounted Frog Development Study Kit. It is an excellent teacher reference, but may be too advanced for middle school students.



Comparing Eggs and Embryos Quiz Answer Key

1. Name three similarities between frog and paddlefish embryos.
 - a. jelly-like covering
 - b. yolk sac present
 - c. gills

2. Name a similarity between paddlefish embryos and chick embryos.

both have yolks

3. Explain the significance of a hard shell as an adaptation for living on land.

The hard shell prevents the embryo from drying out, if the egg is not in the water.
The hard shell also indicates that internal fertilization is necessary.

Kathleen Nichols
DeRidder Jr. High
DeRidder, La.

Grade Level
Middle School (6-8)

Duration
Six to eight weeks, if species
are raised simultaneously,
longer, if raised separately

Subject Area
Inquiry
Life Science
Environmental Science

Materials List

Mosquito –

- Mosquito kit
- Hand lens
- Microscope
- Deep-well slides
- Hand lens
- Metric ruler

Earthworms –

- Earthworm bin with
earthworms
- Hand lens
- Metric ruler
- Petri dish or lid
- Paper towels
- Toothpick

Paddlefish –

- Video – *The Paddlefish:
An American Treasure*
- Paddlefish eggs
- Paddlefish aquarium
- Incubation jar
- Petri dish or clear container
- Hand lens
- Microscope
- Metric ruler

Note: Only classrooms engaged
in the Native Fish in the Classroom
project will have access to
paddlefish eggs.

**Grade/Benchmark/GLE
Science**

7/LS-M-A3/5,6

SE-M-A7

6,7,8/SI-M-A2/4

6,7,8/SI-M-A3/7,8

6,7,8/SI-M-A4/10,12,13

6,7,8/SI-M-B2/28

9/SI-H-A4/7

LS-H-C6

BM = Blackline Master

Life Cycles of the Wet and Wiggly



1 of 8

Focus/Overview:

Three different species of living things will be raised in the classroom. Students will observe and compare the life cycles of each while seeing first-hand the development from egg to adult.

Background Information:

Real-life experiences in the classroom provide students with unique and interesting learning situations. One way to make these experiences available is to raise organisms in the classroom so students can observe the different stages in the life cycle of the organism.

Three organisms that have different developmental stages and can be raised in the classroom are mosquitoes, earthworms and paddlefish.

Mosquitoes:

Mosquitoes complete their life cycle relatively quickly. It takes about a month to complete, depending on the availability of water, the temperature and the species of mosquito.

Egg – When the weather is warm, mosquito eggs will hatch and develop into larvae within two to three days. Some species can hatch within hours, while others can take up to a week. If the eggs are not exposed to water, they can remain in a dormant state for several years.

Larvae – Live immersed in water for seven to 14 days – as few as four days.

Pupa – Live near the surface of water for two to three days.

Adult – Varies depending on species – at least one month.

Different species go through the life cycle at different rates, depending on the temperature. Some complete the cycle within a week, and some take as long as a month. The adults of some species die within a month while other species can survive through the winter and breed when the temperature turns warmer.

The mosquito life cycle includes a complete metamorphosis from egg to larva to pupa to adult. Eggs can be laid individually or in rafts and are usually laid directly on the water's surface or on a solid structure that is close to water. The eggs are whitish or yellowish when laid and will later turn brown.



Larvae that hatch from eggs must live in water and breathe air through a tube on their bodies extended above the surface of the water. Because of their constant activity in the water, they are sometimes called wigglers. Larvae are filter feeders, eating bits of algae, organic matter or each other.

The pupae, also called tumblers, are comma-shaped with large heads. They live near the surface of the water and breathe through tubes on their backs called siphons.

After a few days, the skin on the pupa splits and the adult mosquito emerges. Female adult mosquitos need blood to reproduce and are the only ones that bite.

Earthworms:

Earthworms are ready to reproduce when they are about 6 weeks old. Each worm has both male and female reproductive organs. When worms are ready to mate, two worms join together by mucus from the clitella, and sperm is passed from one worm to the other and stored in sacs. Then a cocoon forms on each clitella and the worms back out of the cocoons as they harden. Eggs and sperm are deposited in each cocoon, and the cocoon closes at both ends.

Cocoons are smaller than a grain of rice and are lemon-shaped. As the worms develop inside, the cocoon changes color from pearly white to almost yellow and then to light brown. When the worms are ready to hatch, the cocoon will be reddish in color. Cocoons can stay dormant for years if the physical conditions are not right for hatching, but, under normal conditions, it will hatch in two to three weeks. The hatchlings that emerge are whitish in color and are about 1.25 to 2.5 cm (0.5 to 1 in).

Paddlefish:

Compared to most fish, paddlefish mature late in life. Males usually reach sexual maturity in seven to nine years, and females usually mature in 10 to 12 years. Males can spawn every year after reaching sexual maturity, but females need two or more years to produce more eggs. A large female can produce approximately 1 million eggs. These eggs are not contained in an ovary, but instead are enclosed in a thin membrane within the body cavity.

Paddlefish are broadcast spawners and require specific conditions for spawning. Eggs must be laid in a body of water with a good current and water temperatures near 13°C (60°F). Females usually release their eggs and males release their milt (sperm) over a clean gravel bar or other hard substrate. When fertilization occurs, the eggs become sticky so they will adhere to the gravel bars. The current keeps the eggs oxygenated and prevents them from being covered with silt and debris.

Egg (embryo) – After fertilization, the development of the notochord can be seen in about 24 hours, bringing the embryo into the larval stage. A notochord is a longitudinal flexible rod which provides internal support and is located between the gut and nerve cord in chordate (backboned) embryos. The notochord is visible on the developing paddlefish embryo. Eggs will usually take five to seven days to hatch.



Larval fry – When hatchlings emerge from the egg, they are called fry or sac fry. The young have a yolk sac — a round sac on the belly — which supplies food. After a few days, the yolk sac is absorbed and the fry feed first on small insects and later on zooplankton. The rostrum begins growing shortly after birth and will make up approximately one-third of the fish’s total length.

Fingerlings – Fry become fingerlings when they reach about 2.5 to 5 cm (1 to 2 in) in length.

Adult – Mature adults can grow in excess of 91 kg (200 lbs) and over 2 m (7ft) in length. Paddlefish have been known to live 30+ years or longer.

Learning Objectives:

Students will:

- Observe and describe the life cycle of three different species —mosquitoes, earthworms and paddlefish.
- Identify the stages of metamorphosis.
- Compare and contrast the life cycles of mosquitoes, earthworms and paddlefish.

Procedure:

Follow mosquito life cycle

Mosquito kits can be obtained from East Baton Rouge Parish Mosquito Abatement and Rodent Control District No. 1. (See resources for ordering details.)

1. Students observe mosquito eggs using a hand lens or a microscope. Students draw the mosquito egg and write their observations in a journal.
2. Read and follow mosquito kit directions. Speed up the process of hatching the eggs by placing some of the eggs into a test tube, sealing it and placing it into your pocket for a few minutes. The heat from your body will cause the eggs to hatch more quickly. After viewing, the newly hatched larvae can be added to the container.
3. Discuss the four stages of metamorphosis in the life cycle of a mosquito. Explain that mosquitoes go through a complete metamorphosis: egg, larva, pupa and adult.
4. Once the eggs have hatched, place mosquito larvae on a deep-well slide and cover with a coverslip. Place the slide in a refrigerator for a few minutes to slow down the movement of the larvae. This will allow for easier observation.
5. Place the slide under a microscope. If equipment is available, the microscope can be connected to a TV for entire class viewing.
6. Students should draw the larvae and make observations in a journal. Using a centimeter ruler, measure the length of the larvae. Include data in the observations.
7. Repeat these procedures until mosquitoes have completed the life cycle and students have observed all stages during metamorphosis.
8. Using the data, determine the length of time for each stage of metamorphosis.

Assessment:

- Students name and draw the four stages of mosquito metamorphosis.
- Student journals may also be used for assessment.



Extension:

- Students can compare and contrast the stages of mosquito metamorphosis with the metamorphic stages of other insects.

Follow earthworm life cycle

Safety Note: Students should wash hands before and after working around worm bins.

1. Set up an earthworm bin in the classroom. There are many Web sites and books available with information on different types of bins that are easy to set up for a relatively low cost. (See resources.) Choose a bin that is right for your classroom situation.
2. Students investigate the life cycle of the earthworm using the Web site *The Adventures of Herman* (<http://www.urbanext.uiuc.edu/worms/>).
Students should use the information to complete the Earthworm Life Cycle Sequence.
3. Once the bin has been set up, students observe the worms using a hand lens. Worms can be carefully placed on a damp paper towel for viewing. A toothpick can be used as a tool to gently move and guide the worm. Students draw the earthworm and make observations in a journal. Using a centimeter ruler, students measure the length of the worm. Include data in the observations.
4. Continue to make frequent observations of the worm bin. When cocoons are found, they can be removed from the bin to hatch. Cocoons are about the size of a small grain of rice lid, which has been lined with moistened paper toweling. Cover the cocoons with more container to block light and keep in the moisture.
5. Students can make daily observations using a hand lens. The cocoons will change in color from pearly white to light brown as the baby worms develop. Before hatchlings emerge, the cocoons turn reddish in color. After the worms hatch, measure the length of each baby worm and record data in a journal. After hatching, carefully return hatchlings and cocoons to the bin.

Assessment:

- Students name and draw the steps of the earthworm life cycle in sequence.
- Student journals may also be used for assessment.



Follow paddlefish life cycle

Safety Note: Students should wash hands before and after working around paddlefish eggs and fry.

Classrooms that are involved in the Native Fish in the Classroom program are able to obtain paddlefish eggs. Teachers are trained and given the necessary equipment to hatch eggs and raise paddlefish in the classroom.

1. View the video *The Paddlefish: An American Treasure* (or another similar video containing information about the life cycle of the paddlefish). Discuss the stages in the life cycle of a paddlefish: egg (embryo to larva), fry (larval paddlefish, also called sac fry), fingerling and adult.
2. Carefully place a few paddlefish eggs and some water from the incubation jar in a container, such as a petri dish. Allow students to observe the eggs using a hand lens. Have students draw the egg and write their observations in a dated journal. Eggs can also be placed under a microscope for a short amount of time for viewing. Be careful that the eggs do not become overheated. If equipment is available, the microscope can be connected to a TV for entire class viewing. After viewing, return eggs to the incubation jar.
3. Continue to make daily observations of the paddlefish eggs. Eggs should hatch in five to seven days. As the baby paddlefish develops in the egg, movement can be detected, and students may be able to observe the fish turning “flips” inside of the egg. Have students continue to draw the changes they observe and write their observations in a journal.
4. After the eggs have hatched, carefully transfer a few fry and some water from the aquarium to a container, such as a petri dish. Smaller containers are best, as the fry are very active. Allow students to observe the fry using a hand lens. Have students draw the fry and write their observations in a journal. Fry can also be placed under a flex cam for a short amount of time for viewing.
5. Measure the length of fry by placing a centimeter ruler under the container. Measurements can be made when the fry swim over the ruler. Include data in the observations. After viewing, return fry to the aquarium.
6. Continue to make frequent observations of the fry. Record changes in the fry as they grow and develop into fingerlings.

Assessment:

- Students draw and label the stages in the paddlefish life cycle.
- Student journals may also be used for assessment.



Bringing it all together

1. After students have observed the development of mosquitoes, earthworms and paddlefish, discuss the differences and similarities in the life cycles. Students complete a Venn diagram showing the comparisons. (See resources.)
2. Students calculate the length of time from egg to adult for each species. Graph the results. Discuss possible reasons for differences in the length of time for development for each species.
3. Students calculate the length of time to grow for eggs to hatch for each species. Graph results. Discuss possible reasons for differences in the length of time.
4. Students use their journal drawings to compare and contrast the developmental differences of each species as the organisms go through each developmental stage. Discuss the following:
 - Which species changed the most, and which species changed the least in appearance?
 - Which species grew the most, and which species grew the least from egg to adult?
 - Which species most resembles the adult after hatching?

Extensions:

- Students can compare and contrast the life cycle stages of the paddlefish with other species of fish.
- Students can research and compare the life spans of each species.
- Students can research and compare the survival rate of the hatchling for each species.



TEACHER REFERENCES:

Publications

Appelhof, M. 1997. *Worms Eat My Garbage* (2nd ed.). Flower Press: Kalamazoo.
Helpful book on how to set up and maintain a worm composting system.

Camacho, C.S., L.C. Edwards and M.L. Nabors. 2002. "The Dirt on Worms," *Science & Children*, (40:42-46).
Article about a classroom's earthworm study.

Dickerson, George. 1999, *Vermicomposting*. College of Agriculture and Home Economics, New Mexico State University: guide H-164. Available at http://www.cahe.nmsu.edu/pubs/_h/h-164.pdf or http://www.cahe.nmsu.edu/pubs/_h/h-164.html.
PDF of information on setting up worm bins and bedding types.

Integrated Waste Management Board. November 5, 2003. *The Worm Guide: A Vermicomposting Guide for Teachers*. Available at <http://www.ciwmb.ca.gov/schools/Curriculum/Worms/default.htm>.
PDF files with classroom activities on how to make a worm bin and bedding types.

Mims, Steven.D., William L. Shelton, Forrest S. Wynne and Richard J. Onders. 1999. *Production of Paddlefish*. Southern Regional Aquaculture Center Publication # 437.
Good information about the production of paddlefish.

Sutherland, Donald J. and Wayne J. Crans. *Mosquitoes in Your Life*. New Jersey Agriculture Experiment Station publication # SA220-5M-86.
Available at <http://www-rci.rutgers.edu/~insects/moslif.htm>.
Life stage of three different species of mosquitoes – Anopheles, Aede and Culex.

Vaughan, R. 2000. *Mosquitoes: Their Place On the Planet*. SeaScope Aquatic Activities. Louisiana Sea Grant College Program: Baton Rouge, LA.
Mosquito unit designed for use with Scope-on-a-Rope. To order, call (225) 578-6448, or email jsche15@lsu.edu.

Internet sources

Enchanted Learning. *Mosquito Life Cycle*.
<http://www.enchantedlearning.com/subjects/insects/mosquito/lifecycle.shtml>.
Accessed July 14, 2004.
Visuals showing the life cycle of the mosquito.

Louisiana Mosquito Control Association. <http://www.lmca.us/education/education.htm>.
Accessed July 14, 2004.
Education page with activities and games using information about mosquitoes. Includes a slide show with photographs and information about the stages in the mosquito life cycle.

Schools of California Online Resources for Education. *Venn Diagram*.
<http://www.sdcoe.k12.ca.us/score/actbank/tvenn.htm>. Accessed June 14, 2004.
Describes a Venn diagram and how to use one.

Upper Midwest Environmental Sciences Center. *Paddlefish Study Project*.
<http://www.umesc.usgs.gov/aquatic/fish/paddlefish/main.html>. Accessed June 14, 2004.
Information for restoring depleted paddlefish populations. Also has a paddlefish video that can be downloaded for viewing.



Urban Programs Resource Network. *The Adventures of Herman*. <http://www.urbanext.uiuc.edu/worms/>.
Accessed June 14, 2004.
Site designed to introduce students to worms.

Mosquito kits can be obtained from:

East Baton Rouge Parish Mosquito Abatement and Rodent Control District No. 1
2829 Gen. Ben Davis Jr. Ave.
Metro Airport
Baton Rouge, LA 70807
Phone (225) 356-3297

Tracy Armand
Grolee Elementary
Opelousas, La.

Grade Level
Middle School (6-8)

Duration
Four to six weeks

Subject Area
Inquiry
Life Science

Materials List

- *Daphnia* spp.
- Computer with internet access and presentation capabilities
- BM #1-3

Grade/Benchmark/GLE Science
6,7,8/SI-M-A1/1,2
6,7,8/SI-M-A4/10-13
6,7,8/SI-M-B1/25,27
7/LS-M-D1/30
9/SI-H-A2/4

BM = Blackline Master

Pass the Water Fleas, Please



NOTE: This lesson should be used only after paddlefish have been eating food for a couple of weeks.

Focus/Overview:

Over the course of several weeks, students will be engaged in detailed observations of paddlefish during periods of feeding. They will record qualitative data of feeding behavior, physical descriptions of rostrum development, and infer the relationship between these components.

Background Information:

Paddlefish are filter feeders, having comb-like rakers that filter plankton from the water. They feed primarily on microscopic crustaceans including *Daphnia* spp., copepods and ostracods.

Daphnia spp., commonly known as water fleas, are small freshwater crustaceans. They are a major food source for young and adult freshwater fish. Copepods can be found in freshwater and saltwater. Ostracods are abundant in the marine environment and are also found in freshwater lakes and streams. Some species of ostracods are scavengers that feed on dead fish.

Additional background information on BM #1.

Learning Objectives:

Students will:

- Observe and infer sources of food for the paddlefish.
- Conduct Web searches to learn about *Daphnia* spp., copepods and ostracods as food for paddlefish.
- Create and share PowerPoint reports about one food source of paddlefish.



Procedure:

Preparation

Before starting this activity, make sure that you have a healthy *Daphnia* spp. colony. Information on how to feed and raise *Daphnia* spp. can be found in the *Native Fish Manual*.

Daphnia spp. can be purchased from several sources:

Carolina Biological, <http://www.carolina.com>

Science Stuff, <http://www.sciencestuff.com>

NASCO Science Catalog, <http://www.enasco.com/prod/Home>

WARD's Natural Science, <http://wardsci.com/Default.asp?>

Day 1

Show students a picture of an adult paddlefish, noting its large size. Ask the students what they think paddlefish feed on. Have them brainstorm ways in which they might discover what paddlefish eat. Record their ideas, and lead the discussion to include observations of eating preferences displayed by paddlefish in the recirculating tank in your classroom.

Tell students that they will be making observations of paddlefish feeding behaviors. Students split up into small groups; each group will get a chance to watch the fish feed. Students will record predictions and observations of each feeding, including information about the duration of feeding and type and number of behaviors observed. Use the feeding observation sheet (BM #2).

Some examples of feeding behaviors to look for:

- Movement: type, speed, length
- Level of fish in water column
- Interactions with other fish
- Physical description of fish

Each group of students will make five-minute observations of the behaviors of the fish without food in the tank and record their findings.

Days 2 to 7 (Time depends on number of groups.)

Each day, one group will make two five-minute observations.

The first five minutes, the groups will observe and record fish before food is introduced. Then, for the second five minutes, groups will observe the paddlefish when crumble food is introduced and record their findings. Students gather around the tank before the automatic timer releases the crumble, or one of the students will feed the fish 1/8 teaspoon of crumble by sprinkling it on the surface of the tank.



Week 2

Each day, one group will make two five-minute observations, one before feeding and one during feeding.

The groups will observe as paddlefish feed on *Daphnia* spp. Pick one student from the group to take a small fish net and dip it into the *Daphnia* spp. tank. With the *Daphnia* spp. in the net, the student then dips it into the recirculating tank to release the *Daphnia* spp. Remove the empty net and observe and record feeding behaviors.

If possible, repeat step 4, with ostracods and copepods. Then students will be able to see if there are any different feeding strategies or preferences between the different types of organisms. This would extend through the next week or two.

Week 3

Students write a paragraph summarizing their observations, findings and inferences of paddlefish feeding behavior.

Conduct a class discussion on students' observations, findings and inferences. Give students background information on the diet of paddlefish and the structure and function of their filter feeding systems (BM #1).

Divide the class into small groups and begin a Web search to learn more about paddlefish and their eating habits. Choose "expert groups" to focus on *Daphnia* spp., copepods, ostracods or other interesting food preferences or behaviors of paddlefish learned through this lesson and accompanying Web search. Students develop a PowerPoint report to show what they have learned. Provide sufficient time for researching and preparation of reports.

Week 4

Students give PowerPoint presentations to the class.

Assessment Strategies:

Students will be assessed on their observations (BM #2) paragraph and PowerPoint presentation (BM #3).



TEACHER REFERENCES:

Internet Sources

Dürbaum, Johannes and Thorsten-D. Künnemann. *Biology of Copepods: An Introduction*. Carl von Ossietzky University of Oldenburg.

<http://www.unioldenburg.de/zoomorphology/Biologyintro.html>.

Accessed January 5, 2004.

Images and descriptions of copepods.

Museum Victoria Australia. *Biology of Ostracods*. <http://www.museum.vic.gov.au/crust/ostbiol.html>.

Accessed January 5, 2004.

Information about the anatomy, ecology and distribution of ostracods with a link to the ostracod gallery of images.

Parmentier, Jan and Wim van Egmond. *Water Fleas*. Accessed January 5, 2004.

<http://www.microscopy-uk.org.uk/mag/artjun99/wflea.html>.

Images and descriptions of *Daphnia* spp.

Schumann, Kai. *Daphnia FAQ*. <http://www.ee.pdx.edu/~davidr/discus/articles/daphnia.html>.

Accessed January 5, 2004.

Comprehensive information for *Daphnia* spp. cultures.

Van Egmond, Wim. *Microscopic Fresh Water Crustaceans*. Microscopy-UK.

<http://www.microscopy-uk.org.uk/mag/wimsmall/crust.html>. Accessed January 5, 2004.

Images and descriptions of various freshwater crustaceans. Includes a labeled anatomy drawing of *Daphnia* spp.

Wilkins, Lon A. "Tuning Into Paddlefish," *Missouri Conservationist Online*. Conservation Commission of Missouri. <http://www.conservation.state.mo.us/conmag/2001/01/30.htm>.

Accessed January 5, 2004.

Information about the rostrum and feeding habits of the paddlefish.

Interview

Smith, Nicole. Louisiana State University Coastal Fisheries Institute: Baton Rouge, LA.

Email: nmille1@lsu.edu.

Thesis available at <http://etd.lsu.edu/docs/available/etd-11102004-154214/>



Blackline Master #1

Additional Background Information

Paddlefish are called filter feeders. They have comb-like gillrakers that strain plankton from the water. They swim with their mouths open wide so they can filter plankton from the water. Paddlefish feed primarily on microscopic and small crustaceans including *Daphnia* spp., copepods and ostracods.

At first, young paddlefish do not have gillrakers. They selectively feed by swallowing their food. Once fingerlings are about (5 in) in length, they will start to filter feed, but may still selectively feed up to one year or until they are 55 to 65 cm (22-26 in) in total length.

Research on paddlefish feeding behaviors shows that the fish use electroreceptors on their rostrum to find plankton swimming in the water. To find out what paddlefish feed on, scientists make observations of stomach contents.

Daphnia spp., commonly known as water fleas, are small freshwater crustaceans. They are a major food source for young and adult freshwater fish. Under a microscope, *Daphnia*'s heartbeat can be seen. *Daphnia* spp. can reproduce both sexually and asexually. Most of the time, the population consists of females that reproduce asexually. The population can increase quickly because a female may produce more than 100 eggs per brood every three days. *Daphnia* spp. feed on bacteria, yeast, micro algae, detritus and dissolved organic matter. For photographs and images of anatomy, visit <http://www.microscopy-uk.org.uk/mag/wimsmall/crust.html>.

Copepods can be found in fresh and salt water. Most of the 9,000 species of copepods crawl or swim, but at least one-third live as parasites on fish and invertebrates. Some species of copepods can be found in peat moss or in wet compost heaps. The body of the copepod is slender and segmented. Its antennae allow it to drift in the water. Males fertilize females during copulation by attaching a spermatophore to the genital field of the female. The female then forms egg sacs within a few hours to a few days after fertilization. The egg sacs are in pairs and are carried outside the body under the abdomen. They may produce several thousand eggs. Copepods feed on algae and microbes. For more information on habitat and photographs of copepods, visit <http://www.uni-oldenburg.de/zoomorphology/Biologyintro.html>.

Ostracods are abundant at sea, but some live in lakes and streams. In total, there are 8,000 different species. At sea, most are benthic, (live on the bottom) and move with their legs barely visible from between the shells of the carapace. Some species of ostracods are scavengers, feeding on dead fish. Others have strong claws for grabbing small live prey. The mating of the ostracods is unique. The males attract females using flashing lights to signal, like Morse code. The females brood eggs in a chamber of the carapace, then the males transfer sperm to the female before the eggs are laid. Ostracods can live for more than two years, but molt only four or five times during their lifetime. For more information on the habitat, anatomy and photographs of ostracods, visit <http://www.museum.vic.gov.au/crust/ostbiol.html>.



Blackline Master #2

Name _____

Feeding Observations

Physical description of fish (rostrum development)

Date	Time	Food Source	Observation Time	Behavior During Feeding	
				Type	Number of times
	11:03	crumble	5 minutes	Behavior Type	✓ ✓ ✓

Answer questions after recording all observations. Use back of page.

1. What was the most common feeding behavior?
2. Did you notice any changes in feeding behavior as the paddlefish developed?
3. How did the paddlefish act or move when feeding?
4. Where were the paddlefish in the water column when feeding?



PowerPoint Presentation Scoring Rubric

Successfully Accomplished 4	Mostly Accomplished 3	Partially Accomplished 2	Insufficient 1	No Effort 0
--------------------------------	--------------------------	-----------------------------	-------------------	----------------

Factual Information					
Information is accurate and is at an appropriate level for the audience.	4	3	2	1	0
Information is timely and is relevant to the presentation of the topic.	4	3	2	1	0
The significance of the topic is communicated to the audience	4	3	2	1	0
A list of resources is provided (Web sites, books, etc.).	4	3	2	1	0
Organization					
Presentation follows a clear, logical plan. The organization is obvious to the audience.	4	3	2	1	0
Visual aids are useful to the audience in furthering their understanding (readable, clear, logical).	4	3	2	1	0
Presentation					
Student worked well with others and shared in the actual presenting.	4	3	2	1	0
The presentation was clear and understandable to the audience.	4	3	2	1	0
Score					

Appendix II

References

Publications

- American Forest Foundation. 1996. "Tree Cookies." *Project Learning Tree, Environmental Education Activity Guide*. American Forest Foundation: Washington, D.C. pp 289-292.
- Appelhof, M. 1997. *Worms Eat My Garbage* (2nd ed.). Flower Press: Kalamazoo, Mich. Helpful book on how to set up and maintain a worm composting system.
- Aquatic Education Program* (teacher's manual). Booker Fowler Fish Hatchery, Forest Hill, La. 71430.
- Back, Cristine and Bo Jarner (photo) . 1986. *Chicken and Egg*. 1st U.S. Ed. Silver Burdett Company: Morristown, N.J. pp 11-25.
Pictures for students use to fill in the chart about chicken development.
- Barrett-O'Leary, M. 2002. *OH NO! Hannah's Swamp is Changing*. Louisiana Sea Grant College Program: Baton Rouge, La. 30 pp.
Hannah the heron experiences changes in the swamp she lives in when a non-native plant begins growing and spreading.
To order, call (225) 578-6448, or email jsche15@lsu.edu, cost \$10.00.
- Be on the Look Out...: Invasive Species on the Move in Louisiana* (brochure). 2002. Louisiana Sea Grant College Program: Baton Rouge, La.
Focuses on invasive species that threaten habitats and ecosystems. Includes photographs and a brief profile of various threatening species. To order, call (225) 578-6448, or email jsche15@lsu.edu.
- Booker Fowler Fish Hatchery Aquatic Education Program*. "Learn the Terms." Western Regional Environmental Education Council, (Project WILD), U.S. Fish and Wildlife Service Office of Endangered Species: Washington, D.C. Available from Angela Capello, Louisiana Department of Wildlife and Fisheries. To order, call (318) 748-6999, or email capelloa@centurytel.net.
- Booker Fowler Fish Hatchery Aquatic Education Program*. "Wildlife Laws and What They Mean." U.S. Fish and Wildlife Services Office of Endangered Species: Washington, D.C. Available from Angela Capello, Louisiana Department of Wildlife and Fisheries.
- Bond, Carl E. 1996. *Biology of Fishes*. Second edition. Saunders College Publishing. Harcourt Brace and Company. Orlando, Fla. pp.121-128.
Information on fish species in the subclass Chondrostei, including paddlefish, sturgeons and bichirs.
- Bryan, C. Fredrick and Allen Rutherford, editors. 1993. *Impacts on Warmwater Streams: Guidelines for Evaluation*. Southern Division, American Fisheries Society: Little Rock, Ark.
- Buttner, Joseph, Richard Soderberg and Daniel Terlizzi. 1993. *An Introduction to Water Chemistry in Freshwater Aquaculture*. Northeastern Regional Aquaculture Center, University of Massachusetts Dartmouth: North Dartmouth, Mass. Electronic edition available at http://www.ag.auburn.edu/ras/publications/water_quality/wqchemntronrac170.pdf.

- Capello, Angela. *Booker Fowler Fish Hatchery and the Story of Finnie the Fingerling*. 2000. Louisiana Department of Wildlife and Fisheries Aquatic Education Program: Baton Rouge, La.
A coloring/storybook depicting the hatchery's role in the development of specific species of fish, including the paddlefish.
- Camacho, C.S., L.C. Edwards and M.L. Nabors. 2002. "The Dirt on Worms," *Science and Children* (40:42-46).
Article about a classroom's earthworm study.
- Dickerson, George. 1999. *Vermicomposting*. College of Agriculture and Home Economics, New Mexico State University: guide H-164. Available at http://www.cahe.nmsu.edu/pubs/_h/h-164.pdf or http://www.cahe.nmsu.edu/pubs/_h/h-164.html.
PDF of information on setting up worm bins and bedding types.
- Francis-Floyd, Ruth and Craig Watson. 1990. *Ammonia*. University of Florida Cooperative Extension Service Institute of Food and Agricultural Sciences: Gainesville, Fla.
Electronic edition available at <http://www.ag.auburn.edu/ras/publications/Update/Ammonia.pdf>.
- Gugino, Sam. Nov. 30, 1999. "American Caviar: There's nothing fishy about North America's answer to this classic delicacy." *Wine Spectator*.
http://www.winespectator.com/Wine/Archives/Show_Article/0,1275,2447,00.html.
Accessed May 8, 2004.
- Haddens LA-TEX Quadrangle. U.S. Geological Survey 1954, 1969 and 1984.
- Healthy Water, Healthy People: *Testing Kit Manual*. 2002. The Watercourse: Bozeman, Mont.
Available at <http://www.healthywater.org>.
Watercourse workshop that distributes materials through training workshops and institutes as well as directly to the public.
- Healthy Water, Healthy People: Water Quality Educators Guide*. 2003. The Watercourse: Bozeman, Mont.
Available at <http://www.healthywater.org>.
A 250-page activity guide for educators of students in grades 6 through university.
- Integrated Waste Management Board. Nov. 5, 2003. [The Worm Guide: A Vermicomposting Guide for Teachers](http://www.ciwmb.ca.gov/schools/Curriculum/Worms/default.htm). Available at <http://www.ciwmb.ca.gov/schools/Curriculum/Worms/default.htm>.
PDF files with classroom activities on how to make a worm bin and bedding types.
- Louisiana Department of Education. 2004. Grade Level Expectations (GLE) Handbook: Grades Pre-Kindergarten to 12. Baton Rouge: Louisiana Department of Education.
Available at <http://www.doe.state.la.us/lde/ssa/1819.html>
- Mims, Steven .D., William L. Shelton, Forrest S. Wynne and Richard J. Onders. 1999. *Production of Paddlefish*. Southern Regional Aquaculture Center Publication No. 437.
Good information about the production of paddlefish.
- Mississippi Interstate Cooperative Resource Association Paddlefish/Sturgeon Committee. 2003. Draft: *Paddlefish Strategic Plan 2003-2008*.

- Neiman, Alexander et al. "Stochastic Synchronization of Electroreceptors in the Paddlefish." University of Missouri: St. Louis, Mo.
<http://neurodyn.umsi.edu/~neiman/synchronization/>. Accessed June 11, 2004.
 This scientific article may be a little difficult to understand, but contains great close-up images of the electroreceptors, *Daphnia* spp., and a movie clip showing a paddlefish feeding on brine shrimp.
- Nonindigenous Species Activities for Youth*. Mississippi State University Extension Service publication No. 2286. 78 pp.
 Activities geared to help students understand what exotics are and the impact they have on an area. Profiles of selected species are also provided.
- Owen, Oliver S. 1994. *Tadpole to Frog*. Abdo Consulting Group, Inc. Minneapolis, Minn. pp 22, 24.
 Information relating to variations in frog reproduction. Many photographs, including tadpole pictures.
- Parr, Dudley. Jan./February 1999. "Progress with Paddlefish Restoration." *Pennsylvania Angler and Boater*.
<http://sites.state.pa.us/Fish/anglerboater/1999/jf99/padlfish.htm>.
 Accessed June 11, 2004.
 Article on paddlefish includes information on growth rates.
- Reed, Bobby C., W.E. Kelso and D.A. Rutherford. 1992. "Growth, Fecundity, and Mortality of Paddlefish in Louisiana." *Transactions of the American Fisheries Society*. 121:378-384.
 A comprehensive study of paddlefish in Louisiana.
- Richardson, Carl. Jan./February 2003. "Paddlefish: Restoring a Legacy." *Pennsylvania Angler and Boater*.
http://sites.state.pa.us/PA_Exec/Fish_Boat/anglerboater/2003/jf03angler/paddlefish.pdf.
 Accessed June 11, 2004.
 General paddlefish information and information on efforts in Pennsylvania to restore the extirpated population.
- Soniat, L. 1996. Project TELLUS Teaching Modules for Global Change Issues: Exotic Species. Louisiana Sea Grant College Program: Baton Rouge, LA.
- Springer, Craig. Dec. 5, 2000. "And You Thought It was a Freshwater Shark." *Environmental News Network*.
http://www.enn.com/features/2000/12/12052000/paddlefish_12806.asp.
 Accessed June 14, 2004.
 Focuses on the role of hatcheries to restore paddlefish populations. Includes general facts on the fish.
- Sutherland, Donald J. and Wayne J. Crans. Mosquitoes in Your Life. New Jersey Agriculture Experiment Station publication No. SA220-5M-86. Available at
<http://www-rci.rutgers.edu/~insects/moslife.htm>.
 Life stage of three different species of mosquitoes – *Anopheles*, *Aede* and *Culex*.
- Understanding Invasive Aquatic Weeds*. Aquatic Plant Management Society Inc. 15pp. Vicksburg, Miss. 2002.
 Activity book to increase awareness of the importance of native plants in lakes, rivers and wetlands, and the destructive potential of invasive weeds to these areas.

- Vaughan, R. 2000. *Mosquitoes: Their Place On the Planet*. SeaScope Aquatic Activities. Louisiana Sea Grant College Program: Baton Rouge, La. Mosquito unit designed for use with Scope-on-a-Rope. To order, call (225) 578-6448, or email jsche15@lsu.edu.
- Wagner, Steve. March/April 1992. "The Prehistoric Paddlefish." *Outdoor Oklahoma*. http://www.nativefish.org/Articles/Pre_Paddlefish.htm. Accessed June 14, 2004.
- Washington State Joint Natural Resources Cabinet. 1999. *Statewide Strategy to Recover Salmon – Extinction is Not an Option, Hatchery Management to Meet the Needs of Wild Fish*. Olympia, Wash. Electronic edition available at <http://www.governor.wa.gov/gspro/strategy/strategy/hatcheries.pdf>. Hatcheries information from the Web site of Governor Gary Locke of Washington.
- Wetland and Invasive Plants of the Southeast*. University of Florida Center for Aquatic and Invasive Plants. University of Florida publication No. SP276. 37pp. Coloring book includes drawings of 59 native wetland plants of the southeastern United States.
- White, William, Jr. 1972. *A Frog is Born*. Sterling Publishing Co.: New York, N.Y. pp 29-37. Excellent source on frog embryology. Both the text and the pictures will be useful to students in filling in their charts.
- Williamson, D.F. 2003. *Caviar and Conservation: Status, Management and Trade of North American Sturgeon and Paddlefish*. TRAFFIC North America: Washington, D.C. Electronic edition available at <http://www.traffic.org>.
- Zim, Herbert S. and Joy Buba. 1950. *Frogs and Toads*. William Morrow and Co.: New York, N.Y. Drawings rather than photographs, but the text is especially useful to students.

Multimedia

- DWP Inc. *Into the Outdoors*. Milwaukee, Wis. http://www.intotheoutdoors.org/ito_sg_307_paddlefish.html. Accessed May 20, 2004. Information on paddlefish and a short streaming video on paddlefish monitoring in Wisconsin narrated by a middle-school girl.
- Louisiana Public Broadcasting Television Network. *Enviro-Tacklebox Module No. 3: Non-Native Invasion* (video). 2000. Ordering information at <http://www.envirotacklebox.org>.
- Wills, Betty. *The Paddlefish: An American Treasure* (video). Earthwave Society: Fort Worth, Texas. This video addresses all facets of the life of paddlefish in the United States. It includes information on ongoing conservation efforts and methods, as well as the reasons for the decline of the population and current laws. Summary and ordering information at <http://www.earthwave.org/paddlefish.htm>. Cost \$24.95 plus shipping and handling.

Internet sources

- American Fisheries Society. *Listing of Abstracts on Paddlefish Biology and Management from the 1998 Southern Division of the American Fisheries Society*. <http://www.sdafs.org/meetings/98sdafs/reservoir/reservoir.htm>. Accessed June 11, 2004.

- American caviar – *Paddlefish caviar*. 1-800-caviar.com.
<http://www.1-800-caviar.com/paddle-fish.html>. Accessed July 22, 2003.
Commercial site that sells paddlefish roe, includes pricing and description of the taste of paddlefish roe.
- “An American Journey.” *Jackson Times*.
<http://www.pasorobles-usa.com/paddlefish.htm>. Accessed Jan. 21, 2004.
Article describes the journey of a tagged paddlefish that crossed dams.
- Aswan High Dam. <http://teacherlink.ed.usu.edu/tlresources/units/byrnes-africa/KAYMUR/>.
Accessed Jan. 21, 2004.
Lesson plan with additional background information.
- The Bridge, Ocean Sciences Education Teacher Resources. *Exotic Species*.
<http://www.vims.edu/bridge/exotic.html>. Accessed June 14, 2004.
Numerous links to exotic species sites.
- Cebra-Thomas, Judy. *Overview of Chick Development*. Swarthmore College.
http://www.swarthmore.edu/NatSci/sgilber1/DB_lab/Chick/Chick_dev.html.
Accessed July 20, 2003.
College-level description of chick embryology, reference for teachers, although the site does include some images that might be helpful to students.
- Commonwealth of Pennsylvania, Fish and Boat Commission. *Question of the Week*.
http://sites.state.pa.us/PA_Exec/Fish_Boat/qpadl.htm. Accessed July 22, 2003.
Paddlefish restoration in Pennsylvania.
- Cooper, Calene. *Missouri State Aquatic Animal – Paddlefish Model Assembly*. Successlink.
<http://www.successlink.org/great2/g661.html>. Accessed June 14, 2004.
Lesson plan using model, background information on paddlefish and links to other paddlefish sites.
- Corsentino, Pattyanne. 1995. *Ecosystem Matters: Activity and Resource Guide for Environmental Educators*. U.S. Department of Agriculture.
<http://www.na.fs.fed.us/spfo/pubs/misc/eco/>. Accessed June 14, 2003.
- Decelles, Paul. *pH Scale*. The Entangled Bank.
<http://staff.jccc.net/pdecell/chemistry/phscale.html>. Accessed June 14, 2004.
Full-color scale with examples of solutions at each pH level.
- Delaware Sea Grant Marine Advisory Service. *Delaware Aquaculture Resource Center Home Page*. <http://128.175.24.162>. Accessed June 11, 2004.
An archive of information about aquaculture in Delaware and the Mid-Atlantic region, covering both freshwater and marine culture. Maintained and continually updated by the Sea Grant Marine Advisory Service Aquaculture Specialist to provide an expanding list of resources and other useful information.
- Department of Justice. Jan. 31, 2002. *Caviar Company and President Convicted in Smuggling Conspiracy*. http://www.usdoj.gov/opa/pr/2002/Jan./02_enrd_052.htm.
Accessed May 7, 2004.

- DeVries, Dennis. *Restoration of the Paddlefish in Alabama*. Auburn University Department of Fisheries and Allied Aquaculture and Alabama Department of Conservation and Natural Resources, Division of Wildlife and Freshwater Fisheries.
<http://www.ag.auburn.edu/fisheries/peak/paddlefish/>. Accessed July 22, 2003.
Describes Alabama paddlefish studies.
- Dillard, Jack, Dennis McIntosh and Chad King. *Aquaculture in the Classroom*. Distributed Learning Committee of the College of Agriculture and Life Sciences, University of Arizona. <http://ag.arizona.edu/azaqua/extension/Classroom/home.htm>.
Accessed June 11, 2004.
Information on aquaculture in Arizona, starting an aquaculture system, water quality maintenance, aquaponics and more.
- Division of Fisheries U.S. Fish and Wildlife Southwest Region. *Facts About Fish in the Southwest – paddlefish*. <http://southwest.fws.gov/fishery/species/paddlefish.htm>.
Accessed June 11, 2004.
Includes paddlefish biology and describes legal catch of paddlefish in Iowa.
- Dürbaum, Johannes and Thorsten-D. Künnemann. *Biology of Copepods: An Introduction*. Carl von Ossietzky University of Oldenburg.
<http://www.unioldenburg.de/zoomorphology/Biologyintro.html>. Accessed Jan. 5, 2004.
Images and descriptions of copepods.
- Enchanted Learning. *Mosquito Life Cycle*.
<http://www.enchantedlearning.com/subjects/insects/mosquito/lifecycle.shtml>.
Accessed July 14, 2004.
Visuals showing the life cycle of the mosquito.
- ESPN Outdoors News Service. 2001. *Paddlefish Pounds Pavement to Kentucky*.
<http://proxy.espn.go.com/outdoors/fishing/news/2001/0808/1236866.html>.
Accessed Jan. 21, 2004.
- Fish Doc. *Fish Health and pH- Acidity and Alkalinity Explained*.
<http://www.fishdoc.co.uk/water/pH.htm>. Accessed June 14, 2004.
Information on how pH levels can affect fish health and suggestions on how to change pH levels.
- Food and Drug Administration. Aug. 22, 2002. *Warning Letter No. 02-NSV-37*.
http://www.fda.gov/foi/warning_letters/g3473d.htm. Accessed May 8, 2004.
- Gallon, Paula. *March 2002 and Frog Spawn Watch*. eRodent.
<http://www.erodent.co.uk/GardenPond/March2002.htm>. Accessed July 20, 2004.
This site has excellent pictures and may be used for one of the study stations.
Author has given permission to use the pictures.
- Gallon, Paula. *March 2002 and Frog Spawn Watch*. eRodent.
<http://www.erodent.co.uk/GardenPond/Frogspawn.zip>. Accessed June 14, 2004.
This zip file provides a better quality version of the pictures to be used for one of the study stations. Author has given permission to use the pictures.
- Grissino-Mayer, Henri D. *Ultimate Tree Ring Web Pages*. Department of Geography, University of Tennessee. <http://web.utk.edu/~grissino>. Accessed June 11, 2004.
This Web site has multiple links and many levels of information, pictures and printable lessons on annular tree rings.

- Hatch, Jay and Nicole Paulson. *All About Paddlefish*. Minnesota Pollution Control Agency. <http://www.pca.state.mn.us/kids/fish/paddlefish.html>. Accessed July 22, 2003.
Designed for kids. Paddlefish biology and distribution in Minnesota.
- Helfrich, Lou. *The Virtual Aquarium*. Virginian Polytechnic Institute and State University. <http://www.cnr.vt.edu/efish/families/polyodontidae.html>.
Accessed July 20, 2003.
Excellent pictures and an outline of paddlefish biology and discussion of the threats to the paddlefish.
- Higginbotham, Billy. *Wildlife Endangered Species: Paddlefish distribution*. Texas Agricultural Extension Service. <http://texas-extension.tamu.edu/agcom/multimed/wildlife/endanger/paddle2.html>.
Accessed June 11, 2004.
Map of main and possible paddlefish distribution in the United States.
- Illinois-Indiana Sea Grant College Program. *Exotic Aquatics on the Move*. <http://www.iisgcp.org/EXOTICSP/ans.htm#what>. Accessed June 11, 2004.
Information on nonindigenous species, impacts, examples of species and educational materials.
- Iowa Department of Natural Resources. *Fishes of Iowa*. <http://www.iowadnr.com/fish/iafish/pad-card.html>. Accessed June 15, 2004.
Includes paddlefish biology and describes legal catch of paddlefish in Iowa.
- Jackson, Donald C. and Gerd Marmulla. *The Influence Of Dams On River Fisheries*. <http://www.fao.org/DOCREP/004/Y2785E/y2785e02a.htm>. Accessed Jan. 21, 2004.
- Jones, David. *The Frog and Pond Diary – March 2002*. My Bit of the Planet. <http://www.mybitoftheplanet.com/2002/frogmarch.html#latest>. Accessed July 20, 2004.
Detailed photographs of tadpoles.
- Koncilya, Linda. *Paddlefish!* Glendive Chamber of Commerce. <http://www.midrivers.com/~chamber/pfish.htm>. Accessed July 22, 2003.
How to catch and cook Montana paddlefish, as well as information about the paddlefish.
- Louisiana Department of Wildlife and Fisheries. *Fishing Regulations 2002*. <http://www.wlf.state.la.us/apps/netgear/page1.asp>. Accessed July 22, 2003.
Status of paddlefish protection in Louisiana.
- Louisiana Mosquito Control Association. <http://www.lmca.us/education/education.htm>.
Accessed July 14, 2004.
Education page with activities and games using information about mosquitoes.
Includes a slide show with photographs and information about the stages in the mosquito life cycle.
- Louisiana Sea Grant College Program. *LaMER: Louisiana Marine Education Resources Gateways to Aquatic Science*. <http://lamer.lsu.edu/>. Accessed June 14, 2004.
Aquatic education projects, classroom resources and aquatic links.
- Louisiana State University School of the Coast and Environment. *Coastal Fisheries Institute Age and Growth Laboratory*. <http://www.cfi.lsu.edu/lifehistory>.
Accessed July 23, 2003.
Images of otoliths.

- Maryland Sea Grant Extension. *Aquaculture in Action*.
<http://www.mdsg.umd.edu/Education/AinA>. Accessed June 10, 2004.
A partnership between Maryland Sea Grant and Carroll County Public Schools is creating a network of aquaculture educators in Maryland using aquaculture as a tool for teaching science.
- MICRA – Mississippi Interstate Cooperative Resource Association. *Inter-jurisdictional Rivers of the Mississippi River Basin*. <http://www.aux.cerc.cr.usgs.gov/MICRA>. Accessed June 11, 2004.
Information on the organization, goals and membership.
- Mims, Steve. *Paddlefish Polyculture*. Kentucky State University Aquaculture Program.
<http://www.ksuquaculture.org/index.htm>. Accessed July 22, 2003.
Aquaculture of paddlefish with catfish. Includes a video on paddlefish feeding.
- Minnesota Department of Natural Resources. *Element Occurrence Records of Paddlefish*.
<http://www.nativefish.org/Articles/PaddleFigures.htm>. Accessed July 31, 2004.
Maps of occurrence of paddlefish with observations dated 1899 to 1995.
Includes indications of dams and other structures.
- Missouri River Adopt-A-Fish. *Ask A Biologist*.
<http://www.walleyesunlimited.com/adopt-fish/askbiologist.html>. Accessed Jan. 21, 2004.
Describes effects of dams on paddlefish.
- MIT Sea Grant Center for Coastal Resources. *What are Marine Bioinvaders?*
<http://massbay.mit.edu/exoticspecies/index.html>. Accessed June 11, 2004.
Definitions of marine bioinvaders, impacts on environment and ecosystem, and how exotic species arrive.
- Montana River Action. Paddlefish. <http://www.montanariveraction.org/paddlefish.html>. Accessed July 22, 2003.
Information on Montana fishing and roe, along with concerns for overfishing.
- Museum Victoria Australia. *Biology of Ostracods*.
<http://www.museum.vic.gov.au/crust/ostbiol.html>. Accessed Jan. 5, 2004.
Information about the anatomy, ecology and distribution of ostracods with a link to the ostracod gallery of images.
- National Aquatic Nuisance Species (ANS) Task Force. *Aquatic Nuisance Species*.
<http://www.anstaskforce.gov/species.htm>. Accessed June 14, 2004.
This site has profiles of selected aquatic nuisance species.
- National Council for Agricultural Education. *How-To Manuals for Aquaculture – Using Re-circulating Aquaculture Systems for Educational Purposes*.
<http://www.agedhq.org/aquaculture/howto.htm>. Accessed June 11, 2004.
- National Invasive Species Council. *Invasivespecies.gov*.
<http://www.invasivespecies.gov>. Accessed June 11, 2004.
Profiles terrestrial plants and animals, aquatic plants and animals and microbes.
- National Sea Grant College Program and the Great Lakes Sea Grant Network.
Sea Grant Nonindigenous Species Site (SGNIS). <http://sgnis.org>. Accessed June 14, 2004.
Research publications and educational materials on aquatic nuisance species, including links to other related sites.

Northern Prairie Wildlife Resource Center. *North Dakota's Federally Listed Endangered, Threatened, and Candidate Species – 1995 – Paddlefish*.
<http://www.npwr.usgs.gov/resource/distr/others/nddanger/SPECIES/POLYSPAT.HTM>.
Accessed June 11, 2004.
Status of the paddlefish in North Dakota as well physical descriptions, habitat, life history, aid to identification and reasons for decline.

Paddlefish. Iowa Department of Natural Resources.
<http://www.iowadnr.com/education/files/pddlfs.pdf>. Accessed Jan. 21, 2004.

Paddlefish Project Overview. U.S. Geological Survey Upper Midwest Environmental Sciences Center. <http://www.umesc.usgs.gov/aquatic/fish/paddlefish/video.html>.
Accessed Jan. 21, 2004.
Six-minute comprehensive video overview of the USGS Paddlefish Project, including the impact of dam construction.

Parmentier, Jan and Wim van Egmond. *Water Fleas*.
<http://www.microscopy-uk.org.uk/mag/artjun99/wflea.html>. Accessed Jan. 5, 2004.
Images and descriptions of *Daphnia* spp.

Paulson, Nicole and Jay Hatch. *Paddlefish*, *Polyodon spathula*. Minnesota Department of Natural Resources and U.S. Fish and Wildlife Service.
<http://www.gen.umn.edu/research/fish/fishes/paddlefish.html>. Accessed June 14, 2004.
Discusses the fishes of Minnesota. The site was designed for educational purposes and includes pictures, biology and reasons for paddlefish decline.

Quarry Commando.com. *Paddlefish Facts*. <http://www.quarrycommando.com/paddlefish.html>.
Accessed July 22, 2003.
Overview of paddlefish range, adaptations and life cycle. Includes many pictures.

Rader's Chem4Kids. *Acids and Bases Are Everywhere*.
http://www.chem4kids.com/files/react_acidbase.html. Accessed June 14, 2004.
Site is designed for students. Explains pH scale and includes basic chemistry definitions.

Sabine Parish Office. *Toledo Bend Dam and Reservoir*.
<http://www.sabineparish.com/attract/toledo.asp>. Accessed Sept. 10, 2004.
Information about the reservoir, hydroelectric generators and cost of construction, plus a graphic of the generator.

Sabine River Authority of Texas. *Toledo Bend Project*.
<http://www.sra.dst.tx.us/projects/tbp.asp>. Accessed Sept. 10, 2004.
History of construction, the dedication and current weather conditions.

Scarnecchia, Denis L. and Brad Schmitz. *Paddlefish*. Montana Department of Fish, Wildlife and Parks. <http://www.fisheries.org/AFSmontana/SSCpages/Paddlefish.htm>.
Accessed July 22, 2003

Schmidt, Konrad. *The Distribution and Status of Paddlefish (Polyodon spathula) in Minnesota*. Minnesota Department of Natural Resources.
<http://www.nativefish.org/Articles/PaddlefishDistribution.htm>. Accessed July 31, 2004.
This site accompanies the elemental occurrence maps from the Schmidt link.

- Schools of California Online Resources for Education. *Venn Diagram*.
<http://www.sdcoe.k12.ca.us/score/actbank/tvenn.htm>. Accessed June 14, 2004.
Describes a Venn diagram and how to use one.
- Schumann, Kai. *Daphnia FAQ*.
<http://www.ee.pdx.edu/~davidr/discus/articles/daphnia.html>. Accessed Jan. 5, 2004.
Comprehensive information for *Daphnia* spp. cultures.
- Science Junction. *Water What-ifs: Water Quality and pH*.
<http://www.ncsu.edu/sciencejunction/depot/experiments/water/lessons/pH/>
Accessed July 14, 2004.
Background information about pH.
- Science Museum of Minnesota. *April 2001 Object of the Month: Paddlefish*.
<http://www.smm.org/explorescience/onlineactivities/ootm/2001-04.php>.
Accessed June 14, 2004.
Image of skeletal rostrum and information on the paddlefish.
- Sim Science. *Cracking Dams*. <http://simscience.org/cracks/index.html>.
Accessed July 31, 2004.
Introduction to civil engineering and the construction of dams.
- Species at Risk. Canadian Wildlife Service-Environment Canada.
http://www.speciesatrisk.gc.ca/search/speciesDetails_e.cfm?SpeciesID=63.
Accessed July 23, 2003.
Paddlefish information site. Includes biology, habitat and photos.
- Species at Risk. *Paddlefish*. <http://www.speciesatrisk.gc.ca>. Accessed July 22, 2003.
Lists all known species that are designated at risk or endangered in North America and Canada. Specific threats to habitat are listed.
- Springer, Craig L. *National Fish Hatcheries Improve Paddlefish Populations*. Native Fish Conservancy. <http://www.nativefish.org/Articles/Paddlfis.htm>. Accessed June 11, 2004.
- Springer, Craig L. *Paddlefish Make a Comeback in Oklahoma*. Native Fish Conservancy. <http://www.nativefish.org/Articles/spoonbill.htm>. Accessed July 22, 2003.
Discusses paddlefish restoration efforts in Oklahoma.
- Stone, Clifton. *Paddlefish*. South Dakota Department of Game, Fish and Parks, Division of Wildlife. <http://lupus.northern.edu:90/natsource/ENDANG1/Paddle1.htm>.
Accessed June 11, 2004.
An overview of the paddlefish, its significance and conservation measures.
- Tennessee Aquarium and the IMAX 3-D Theater. *Amazing Animals – Fish: Paddlefish*.
<http://www.tnaqua.org/Animals/Fish.asp#>. Accessed June 15, 2004.
Pictures, reasons that paddlefish are threatened and brief descriptions of paddlefish biology.
- Texas Extension. *Wildlife Distribution*.
<http://texas-extension.tamu.edu/agcom/multimed/wildlife/endanger/paddle2.html>.
Accessed July 31, 2004.
Map of main and possible paddlefish distribution in the United States.

- Texas Parks and Wildlife. *Listening Library Table of Contents*.
<http://www.passporttotexas.com/audiolib/fishlib.htm>. Accessed June 11, 2004.
Listing of articles and information on paddlefish.
- Texas Parks and Wildlife. *Texas Freshwater Fishing: Paddlefish*.
<http://www.tpwd.state.tx.us/fish/infish/species/pad/pad.htm>. Accessed Jan. 21, 2004.
Biology of paddlefish life cycle, habitat and threats to paddlefish in Texas.
- Toledo Bend Lake, Dam and Generating Station.
http://www.toledo-bend.com/toledo_bend/index.asp?request=tolbenddam.
Accessed Sept. 10, 2004.
Facts about the dam and power plant.
- Trade and Environment Database. *Caviar Trade Case No. 221*.
<http://www.american.edu/TED/caviar.htm>. Accessed May 7, 2004.
- Truman Info Guide. *Spoonbill – (Paddlefish=Polyodon spathula)*.
<http://www.trumaninfo guide.com/GeneralDoc/paddleFish.cfm>. Accessed June 15, 2004.
Distribution of paddlefish in Missouri and fishing for paddlefish in Missouri.
- UNEP-WCMC. *CITES-Listed Species*.
<http://sea.unep-wcmc.org/isdb/CITES/Taxonomy/tax-species-result.cfm?displaylanguage=engandGenus=PolyodonandSpecies=spathulaandsource=animalsandCountry=US>.
Accessed April 21, 2004.
Description of paddlefish status world wide.
- Upper Midwest Environmental Sciences Center. *Paddlefish Study Project*.
<http://www.umesc.usgs.gov/aquatic/fish/paddlefish/main.html>. Accessed June 14, 2004.
Information for restoring depleted paddlefish populations. Also has a paddlefish video that can be downloaded. Contains an animated map of the distribution of paddlefish.
- Urban Programs Resource Network. *The Adventures of Herman*.
<http://www.urbanext.uiuc.edu/worms/>. Accessed June 14, 2004.
Site designed to introduce students to worms.
- U.S. Fish and Wildlife Service. *Natchitoches National Fish Hatchery*.
<http://natchitoches.fws.gov/WHAT.HTML>. Accessed June 11, 2004.
Describes hatchery propagation of paddlefish and other fish. Photographs of hatching jars and paddlefish and information about visiting the hatchery.
- U.S. Fish and Wildlife Service Region 3 Fisheries Great Lakes. *Paddlefish Conservation in the Mighty Mississippi River Basin*.
<http://midwest.fws.gov/Fisheries/topic-paddlefish.htm>. Accessed June 11, 2004.
Information, brochure and video clips of paddlefish in the upper Mississippi River basin.
- U.S. Geological Survey Upper Midwest Environmental Sciences Center. *Frequently Asked Questions*. <http://www.umesc.usgs.gov/aquatic/fish/paddlefish/faq.html>.
Accessed Jan. 21, 2004.
Map of the present distribution of paddlefish in the United States and the effect of river modifications.

U.S. Geological Survey. *USGS Nonindigenous Aquatic Species*.
<http://nas.er.usgs.gov/>. Accessed June 11, 2004.
Information on aquatic vertebrates, invertebrates and plants.

Van Egmund, Wim. *Microscopic Freshwater Crustaceans*. Microscopy-UK.
<http://www.microscopy-uk.org.uk/mag/wimsmall/crust.html>. Accessed Jan. 5, 2004.
Images and descriptions of various freshwater crustaceans. Includes a labeled anatomy drawing of *Daphnia* spp.

Wilkins, Lon A. "Tuning Into Paddlefish," *Missouri Conservationist Online*. Conservation Commission of Missouri. <http://www.conservation.state.mo.us/conmag/2001/01/30.htm>.
Accessed Jan. 5, 2004.
Information about the rostrum and feeding habits of paddlefish.

Wisconsin Department of Natural Resources. *Alien Invaders, "EEK! Environmental Education for Kids."*
<http://www.dnr.state.wi.us/org/caer/ce/eeek/earth/aliens.htm>.
Accessed June 4, 2004.
Environment and environmental issues – spotlights alien species in Wisconsin.

Interview

Miller, Nicole. Louisiana State University Coastal Fisheries Institute:
Baton Rouge, La. Email: nmille1@lsu.edu.
Thesis available at <http://etd.lsu.edu/docs/available/etd-11102004-154214/>

Miscellaneous resources

Capello, Angela
Wildlife Educator III
Louisiana Department of Wildlife and Fisheries
Booker Fowler Fish Hatchery
10 Joan Stokes Road
Forest Hill, LA 71430
Phone: 318-748-6999
capelloa@centurytel.net

Reed, Bobby. "Life History and Management of Paddlefish (*Polyodon spathula*) in Louisiana." PowerPoint presentation. Presented July 7, 2003 and revised July 2004. Inland Fish Division Louisiana Department of Wildlife and Fisheries. For a copy, contact Angela Capello, capelloa@centurytel.net, or Rachel Somers, rsomer1@lsu.edu.

Walz, Gari. Bio-quest Frog Development Study Kit Teacher's Guide. 1996.
Nasco: Fort Atkinson, Wisconsin. Can be obtained from Fisher Scientific, p.183, 2003-2004 catalog, \$78.00 Catalog No. AJS11011.
The teacher's guide and a student's guide come with the plastic mounted Frog Development Study Kit. It is an excellent teacher reference, but may be too advanced for middle school students.

Appendix III

Louisiana Learning Standards and Grade Level Expectations Matrix for Lesson Plans and Definitions of Louisiana Learning Standards

	<i>Lesson Name</i>	<i>Comparing Eggs & Embryos</i>	<i>Snagging Paddlefish Data</i>	<i>My Fish Ride a Nitrogen Cycle</i>	<i>What a Nuisance!</i>	<i>Do You Believe in pH Magic?</i>	<i>Life Cycles of the Wet and Wiggly</i>	<i>Extirpated? Don't You Mean Extinct?</i>	<i>How Fast Do Paddlefish Grow?</i>	<i>How Old is That Fish?</i>	<i>Do Dams Affect the Paddlefish Population?</i>	<i>Critical Conditions for Paddlefish Spawning</i>	<i>Pass the Water Fleas, Please</i>
Science as Inquiry													
SI-M-A1		X	X				X						X
GLE 5,6,7,8/No.		3	3				3						1,2
SI-M-A2			X		X								
GLE 6,7,8/No.			4		4								
SI-M-A3	X			X	X		X	X	X				
GLE 6,7,8/No.	6,7			7	7,8		6-8	7	7				
SI-M-A4					X	X	X			X	X		
GLE 6,7,8/No.					10,12,13	11	11-13			12,13	10-13		
SI-M-A5				X			X	X	X				
GLE 6,7,8/No.				14-16			16	16	14,16				
SI-M-A7			X								X		
GLE 6,7,8/No.			19								19,22		
SI-M-A8				X									
GLE 6,7,8/No.				23									
SI-M-B1													X
GLE 6,7,8/No.													25,27
SI-M-B2					X								
GLE 6,7,8/No.					28								
SI-M-B3								X					
GLE 6,7,8/No.								31					
SI-H-A2							X						X
GLE HS/No.							4						4
SI-H-A4					X								
GLE HS/No.					7								
Science & Environment													
SE-M-A3							X						
SE-M-A4			X				X		X	X			
GLE 7/No.			39				39		39	39			
SE-M-A5							X						
SE-M-A7		X			X								
GLE 7/No.		41											
SE-H-A6			X										
GLE HS/No.			7										

Louisiana Learning Standards and Grade-Level Expectations Matrix for Lesson Plans

	<i>Lesson Name</i>	<i>Comparing Eggs & Embryos</i>	<i>Snagging Paddlefish Data</i>	<i>My Fish Ride a Nitrogen Cycle</i>	<i>What a Nuisance!</i>	<i>Do You Believe in pH Magic?</i>	<i>Life Cycles of the Wet and Wiggly</i>	<i>Extirpated? Don't You Wiggly</i>	<i>How Fast Do Paddlefish Grow?</i>	<i>How Old is That Fish?</i>	<i>Do Dams Affect the Paddlefish Population?</i>	<i>Critical Conditions for Paddlefish Spawning</i>	<i>Pass the Water Fleas, Please</i>
Life Science													
LS-M-A3	X					X							
GLE 7/No.	6					5,6							
LS-M-C3				X									
LS-M-C4				X						X			
GLE 7/No.				29									
LS-M-D1				X								X	
GLE 7/No.				31								30	
LS-M-D2				X					X				
GLE 7/No.				32,33					32				
LS-H-C1	X												
GLE 10/No.	15												
LS-H-C6						X							
LS-H-D3											X		
GLE 10/No.											26		
LS-H-D4											X		
GLE 10/No.											27		
LS-H-F3											X		
GLE 10/No.											35		
Physical Science													
PS-M-A3					X								
PS-H-A1					X		X						
GLE HS/No.					2		2						
PS-H-D2					X								
GLE HS/No.					23,33								
Earth & Space Science													
ESS-H-B1			X										
GLE 10/No.			13										

Louisiana Learning Standards and Grade-Level Expectations Matrix for Lesson Plans

	<i>Lesson Name</i>	<i>Comparing Eggs & Embryos</i>	<i>Snagging Paddlefish Data</i>	<i>My Fish Ride a Nitrogen Cycle</i>	<i>What a Nuisance!</i>	<i>Do You Believe in pH Magic?</i>	<i>Life Cycles of the Wet and Wiggly</i>	<i>Extirpated? Don't You Mean Extinct?</i>	<i>How Fast Do Paddlefish Grow?</i>	<i>How Old is That Fish?</i>	<i>Do Dams Affect the Paddlefish Population?</i>	<i>Critical Conditions for Paddlefish Spawning</i>	<i>Pass the Water Fleas, Please</i>
Mathematics													
M-1-M								X					
GLE 6/No.								18					
M-6-M								X					
D-1-M								X					
GLE 8/No.								34,35					
D-2-M								X					
GLE 6/No.								30					
GLE 7/No.								33					
GLE 8/No.								41					
D-1-H								X					
GLE 11,12/No.								17					
D-7-H								X					
GLE 9/No.								28					
GLE 10/No.								22					
Social Studies													
G-1D-M1										X			
GLE 8/No.										14			
Language Arts													
ELA-1-M1							X						
GLE 6/No.							1,3						
GLE 7,8/No.							1						
ELA-1-M3				X			X						
GLE 6/No.				6			6						
GLE 7,8/No.				4			4						
ELA-1-M4				X									
GLE 6/No.				7									
GLE 7,8/No.				5									
ELA-1-H3				X			X						
GLE 9-12/No.				4			4						
ELA-1-H4				X									
GLE 9-12/No.				5									
Creative Arts													
VA-CE-M2				X									
VA-CE-M3				X									

From: Louisiana Department of Education. 2004. Grade-Level Expectations Handbook.

Science as Inquiry

SI-M-A1 *Identifying questions that can be used to design a scientific investigation*

GLE 6-8/No.

1. Generate testable questions about objects, organisms and events that can be answered through scientific investigations.
2. Identify problems, factors and questions that must be considered in a scientific investigation.
3. Use a variety of sources to answer questions.

SI-M-A2 *Designing and conducting a scientific investigation*

GLE 6-8/No.

4. Design, predict outcomes and conduct experiments to answer guided questions.

SI-M-A3 *Using mathematics and appropriate tools and techniques to gather, analyze and interpret data*

GLE 6-8/No.

6. Select and use appropriate equipment, technology, tools and metric system units of measurement to make observations.
7. Record observations using methods that complement investigations (e.g. journals, tables, charts).
8. Use consistency and precision in data collection, analysis and reporting.

SI-M-A4 *Developing descriptions, explanations and graphs using data*

GLE 6-8/No.

10. Identify the difference between description and explanation.
11. Construct, use and interpret appropriate graphical representations to collect, record and report data (e.g., tables, charts, circle graphs, bar and line graphs, diagrams, scatter plots, symbols).
12. Use data and information gathered to develop an explanation of experimental results.
13. Identify patterns in data to explain natural events.

SI-M-A5 *Developing models and predictions using the relationships between data and explanation*

GLE 6-8/No.

14. Develop models to illustrate or explain conclusions reached through investigation.
15. Identify and explain the limitations of models used to represent the natural world.
16. Use evidence to make inferences and predict trends.

SI-M-A7 *Communicating scientific procedures, information and explanations*

GLE 6-8/No.

19. Communicate ideas in a variety of ways (e.g., symbols, illustrations, graphs, charts, spreadsheets, concept maps, oral and written reports, equations).
22. Use evidence and observations to explain and communicate the results of investigations.

SI-M-A8 *Utilizing safety procedures during scientific investigations*

GLE 6-8/No.

23. Use relevant safety procedures and equipment to conduct scientific investigations.

SI-M-B1 *Recognizing that different kinds of questions guide different kinds of scientific investigations*

GLE 6-8/No.

25. Compare and critique scientific investigations.
27. Recognize that science uses processes that involve a logical and empirical, but flexible, approach to problem solving.

SI-M-B2 *Communicating that current scientific knowledge guides scientific investigations*
GLE 6-8/No.

28. Recognize that investigations generally begin with a review of the works of others.

SI-M-B3 *Understanding that mathematics, technology and scientific techniques used in an experiment can limit or enhance the accuracy of scientific knowledge*

GLE 6-8/No.

31. Recognize that there is an acceptable range of variation in collected data.

SI-H-A2 *Designing and conducting scientific investigations*

GLE HS/No.

4. Conduct an investigation that includes multiple trials and record, organize and display data appropriately.

SI-H-A4 *Formulating and revising scientific explanations and models using logic and evidence*

GLE HS/No.

7. Choose appropriate models to explain scientific knowledge or experimental results (e.g., objects, mathematical relationships, plans, schemes, examples, role-playing, computer simulations).

Science and the Environment

SE-M-A3 *Defining the concept of pollutant and describing the effects of various pollutants on the ecosystem*

SE-M-A4 *Understanding that human actions can create risks and consequences in the environment*

GLE 7/No.

39. Analyze the consequences of human activities on ecosystems.

SE-M-A5 *Tracing the flow of energy through an ecosystem and demonstrating knowledge of the roles of producers, consumers and decomposers in the ecosystem*

SE-M-A7 *Demonstrating knowledge of the natural cycles, such as the carbon cycle, nitrogen cycle, water cycle and oxygen cycle*

GLE 7/No.

41. Describe the nitrogen cycle and explain why it is important for the survival of organisms.

SE-H-A6 *Describing and explaining the Earth's biochemical and geochemical cycles and their relationship to ecosystem stability*

GLE HS/No.

7. Illustrate the flow of carbon, water, oxygen, nitrogen and phosphorus through an ecosystem.

Life Science

LS-M-A3 *Observing and analyzing the growth and development of selected organisms, including a seed plant, an insect with complete metamorphosis and an amphibian*

GLE 7/No.

5. Compare complete and incomplete metamorphosis in insects (e.g., butterflies, mealworms, grasshoppers).

6. Compare the life cycles of a variety of organisms, including non-flowering and flowering plants, reptiles, birds, amphibians and mammals.

LS-M-C4 *Explaining the interaction and interdependence of nonliving and living components within ecosystems*

GLE 7/No.

29. Predict the impact changes in a species' population have on an ecosystem.

LS-M-D1 *Describing the importance of plant and animal adaptation, including local examples*

GLE 7/No.

30. Differentiate between structural and behavioral adaptations in a variety of organisms.

31. Describe and evaluate the impact of introducing non-native species into an ecosystem.

LS-M-D2 *Explaining how some members of a species survive under changed environmental conditions*

GLE 7/No.

32. Describe changes that can occur in various ecosystems and relate the changes to the ability of an organism to survive.

33. Illustrate how variations in individual organisms within a population determine the success of the population.

LS-H-C1 *Exploring experimental evidence that supports the theory of the origin of life*

GLE HS/No.

15. Compare the embryological development of animals in different phyla.

LS-H-C6 *Comparing and contrasting lifecycles of organisms*

LS-H-D3 *Investigating population dynamics*

GLE 10/No.

26. Analyze the dynamics of a population with and without limiting factors.

LS-H-D4 *Exploring how humans have impacted ecosystems and the need for societies to plan for the future*

GLE 10/No.

27. Analyze positive and negative effects of human actions on ecosystems.

LS-H-F3 *Recognizing that behavior is the response of an organism to internal changes and/or external stimuli*

GLE 10/No.

35. Explain how selected organisms respond to a variety of stimuli.

Physical Science

PS-M-A3 *Grouping substances according to similar properties and/or behaviors.*

PS-H-A1 *Manipulating and analyzing quantitative data using the SI system*

GLE HS/No.

2. Gather and organize data in charts, tables and graphs.

PS-H-D2 *Comparing, contrasting and measuring the pH of acids and bases using a variety of indicators*

GLE HS/No.

23. Classify unknowns as acidic, basic and neutral using indicators.

33. Calculate pH of acids, bases and salt solutions based on the concentration of hydronium and hydroxide ions.

Earth and Space Science

ESS-H-B1 *Illustrating how stable chemical atoms or elements are recycled through the solid earth, oceans, atmosphere and organisms*

GLE HS/No.

13. Explain how stable elements and atoms are recycled during natural geologic processes.

Language Arts

ELA-1-M1 *Using knowledge of word meaning and developing basic and technical vocabulary using various strategies (e.g., context clues, idioms, affixes, etymology, multiple-meaning words)*

GLE 6/No.

1. Identify word meanings using a variety of strategies, including: using context clues, using structural analysis, determining word origins, using knowledge of idioms, explaining word analogies.
3. Develop specific vocabulary (e.g., scientific, context-specific, current events) for various purposes.

GLE 7&8/No.

1. Develop vocabulary using a variety of strategies, including: use of connotative and denotative meanings, use of Greek, Latin and Anglo-Saxon base words, roots, affixes and word parts.

ELA-1-M3 *Reading, comprehending and responding to written, spoken and visual texts in extended passages (e.g., ranging from 500 to 1,000 words)*

GLE 6/No.

6. Answer literal and inferential questions in oral and written responses about ideas and information on grade-appropriate text, including: comic strips, editorial cartoons, speeches.

GLE 7&8/No.

4. Draw conclusions and make inferences in oral and written responses about ideas and information in grade-appropriate texts, including: instructional materials, essays, dramas.

ELA-1-M4 *Interpreting (e.g., paraphrasing, comparing, contrasting) texts with supportive explanations to generate connections to real-life situations and other texts (e.g., business, technical, scientific)*

GLE 6/No.

7. Explain the connections between ideas and information in a variety of texts (e.g., journals, technical specifications, advertisements) and real-life situations and other texts.

GLE 7&8/No.

5. Interpret ideas and information in a variety of texts, including periodical articles, editorials and lyrics, and make connections to real-life situations and other texts.

ELA-1-H3 *Reading, critiquing and responding to extended, complex written, spoken and visual texts*

GLE HS/No.

4. Draw conclusions and make inferences in oral and written responses about ideas and information in texts, including: nonfiction works, short stories/novels, five-act plays, poetry/epics, film/visual texts, consumer/instructional materials, public documents.

ELA-1-H4 *Interpreting complex texts with supported explanations to generate connections to real-life situations and other texts (e.g., business, technical, scientific)*

GLE HS/No.

5. Explain ways in which ideas and information in a variety of texts (e.g., scientific reports, technical guidelines, business memos, literary texts) connect to real-life situations and other texts.

Mathematics

M-1-M *Applying concepts of length, surface area, volume, capacity, weight, mass, money, time, temperature and rate to real-world experiences*

GLE 6/No.

18. Measure length and read linear measurements to the nearest sixteenth-inch and mm.

M-6-M *Demonstrate connection of measurement to the other strands and real-life situations.*

D-1-M *Systematically collecting, organizing, describing and displaying data in charts, tables, plots, graphs and /or spreadsheets*

GLE 8/No.

34. Determine what kind of data display is appropriate for a given situation.
35. Match a data set or graph to a described situation and vice versa.

D-2-M *Analyzing, interpreting, evaluating, drawing inference and making estimations, predictions, decisions and convincing arguments based on organized data (e.g., analyze data using concepts of mean, median, mode, range, random samples, sample size, bias and data extremes)*

GLE 6/No.

30. Describe and analyze trends and patterns observed in graphic displays.

GLE 7/No.

33. Analyze discrete and continuous data in real-life applications.

GLE 8/No.

41. Select random samples that are representative of the population, including sampling with and without replacement and explain the effect of sampling on bias.

D-1-H *Designing and conducting statistical experiments that involve the collection, representation and analysis of data in various forms (Analysis should reflect an understanding of factors such as: sampling, bias, accuracy and reasonableness of data.)*

GLE 11 & 12/No.

17. Discuss the differences between samples and populations.

D-7-H *Making inferences from data that are organized in charts, tables and graphs (e.g., pictograph; bar, line or circle graph; stem-and-leaf plot or scatter plot)*

GLE 9/No.

28. Identify trends in data and support conclusions by using distribution characteristics such as patterns, clusters and outliers.

GLE 10/No.

22. Interpret and summarize a set of experimental data presented in a table, bar graph, line graph, scatter plot, matrix or circle graph.

Creative Arts

VA-CE-M2 Selecting and applying media, techniques and technologies to visually express and communicate

VA-CE-M3 Using the elements and principles of design and art vocabulary to visually express and describe individual ideas

Appendix IV

Glossary

Acid – a solution or substance having a pH lower than 7, indicating that it has a high concentration of hydrogen ions. One example of an acid is lemon juice.

Aerobic – a metabolic process that uses oxygen.

Alkaline – a substance having a pH greater than 7, indicating it has a low concentration of hydrogen ions. An alkaline substance is also called a base. Ammonia is an example of a base.

Ammonia (NH₃) – product of the decomposition of plant matter and human and animal waste in water. Some ammonia can be absorbed by aquatic plants, but most ammonia is broken down further into nitrite and nitrate by bacteria.

Ammonia compounds – includes ammonia (NH₃) and ammonium (NH₄⁺).

Ammonium (NH₄⁺) – ionized form of ammonia.

Anaerobic – a metabolic process that does not use oxygen.

Aqueous – a solution that is mostly water.

Ballast water – water that is taken up into the ballast of the ship. The ballast is a compartment located between the outside and the inner hull used to balance the ship full of cargo. The water is released when the ship enters a port.

Base – See alkaline.

Broadcast spawn – simultaneous release of gametes (eggs and sperm) in the water column. Paddlefish eggs are scattered over shoals of sand, gravel, boulders or mussel beds.

Brood – young of animals.

Brood stock – adult population of fish that spawn in a given year.

Cabbage water indicator – solution made from red cabbage that is used to measure the pH of a substance.

Cartilaginous – made of cartilage. Paddlefish are cartilaginous; their skeletons are made of cartilage not bone.

Cleavage – series of cell divisions in a fertilized egg.

Clitella – a saddle-like sac in the body wall of an earthworm that secretes a mucous layer during copulation. The mucous layer hardens into a tough, chitin-like band that forms a cocoon.

Compost – a mixture of decaying organic matter that has nutrients to improve the soil.

Conservation – actions to manage or improve the health of an ecosystem, ecotone, habitat or species.

Copepod – a small crustacean living in fresh and/or salt water. The body of the copepod is slender and segmented; its antennae allow it to drift in the water. There are 9,000 species of copepods. Most crawl or swim, but at least one-third live as parasites on fish and invertebrates.

Critical conditions – chemical, biological and physical conditions that must be met in order for something to occur.

Critically imperiled – informal term for very small or rapidly declining population that is at risk of extinction.

***Daphnia* spp.** – small freshwater crustaceans commonly known as water fleas.

Dentary – the jawbone of a paddlefish. It is the fish's only bony structure. Dentaries can be cross-sectioned, and the age of the fish can be determined by the growth rings.

Deionized water – has a pH of 7, which is neutral. This means the level of hydrogen ions (H⁺) and hydroxide ions (OH⁻) in pure water are equal.

Drought – a long period of time without rainfall that negatively affects growing or living conditions.

Electroreceptors – specialized organs that sense mild electronic current. Tens of thousands are located on the rostrum, opercular flap and head of the paddlefish. The receptors respond to microvolt-scale electrical emissions of planktonic prey and are used to locate the plankton during feeding behavior.

Embryo – the fertilized egg of a vertebrate after cleavage.

Endangered – in great danger or at risk of ceasing to exist.

Exotic – See nonindigenous.

Extinct – no longer living anywhere on Earth.

Extirpated – a species that no longer exists in a specific geographic area it once inhabited.

Eye-fork length – the measurement from the eyespot to the fork of the tail. This measurement is used instead of total body length in paddlefish because rostrums can be damaged and their lengths vary naturally.

Fecundity – capacity for producing offspring. In paddlefish, it is a general term used to describe the number of eggs produced.

Filter feeder – an animal that uses gillrakers or other modified mouth parts to harvest tiny particles of food from the water column.

Fingerling – small, immature fish less than one year old.

Fish kill – any biological, chemical or physical event that causes a large amount of fish to die.

Flex cam – See video microscope.

Free-living – nonparasitic, living independently of another organism.

Fry – recently hatched fish. It is still considered an embryo.

Gillraker – an arched structure that protects tender gill filaments. In paddlefish, they are modified into numerous elongated structures that augment or increase efficiency in filtering plankton from the water.

Gravel bar – an area on the bottom of a waterbody covered by small rocks.

Habitat – a place where an animal or plant lives and obtains food, water, shelter and living space.

Hard substrate – any solid structure covering the bottom of a waterbody, e.g. logs, gravel and mollusk shells.

Heterocercal tail – a tail fin like that of a shark, with the upper lobe longer than the lower lobe.

Hydroxide – hydroxide ions (OH⁻). Concentration determines the alkalinity of a solution or substance.

Inference – a conclusion based on facts or evidence.

Ion – an atom with extra electrons or missing electrons that make it unstable and ready to react with another atom to form a neutral compound.

KWL chart – a learning tool: K – What do you know? W – What do you want to know? L – What did you learn?

Limiting factor – any physical, chemical or biological condition that interferes with or prevents a population from thriving.

Logarithmic scale – scale in which one unit of change is a tenfold increase of the previous unit.

Metamorphosis – a change in form and often habits of an animal during normal development after the embryonic stage, such as egg to larva to pupa to adult.

Native species – animals or plants that occur naturally in an area.

Nitrate – a water-soluble inorganic form of nitrogen (NO_3) that is a common water pollutant. In the nitrogen cycle, nitrites are broken down into nitrate by bacteria.

Nitrify – a chemical reaction that results in nitrate formation from nitrite. This is usually done by bacteria.

Nitrite – a water-soluble inorganic form of nitrogen (NO_2) that is a common water pollutant. In the nitrogen cycle, ammonia is broken down into nitrite by bacteria.

***Nitrobacter* spp.** – beneficial bacteria that convert nitrite to nitrate.

***Nitrosomonas* spp.** – beneficial bacteria that convert ammonia to nitrite.

Nonindigenous species – plants and animals that live outside their natural geographic boundaries, also referred to as exotic, introduced or non-native.

Non-native – See nonindigenous.

Notochord – a flexible, rod-like structure that forms the main support of the body in the lowest chordates; a primitive backbone.

Nuisance species – a nonindigenous plant or animal that out competes native species for food or habitat and alters the environment.

Occurrence – to exist or be present in a geographic area.

Osmoregulation – regulation of water potential in living cells that allows movement of water across the cell membrane to maintain optimal function.

Ostracod – a small crustacean enclosed in a bivalve carapace that resembles a tiny clam. There are 8,000 different species that live in both fresh and salt water. Most ostracods are benthic (live on the bottom) organisms.

Otolith – ear bone of a fish. When the otolith is cross-sectioned, the rings on the ear bone can be counted like tree rings to determine the age of a fish. Each ring represents one year of life.

pH – the potential of hydrogen. It is the measure of the concentration of hydrogen ions (H^+) in solution. The pH will equal 7 for neutral solutions and increase to 14 with increasing alkalinity and decrease to zero with increasing acidity.

pH indicator – used to determine whether a solution is an acid or a base.

Phytoplankton – microscopic, free-floating aquatic plants.

Plankton – organisms that float or drift in fresh or salt water.

Poach – to kill, collect or hunt an animal or a plant illegally.

Population – two or more individuals of the same kind occupying a specific area.

Predator – an animal that kills and eats other animals.

Prey – animals that are hunted by predators.

Propagation – multiply or increase by natural reproduction.

Protected – Limited in number, therefore, prevented by state laws from being disturbed.

Range – a geographical area in which a species of organisms lives.

Restoration – to return to a former state of existence.

Restricted – governed by laws and regulations that limit the use or harm of something.

Rostrum – a snout-like projection on the head.

Sample population – a small group that represents the characteristics of an entire population.

SOAR (Scope-on-a-Rope) – See video microscope.

Species – a group of organisms that can interbreed and produce more of their own kind.

Species of concern – Informal term indicating that the U.S. Fish and Wildlife Service has some concern for the future well-being of a species that does not receive an Endangered Species Act protection.

Stagnant water – water that is not moving or flowing.

Status – current state of a species' existence.

Threatened – an animal or plant that is likely to become endangered in the future throughout a significant part of its range.

Tree cookie – a cross segment of a trunk of a tree that can be used to find information about the age and past physical environment of the tree.

Urogenital opening – a common passage that functions for both excretion and reproduction.

Venn diagram – an education tool used to show differences and similarities among objects.

Video microscope – a microscope that is attached to a TV/VCR or computer to examine and/or film magnified objects.

Yolk sac – a round sac on the belly that supplies food to the embryo.

Zooplankton – animals that float or drift in the water. Some, such as copepods, spend their entire lives as plankton, while others such as fish, mollusks and crustaceans are planktonic only during larval stages.

Appendix V

Paddlefish Status Chart, Fry Diagram, Aquatic Hours Sheet and Water Quality Monitoring Log

Status of Paddlefish in the United States

State	Status
Alabama	Species not legally classified as threatened, endangered or at risk, but commercial and sport fishing closed
Arkansas	Commercial and sport fisheries
Georgia	Extirpated
Illinois	Commercial and sport fisheries
Indiana	Commercial and sport fisheries
Iowa	Sport fishery
Kansas	Sport fishery
Kentucky	Commercial and sport fisheries
Louisiana	Species not legally classified as threatened, endangered or at risk, but commercial and sport fishing closed
Maryland	Extirpated
Minnesota	Threatened
Missouri	Commercial and sport fisheries
Montana	Commercial and sport fisheries
Nebraska	Sport fishery and species of special concern
New York	Extirpated
North Carolina	Endangered - though apparently extirpated from the state
North Dakota	Sport fishery
Ohio	Threatened and sport fishery
Oklahoma	Sport fishery
Pennsylvania	Species not legally classified as threatened, endangered or at risk, but commercial and sport fishing closed, natural population extirpated
South Dakota	Sport fishery
Tennessee	Commercial and sport fisheries
Texas	Threatened
Virginia	Endangered - though apparently extirpated from the state
West Virginia	Critically imperiled
Wisconsin	Threatened

Paddlefish Fry



1. barbels

2. dorsal fin

3. digestive tract

4. heart

5. heterocercal caudal fin

6. rostrum

7. teeth

8. pelvic fins

9. anal fin

