

THE
JOURNAL
OF
THE LINNEAN SOCIETY.

BOTANY.

VOL. XVIII.

LONDON:
SOLD AT THE SOCIETY'S APARTMENTS, BURLINGTON HOUSE,
AND BY
LONGMANS, GREEN, READER, AND DYER,
AND
WILLIAMS AND NORGATE.
1881.

Dates of Publication of the several Numbers included in this Volume.

Nos.	{ 106,	pp. 1-122,	published August 3, 1880.
	{ 107,		
No. 108,	„	123-194,	„ October 15, 1880.
„ 109,	„	195-263,	„ December 31, 1880.
„ 110,	„	263-367,	„ February 21, 1881.
„ 111,	„	367-419,	„ April 29, 1881.
„ 112,	„	419-473,	„ June 3, 1881.
„ 113,	„	473-525,	„ July 9, 1881.

Index and contents to Vol. XVIII. were published September 30, 1881, in commencement of Vol. XIX.

PRINTED BY TAYLOR AND FRANCIS,
RED LION COURT, FLEET STREET.

~~Q.H.I
L.G.I.
v.18~~

BICMED
WI
LI679
v.18

LIST OF PAPERS.

	Page
AITCHISON, JAMES EDWARD T., F.L.S., Surgeon-Major H.M. Bengal Army.	
On the Flora of the Kuram Valley, &c., Afghanistan. (Part I.)	1
ALLMAN, Professor GEORGE J., M.D., LL.D., F.R.S., &c.	
The Anniversary Address of the President for 1880.—Aspects of Vegetation in the Littoral Districts of Provence, the Maritime Alps, and the Western Extremity of the Ligurian Riviera : a Chapter in the Physiognomy and Distribution of Plants	135
BAKER, JOHN GILBERT, F.R.S., Royal Gardens, Kew.	
A Synopsis of Aloinæ and Yuccoideæ	148
Notes on a Collection of Flowering Plants made by L. Kitching, Esq., in Madagascar in 1879. (Plates VII. & VIII.) ..	264
BENTHAM, GEORGE, F.R.S.	
Notes on Orchideæ	281
Notes on Cyperaceæ ; with special reference to Lestiboudois's "Essai" on Beauvois's Genera	360
BERKELEY, the Rev. MILES J., M.A., F.R.S.	
Australian Fungi (Part II.), received principally from Baron F. von Mueller	383
BIDIE, WILLIAM.	
Remarks on the Indian Coffee-Leaf Disease. (In a letter to JOHN CAMERON, F.L.S., Superintendent Bot. Gardens, Bangalore.)	458
BOLUS, HARRY, F.L.S., and P. MACOWAN, B.A.	
Novitates Capenses : Descriptions of New Plants from the Cape of Good Hope	390

	Page
BROWN, N. E., A.L.S., Herbarium Royal Gardens, Kew.	
On some new Aroideæ; with Observations on other known forms.—Part I. (Plates IV.–VI.)	242
CAMERON, JOHN, F.L.S., Superintendent of the Botanic Gardens, Bangalore.	
Remarks on the Indian Coffee-Leaf Disease. (In a letter from Mr. WILLIAM BIDIE.)	458
CHRISTIE, ALEX. CRAIG.—See under CRAIG-CHRISTIE.	
CLARKE, CHARLES BARON, M.A., F.L.S.	
On Indian Begonias. (Plates I.–III.).....	114
On Right-hand and Left-hand Contortion. (With 3 woodcuts.)	468
On <i>Arnebia</i> and <i>Macrotomia</i> . (With 3 woodcuts.)	524
COOKE, M. C., M.A., A.L.S.	
The Coffee-Disease in South America. (Plate XVIII.)	461
CRAIG-CHRISTIE, ALEX., F.L.S.	
On the Occurrence of Stipules in <i>Ilex Aquifolium</i>	467
DARWIN, FRANCIS, F.L.S.	
The Theory of the Growth of Cuttings; illustrated by Observations on the Bramble, <i>Rubus fruticosus</i> . (With 2 woodcuts.).....	406
On the Power possessed by Leaves of placing themselves at Right Angles to the Direction of Incident Light. (With 17 woodcuts.)	420
DICKIE, Professor GEORGE, M.D., F.L.S.	
Notes on Algæ from the Amazons and its Tributaries	123
HENSLOW, the Rev. GEORGE, M.A., F.L.S., F.G.S.	
On a Proliferous Condition of <i>Verbascum nigrum</i> , L. (Plates XVI. & XVII.)	455
HOLMES, EDWARD MORELL, F.L.S.	
On <i>Codiolum gregarium</i> , A. Braun.	132
MACOWAN, P., B.A., and H. BOLUS, F.L.S.	
Novitates Capenses: Descriptions of New Plants from the Cape of Good Hope	390
MASTERS, MAXWELL T., M.D., F.R.S., F.L.S.	
On the Conifers of Japan. (Plates XIX. & XX., and 18 woodcuts.)	473

	Page
MURRAY, GEORGE, F.L.S., Assistant in the Botanical Department, British Museum.	
On the Application of the Results of Pringsheim's recent Researches on Chlorophyll to the Life of the Lichen	147
PHILLIPS, WILLIAM, F.L.S.	
A Revision of the Genus <i>Vibrissea</i> . (Abstract.)	419
TOWNSEND, FREDERICK, M.A., F.L.S.	
On an <i>Erythraea</i> new to England, from the Isle of Wight and South Coast. (Plate XV.)	398
WATT, GEORGE, M.D., C.M., F.L.S., Professor of Botany, Bengal Educational Service.	
Notes on the Vegetation &c. of Chumba State and British Lahoul; with Descriptions of New Species. (Plates IX.- XIV.)	368

EXPLANATION OF THE PLATES.

- PLATE
- I. BEGONIAS.—Diagrammatic Sections of fruit, seed, and capsule of
 II. { species of *Begonia*, in illustration of Mr. C. B. Clarke's paper
 III. { thereon.
- IV. CRYPTOCORYNE CAUDATA. } Inflorescence and dissections of parts
 V. ARISÆMA PENICILLATUM. } of some Aroidæ by N. E. Brown.
 VI. ARISÆMA PULCHRUM. }
- VII. KITCHINGIA GRACILIPES.
- VIII. RHODOCODON MADAGASCARIENSIS.
 Illustrating new Genera of Crassulacæ and Liliacæ from Madag-
 ascar, described by Mr. J. G. Baker.
- IX. RANUNCULI—*R. sceleratus*, var. *mysuroides*, and *R. pangiensis*.
- X. ARABIS PANGIENSIS.
- XI. VIOLA—*V. serpens* and *V. canescens*.
- XII. ARABIS BIJUGA.
- XIII. PEDICULARIS EXIMIA.
- XIV. ADIANTUM WATTII and ANDROSACE MUCRONIFOLIA.
 Plants and dissections of parts, being new species and varieties
 obtained by Dr. G. Watt in the Himalayas.
- XV. ERYTHRÆE, viz. *E. capitata*, var. *sphærocephala*, and *E. Centaurium*,
 var. *capitata*, auct., illustrating Mr. F. Townsend's paper on an
Erythræa new to England.
- XVI. } PROLIFEROUS *Verbascum nigrum*, the malformed flowers described
 XVII. } by the Rev. G. Henslow.
- XVIII. COFFEE-LEAF DISEASE of South America. Fungi attacking leaves,
 in illustration of Mr. M. C. Cooke's paper thereon.
- XIX. PICEA POLITA. } Branches with cones, bracts, scales, and seeds,
 XX. ABIES VEITCHII. } &c., illustrating Dr. Maxwell Masters's paper
 on the Conifers of Japan.

ERRATA.

- Page 10, line 14 from bottom, for "*vaginata*" read *vaginalis*.
„ 12 „ 15 from bottom, for *Caleianthemum kashmirianum* read *Callianthemum cachemirianum*.
„ 17 „ 14 „ top, for "*Hypopytis*" read *Hypopithys*.
„ 283, line 3 from the bottom, and p. 291, line 5 from the bottom, for "Dr. Pfister," read Dr. Pfitzer.
„ 402, line 10 from bottom, omit "obtusis."
„ 405, figs. 11, 12, Plate XV., refer to *E. Centaurium*, var. *capitata*, auct. ; and note that in fig. 7 of same Plate the artist has accidentally omitted to tip the carpels with the base of the style.

THE JOURNAL
OF
THE LINNEAN SOCIETY.

On the Flora of the Kuram Valley, &c., Afghanistan. By J. E.
T. AITCHISON, F.L.S., Surgeon-Major H.M. Bengal Army.

[Read February 19, 1880.]

I. GENERAL OBSERVATIONS ON THE FLORA AND ON THE
DISTRICTS TRAVERSED.

1. *Introductory Remarks.*

IN the winter of 1878 I accompanied the troops under General (now Sir Frederick) Roberts's command during the advance of the Kuram Field Force into the Kuram Valley, at the taking of the Pêwârkotal, and during its further advance to near the Shutar-Gardan. From what I then saw of the country it appeared to me to be an interesting one in a botanical point of view; and therefore, early in 1879, I proposed to the Quartermaster-General, Major Collett, that it might prove advantageous to science if some one were appointed to accompany the column in the contemplated advance on Kabul. General Roberts at once recommended the proposal to superior authority, which ultimately resulted in my being attached to this force as botanist. I made my arrangements, and joined the force at Kuram on the 14th of April, from which date I commenced to make my collections in earnest. Peace having been proclaimed, no further advance took place. I therefore directed my investigations to the flora of the portion of the country enclosed within the red line traced on the map before you (exhibited at reading of paper).

Owing to the massacre in Kabul, and the simultaneous move of the troops to the front, my plans, for the latter end of the season, had to be altered. My collections had to be hurriedly packed and conveyed out of the country, and many of my museum and living specimens were left behind on account of the difficulty of obtaining carriage; besides it seemed probable that my services as a medical officer would again be required to accompany the army, so that the great point was to succeed in getting my collections deposited in safe keeping. I therefore accompanied them by hurried marches to Thal, and there meeting General Roberts returned by his orders to Alikhél, from which the advance of the army was taking place. Here I received further orders from the General, which were to proceed to England and there collect what information I could during the winter to assist me in the continuance of my work on my return to the force this spring. I arrived in England with my collections on the 29th November, and since then have been at work with them at the Kew Herbarium; and had it not been for the assistance I obtained there, the information I now lay before you could not have been prepared within the time placed at my disposal, as I have to leave England during the first week in March.

To the late much-lamented General Munro I am indebted for the identification and naming of my grasses (this, I believe, was one of the last works on which he was engaged previous to his death); to Mr. Boeckeler for naming my Carices; to Mr. Baker, of the Kew Herbarium, for naming and identifying Leguminosæ and Petaloideæ; to Mr. C. B. Clarke for the naming of my Compositæ; and to Mr. Hemsley for the great assistance he afforded me in working with me daily. When it is known that my collection consists of 15,000 specimens, belonging to 950 species, some idea can be entertained of the hard work it has entailed upon all engaged upon it, especially when it is taken into consideration that the time was so limited.

2. *Geography and General Conformation of the Country.*

The collection of plants, regarding which I now write, was made during the summer of 1879 in Afghanistan territory, along the left bank of the Kuram river from Thal to Pévárkotal, and thence upon the higher plateaux, the basins of the Karaia and Hazárdarakht rivers, tributaries of the Kuram.

Before describing its botanical features I deem it of import-

ance to give a short outline of the geography and general conformation of the country. To secure, therefore, a ready comprehension of the subject, I shall divide the area over which I have botanized into three sections:—The first comprising that portion of the valley of the Kuram river which lies between Thal and Badishkhél; the second, the left bank of the Kuram from Badishkhél to Péwárkotal; the third, the basins of the Karaia and Hazárdarakht rivers from Péwárkotal to Serátígah. It will be found that these three geographical sections are coincidentally three fairly distinct botanical areas, each having a flora more or less peculiar to itself.

Valley of the Kuram river between Thal and Badishkhél.—The altitude of Thal above the sea-level is 2500 ft., and that of Badishkhél 4000 ft., the distance between the two localities being about 50 miles. The road followed runs along the left bank of the river, occasionally, however, crossing spurs of conglomerate. The course of the river from Badishkhél is south, slightly east; its bed is wide and shallow, in some places being nearly a mile broad; but at Thal, where the spurs of conglomerate approach on both sides and some igneous rocks also occur, it becomes considerably contracted, making it extremely dangerous to ford at any time.

From Badishkhél to Péwárkotal.—The course of the Kuram river in this district is almost due east, until reaching Badishkhél, where it suddenly bends to the south. On its right bank it is skirted by a set of low hills scarcely reaching 7000 ft. in elevation. The left bank is likewise at first skirted by similar low hills, along which the road runs. The valley on this side becomes gradually more open, owing to the hills of the Safed-Koh range receding, as it were, from the river, leaving extensive open plains, until at length the distance between the hills and the river attains to fully 8 miles at Kuram, widening still more towards the west.

Kuram is a large village and fortress situated on the left bank of the river, at an altitude of nearly 4800 ft., and is about 20 miles west of Badishkhél. A good view of this part of the country is obtained from the Darwazagai pass, situated 6 miles to the south of Kuram, and at an altitude of nearly 5000 ft. From this point of view the river is seen flowing sluggishly in several channels from west to east, through richly cultivated land watered by irrigation. Beyond the cultivation extend vast plains composed of numerous fan-shaped masses intersected by the channels of

the many streams which form the tributaries of the Kuram from the north. These plains gradually ascend until they are lost in the low hills which form the bases of the Safed-Koh range. These again rapidly rise to an average of 14,000 ft., the two highest peaks occupying the extreme ends; that on the east, called Karaia, is 15,400 ft., and that on the west, called Síkarám, is 15,600 ft. in height. From the southern shoulder of the latter a spur runs to the south, reaching almost as far as the Kuram river: this is the Péwárkotal range, forming the western boundary of this area, which for the future will be alluded to as the *Kuram District*.

Basins of Karaia and Hazárdarakht rivers.—The Péwárkotal range on its eastern aspect presents a precipitous face to the depth of nearly 1500 ft. The summit of the road leading across this range is called the Péwárkotal, or pass of the Péwár, and is 8500 ft. in height. Another spur runs from Síkarám to the west, ending in a peak called Matúngé, about 12,700 ft. in height. The country enclosed within these two ranges constitutes the basin of the Karaia river, and is known as the *Hariáb District*. At Alikhél, distant some 18 miles from the Péwárkotal, the Karaia river joins the Hazárdarakht at an elevation of 7000 ft. The river formed by the union of these two streams subsequently falls into the Kuram. The Hazárdarakht river rises from the western base of Mount Serátigah; at first its course is north-east for 15 miles, then to the south-east for the same distance, when it joins the Karaia river, as already stated, at Alikhél.

3. *Vegetation of the road from Thal to Badishkhél.*

The general aspect of the country between Thal and Badishkhél is not a promising one for the botanist. The low hills are bare and treeless, covered with a small meagre jungle, which, however, becomes thicker and of a greater height in the hollows of the country and ravines, where it is protected from the climate and where more moisture is present. Along the river-banks there are a few trees with a large grass; and here, in the vicinity of the river or along irrigation channels, we come across some cultivated trees.

The following shrubs constitute the greater portion of the jungle on the hills:—*Acacia modesta*, *Tecoma undulata*, *Sageretia Brandrethiana*, *Gymnosporia spinosa*, a form of *Zizyphus vulgaris* resembling *Z. nummularia*, *Ehretia aspera*, *Withania coagulans*,

Periploca aphylla, *Adhatoda Vasica*, several *Grewia*, and *Chamærops Ritchieana*.

In the somewhat sheltered localities and ravines *Reptonia buxifolia* occurs as a small dense tree with very dark green foliage. This completely replaces *Olea cuspidata*, Wall., which here, except in sacred groves, is not to be found. *Pistacia integerrima* also occurs, and occasionally *P. cabulica*, a tree quite new to me, with some bushes of *Dodonæa*.

On the banks of the river are to be found a *Tamarix*, *Dalbergia Sissoo*, *Nerium odorum*, a *Saccharum*, *Zizyphus Jujuba*, and *Z. oxyphylla*, with the following cultivated trees:—*Morus alba*, *Salix acmophylla*, another *Salix* (near *babylonica*), and *Melia Azederach*. Frequently occurring as scandents, amongst the above, are seen *Cocculus Leeba*, *Asparagus* sp., and *Ephedra* sp.

The village of Thal, at an altitude of 2500 ft., is situated in a hollow surrounded by low hills. Thus sheltered from the cold winds of winter, its climate approximates that of the Punjab, to which also its flora assimilates—as, in addition to the plants already mentioned, *Salvadora oleoides* occurs as a tree, and at one locality *Ricinus communis* is common. *Capparis aphylla*, a typical Punjab form, however, does not exist.

As one ascends the river, Punjab hot-country types, such as *Dalbergia* and *Calotropis*, accompany one as far as Ahmad-i-Shâma, and are then lost; and here a more northern flora is first observed, in cultivated trees of *Platanus*, walnut, *Celtis*, and the vine as an enormous climber. The changes in the hill-jungle take place much more gradually; *Acacia modesta* is the first to be left behind, its place becoming occupied by a small bush (*Caragana*), with patches of *Ebenus stellata*.

On reaching the more open valley surrounding the village of Hâzar Pir, *Chamærops Ritchieana* is seen for the first time in its full growth, not merely as a handful of leaves attached to a large creeping root, which represents its form on Mt. Tilla and the Salt Range, but developed into a bush of from five to seven feet in height, close masses of which extend for miles across the open plateaux. Frequently, too, it may be seen occurring as a branching tree of from 15 to 25 ft. in height, but then usually when in the vicinity of other trees or buildings.

Here, also, in the rich alluvial soil of the fields, are great clumps of old myrtle, which, from its peculiarly local growth, though occurring in numerous patches, is suggestive of cultivation.

On approaching Badishkhél, *Sophora mollis*, a true Punjab and Salt-Range form from an altitude of 2000 ft., *Daphne oleoides* and *Cotoneaster nummularia*, outer Himalayan forms from 5000 ft., are seen to mix with the jungle, and at length to form its greater proportion, and they continue characteristic almost to 10,000 ft., in whatever direction I have travelled. Other Salt-Range forms which have been hitherto gradually associating themselves with the above become here more frequent, namely:—*Convolvulus lanuginosus*, growing in hummocks, *Onosma echioides*, *Salvia Moorcroftiana*, *Astragalus polyacantha*, and *Otostegia limbata*.

The cultivation up to Badishkhél is similar to that of the Kohat district, or to such portions of the Punjab as are cultivated by irrigation. *Sorghum vulgare* and *Penicillaria spicata* as field crops cease to occur beyond this limit.

At Badishkhél I noticed one large tree of *Pyrus variolosa* which was not cultivated. It is to be found probably in some of the valleys in this neighbourhood, as the natives seem well acquainted with it.

4. *Vegetation of the road from Badishkhél to the village of Kuram.*

The valley is much contracted until it turns fairly to the west, when it rapidly widens, admitting of greatly increased cultivation along the banks of the river. I would here remark that there is no cultivation in the whole Kuram district without irrigation.

The hills on either side of the river consist of boulders, shingle, and conglomerates, interspersed with much broken-up limestone, having on the surface little or no soil, and being scantily clad with a dwarf stunted jungle. This jungle consists chiefly of *Zizyphus vulgaris*, *Periploca*, *Sageretia*, *Daphne*, *Sophora*, *Cotoneaster*, *Punica*, *Dodonæa*, *Chamærops*, *Withania*, *Otostegia limbata*, *Astragalus polyacantha*, and amongst them the new types (8) *Caragana* ? *ulicina* and *Xiphion Stocksii*, remarkable for its handsome deeply purple-coloured flowers, and in its extending its habitat from this to the Hariáb district. *Convolvulus lanuginosus* covers the more open and stoneless ground in great beds, with an occasional *Eremostachys* (No. 16), a handsome yellow-flowered species. Near villages, plauë-trees from 12 to 16 ft. in girth, *Melia Azederach* (attaining 8 ft. 6 in. in girth)

Zizyphus, *Morus*, *Elæagnus*, and *Diospyros*, of ordinary size, are all numerous.

On approaching Kuram, gardens become more common around villages, and enclosing them hedges are composed of *Elæagnus* and *Buddleia crispa*, Benth. Between the fields *Ficus caricoides* and an occasional *Celtis* occur. In the fields themselves *Tulipa stellata* is to be seen, from its typical form gradually changing to what it is impossible to distinguish from *T. chrysantha*, Boiss., the deeper yellow form being more common on the dry conglomerate formation. In clay-fields *Morea Sisyrynchium* abounds, and amongst stems and under bushes, wherever a little soil may have accumulated, the turnip-rooted *Nepeta* with its pretty purplish flowers constantly appears.

5. *Vegetation of the Kuram Plains.*

Beyond the cultivation to the north extend the Kuram plains, the vegetation of which I shall now describe. These plains, formed from mountain débris deposited to a great depth, are in summer totally devoid of water, whether from permeation or rain. In winter they are covered with snow to a greater or less extent; and, being also exposed to the extreme heat of a subtropical sun, alternating with blasts of cold wind from the snow-clad hills, their flora must be limited and of a peculiar type.

The plants which occur most frequently are:—*Othonopsis intermedia*, a large-flowered yellow composite, with fleshy vertical leaves; *Stachys parviflora*, in a very woolly state; *Gypsophila Stewartii*, occurring in small dense prickly tufts, which in its spring costume is of a mossy green colour, thickly covered with purplish flowers; several *Astragali*, namely, *anfractuosus*, *decemjugus*, *hippocrepidis*, *leucocephalus*, *polyacanthus*, *psilacanthus*, *strobiliferus*, *kuramensis*, Baker, *anganus*, *ptilocephalus*, Baker, and *susianus*, Boiss., var. (this last occurs in dense clumps, which present a very showy appearance when in full blossom, owing to its bright pink corolla); two new species of *Onobrychis*, viz. *dasycephala*, Baker, and *microptera*, Baker, with very handsome flowers; a large-flowered *Scabiosa* (no. 82), also probably new, and equally common with it *Scabiosa Olivierii* and *Aster altaicus*. Where there is much clay and fewer stones *Gymnandra armena* carpets the ground with its exquisite little flowers; it is common from this to the Péwarkotal, where it will be again noticed. *Thymus Serpyllum* and *Convolvulus lanuginosus* are common, and here and there the large

yellow flowers of *Scorzonera mollis* are to be seen, apparently for its maintenance collecting a supply of moisture in its bulbous roots.

In the more sheltered parts and hollows are to be found some occasional patches of *Ebenus stellata*, *Buddleia crispa*, with a stunted unrecognizable *Berberis*, and our steady friends the *Sophora*, *Daphne*, *Cotoneaster*, and *Perowskia*. In the deep cuttings of the winter torrents, on their shady side, *Isatis tinctoria*, with its large cabbage-like leaves, appears conspicuous : it is well known, being employed in dyeing by the natives ; indeed this fact guided me in recognizing the plant. Besides these *Salvia glutinosa* and *S. rhytidea* occur (both handsome in their way, and usually in the very centre of the dry watercourse), *Verbascum Thapsus* and *V. eriantha* are common, the latter more prominent from its branching inflorescence.

To certain localities on these plains water is conducted from long distances and run into tanks, where it is collected for the use of the cattle and sheep which graze in their vicinity. Attempts have been made to obtain water by digging wells, but, owing to the great depth of the gravel-deposit, these efforts have always ended in failure.

6. *Vegetation of the Flanks of the Safed Koh.*

Along the base of the Safed-Koh range numerous valleys are seen debouching upon these plains. At these openings, and where the water from the outcoming streams can be utilized for cultivation, the largest villages of the Kuram district occur. The most important of these is Shálizán, situated about ten miles north-west of Kuram at an altitude of 6300 feet. It is composed of several small villages occupying either side of the Durban stream, the size of each village depending upon the amount of water available for cultivation. Until one has actually seen the arboreous and field cultivation that exists here, it is impossible to credit it, reminding one more of some of the best parts of Kashmir than what one would expect so near to the sterile plains just alluded to.

This extreme fertility is no doubt due to the richness of the soil, abundance of water, the favoured position (sheltered, as it is, from the predominating bleak winds by the closely encircling hills), and to the resulting mildness of its climate.

The characteristic trees found here are :—the Oriental plane,

having a girth of from 14 to 25 feet, one old tree measuring 33 feet; the walnut, many trees of which average 12 feet, and there is one exceptional tree 17 feet; the Amlok (*Diospyrus Lotus*), very numerous, tall, but of no great girth. These, with an occasional large mulberry, form extensive groves spread irregularly through the villages, the plane being grown for its shade and shelter, the walnut and "Amlok" for their fruits, which form a considerable portion of the food of the inhabitants during winter.

Orchards are common, and contain the following trees, viz. apricot, plum, apple, grape, quince, and *Elæagnus*. From all of these fairly good fruit is obtained, but not equal to that imported from the Kabul direction. The pear, peach, pomegranate, and cherry are exceptional. I do not remember having met with the almond cultivated.

In gardens and near shrines *Rosa damascena*, *R. Webbiana*, *R. Eglanteria*, *Iris pallida*, and *Althæa rosea* are cultivated, with *Melia Azederach*, the olive, *Celtis*, and an *Elæagnus*, the flowers of which are sweetly scented.

The soil yields two crops during the year, the first being barley, wheat, and clover, the second rice, maize, and one of the millets. Cotton is only grown in the more southern parts of the district to the east of Kuram. Tobacco and opium may be considered garden produce.

The clover cultivated is *Trifolium resupinatum*, the seed of which is obtained from the Hariáb district, because that produced in the Kuram district, it is said, does not germinate.

In the wheat-fields, growing as if it were a weed, and considered as such by the natives, is what has been identified as *Secale Cereale*, (common rye). This in time almost extirpates the wheat, and is considered injurious as food. It does not occur in fields of barley, because that crop ripens before the seed of the rye can come to maturity. As vegetables the natives cultivate onions, beetroot, turnips, radishes, brinjals, red pepper, pumpkins, cucumbers, melons, and water-melons. The whole of the land irrigated is carefully terraced; and in many places, to protect the water-channels or to guide the streams towards these channels, willows are planted; those in the Kuram district are *S. acmophylla* and a species near *babylonica*, and occasionally *Populus alba*, with its variety *denudata*. Hedges are common, usually consisting of *Prunus*, *Elæagnus*, and sometimes, but rarely, of *Zizyphus vulgaris*, which for this purpose is much more common near Kuram. Under the

shade of the cultivated trees, *Stipa sibirica* is profuse, and is well known as a grass poisonous to horses and cattle. It occurs in similar localities throughout the Kuram district, extending as far west and up to the Péwarkotal.

The directly southern exposure of the Safed-Koh range up to an altitude of 7500 feet is devoid of forest, and nearly bare of any thing like an undergrowth. The few occasional trees which are to be found consist solely of *Pistacia integerrima* and *P. cabulica*; and forming the little scrub-jungle, there are our companions throughout, the *Daphne*, *Sophora*, *Punica*, *Cotoneaster*, a *Berberis*, *Berchemia*, a variety at least (if not a new species) of *Cotoneaster nummularia*, *Rhamnus persica*, *Rhus Cotinus*, *Syringa persica*, *Caragana brevissima*, and frequently mixing with them *Morina persica*. On all other exposures, except that directly facing the south, or when in the vicinity of water, a luxuriant vegetation exists, amongst which are many Himalayan forms. Here we first meet with *Quercus Ilex*, from a shrub to a large tree, which is found growing in dry localities, often in isolation, as will be hereafter seen; also *Fothergilla involucrata*, largely employed in the construction of wattle and dab houses and of fences; *Cotoneaster bacillaris*, *Buddleia*, *Desmodium tiliæfolium*, *Jasminum officinale* and *J. revolutum*, *Lonicera quinquelocularis*, *Abelia triflora*, *Viburnum cotinifolium*, *Rhamnus purpureus* and *R. dahuricus*, with patches of *Amygdalus*. Creeping through the above occurs *Rosa Webbiana*, *R. moschata*, and *Dioscorea deltoidea*, several *Asparagi*; and close on the ground, in thick clusters, *Smilax vaginata* and *Hedera Helix*, which, curiously enough, does not attach itself to the trunks of trees. Occasionally *Polygonatum multiflorum* and *P. verticillatum* are to be met with. In the more open and dry localities, but still near water, as along irrigation channels, occur *Indigofera Gerardiana*, *Plectranthus rugosus*, and *Perowskia atriplicifolia*, which is met with frequently in great masses by itself, and when in full blossom presents a most attractive appearance.

7. Vegetation of the Valleys of Safed Koh.

To give an idea of the vegetation of the interior of these hills, I shall allude to a few of the more characteristic forms which occur in the flora of the Shéndtoi valley, which opens out upon the plains about four miles to the east of Shálizán. In the ridges and ravines which intersect the country between Shálizán and

the Shéndtoi valley, *Prunus Jacquemontii* and *Berchemia*, sp., are very characteristic. On the left bank of the Shéndtoi river, at the mouth of the valley, lies the village of Katskallé, consisting of some fifteen to twenty houses. Owing to the limited supply of water in the river during the hot months, much of the land here lies uncultivated, and ruins of villages are to be seen scattered about. The bed of the stream here has an altitude of nearly 6800 feet. The entrance up the valley leads through a deep narrow gorge with overhanging precipitous cliffs of great height, consisting chiefly of limestone and slate. Here, on the right bank of the stream, the rocks are seen covered with moss-like masses of *Selaginella sanguinolenta*, *Dionysia tapetodes*, both Siberian types, a new *Saxifraga*, *Aster Amellus*, prominent from its large white flowers; and, hanging from the crevices in bunches, a luxuriant undescribed grass (*Avena oligostachya*, Munro, MS.).

As the valley widens largish trees of the walnut in a wild state occur, and with it *Euonymus fimbriatus*, *Rhamnus purpureus* and *R. dahuricus*, *Fothergilla*, *Staphylea emodi*, and *Syringa emodi*, with pure white flowers. It is curious to note that the last-named plant occupies always a higher position than its congener *S. persica*, and that the two never seem to mingle. At about 8000 feet, *Prunus Padus*, *Taxus baccata*, *Pinus excelsa*, *Abies Smithiana*, and *Quercus Ilex* begin to form a forest. At 9000 feet *Quercus Ilex* disappears, to be replaced by *Q. semecarpifolia*, which in this valley attains to a great size. There is one tree lying cut close to the old encampment of the 23rd Pioneers, which measured 18 feet in circumference and 100 feet in length before any considerable branch was given off.

On the ridges the forest is increased by *Abies Webbiana*; no Deodar or *Juniperus excelsa* occur in this valley. From 8000 to 10,000 feet the valley is characterized by the number of its ferns, signifying a certain humidity of climate not to be met with in any other part of the country visited. The following frequently occur:—*Cystopteris fragilis*, *Asplenium septentrionale*, *A. viride*, *A. Trichomanes*, *A. varians*, *A. fontanum*. The most remarkable Fern collected, however, was *Nephrodium rigidum*, Desv., which now for the first time has been undoubtedly proved to be an Afghan form. This is here very profuse under the shelter of trees or between large boulders. At an elevation of 10,000 feet, *Aspidium Prescottianum* and *Nephrodium barbigerum* are not uncommon; the form of the latter which occurs here seems to unite the two species *N. barbigerum* and *N. Brunonianum*. On the rocks occa-

sionally at 7000 feet, but more commonly from 8000 to 9000 feet, occurs *Rhododendron afghanicum*, a new species, remarkable from the fact of its being a native of a country hitherto considered as unlikely to yield Rhododendrons, far less any new species. It is poisonous to goats, and is reluctantly handled by the natives.

Ulmus campestris, as a good-sized tree, occurs up to 9000 feet its wood is valued for making the rough wooden dishes used by the people. Amongst the forest, from 10,000 feet to a little above this limit, *Betula Bhojpattra*, with *Pyrus Aucuparia* and *P. lanata*, are not uncommon. The bark of the *Betula* is not employed for any economic purpose.

8. *Vegetation of Safed Koh at elevations of 8000–11,000 feet.*

The following shrubs and herbs occur at about 10,000 feet, chiefly in the bed of the valley:—A new species of *Pertya*, a common bush (a rare Japan and Chinese genus), called *P. Aitchisonii* by C. B. Clarke; *Lonicera sericea* and *Myrtillus*; and in the clefts of the limestone rocks, *Wulfenia Amherstiana* and a *Veronica* near *Teucrium*, both remarkable for their respective forms of bright inflorescence; several *Silenes*, *Primula rosea*, *Geranium Wallichii* and *nepalense*, *Impatiens amphorata*, and some species of *Pedicularis*. At and a little above this height, also in the clefts of the rocks, more particularly at a place known as the Marble gorge, *Isopyrum grandiflorum* and *Polypodium clathratum* of Clarke are found. Amongst turf, at 11,000 feet, *Caleianthemum kashmirianum*, *Aconitum Napellus* var. *rotundifolium*, with *Botrychium Lunaria*, occur in great abundance, and about the same place, but on moss-covered stones, *Cryptogramma crispa*.

The limit of forest is usually reached at 11,000 feet; in favoured localities, however, single trees not unfrequently exist up to 12,000 feet. *Pinus excelsa* and *Abies Webbiana* are the two trees which alone occur as dwarf specimens at the highest altitude. Here a bush-jungle begins gradually to replace the forest trees, chiefly composed of *Salix elegans*, *S. grisea*, with another new *Rhododendron*, a large spreading shrub resembling *R. campanulatum* in its mode of growth, and remarkable for the heavy aromatic odour emitted from its leaves. The natives wear occasionally a bunch of these leaves stuck in their turban in lieu of flowers, and when dried

employ them as snuff. These bushes in some localities form such dense thickets that it is almost impossible to work one's way through them. Occasional bushes of *Ribes Grossularia* and *R. rubrum* may be seen on the margin of the forest, where also *Juniperus communis* occurs in great flattened isolated patches. *Rheum Moorcroftianum* is common on exposed ridges formed of loose débris, and with it, but more generally in the hollows, *Polygonum rumicifolium*. The bush-jungle rarely ascends beyond an altitude of 12,000 feet, whence, to the crest of the Shéndtoi ridge, which is at its lowest 12,000 feet, there is little or no vegetation except a species of *Draba*, *Allium senescens*, and *Rheum Moorcroftianum*, with a few grasses and a *Carex*.

9. Vegetation from Shálizán to the Péwárkotal.

Two miles above Shálizán the Durban river is joined on its right bank by the Gandháo stream, which has its source from the eastern spurs of Sikárám. On its left bank is the village of Kaiwás, in the hills to the north of which, at an altitude of 10,000 feet, and under the western shade of some huge rocks, I obtained *Clematis Robertsiana*, a new and handsome species with the largest flowers of the genus. Beside it, but growing on the face of the rock, *Potentilla Collettiana*, also a new species with *Sibbaldia*-like leaves and brilliant yellow flowers, and *Eritrichium sericeum* in great beauty. In this valley, and to the west of it, there is no *Taxus baccata*; the *Deodar* and *Juniperus excelsa* occur as isolated trees, but rapidly increase towards the west, where they form forests. At the junction of the two streams and between them is situated the village of Karríkalla, on the lands of which it is said some crops are raised without irrigation, viz. barley, wheat, *Setaria*, and *Panicum*.

From Shálizán to the Péwárkotal, a distance of some fifteen miles, the first part of the road lies along the edge of the low hills, which are here composed of a coarse slate. From amongst these springs of water issue at intervals, but which, in reaching the gravel and conglomerate formation, suddenly disappear. At some of these spring-heads I found *Epipactis veratrifolia*, a small *Peristylus*, with *Primula denticulata*, var., and *Androsace incisa*. On the eastern exposure of these hills, and in the vicinity of springs, I noticed the plane-tree occurring as if naturalized, and which did not seem to spread downwards following the water, whilst the younger trees occurred higher up the hill, in

places where they could never have been planted, to an altitude of 7000 feet. The same peculiarity I observed in Kashmir on the western face of the Tukt-i-Sulimán. There is a sacred grove of trees surrounding a shrine at one of the largest of these springs, in which is a *Cupressus sempervirens* of great height and measuring 6 feet in circumference, forming a landmark to the surrounding country. Here also are some magnificent trees of a distinct form of *Populus nigra*, the leaves of which are miniature ones. This I subsequently found in great numbers cultivated in the Hariáb district. It occurs as a tree fully 100 feet in height, with a girth of 10 feet 6 inches. The road now crosses over some of the plain country until it reaches the Afghan cantonment of Habíbkalla, situated at an altitude of 6550 feet. From this the road leads westward to the Péwárkotal, crossing, in the immediate vicinity of Habíbkalla, the bed of the Spíngháó river, close to which is a large cultivated *Populus alba*, 10 feet in girth. From this point the road at first passes through nearly three miles of cultivation, belonging to the village of Péwár; it then winds amongst spurs and ravines chiefly of limestone. Here commences a thicket of stunted *Quercus Ilex*, upon the branches of which two species of *Viscum* grow, with a few other shrubs, the most interesting amongst them being a new yellow rose, its first appearance, *Rosa Ecæ, mihi*, a stiff upright bush; and climbing over the *Quercus Ilex*, *Lonicera Griffithii*, one of the grandest things, when in flower, that I have seen here, the contrast being very fine between the enormous bunches of rose-pink flowers and the dark green foliage of the oak. Of course *Sophora*, *Cotoneaster*, and *Daphne* still occur, but in greater luxuriance. Under the dense shade of the oaks, and growing close into the roots, is a species of *Cephalanthera*, which is very common. At 7000 feet occasional trees of *Deodar* and *Juniperus excelsa* are to be seen; and on the precipitous ascent to the Kotal these two trees soon form, with *Quercus Ilex*, a forest; and on the roadside one or two specimens of *Fraxinus Moorcroftiana* are passed. Only when close to the top of the ascent do *Abies Smithiana* and *Pinus excelsa* join the forest.

The Péwárkotal having been reached, a dense forest is seen to occupy its ridges, consisting chiefly of *Deodar* with *Abies Smithiana* and *Pinus excelsa*. In certain localities, as on the crests through the most dense part of the forest, *Abies Webbiana* occurs, and *Juniperus excelsa* is common on the more northern and open

exposures. There is little or no undergrowth; if any, it consists of *Quercus Ilex*, or more generally of *Q. semecarpifolia*, with occasional shrubs of *Sophora*, *Daphne*, and *Cotoneaster*. The drainage from the west of the P  w  rkotal, as previously mentioned, falls into and forms the Karaia river, so that the Hari  b district is now entered upon. To the north, between the Sp  n-gh  okotal and the P  w  r, the ridges of the hills are found to be separated by small meadows resembling in miniature the "mergs" of Kashmir. These are covered with a thick close sward consisting chiefly of *Gymnandra stolonifera* and *Cousinia racemosa*, which latter seems to be kept down to this tufted form by the grazing of sheep. Here early in the season, from under the melting snow, *Merendera persica* grows plentifully. On the left bank of the Karaia river there is little or no cultivation; on the right bank, however, there is a considerable amount, owing to the country being much more open, consisting of a numerous succession of plateaux.

10. *Vegetation of the Hari  b District.*

The climate of the Hari  b district, owing to its altitude, is much colder and drier than that of the Kuram, with a more severe winter. The land produces but one crop during the year, viz. of wheat, barley, maize, rice, two millets (*Setaria italica*, *Panicum miliaceum*), pulses (*Ervum Ervilea*, *Phaseolus vulgaris*, *Glycine Soja*), carrots, and clover (*Trifolium resupinatum*), a few of the Cucurbitace  , and a little tobacco. Near villages are orchards of apricot, plum, and apple, with a few walnut-trees. Gardens are unknown; hence there are no vegetables. The palm, *Celtis*, *Diospyros*, and vine do not grow at this altitude; but occasionally a few mulberry-trees of no great size are to be seen. Cultivated along water-courses for their protection, *Salix* sp. near *sericocarpa*, Anders., a large tree with weeping branches; *S.* sp., a small tree or large bush; and *S. angustifolia*. The two latter are also quite wild in the streams which run down from the hills, but not so in the open river-bed. Along with these *Populus nigra*, var., is by no means uncommon, cultivated, and perhaps wild. Near villages hedges are common of *El  agnus*, *Rosa anserin  folia*, *R. Eglanteria*, *R. canina*, and more rarely of *Hippophae*: climbing over them one very frequently meets *Bryonia dioica*, a western form which extends as far east as Lahul in the Himalaya.

On the outskirts of villages, *Hyoscyamus niger*, *Conium macula-*

tum (for the first time found east of Persia), *Onopordum Acanthium* (an enormous thistle), and *Solanum dulcamara* (growing, as in Britain, through hedges). On uncultivated clay-fields are found *Matricaria disciformis*, *Carum Bulbocastanum*, and a variety of the latter (a favourite food of the wild pig, which is productive of much destruction to cultivated crops when it occurs plentifully amongst them), *Artemisia Tournefortii* (remarkable for its tall *Cannabis*-like appearance), with *Xanthium Strumarium*. The uncultivated ridges and plateaux of conglomerate formation in the open country are covered with a scanty dwarf vegetation consisting of the following:—*Juniperus excelsa*; *Amygdalus eburnea*, occurring in great clusters, and when in flower, the bushes being leafless at the time, presenting a lovely mass of peach colour, and hence well worth cultivating; *Cratægus Oxycantha*, seen sometimes as a good-sized tree, but then near villages or in fields; *Rosa Ecæ*, several *Berberis*, the *Daphne*, *Sophora*, and here both the forms of *Cotoneaster nummularia*. *Phlomis kashmiriana*, when in full bloom, is extremely attractive. A *Trichodesma*, probably a new species, has magnificent large blue borage-like flowers. *Sophora alopecuroides* is found in profusion, but only at one locality, and that near Alikhél; *Scutellaria*, no. 537, is very characteristic from its long tubular yellow flowers tipped with purple; *Lactuca orientalis* and *L. viminea* are both very common and remarkable for their woody and apparently leafless stems; *Cousinias* are also common, *C. racemosa* being here the most frequent; *Aster altaicus*, *Carduus acanthoides*, *Pteroccephalus speciosus* (a very handsome plant), with *Scabiosa Olivierii* and *Atractylis cuneata*, are characteristic, together with several *Artemisia*.

Growing abundantly throughout this scrub-jungle, and readily detected in the early spring from the vivid green of its leaves, and later on by the brilliancy of its yellow flowers, is *Eremurus aurantiacus*, a plant which may be considered as the vegetable proper of the Hariáb district. Also growing among the roots of many of these bushes are *Anemone biflora* with exquisite flowers, *Arum Griffithii*, and, following them a little later in the season, *Fritillaria imperialis*, *Tulipa stellata*, and *T. chrysantha*, with several *Gageas*, besides everywhere *Isatis tinctoria*. Near Bíánkhél, a large village on the right bank of the Karaia about four miles to the north-east of Alikhél, is a piece of meadow-land watered by many springs, on which I found several localized plants:—*Geranimum*, sp., no. 600, *Gentiana aquatica*?, *Glaux maritima*, *Erythræa*

ramosissima, *Ononis arvensis*, *Triglochin palustre*, *Orchis latifolia*, *Primula denticulata*, *Tussilago Farfara*, *Swertia petiolata*, and *Ophelia cordata*. Near this *Taraxacum montanum* is found, as well as in one or two other localities.

Under the shelter of forests, chiefly along the lateral ravines in which the tributaries of the Karaia flow, a variety of shrubs and other plants are found which are more or less local; as, for instance, *Prunus Jacquemontii*, *Ribes orientale* and *R. Grossularia*, *Lonicera Griffithii*, *Fraxinus Moorcroftiana*, two species of *Ephedra*, and a *Leptorhabdos* near *virgata*. In the forest near the Péwárkotal *Eremostachys speciosa* is occasionally met with—a Central-Asian type, a very woolly plant with large yellow flowers on a shortened spike almost growing from the root-stock. Under *Picea Smithiana*, apparently parasitical upon it, *Hypopytis lanuginosa*; and on limestone débris *Althæa rosea*. I here first found a *Nepeta* near *teucrifolia*, which extends from this throughout the Hariáb district to Káratigah. *Phlomis spectabilis*, on the margin of the forest near the cantonments, is extremely handsome; and underneath the trees, where one would expect little to grow, *Astragalus verticillatus* (collected also on the exposed southern face of the lower hills near Shálizán), with *A. rhizanthus*, is very characteristic, and which at first, on finding the leaves only, I mistook for a Rubiaceous plant.

The rocks of the Hariáb district are covered with the following plants:—*Dionysia tapetodes*, being the most characteristic, from its frequency and moss-like habit and its profusion of bright yellow flowers (some of the plants of this seem to have reached a great age, as I have seen a woody root-stock over 6 inches in circumference); *Parietaria officinalis* and *P. debilis*; *Campanula* sp., no. 541; *Seseli sibiricum*, remarkable for its stiff erect appearance, generally found in the most inaccessible localities; *Microrhynchus aspleniifolius* and *Asplenium Ruta-muraria*, which latter may be considered the only fern of the Hariáb district up to 11,000 feet, although in one instance on limestone I picked up a good specimen of *Ceterach*, and heard of a species of *Adiantum* near water at Alikhél. Specimens of *A. Trichomanes* and *A. septentrionale* are very uncommon.

11. *Vegetation of the spurs of the Péwárkotal, Alikhél, and around Síkarám up to an altitude of 13,000 feet.*

On the spurs of the Péwárkotal between Zabardastkalla and

Alikhél, and on the hills between Sikarám and Matúngé up to nearly 10,000 feet, the forest becomes much thinner, and is greatly altered in appearance, owing to the occurrence of *Pinus Gerardiana**. All the more open parts of the country when there is forest is now covered chiefly with this pine, deodar, and *Juniperus excelsa*; the other trees—viz. *Pinus excelsa*, *Abies Webbiana*, and *Picea Smithiana*—occurring rather in the interior of the hills, or on the ridges which reach an altitude of 10,000 ft. Gerard's pine is distinguished at once by the peculiar character of its trunk and branches, which much more resemble those of a stout stunted beech than of a pine. The bark is of light grey colour, which, on close inspection, presents a generally mottled appearance of various hues, produced by the irregular manner in which the outer layers are shed. It is celebrated for its edible nuts, largely used as food by the natives, and which are an article of export from other parts of the country to India.

Along the range which extends westward from Sikarám to Matúngé I obtained a new species of *Eremurus* (a very fine plant with large hollow leaves) and a *Chorispora* near *tenella*, DC.

On two occasions I explored the Hazárdarakht river as far as Káratíghah on the road towards Kabul; and during my first visit I ascended one of the peaks of Serátíghah, the highest of which has an altitude of 13,600 feet. The distance between Alikhél and Káratíghah is about twenty-five miles, the road leading along the bed of the Hazárdarakht stream. The valley of this river nearly as far up as Rokían is open and well cultivated; beyond this, however, it suddenly becomes contracted, and any little cultivation there may be occurs in the lateral valleys, and not along the main stream. Beyond Drékalla cultivation ceases. The altitudes of the above localities are:—Rokían, 7550 feet; Drékalla, 8000 feet; Káratíghah, 9400 feet. On this route the following plants were collected:—Near Alikhél, on the plateaux of the river, *Ruta acutifolia*, DC.; near Rokían, *Acer*, probably *campestre*, a medium-sized tree, but neither flower nor fruit were seen: this is the only *Acer* I have obtained. As a tall woody shrub overhanging the river, no. 852, *Amygdalus* sp., the fruit of which, in its colour and appearance, resembles less the fruit of the almond than the peach. At Drékalla in one locality there exists a scrub-jungle consisting of *Juniperus excelsa*, several *Caraganae*, *Sophora*, both forms of *Cotoneaster nummularia*, *Daphne*, *Amygdalus eburnea*, *Rosa Ecæ*,

* Ten feet in girth by forty in height is an exceptional tree.

two or three species of *Berberis*, a little *Quercus Ilex*, *Lonicera Griffithii*, with several *Artemisias*. Amongst the stony débris on the ridges above the river *Rheum Ribes* is very common; but, strange to say, I could procure no specimens of *B. Moorcroftianum*. Near the rhubarb, *Convolvulus pseudocantabrica* and the two *Eremuri* were common. On the banks of the river, close to the angle near Drékalla, *Hyoscyamus pusillus*, *Isatis tinctoria*, *Cousinia microcarpa*?, and *C. minuta* are frequent, with one specimen of *Hyoscyamus reticulatus*. From Drékalla to Káratigah the stream-bed is very narrow; and here on both sides a purely deodar and *Juniperus excelsa* forest exists without any undergrowth. These deodars are remarkable for the peculiar style of their growth; they are extremely tall, over a hundred feet, with excellent timber, having very short thick-set lateral branches not over 4 or 5 feet in length, and have nearly the same average length all the way up the stem. Covering the ground under this forest are masses of *Ferula Jaeschkiana* and *Prangos pabularia*; both of these were obtained on the hills between Síkarám and Matúngé, but in small quantity.

On the 19th of July I ascended Serátigah, following up a ravine to the south-west. The ascent was very gradual to 11,000 feet; the forest up to this point contained only deodar and *Juniperus excelsa*. Along the watercourse the two species of *Eremurus* were in full seed, and the leaves of *Rheum Ribes* (but not the other rhubarb) in their autumnal tints were common; but not a single specimen of the fruit of the rhubarb could I obtain. *Ferula Jaeschkiana* and *Prangos* were equally common. The former of these has extremely handsome fruiting stems with large masses of fruit all of a deep reddish purple, but much insect-eaten, so that it was nearly impossible to collect sound fruit. Amongst these, *Hordeum caducum*, Munro, was in abundance, and is the fodder-grass of these parts, together with *Stachys* sp., no. 817, *Carex divisa*, with a very woody nearly leafless Composite (*Tanacetum* sp., no. 820), and *Arnebia endochroma*, H. f. & T., remarkable for its flowers varying from a greenish yellow to a deep purple-black.

The forest completely disappears at 11,000 feet, and is replaced with flat masses of *Juniperus communis*, interspersed with great hillocks of *Acantholimon*, enormous ones of *Onobrychis cornuta*, *Gypsophila Stewartii*, and no. 225 a, a larger form, which may prove to be another species. In the shelter of these occurred

a spinous form of *Cicer soongaricum*, and a woody miniature tree-like *Polygonum*, *P. biaristatum*, n. sp. This peculiar lumpy and hummocky form of vegetation only exists up to 12,000 feet, above which the hills are perfectly bare, and any thing that does grow has to be diligently sought for in the crevices of rocks, or in their shelter.

In broken loose débris at 12,500 feet, I found for the first time *Lamium rhomboideum*, with its lovely pink flowers and its handsome soft woolly leaves. At the summit of the peak (13,000 feet) there are found amongst the rocks, *Cystopteris fragilis* (the only fern collected, with the exception of *Asplenium Ruta-muraria*, since leaving Alikhél), with *Oxyria reniformis*, *Valeriana dioica*, *Lonicera glauca* (so close and creeping, that it was very difficult to obtain fragmentary specimens); a very handsome glaucous-leaved *Ligusticum*, probably a new species; and in the clefts of the rock *Iso-pyrum thalictroides* in great perfection and fine flower. On débris a species of *Draba*, no. 825, with *Alyssum persicum*.

12. *Vegetation of the Spurs around Sikarâm.*

I made several excursions along the southern and western slopes of Sikarâm, on one occasion ascending as high as 13,000 feet. Subsequently I ascended the main hill up to 15,000 feet, and a ridge to the north which overlooks a small lake to a height of 14,700 feet. Except on the northern slopes and in sheltered valleys, all the snow had disappeared. On the top of Sikarâm itself there was no snow in August, but I was informed that a large bed existed on its northern slope. In ascending along the bed of the Kurézghar stream at 9000 feet, I collected *Carex vulgaris*, *Allium robustum*, *Astragalus tephrosioides*, an extremely handsome tall-growing plant, which throws out shoots of from 3 to 4 feet in length from a large woody root-stock. From Sergal the forest was very fine, consisting nearly altogether of deodar and *Juniperus excelsa*, with occasional trees of *Pinus excelsa* and *Abies Webbiana*. On the ridge over the left bank of the Kurézghar stream one or two trees of *Pinus Gerardiana* occur; but this is its eastern limit. On the Pévár ridge it does not get further east than two miles to the south of Zabardastkalla. In the deodar forest there is no undergrowth. On the dry limestone soil under the trees *Pedicularis*, no. 487, is very common; and as the forest begins to thin off, owing to altitude, *Onobrychis cornuta* is common in dense circular bushes, which, with *Juniperus com-*

munis, recurva, and *Rhododendron Collettianum*, form the brushwood beyond the limit of forest. Amongst this brushwood occur several species of *Acantholimon*, *Astragalus psilacanthus*, *Onobrychis spinosissima*, several *Artemisias*, numerous *Cousinias*, *Tanacetum* no. 280, *Linum perenne*, both *Macrotomias*, *Leontopodium*, two or three species of *Anaphalis*, and *Poa bulbosa*, *P. laxa*, *Bromus* near *erectus*, growing through the juniper-bushes, *Lilium polyphyllum*, and under their protection *Gentiana* no. 932. Amongst the stones *Sempervivum acuminatum* is very profuse. On gravelly soil on the exposed ridges *Allium*, no. 734, occurs; in loose rubble *Scrophularia*, no. 919, a dwarf species, the branches of which lie close to the ground, with flowers large in proportion to the plant.

At the upper limit of trees, in ascending the ridge above the Shéndtoi to the east of Síkarám, willows are seen to form the greater part of the brushwood. On Síkarám and on the range to its west, owing no doubt to the excessive dryness of the climate, willows do not exist, the *Rhododendron* alone being found, with the new bush types of *Onobrychis* and *Astragalus*.

At spring heads on moss-covered stones, at an altitude of 11,000 feet in occasional localities, the following plants occur:—*Codonopsis ovata*, a *Campanula*, *Inula rhizocephaloides*, *Parnassia ovata*, *Orchis latifolia*, *Primula purpurea* and *P. denticulata*, *Ophelia cordata* and *O. petiolata*, with *Sedum Ewersii* on the overhanging rocks. Among the boulders in the stream-bed *Oxyria reniformis* is by no means uncommon.

From 12,000 to 14,000 feet the following plants occur, but only in patches, otherwise the hill-side appears destitute of vegetation:—*Delphinium Brunonianum*, when in full flower very effective; *Rheum Moorcroftianum*, but no *R. Ribes*; *Bupleurum* sp., no. 929, and *Astragalus*, no. 924 (near *A. confertus*), both very close-growing and carpeting the ground. In the clefts and on the sides of rocks, *Pleurospermum corydalifolium*, *Valeriana petrophila*, *Isopyrum grandiflorum*, *Ligusticum* no. 821. Amongst broken débris, *Nepeta* no. 917, *Lamium rhomboideum* and *Aster heterochæta*, with lovely purple flowers, and the following grasses:—*Poa flexuosa*, *Piptatherium laterale*, *Festuca ovina*, and *Kæleria cristata*.

At 14,000 feet, *Oxygraphis*, a new species, the leaves and flowers of which seem to be a favourite food with the snow-pheasant, as it was almost impossible to get perfect specimens on account of its being invariably eaten over. In the shelter of the boulders

Primula purpurea was very profuse, and with it *Gypsophila sedifolia*, with several *Drabæ*, and occasionally in tufts *Brachypodium tartaricum*. At the highest altitudes the following plants occurred — *Potentilla monanthes* and *P. sericea*, with a *Draba*. Another proof of the extreme dryness of the climate is the total absence of *Anemones*, which at these altitudes in Kashmir occur in abundance.

The only ferns obtained were *Asplenium Ruta-muraria*, up to an elevation of 11,000 feet, and *Cystopteris fragilis*, up to an elevation of 13,000 feet.

13. *Plants cultivated for Food.*

Cereals.—Up to the time of the British occupation cultivation was limited to the actual wants of the people as food, with perhaps a slight surplus for barter ; at least, such was the opinion I formed after numerous conversations with the natives, as well as from my own personal observation. The chief causes of this were, no doubt, insecurity of property, due to the constant occurrence of blood-feuds, the inhabitants being afraid to cultivate except in the immediate vicinity of their villages, and to the inadequate supply of water, an increase of which could not be obtained without incurring extra labour upon works which might never prove profitable. In the whole Kuram and Hariáb districts there is not a single water-course to be compared with the works commonly found in Ladák. No sooner, however, had the British occupation of the Kuram Valley taken place than every bit of land which the villagers were capable of placing under immediate cultivation was at once begun to be worked upon, and persons who had left the country were recalled by their friends to return and till their fields.

The land is rich and good, and, as a rule, those very arid plains already spoken of only require water and labour to convert them into green fields. With a very little trouble and care taken to avoid waste, twice the amount of land could be cultivated with the water already available. For instance, the hills to the north of Shálizán consist of slate, which has been lately worked by Europeans, and found to be of good quality and unlimited in quantity ; and if this slate were employed in the construction of the water-channels, it would assist in economizing the water which is at present wasted, owing to its running over a gravelly soil. As an example of how a good supply of water is allowed to go to waste, at an elevation of 8000 feet, in the Shéndtoi ravine, the stream of that name, where 4 feet broad and 2 feet deep, is allowed to lose itself in a mass of boulders and shingle, whilst the villagers

of Katskallé at the mouth of the gorge were losing their crops from deficiency of water.

In the Kuram district, as elsewhere stated, two crops are obtained during the year—the first consisting of barley, clover, and wheat, the second of rice and Indian corn. Rice taking a longer time to mature, rotates with barley and clover, both of which are early and quick crops. Indian corn follows wheat. The natives manure their fields well, the cow-dung not being, as in India, employed as fuel. Rice is the staple crop, and is not cultivated above 7500 feet. The germination of rice-seed in the seed-nurseries is supposed to be hastened by shading with the young branches of *Adhatoda Vascia* and *Sophora mollis*. The next crop in importance to rice is, I think, Indian corn, as the people of these parts prefer the bread made from it to that of wheat, and which is always made with ferment—a custom which does not obtain to the east of the Indus. I think there is good reason for their preference, as Indian corn-flour is always pure, whereas the wheat-flour of the country is half rye.

I was much struck by seeing in the wheat-fields a plant which I subsequently identified as *Secale cereale*, or common rye. The natives assert that this is a weed, and accidentally occurs amongst the wheat against their wish, but that it is not found amongst barley, which is easily explained by the fact that it takes a much longer period to ripen than barley. The grains of the wheat and rye are very like, and no attempt is made to separate them before they are sown; and it is so common among the wheat as in many cases to predominate. Besides rye, two other weeds commonly occur with the wheat, viz. *Avena fatua* and *Lolium temulentum*. Occasionally after eating wheaten bread, persons are seized with symptoms of narcotic poisoning, and, if not attended to, have been known to die. The natives invariably attribute these symptoms to the seeds of one of these three weeds, and will pick them out from amongst the suspected wheat, in support of their assertion. Wheat, barley, and Indian corn are cultivated in the Hariáb district up to very nearly 9000 feet. Rice is husked in the usual manner in a large mortar with a wooden pestle, or sometimes in mills by cattle power. In the larger villages there are numerous water-mills for grinding the other cereals; frequently, however, hand-mills are also resorted to. I have not seen the Amaranths cultivated*.

* The cultivated fruit-trees and principal vegetables are enumerated at p. 9, *anted.*

14. *Indigenous Plants for Food &c. in use.*

Having mentioned the plants which are cultivated in the Kuram valley, I will now describe such as are employed by the people as a substitute for these or together with them. *Eremurus aurantiacus* is the sole vegetable upon which the inhabitants of the Hariáb district depend for fully two months of the year. The leaves are simply cut off the root-stock, if I may so call it, as close to the ground as possible, leaving the stock intact, but for which the plant would long ago have been extirpated. This as a vegetable was considered very good by the army, and boys brought daily baskets full of leaves into camp for sale. It resembles in flavour no other vegetable I ever tasted, it being hard and crisp without being either tough or fibrous, and it might prove under cultivation a welcome addition to our limited list of spring vegetables. The young shoots of asparagus are collected and cooked, as are also the leaves of the cultivated fig, of *Carum Bulbocastanum* (not the tubers), and, lastly, the rhizomes of *Polygonatum verticillatum*. Between Badishkhél and Thal the stems of *Boucerosia Aucheri* and the young flowering shoots of *Chamærops Ritchieana* are eaten raw, as are also the roots of the turnip-rooted *Nepeta*, which occurs from near Badishkhél to Káratígah. It is curious to note that the bark of this root is flavoured like the turnip, whereas the heart of the bulb has the flavour of fresh almonds. The leaf-stalks of both rhubarbs, of wild onions, the leaves of the common clover (*Trifolium resupinatum*), and the stems of the young flowering shoots of an *Orobanche* which is parasitical upon *Artemisia* are all eaten raw. The stems of the last have not much flavour, but are cool and crisp.

The following Fungi are collected and eaten cooked:—*Morchella esculenta*, *Agaricus campestris*, *Helvella crispa*, and *Hydnum coralloides*; as a precautionary measure the natives recommend them to be cooked with a mixture of fat.

In addition to the cultivated fruits, there are also eaten:—*Berchemia*, here called "Mamáhuea," the name given to a *Sageretia* further east; *Chamærops Ritchieana*, which is sold in the market at Thal, and there called by the same name as dates; *Pyrus lanata*, Don, called by the same name as that given to the fruit of the *Diospyros*; wild plums, blackberries, berberries, *Eleagnus*, strawberries, gooseberries, and *Prunus Padus*, the two latter being called "wild grapes." The nut of the wild almond, the fruit of the pomegranate, and the wild walnut are all uneatable. Mulberries are

not wild, nor have I seen the hazel as a shrub. In the Hariáb district large quantities of gum exude from the stems of the plum and apricot, which is collected and eaten.

15. Fodder for Animals.

In addition to the straw of the cereals and pulses, clover (*Trifolium resupinatum*) is cultivated, and the wild oats and weeds from the field are collected and given to animals. Grass is generally so scarce that the natives supplement it with the young shoots and stems of *Periploca aphylla* to the east of Kuram, and to the west with the foliage of *Quercus Ilex*, especially the variety that is devoid of spines—the two latter affording fodder for camels chiefly; and in the Hariáb district the young branches of the willows are largely resorted to for fodder for both cattle and sheep. The ashes obtained by burning branches of *Ephedra* are mixed with tobacco for the purpose of chewing, or with snuff to intensify its action, and the dried and powdered leaves of *Rhododendron Collettianum* as snuff.

16. Medicines and other Vegetable Products.

The following plants are employed as medicines for internal use:—The berries of *Ribes orientale*, the fruit of *Rhamnus dahuricus*, the roots of *Daphne oleoides* when boiled, and the dried root of *Euphorbia*, sp. (no. 380), are all employed as purgatives, being more or less common household remedies. The last goes by the name of the vomit-weed, and is also used for that purpose. The fresh milk from its leaves blister the hand when collecting it.

As local applications the castor-oil is cultivated in the gardens at Kuram for the sake of its leaves, which are employed in poulticing. The roots of two species of *Arnebia*, viz. *A. endochroma* and *A. speciosa*, are used to relieve toothache and earache. The gum-resin which exudes from the flowering stems of *Ferula Jaeschkiana* is applied to wounds and bruises. At Alikhél a native brought me the stems of a plant which he said was a rare and valuable medicine, calling it "Mam-í-ran"; on examination it proved to belong to some species of *Geranium*, probably *G. Wallichianum*. The root-stocks of *Valeriana Wallichii* are collected and sent to Gandamak for export to India, to be used as a perfume. The juice of the leaves of *Delphinium Brunonianum* is employed to destroy ticks in animals, but chiefly when they affect sheep.

Poisons.—The following plants are known to be poisonous to the natives, viz. *Datura*, *Hyoscyamus*, *Cannabis*, *Atropa lutescens*, and *Solanum Dulcamara*, and, as already mentioned, one of the three weeds found amongst wheat, viz. rye, wild oats, or *Lolium*. The plants poisonous to animals are:—*Stipa sibirica*, a very common grass under the shade of trees and in their vicinity, near Shálizán and similar localities; its poisonous qualities are recognized by the cattle of the country, which never touch it; *Rhododendron afghanicum* is poisonous to goats and sheep.

Oils.—As far as my observations have gone, no oil-seeds are cultivated, nor is any oil extracted from the kernels of the apricot or walnut. The only substance in the country which the natives call oil is a crude tar obtained by distillation from the roots of a conifer. Splinters from the green wood of *Pinus excelsa*, or portions from the roots of *P. Gerardiana*, are employed in place of lights, the pieces of the roots going by the name of Chirágh, meaning lamp. In lieu of vegetable oils for food, the melted fat of the tail of the large-tailed sheep is used.

Charcoal.—This is usually made from the softer pine-woods to save trouble, although the blacksmiths know well that the harder woods yield a better article.

The tears of resin exuding from the bark of *Pinus excelsa* and leaves of *P. Gerardiana* are collected and used for various purposes.

Soap.—The large roots of *Saponaria Griffithii* are collected and employed as soap for washing purposes.

Dyes.—The *Isatis tinctoria* is largely used a local dye; its native name means the “Dye-plant.” At the Mussulman festival of the Id, at which hard-boiled eggs are indispensable, the roots of a *Rubia* are employed to give them a bright red colour.

17. *Forests.*

The forests are extensive and very fine; they contain splendid timber, the chief of course being that of the deodar, which some years ago was exported by the Kuram river to Bunnor. At present the drawback to its exportation is the distance of the forests from the river; this, however, might be easily overcome by the introduction of wooden tramways, such as are already in use in some of the Indian forests. The natives do not employ timber of any size in their buildings, and are not particular as to the kind. Their doors are usually made of deodar,

at a ruinous expense of timber. As a rule, they scarcely ever for their own uses cut down a large tree; and throughout the forests of this district few or no trees are seen partially burnt, as is so commonly the case in Kashmir. When this does occur it is in localities where Afghan or British soldiers have been encamped. I believe the cause of this immunity to be due to the unsafe condition of the country, for benighted travellers who would, do not dare to light a fire lest it might betray their presence.

The following are the measurements of some of the exceptionally large trees which I have seen:—plane tree, in circumference, 33 feet, walnut 17 feet, deodar 21 feet, *Celtis* 16 feet, *Quercus semecarpifolia* 13 feet, *Populus nigra*, var., 10 feet 6 inches.

Near the village Kaiwás, on the road to the forests, I saw timber slides of rather a rude construction for bringing down from the hills poles for roofing houses. Most of the houses are built on the "wattle and dab" principle, and for their construction the stems of *Fothergilla*, *Cotoneaster bacillaris*, *Quercus Ilex*, and willow are usually employed. Household utensils, viz. large platters, bowls, and spoons, are made from the wood of *Ulmus campestris* (called the "carpenter's tree"), of the poplar, willow, and walnut, indiscriminately. The handles of their farm implements, such as axes, hoes, &c., are made from *Cotoneaster bacillaris*, *Fothergilla*, and *Fraxinus*. The small rolling-pin with which is beaten out the leaves of the *Chamærops* into a coarse fibre is always made of a piece of *Quercus Ilex*. Their usual walking-sticks consist of *Cotoneaster bacillaris*; and the wands carried by the priests, or "mollahs," are of the wild almond, and held sacred. For clogs the wood of *Pinus Gerardiana* is preferred but they are also made of the wood of other pines. For making baskets, a particular willow, near *Salix viminalis*, is cultivated in the Hariáb district. The bark of *Caragana ambigua*, Stocks, in entire circular pieces, is used to encircle and keep firm the wooden sheaths of the long Afghan knife. In addition to this being a strong material for the purpose, its bright golden brown colour gives it, when fresh, an ornamental appearance. Portions of the stem of *Arundo*, sp., are employed to hold charges of gunpowder, and are arranged in a row round the waist, as is the custom in carrying breech-loading cartridges.

Fibres.—The leaves of *Chamærops Ritchiana* torn into strips are

the material of which all rope, twine, or string is made in the Kuram valley. As already stated, this plant only occurs as stunted specimens to the east; therefore the whole of the material employed for making rope is imported into the country from the south of the river. The sandals worn by the people in place of shoes are also all made from this, the leaves undergoing in this instance the simple process of damping and beating sufficient to produce a coarse fibre. Any other materials employed to make rope are exceptional; the most common is goat's hair, next the bark of the elm, by merely damping and twisting. The twine which is used for the slow match of their matchlocks is made from the fibre of the bark of the young shoots of the elm, dipped in a solution of saltpetre. The exfoliating epidermis of *Juniperus excelsa* and *Lonicera quinquelocularis* in the Hariáb district is employed when a rather soft than strong material is required, as for making pads for placing under loads when carried. I was informed that from Serátigáh a grass was obtained which made an excellent rope; but the best rope of all, and most valued by traders, is that made from the roots of a small spinous shrub collected in the Logar valley. Owing to the difficulty of extracting the root the following plan is pursued:—A string is first tied lightly round the crown of the root to a long stick, one end of which is used as a lever, the other as the fulcrum; the root breaks away in lengths of from one to two feet.

Barks.—The bark of the birch, *Betula Bhojpattra*, is not employed, nor are its uses known.

Bees and Sericulture.—In every village near the hills in this country bees are largely kept by the people, honey and wax being important articles of traffic. Honey is used in place of sugar, which is very expensive.

Sericulture is carried out on a very small scale, the silk produced being employed solely for home consumption.

II. LIST OF THE PLANTS COLLECTED, WITH NOTES AND
DESCRIPTIONS OF NEW SPECIES.

DICOTYLEDONES.

1. RANUNCULACEÆ.

978. *Clematis grata*, Wall.

Shálizán, 6000 feet.

733. *C. Robertsiana*, Aitchison et Hemsley, n. sp. Fere omnino *C. alpina* (*Atragene alpina*, L., var. β , Ledebour, Flora Altaica, ii. p. 377), sed floribus citrinis pæne duplo majoribus, sepalis longe acuminatis, petalis vel staminibus petaloideis anantheris nullis, etc.

Frutex sarmentosus, præter flores cito glabrescens, ramis gracilibus angulatis usque 4-5-pedalibus. *Folia* longiuscule petiolata, laxè biternatim secta; foliola petiolulata, membranacea, ovato-lanceolata, lateralia sæpissime obliqua, omnia 1-2½-pollicaria, plus minusve grosse mucronulato-serrata, terminalia interdum tripartita, lateralia bipartita. *Flores* citrini, ampli (sepalis usque ad tripollicaribus), terminales, solitarii, longe pedunculati, cernui; pedunculi 3-5-pollicares; sepala 4, sparsim pilosula, venosa, lanceolata, longe acuminata, acuta vel obtusiuscula; petala vel stamina petaloidea ananthera nulla; stamina pilosula, exteriora longiora et subpetaloidea; filamenta omnia dilatata. *Achenia* sessilia, novella longissime sericeo-villosa, matura non visa.

Shálizán stream, June 1879; hill north of Kaiwás, at 10,000-11,000 feet, profuse, July 1879. A handsome semiscandent shrub, with flowers of a pale lemon colour, from 3 to 5 inches in diameter. It is an exceedingly interesting species, forming a connecting-link between *Atragene* and *Clematis* proper, having almost exactly the foliage and flowers (though much larger) of the Central-Asian variety of *C. (Atragene) alpina*; but the flowers are destitute of petals or antherless staminodes, a character in which it appears to differ from all the varieties of the plant in question. Furthermore, although *C. alpina* has such a wide area of distribution, it has not hitherto been found within the limits of Boissier's 'Flora Orientalis'; neither is it known to occur in the Himalayan region. The North-American *C. (Atragene) verticillaris* resembles our plant in having no petals or petaloid antherless staminodes.

718, 614. *C. graveolens*, Lindl.

Common at 7000 feet; July.

118, 101. *Anemone biflora*, DC.

From Kuram to Alikhél, under bushes, at 6000 to 8000 feet ; April.

463. *A.* sp. nov.

From 8000 to 10,000 feet ; June and July.

599, 727. *Thalictrum minus*, L., var. *glandulosum*, Koch.

Hills at Kaiwás and Karchátal, 10,000 to 12,000 feet ; May to July.

0. *T. minus*, L., var. *flexuosum*, Benth.

Alikhél, 7000 feet, profuse.

428. *T. minus*, L., var.

Shálizán to Bíánkhél.

415. *Callianthemum cachemirianum*, Camb.

Hills, Shéndtoi, at 10,000 feet, from melting snow ; end of May.

134. *Adonis aestivalis*, L.

Corn-fields, Habíbkalla, 6500 feet, common ; March to May.

102. *Ranunculus falcatus*, L., var. *orthoceras*.

Alikhél ; April ; 8000 feet.

744, 459. *R. hirtellus*, Royle.

From 8000 to 11,000 feet, common ; May and June.

416. Large-flowered variety of *R. hirtellus* (*nepalinus*, Jacquem.) from Shéndtoi ; May.

18. *R. lætus*, Wall.

Moist ditches and fields, Alizai, Kuram, Habíbkalla ; April and May.

6. *R. arvensis*, L.

Fields, Shálizán to Habíbkalla ; April to June.

598. *R. divergens*, Jordan.

On grass-meadows, Karchátal, 10,500 feet, profuse ; June.

452. *R.* sp. near No. 28744 of C. B. Clarke's K ashmir herbarium.

Kotalmerg ; May.

0. *R. lætus*, Wall., var.

955. *Oxygraphis*, sp. nov.

On shingly débris, where there were no other plants, from 12,000 to 14,000 feet, Mt. Síkarám ; August.

406. *Caltha palustris*, L.

Shéndtoi, 9000 feet ; May.

0. *Isopyrum anemonoides*, Kar. et Kir.

Serátígah, on rocks at 13,000 feet ; July.

0. *Isopyrum grandiflorum*, Fisch.

Mt. Síkarám, 13,000 to 14,000 feet, on rocks, profuse; August.

0. *I. grandiflorum*, Fisch., var.

Mt. Síkarám; August; 13,000 feet.

802. *I. sp.*

Marble rocks, Shéndtoi, at 10,000 feet; July.

376. *Aquilegia vulgaris*, L., var. *pubiflora*?

From 9000 to 11,000 feet, Shéndtoi.

0. *A. vulgaris*, var. *Moorcroftiana*, Wall.732. *A. vulgaris*, var. *fragrans*, Benth.

Kaiwás, 12,000 feet; July.

0. *A. sp. nov.*

A dwarf species, that may be new, from Mt. Síkarám, 10,000 to 14,000 feet; August.

559, 575. *Delphinium uncinatum*, Hook. f. & Thoms.

Alikhél, stony ground, bare hills, common, 8000 feet; June.

957. *D. Brunonianum*, Royle.

Mt. Síkarám, bare side of hill and ridges at 14,000 feet, common; August.

862. *D. sp. near D. tuberosum*, Auch.

In meadows from 8000 to 11,000 feet, Alikhél, Káratígah, Spíngháó. A very beautiful plant. July.

1001. *Aconitum napellus*, L., var. *rotundifolia*, Kar. et Kir.

Amongst grass in meadows at 10,000 feet, Shéndtoi; end of August.

2. BERBERIDÆ.

726. *Berberis callibotrys*, Bienert.

Hills above Kaiwás, 11,000 feet; a large bush; July.

 $\frac{176}{5}$. *B. orthobotrys*, Bienert.

Near Sergal, 9000 to 11,000 feet; August.

490. *B. cretica*, L.

Between Sergal and Síkarám, 8000 to 10,000 feet.

499. *B. sp.*

Base of Síkarám; June.

176. *B. sp.*

Habíbka; May. This is the common *Berberis* between Kuram and Habíbka.

0. *Berberis* sp. With peculiar swollen fruit.
Drékalla ; August 17th.
0. *B.* sp.
Shálizán ; June 18th.
0. *B.* sp.
Hill near Kaiwás, 10,000 to 11,000 feet.
0. *B.* sp.
On dry hilly ground behind village of Shálizán ; 7000 feet ;
May.
0. *B.* sp.
At Kuram Fort ; April.
385. *Podophyllum Emodi*, *Wall.*
At 10,000 feet, up the Shéndtoi gorge ; May.

3. PAPAVERACEÆ.

- 138, 272. *Papaver dubium*, *L.*, var. *lævigatum*.
Kuram to Alikhél, in fields from 6000 to 9000 feet ; May and
June. A very uncommon plant. Curious to see how scarce
the poppies are here in comparison to their abundance in the
Kashmir fields.
860. *Glaucium fimbrilligerum*, *Boiss.*
On dry stony soil near Zabardastkalla ; July.
242. *Rœmeria rhœadiflora*, *Boiss.*
Fields near Kuram ; April ; rare.
- 242a. *R. hybrida*, *DC.*
Fields near Shálizán ; very rare.

4. FUMARIACEÆ.

183. *Hypecoum procumbens*, *L.*
In fields from Kuram to Alikhél, not uncommon ; May and
June.
- 95 and 121. *Corydalis*, sp. near *C. rutæfolia*, *Sibth.*
Common in the forests at roots of trees and bushes ; April.
789. *C. meifolia*, *Wall.*
From 10,000 to 11,000 feet, Shéndtoi ravine, amongst large
boulders, profuse ; July.
210. *Fumaria parviflora*, *Lamk.*
By no means common in fields, 6000 to 10,000 feet ; May.

5. CRUCIFERÆ.

894. *Nasturtium officinale*, *Br.*
Profuse wet ground near spring, Péwárkotal, 8500 feet; July.
276 and 690. *N. palustre*, *DC.*
Common, sides of streams, Shálizán; June.
0. *Barbarea vulgaris*, *Br.*, var. *taurica*, *DC.*
Shálizán to Bíánkhél; from 6000 to 9000 feet, not uncommon;
June.
154. *B. vulgaris*, *Br.* = *Griffith*, *Afghan*. no. 1458.
Habíb-kalla, common.
97. *Arabis nuda*, *Bélang.*
Alikhél; April.
- 97a. *A. nuda*, var. (hirsute pods).
77. *A. amplexicaulis*, *Edgew.*
Shéndtoi; May.
120. *A.* sp.
Alikhél; April 19th.
822. *A.* sp. Flowers white.
Serátigah, at 13,000 feet; July.
141. *A.* sp.?
Shálizán; April 25th.
547. *A.* sp.?
Alikhél; June 9th.
279. *Cardamine Impatiens*, *L.*
Very common near water from Kuram to Shálizán; May.
142. *Alyssum minimum*, *Willd.*
Common on stony ground from Thal to Habíb-kalla; April.
826. *A. persicum*, *Boiss.*
Serátigah; July 19th.
0. *A. campestre*, *L.*
Alikhél; June 9th.
107. *A.* sp.
Alikhél; April 18th.
825. *Draba* sp.
Serátigah, 11,000 to 13,000 feet; July.
464. *D.* sp.
Shéndtoi, 11,000 feet, close to snow; May 31st.
- LINN. JOURN.—BOTANY, VOL. XVIII.

0. *Draba* sp.
Síkarám, 13,000 feet; August 14th.
0. *D.* sp.
Síkarám, 11,000 to 15,000 feet; August 7th.
0. *Malcolmia africana*, *R. Br.*
Common, Alikhél; July.
- 149 and 57. *Sisymbrium Sophia*, *L.*
Very common from Kuram to Habíbkalla; April.
0. *S. himalaicum*, *Hook. f. & Thoms.*
0. *S. strictum*, *Hook. f. & Thoms.*
Shéndtoi; July 8th.
- 12, 209, 200. *S. Wallichii*, *Hook. f. & Thoms.*
Alizai; April 4th.
135. *S. Columnæ*, *Jacq.*
Shálizán; March 25th.
216. *S. Lceselii*, *L.*
Shálizán; May.
91. *S. Alliaria*, *Scop.*
Shálizán to Habíbkalla; April.
206. *Conringia* sp. near *C. perfoliata*, *Crantz.*
Habíbkalla; May.
67. *Erysimum repandum*, *L.*
Kuram; April.
475. *E.* sp.
Between Alikhél and Sergal; June.
402. *Brassica campestris*, *L.*
Most likely an escape from cultivation. Shéndtoi; May.
129. *Capsella Bursa-pastoris*, *L.*
Very common everywhere near cultivation; April.
- 182, 58. *Lepidium Draba*, *L.*
Profuse in fields amongst crops; May.
- 94, 621. *L. latifolium*, *L.*
Shálizán, fields; June 26th.
139. *Thlaspi arvense*, *L.*
Common, Kuram to Shálizán; April.
454. *T. cardiocarpum*, *Hook. f. & Thoms.*
Under pine-trees, Péwárkotal, not common; May.
116. *T. alpestre*, *L.*
Very common, Shálizán to Alikhél; April to June.

78, 251. *Isatis tinctoria*, L.

Very profuse, from Kuram to Serátigah. Employed as a dye-stuff, its native name "Banjowah" meaning "the dye." All summer.

532. *Pachypterygium* sp.

Near Alikhél; June.

181. *Neslia paniculata*, Desv.

Common in fields at Habíbkalla; May.

280. *Euclidium syriacum*, R. Br.

Shálizán; May.

190. *E. tataricum*, DC.

Alikhél, common; April to June.

622. *Raphanus Raphanistrum*, L.

Shálizán; June.

211. *Chorispora tenella*, DC.

Habíbkalla; May.

133. *C. tenella*, var.?

Shálizán to Habíbkalla; April.

597. *C.* sp. near *C. Bungeana*, Fisch. & Mey.

At 11,500 feet up the Karchátal ravine.

6. CAPPARIDÆ.

637. *Cleome iberica*, DC.

On dry stony hot soil near Shálizán; June.

7. RESEDACEÆ.

359. *Reseda luteola*, L.

Shálizán, stony ground, not uncommon; May to July.

8. VIOLACEÆ.

729. *Viola biflora*, L.

The yellow violet, common on all the hills above 10,000 feet, from Serátigah to the hills opposite Kuram; July to August.

0. *V.* sp. = 16 Kashmir collection, 1877.73, 166. *V. Patrini*, DC.

Very common, sweetly scented, from 6000 to 8000 feet, Kuram to Alikhél.

89, 155. *V. serpens*, Wall.

Common in April at low elevations.

500, 119. *Viola* sp.

This is a very marked species whilst growing, at once recognizable, both from the locality where it grows in the shade of fir forests, and the distinct markings of its veins on the leaves.

9. POLYGALEÆ.

249. *Polygala abyssinica*, *Fres.*

Common in damp localities, Kuram, Kaiwás, and Shálizán; April to July.

192. *P. Hohenackeriana*, *Fisch.*

Not common, stony ground, Habíbkalla.

284. *P. sibirica*, *L.*

Damp soil along watercourses and near spring-heads at Shálizán; May.

10. CARYOPHYLLÆ.

0. *Dianthus fimbriatus*, *Bieb.*

At Sergal, stony ground; August.

0. *D. crinitus*, *Sm.*

Near Shálizán; July 12th.

638. *D.* sp.

Alikhél; July 22nd.

938. *D.* sp.

Síkarám; August 7th.

0. *D.* sp.

Shálizán; June 23rd.

856. *D.* sp.

Zabardastkalla; July 15th.

225. *Gypsophila Stewartii*, *Thoms.*

A spinous-leaved densely tufted herb, occurring in small hummocks profusely all over the country from Kuram to Alikhél and Serátígah, covered, in May, with a mass of small flowers; very attractive when first seen.

148. *G. floribunda*, *Boiss.*, var. β =1643, *Griffith.*

225 a. *G.* sp.

Probably a different species from the last; the flowers and leaves much larger, and the inflorescence laxer. Síkarám and Serátígah, above 10,000 feet; July and August.

531. *G. alsinoides*, *Bunge*, = *Stocks*, no. 970.

Alikhél; June.

961. *Gypsophila*, sp. near *G. sedifolia*, Kurz.

Flowers white with pink veins; at 14,000 feet, Sikarám; August.

526. *Saponaria Griffithii*, Boiss.

A semiprostrate perennial with large roots that are collected and employed in lieu of soap, called "*Zannah*." It is one of the few herbs that grow under pine-trees; June to August.

278. *S. Vaccaria*, L.

Common weed amongst corn, Kuram and Shálizán; May and June.

544. *Silene inflata*, Sm.

Common in woods from 8000 to 10,000 feet, Karchátal, Ali-khél, Bíánkhél; June.

144. *S. conoidea*, L.

A field-weed, profuse; April to June.

0. *S. Moorcroftiana*, Wall.

Sikarám, 10,000 feet and above; August 7th.

433. *S.* sp. = *Griffith*, no. 1640 (see *Lychnis cabulica*, Boiss.).

Petals lemon-yellow, with a very viscid reddish-brown calyx; Shéndtoi; June 31st.

473. *S.* sp.

Very common from the base of the Péwarkotal to Alikhél; June.

0. *Lychnis* sp. near *L. macrorhiza*, Royle.

My specimens have three styles; Sikarám, 11,000 feet; August.

0. *L. indica*, Benth., var. *fimbriata*.

Shéndtoi; July and August.

372. *Cerastium vulgatum*, L., var.

Shéndtoi, not common amongst débris, dry locality; June 21st.

205. *C. dichotomum*, L.

In localities common at Habibkalla and Shálizán.

0. *Stellaria crispata*, Wall.

Shéndtoi; July 8th.

214. *S. media*, L.

A weed, everywhere in fields, road-sides, wet ditches from Thal to Alikhél; April to August.

793. *S. Webbiana*, Wall.

From 11,000 to 14,000 feet amongst dwarf juniper; July.

555. *Stellaria* sp.

With great massive rootstocks ; Hariáb district in pine-forests, not uncommon. June to August.

404. *S. bulbosa*, *Wulf.*

Shéndtoi, in the forest at 11,000 feet ; June.

269. *Arenaria Meyeri*, *Boiss.*

A stiff, erect, harsh annual, on dry stony country, occasional ; May.

495. *A. foliosa*, *Royle.*

In great masses at the base of Síkarám, 11,000 feet ; June.

0. *A. Griffithii*, *Boiss. ?*

Specimens without fruit, at 11,000 feet, Karchátal ravine ; June.

300. *A. serpyllifolia*, *L.*

Common form, Shálizán.

584. Variety of the same from Karchátal ; June.

378. Variety from Shéndtoi.

477. *A.* sp.

On a woody rootstock, in dry clay soil, near Zabardastkalla.

11. PORTULACÆE.

902. *Portulaca oleracea*, *L.*

Common near damp soil, Shéndtoi ; July.

12. TAMARISCINÆE.

Tamarix sp.

A small tree or large shrub, common along the banks of the Kuram river from Thal to Walli Mahomed-Kalla. No specimen was collected.

252. *Myricaria germanica*, *Desv. ?*

Along the streams that lead into the Kuram river, near the Fort of Kuram ; April.

13. HYPERICINÆE.

627. *Hypericum perforatum*, *L.*

Shálizán and Shéndtoi, very common ; June and July.

944. *H. scabrum*, *L.*

Síkarám, 10,000 feet, on dry shingle ; August.

65. *H.* sp.

A small shrub with medium-sized flowers, hanging from cliffs near Kuram ; April.

613. *H.* sp. ?

14. MALVACEÆ.

635. *Althæa rosea*, Cav.

Occasional on stony ground, but in some localities, as in the vicinity of the Pêwârkotal, profuse; seems quite wild, but it is cultivated upon graves and near Fakirs' huts. Rose-coloured and white; June.

693. *A. officinalis*, L.? = Griffith, no. 1273.

A very common tall shrub in the vicinity of cultivation, often forming parts of natural hedges that occur between fields. Shâlizân and Kuram; June and July.

208. *Malva rotundifolia*, L.

Everywhere amongst stones, from 5000 to 7000 feet.

840. *Hibiscus Trionum*, L.

In fields, profuse, from Kuram to Alikhél; July and August.

15. LINÆÆ.

959, 525. *Linum perenne*, L.

On dry stony soil, common from Kuram to Alikhél, and up to 14,000 feet on the hills; May to August.

16. GERANIACEÆ.

761. *Geranium Wallichianum*, Sweet.

Large bluish flowers. Amongst bushes and grass and boulders where there is moisture, from 8000 to 10,000 feet. The rhizomes of this plant were brought to me (said to be from some hills thirty miles off) as "Mam-í-ran," a good medicine for sore eyes. This, no doubt, is a local substitute for the true Mam-í-ran, viz. the roots of *Coptis Teeta*, Wall.

281, 220. *G. nepalense*, Sweet.

On open grassy spots, very common; May and June.

600, 868. *G.* sp.

Grassy spots, near springs, local about Bíánkhél; July.

836. *G.* sp. (White var. of 600.)143, 90. *Erodium cicutarium*, L.

Very common, Kuram to Habíbkalla; May to June.

909. *Oxalis corniculata*, L.

Everywhere from Thal to Habíbkalla; flowers five months.

1005. *Impatiens amphorata*, Edgw.

From 9000 to 10,000 feet in very moist localities; flowers rose-pink and yellow; Shéndtoi; August.

587. *Impatiens* sp. = 1251 and 1252, *Griffith*.

Very common amongst the shingly beds of streams at 7000 feet; June.

653. *I.* sp. near *I. racemosa*, *Wall.*

Small, white, minute flowers. Very common with 587 in streambeds; June and July.

17. BUTACEÆ.

838. *Ruta acutifolia*, *DC.*

Local at Alikhél in cultivated fields, 7500 feet; July. Leaves vertical.

636. *Peganum Harmala*, *L.*

In certain localities very common, but very local. Remarkably frequent on graves. Shálizán; June.

18. MELIACEÆ.

334. *Melia Azedarach*, *L.*

A small tree; usually cultivated in sacred localities; not seen further west than Túrai. An occasional escape along footpaths. Called "Daráchk."

19. CELASTRINEÆ.

375. *Euonymus fimbriatus*, *Wall.*

A small tree, common in the deep gorges of Kaiwás and Shéndtoi, from 8000 to 10,000 feet; occasional in the hills to the north of the Hariáb district, usually near water.

20. RHAMNEÆ.

650. *Zizyphus vulgaris*, *Lamk.*

At Shálizán a small shrub struggling for existence, and most probably introduced for hedges, for which it is now employed; not uncommon near the river between Thal and Kuram.

337. *Berchemia lineata*, *DC.*

A small shrub, very much browsed by cattle; common at 7000 to 8000 feet; Shálizán, Kaiwás, and to the east. The fruit is collected largely and eaten by the people; it is called "Mahmannah," the name applied round Peshawur to the fruit of species of *Sageretia*.

357. *Rhamnus persicus*, *Boiss.*

A common shrub from Thal up to hot hill-sides near Shálizán.

O. R. sp., flowers only = 357?

703. *Rhamnus dahuricus*, *Pall.*

A small tree, amongst thick undergrowth near moisture, from 7000 to 8000 feet; not uncommon in the woods near Shalizán, Shéndtoi, Kaiwás, but not further west; fruit employed as a purgative by the natives.

379. *R. purpureus*, *Edgew.*

A common tree-shrub near Shéndtoi and Shálizán.

915. *R. sp.*=No. 7, *Strachey & Winterbotham.*

Síkarám, 10,000 to 11,000 feet; August.

759. *Sageretia*, *sp.*

Specimens poor, and all collected from one small browsed bush. Apparently new. Near Shálizán.

21. AMPELIDÆ.

Vitis vinifera, *L.*

A large scandent vine is grown in all the orchards, and allowed to climb over the largest trees; there are two varieties of fruit, a white and a purple. Only in one garden did I see small bushes of a variety trained as standards from 3 to 4 feet high; this yielded a small green seedless grape. From the Logan valley and the vicinity of Cabul grapes were brought in large quantities across the passes for sale amongst the troops; some were very fine in quality. Along with the grapes, plums, apples, and a few pears were also brought.

22. SAPINDACEÆ.

853. *Acer sp.* near *A. campestre*, *L.*

A small tree, collected only in the valleys on the Hazárdarakht river in July and August, and not in fruit. The natives described a similar tree with much larger leaves as occurring in the vicinity.

Dodonæa viscosa, *L.*

Occurs in some quantity to the south or right bank of the Kuram river, on the hills opposite the Fort of Kuram, and at the Darwazaghai pass, where I saw it. It is common from Thal to near Kuram on both banks of the river, but it does not extend west of Kuram in this locality. (No specimens.)

400, 396. *Staphylea Emodi*, *Wall.*

A large shrub, collected only in some of the deep gorges of the Shéndtoi ravine, from 8000 to 9000 feet; June and July.

23. ANACARDIACEÆ.

233, 342. *Rhus Cotinus*, *L.*

A large shrub, common on the lower hills at Shálizán, from 7000 to 8000 feet; April.

38, 234. *Pistacia integerrima*, *Stewart.*

On the lower hills near Shálizán, not common; April. Common between Thal and Kuram near the river, but only as individual trees.

17, 361. *P. cabulica*, *Stocks.*

An occasional tree from Thal to Shálizán, usually not large. At Shálizán there was a quite sound tree 30 feet high, and 9 feet in circumference at 4 feet from the ground; at 6 feet the trunk divided into large branches.

528. *P. sp.*

A large woody bush in a forest of *Juniperus excelsa* near Biánkhél, at 8500 feet; June.

24. LEGUMINOSÆ.

682. *Ononis arvensis*, *L.*, var. *spinosa.*

Shálizán and Biánkhél, at 6500 to 8000 feet, in moist meadowland and sides of streams, common; June and July.

468. *Trifolium resupinatum*, *L.*

Largely cultivated, both near Kuram as well as in the Hariáb district. Curiously enough, the Kuram people all depend upon the higher district near Sergal and Ballút, and not to their own crops, for their seed. Called "Shantal."

152. *T. pratense*, *L.*

Common everywhere in dampish localities. Not cultivated.

19. *T. repens*, *L.*

Forming a portion of all pasturage near moisture from Alizai to Alikhél. Not cultivated.

1212. *T. fragiferum*, *L.*

Occasional with *T. repens* at Shálizán.

482, 875. *Trigonella polycerata*, *L.*

Common near Zabardastkalla; June and July.

712. *T. pubescens*, *Edgew.*

Not common, Kaiwás.

193, 236. *T. Emodi*, *Benth.*

Common from Kuram to Alikhél; April to July.

795. *Trigonella corniculata*, *L.*

Common; July.

681. *Melilotus alba*, *L.*

Shálizán.

699. *M. officinalis*, *Willd.*

Very common in cultivated ground and fields from Kuram to Alikhél; June and July.

31, 665. *M. lupulina*, *L.*

Shinnak, Kuram, and Shálizán, common; April to June.

355. *M. sativa*, *L.*

A very common field-weed. Not cultivated now, nor could any one tell me if it was formerly. It is certainly cultivated in the Punjab, where it is also a weed. Common from Shálizán to Ali-khél; May and June.

2, 137, 649, 610. *Lotus corniculatus*, *L.*

Very common in moist meadows and on sides of watercourses from Thal to Alikhél; April to June.

340, 630. *Indigofera Gerardiana*, *Wall.*

A dense shrub up to 4 feet, profuse around Shálizán, forming natural hedges around the fields by growing densely along the sides of the watercourses that divide them; also from Kuram to 7000 feet in the watercourses and low moist thickets; not in the Hariáb district.

511. *Colutea arborescens*, *L.*

A tall thin shrub, met with in the Hariáb district only, where it is very common, and remarkable both for its inflorescence and for the large inflated pods, which give it its local name, meaning "bellows;" June and July.

286. *Caragana brevispina*, *Royle.*

On dry hills, amongst scattered scrub, at 7000 feet, around Shálizán; May.

549, 1220. *C. ambigua*, *Stocks.*

A large shrub, in size of wood and appearance of bark very like laburnum. Bark employed by the Afghans in the form of rings to slip over and hold the sheaths of their long knives in position in lieu of brass-work; the surface takes a good polish, and when new resembles bronzed leather. The wood is called "Jirrél." Alikhél, Káratígah, and the hills north of Hariáb district at 9000 to 11,000 feet. From native accounts there is none of it east of Spingháo. Baker thinks *C. ulicina*, *ambigua*, and *brevispina* may be three varieties of one species. I am of the same opinion.

835. *Caragana grandiflora*, *Bieb.*

A large shrub, Káratígah ; July.

8. *C. ulicina*, *Stocks?*

This very distinct shrub, which much resembles a dwarf *Acacia modesta*, is only from 2 to 3 feet in height. I first mistook it for *Acacia modesta* dwarfed by climate. Very common from Ibrahimzai, along the road up the right bank of the Kuram river, to the Dar-wazaghai pass ; not uncommon from Alizai to Badishkhél. It is a low country, from 4000 to 7000 feet.

1219. *C. arborescens*, *Lamk.*

Biánkhél and along the Léliddar stream.

1218. *C. (Chesneya) acaulis*, *Baker*, n. sp. *Herba* perennis, acaulis, rhizomate lignoso gracili elongato. *Folia* rosulata, imparipinnata, facie parce dorso dense persistenter albo-sericea, foliolis 7-9 obovato-cuneatis sessilibus 4-8 lin. longis apice obtusis vel truncatis minute cuspidatis, rachi subpollicari, petiolo brevi, stipulis parvis lanceolatis albo-sericeis. *Pedunculus* fructiferus 12-15 lin. longus. *Calyx* 6-9 lin. longus, tenuiter albo-canescens, tubo cylindrico, dentibus lanceolatis tubo duplo brevioribus. *Corolla* pollicaris, vexillo 6 lin. lato extus sericeo sordide purpurascens intus luteo, alis vexillo paulo brevioribus, carina obtusa alis paulo brevioribus. *Legumen* lineare, 2-2½ poll. longum, leviter recurvatum, rigidum, mucronatum, tenuiter canescens, seminibus circiter 20 reniformibus compressis.

Allied to *C. cuneata*, *Baker*, in 'Flora of British India,' vol. ii. p. 117, from which it differs by its fewer leaflets and solitary flowers. It has a dense fibrous rootstock much out of proportion to the few leaves and solitary pedunculate flowers, not more than 2 or 3 inches at the most in length. The interior of each flower is golden yellow, the exterior a dead grey-purple. On dry hot hill-sides, Shálizán and Habíbkalla ; April and May.

42. *Astragalus anfractuosus*, *Bunge.*

Shinnak, Sadatkalla, and Kuram ; April.

586. *A. coluteocarpus*, *Boiss.*

In the pine-forest up the Karchátal ravine, at about 9000 feet ; June.

174, 76. *A. decemjugus*, *Bunge.*

Profuse in the fan country near Habíbkalla on shingle ; May.

241. *A. graveolens*, *Ham.*

Very common near watercourses. Kuram and Shálizán ; April to June.

80, 61, 52, 184, 53. *A. hippocrepidis*, *Benth.*

Very profuse from Kuram to Habíbkalla ; April and May.

1213. *Astragalus infestus*, Boiss.

Bíánkhél; July.

916, 435. *A. leucocephalus*, Grah.

Among débris, Síkarám, 12,000 feet, Péwárkotal, 8500 feet, between Shálizán and Habíbka, 6500 feet.

1216. *A. murinus*, Boiss. ?

Habíbka to Péwárkotal.

23. *A. polyacanthus*, Royle.

Shinnak; April. (A Punjab Salt-range plant.)

485, 451. *A. psilacanthus*, Boiss.

Common from Kuram to Zabardastka and Síkarám; April to July.

436, 81. *A. purpurascens*, Bunge.

From Habíbka to Síkarám at 15,000 feet; April to August.

1214. *A. raphiodontus*, Boiss.

Zabardastka; July.

441, 237. *A. rhizanthus*, Royle.

Abundant in pine-forests at Péwárkotal; May and June.

434. *A. strobiliferus*, Royle.

Shálizán to Habíbka.

502. *A. tephrosioides*, Boiss.

West base of Síkarám. A tall (3 feet) herbaceous stem from a thick perennial rootstock. Only one plant of this collected with several stems from the rootstock. June.

421. *A. verticillaris*, Bunge.

From 6000 to 8000 feet; profuse in pine-forests on Péwárkotal along with 441. The verticillate leaves give the plant a very ru-biaceous look.

924. *A. (Hypoglottis) immersus*, Baker, n. sp. *Herba* perennis, dense cæspitosa, rhizomate valde ramoso. *Folia* imparipinnata, pallide viridia, dense albo-hispida, foliolis 13-15 oblongo-lanceolatis acutis 1-2 lin. longis, rachis 3-6 lin. longa, petiolo brevi, stipulis lanceolatis. *Pedunculus* interdum pollicaris. *Racemi* subumbellati, 3-4-flori, pedicellis brevissimis, bracteis minutis subulatis. *Calyx* 1½ lin. longus atro-viridis, pilis albidis paucis adpressis vestitus, tubo infundibulari, dentibus parvis lanceolatis. *Corolla* cærulea, calyce duplo longior, alis vexillo paulo brevioribus. *Legumen* oblongum, turgidum, acutum, 3 lin. longum, distincte stipitatum, tenuiter albo-canescens, sutura nullo modo inflexa, seminibus 3-4 parvis reniformibus duplo longioribus quam latis.

A near ally of *A. confertus*, Benth., of West Tibet. From 12,000 to 14,000 feet, Síkarám; a very minute plant; August.

818, 1004. *Astragalus (Phaca) microdontus*, Baker, n. sp. *Herba* perennis, caulibus elongatis ramosis tenuiter adpresse albo-pubescentibus. *Folia* viridia tenuissime pubescentia, foliolis 11-21 lineari-oblongis vel oblongis obtusis 6-12 lin. longis distincte petiolulatis, rachi 2-4-pollicari, petiolo brevi, stipulis parvis linearibus. *Racemi* densi 2-3 poll. longi, sæpe secundi, pedicellis 1-1½ lin. longis, bracteis magnis membranaceis oblongo-lanceolatis cito deciduis. *Calyx* viridis, subglaber, 2 lin. longus, tubo oblongo, ore obliquo subintegro ciliato. *Corolla* primum pallide lutea, demum purpurascens, calyce duplo longior. *Legumen* glabrum, lineare, compressum, 5-6 lin. longum, 1½-2 lin. latum, ad apicem et basin angustatum, perfecte biloculare, stipite calyce longiore, seminibus 6-8.

Closely allied to the West-Himalayan *A. chlorostachys*, Lindl. Remarkable for the almost complete suppression of its calyx-teeth. Shéndtoi, 7000 to 10,000 feet.

238, 710. *A. (Hypoglottis) Kuramensis*, Baker, n. sp. *Herba* perennis, caulibus elongatis pilis mollibus patentibus albidis tenuibus vestitis. *Folia* viridia, facie glabra, dorso et margine tenuiter laxe pilosa, foliolis 21-31 oblongis obtusis distincte petiolulatis 6-9 lin. longis, rachi interdum semipedali, petiolulis brevissimis, stipulis magnis connatis membranaceis persistentibus. *Racemi* multi, densi, sessiles, axillares, 1½-2 poll. longi, pedicellis brevissimis, bracteis lanceolatis. *Calyx* viridis, demum brunnescens, 5-6 lin. longus, tenuiter laxe pilosus, dentibus linearibus tubo æquilongis. *Corolla* lutea, calyce paulo longior. *Ovarium* distincte stipitatum, dense albo-sericeum, ovulis pluribus. *Legumen* ignotum.

A neighbour of *A. cashmirensis*, Bunge, and *A. Munroi*, Benth. Kuram, April; also at 10,000 feet, July.

488, 510. *A. (Hypoglottis) rhizocephalus*, Baker, n. sp. *Herba* perennis, acaulis, dense albo-pilosa. *Folia* pallide viridia, pilis multis patentibus albis molli bus tenuibus vestita, foliolis 25-31 obovatis obtusis vel emarginatis 3-4 lin. longis breviter petiolulatis, rachi 2-3-pollicari, petiolo subpollicari, stipulis magnis membranaceis. *Flores* numerosi, in capitem globosum sessilem aggregati, pedicellis brevissimis, bracteis linearibus. *Calyx* 6-7 lin. longus, densissime albo-pubescentis, dentibus lineari-subulatis tubo æquilongis. *Corolla* lutea, calyce paulo longior. *Ovarium* stipitatum, dense albo-sericeum, ovulis pluribus. *Legumen* haud visum.

Near *A. erionotus*, Benth., Bunge, No. 187. Sergal to Biánkhél and Sîkarám; May and June. In pine-forests, Biánkhél.

75. *A. sp.* near *A. auganus*, Benth.

Habîbkalla; March.

1215. *A. sp.* near *A. horridus*, Boiss.

Sergal to Biánkhél.

167. *Astragalus Susianus*, Boiss., var.

Kuram and Habíb-kalla, most profuse; corolla lovely bright pink. Very characteristic on the dry gravel soil of the fan country.

A. (Calycophysa) ptilocephalus, Baker, n. sp. Fruticulosus, nanus, ramosissimus, foliorum delapsorum rachibus pungentibus persistentibus armatus. *Folia* condensata, pallide viridia, pilis albis adpressis tenuiter canescentia, foliolis 8-10 lanceolatis acutis rigidulis complicatis subsessilibus erecto-patentibus 3-4 lin. longis, rachi subpollicari pungente, petiolo brevi, stipulis latis membranaceis petiolo longe adnatis. *Flores* multi, radicales, dense capitati, pedicellis subnullis, bracteis parvis membranaceis lanceolatis vel linearibus. *Calyx* semipollicaris, densissime albo pilosus, basi antice rotundatus, dentibus subulatis plumosis tubo duplo longioribus. *Corolla* lutea vel vetustate purpureo tincta, calyce vix longior. *Ovarium* sessile, dense pilosum, ovulis paucis. *Legumen* ignotum.

Allied to *A. Susianus*, Boiss. Same locality as above; flowers lemon-yellow.

109, 191, 476, 556. **A. (Cercidothrix) cerasinus**, Baker, n. sp.

Herba perennis, acaulis, inermis, dense cæspitosa. *Folia* pallide viridia, pilis hispidis adpressis albis brevibus dense canescentia, foliolis 13-19 subsessilibus orbicularibus vel obovatis 2-4 lin. longis minute cuspidatis, rachi 1-2-pollicari, petiolo elongato, stipulis parvis lanceolatis. *Pedunculus* $\frac{1}{2}$ -2-pollicaris, albo-canescens. *Racemi* pauciflori, pedicellis brevissimis, bracteis parvis deltoideis persistentibus. *Calyx* 4 lin. longus, tubo cylindrico atro-viridi pilis brevibus adpressis dense canescente, dentibus parvis linearibus. *Corolla* luteo-cerasina, calyce duplo longior. *Legumen* cylindricum, sessile, 9-10 lin. longum, obscure albo-hispidum, perfecte biloculare, 7-8-spermum.

Closely allied to the European *A. incanus*, L. Zabardastkalla and Alikhél; April to June.

482. **A. (Hypoglottis) luteo-cæruleus**, Baker, n. sp. *Herba* perennis, acaulis, inermis, dense cæspitosa. *Folia* pallide viridia, utrinque pilis albis multis hispidis adpressis vestita, foliolis 26-29 oblongo-lanceolatis subsessilibus 2-6 lin. longis, rachi 1-2 $\frac{1}{2}$ -pollicari, petiolo 6-12 lin. longo, stipulis lanceolatis. *Pedunculus* gracilis, 2-5-pollicaris, pilis adpressis albis vestitus. *Racemi* capitati, 6-12-flori, pedicellis brevissimis, bracteis parvis foliaceis lanceolatis persistentibus. *Calyx* 4-5 lin. longus, pilis multis elongatis albidis et nigris ascendentibus vestitus, dentibus linearibus tubo æquilongis. *Corolla* luteo-cærulea, 6-7 lin. longa. *Legumen* oblongum, turgidum, stipitatum, 4-5 lin. longum, puberulum, sutura ventrali introflexa, seminibus 8-10.

Allied to the European *A. depressus*, L. West base of Síkarám; June.

54. *Ebenus stellata*, Boiss.

A large shrub, covered with enormous harsh-looking spines, that prove quite pliant to the touch, and very silky leaves giving it the general appearance of a *Hippophaë*. Common from Badish-khél to Sadatkalla, and thence in occasional patches to near Shálikán cantonments.

240. *Glycyrrhiza glandulifera*, Wald. & Kit.

Kuram; April.

489. *Onobrychis cornuta*, Desv.

From Sergal to the west base of Sikarám, about 9000 to 11,000 feet; June. Forms immense hedgehog-like, intensely matted gregarious masses, perfectly rounded, as if clipped. Flowers white or purple.

68, 86, 186. *O. (Hymenobrychis) dasycephala*, Baker, n. sp. *Herba* acaulis, perennis, radice elongata lignosa. *Folia* rosulata, imparipinnata, utrinque dense persistenter albo-sericea, foliolis 9-11 sessilibus, 3-4 lin. longis oblongis vel obovatis obtusis vel subacutis, rachi subpollicari, petiolo subpollicari, stipulis linearibus. *Pedunculus* 2-3-pollicaris, albo-canescens. *Racemus* dense 20-30-florus, bracteis lanceolatis, pedicellis brevissimis. *Calyx* 4-5 lin. longus, dense molliter albo-sericeus, tubo campanulato, dentibus lineari-subulatis tubo multo longioribus. *Corolla* 6-7 lin. longa, vexillo obovato 5-6 lin. lato luteo lineis rubris percurso, alis parvis luteis, carina lata vexillo æquilonga. *Legumen* lanosum, oblongo-reniforme, dispermium, 6-7 lin. longum, faciebus alveolatis breviter spinosis, margine angusto corneo dentibus multis inæqualibus lanceolatis acuminatis $\frac{1}{2}$ -1 lin. longis armato.

Allied to *O. dealbata*, Stocks. Very profuse on stony ground in the fan country, Kuram to Habíbkalla; April and May.

51, 85, 263. *O. (Hymenobrychis) microptera*, Baker, n. sp. *Herba* perennis, acaulis vel breviter caulescens. *Folia* imparipinnata, breviter albo-hirsuta, foliolis 13-15 oblongis acutis 3-4 lin. longis breviter petiolulatis, rachi $1\frac{1}{2}$ -2 poll. longa, petiolo elongato, stipulis lanceolatis. *Pedunculus* 1-3-pollicaris. *Racemus* floriferus subluxus, $1\frac{1}{2}$ -2 poll. longus, fructiferus 3-4-pollicaris, pedicellis brevibus, bracteis parvis linearibus. *Calyx* $1\frac{1}{2}$ lin. longus, pubescens, tubo campanulato, dentibus linearibus tubo longioribus. *Corolla* 3-4 lin. longa, albida, lineis rubellis decorata, vexillo obovato fauce lutea, alis parvis lanceolatis, carina obtusa vexillo æquilonga. *Legumen* orbiculari-reniforme, mono-spermium, tenuiter albo-araneosum, 4 lin. longum, faciebus profunde alveolatis haud spiniferis, margine angusto albido membranaceo erosodenticulato.

This should be placed between species 47 and 48 in Bois-

sier's 'Flora Orientalis.' Badishkhél to Habíbkalla, all the fan country, profuse; April.

168. *Onobrychis* sp.

Habíbkalla; April.

512, 484. *O.* sp. near *O. heterophylla*, C. A. Mey.

Profuse in the Hariáb district, dry stony soil, Sergal, Zabardastkalla, Bíánkhél; June.

1217. *O. (Dendronobrychis) spinosissima*, Baker, n. sp. Nana, fruticosa. *Folia* rosulata, basi petiolis rachibusque vetustis spinescentibus erecto-patentibus dense cincta æqualiter pinnata, pallide viridia, albocanescentia, foliolis oblongis 5-6-jugis 1½-2 lin. longis, rachi vix pollicari stricta apice pungente, petiolo brevi, stipulis parvis lanceolatis membranaceis. *Racemi* 1-3-flori, pedunculi radicali brevissimi, pedicellis subnullis. *Calyx* 1 lin. longus, pubescens, tubo campanulato, dentibus deltoideo-cuspidatis tubo longioribus. *Corolla* rubello-purpurea, 4-5 lin. longa. *Legumen* dimidiato-orbiculare, monospermum, 4 lin. longum, faciebus areolatis, margine exalato.

Allied to the Persian *O. arnacantha*, Bunge. From 9500 to 12,000 feet on Sikarám; forms dense masses, but not nearly so firm or so hedgehog-like as 489.

661. *Lespedeza sericea*, Miq.

In stony places from 6000 to 7000 feet, Shálizán, common; June.

786. *Hedysarum astragaloides*, Benth.

Shéndtoi at 10,000 feet; flowers pink; July.

810. *Desmodium tiliaefolium*, G. Don.

Amongst the low scrub, altitude 7000 feet, near Shálizán and Shéndtoi, not very common; July.

740. *Cicer soongaricum*, Steph.

Kaiwás, at 10,000 feet, profuse near forest; July.

819. *C. soongaricum*, Steph., var. *spinosum*.

Serátigah, at 11,000 feet; July.

3, 714, 591. *Vicia sativa*, L.

A very common weed in corn-fields, Mandúrí, Kaiwás, and Kar-chátal, at 3000 to 9000 feet.

188, 554, 506, 580. *Ervum Ervilia*, L.

Cultivated throughout the Hariáb district extensively, and a little near Habíbkalla; is frequently an escape.

294. *Lathyrus Aphaca*, L.

Profuse as a field-weed from Kohat to Káratígah; May and June.

581. *L. sphæricus*, Retz.

A field-weed; very common at Karchátal.

691, 910, 666. *Glycine Soja*, Sieb. & Zucc.

Largely cultivated in the Kuram district, occasionally in Hariáb, also frequent as a weed in cultivated ground; June.

973. *Phaseolus vulgaris*, L.

Cultivated as a field-crop near Rokian; August.

566. *Sophora* (Goebelia) *alopecuroides*, L.

Only collected at one locality near Alikhél, on dry stony clay-soil at 7200 feet, and there it was profuse; June and July.

93. *S.* (*Edwardsia*) *mollis*, Royle.

From Kohat, Thal, and Kuram, through the Hariáb district to Káratígah, profuse, from 2000 to nearly 10,000 feet, in pine-forests.

25. ROSACEÆ.

419. *Prunus Amygdalus*, Baill.

A small tree, occurring in gregarious patches in certain localities from near the Shéndtoi ravine to Káratígah. Said to be quite common by the natives, and well known to them; called by the same native name as the cultivated almond, "*Bédám*." The fruit is not eaten. The stems are employed as rods to carry in the hand by the priests, but are not used as we do walking-sticks; they are considered more or less holy. In orchards a tree or two of the almond may exist; but I never saw it, nor is it cultivated, to my knowledge, in the Kuram valley.

852. *P.* sp. near *P. Amygdalus*, Baill.

The form of the fruit is quite different from that of 419, being longer and more flat. The surface of the fruit resembles that of the peach in texture and colour; and the nut is quite distinct from that of 419. The whole shrub resembles more what one might consider a wild form of the peach than that of the almond. Collected only in the Hazárdarakht ravine, fruiting in July.

108. *P. eburnea*, Spach? = *Griffith*, no. 1212.

A small stiff scraggy shrub which covers the whole of the open stony ground from Zabardastkalla to Alikhél; particularly characteristic of the country. Flowers in April, before the leaves. The profusion of rose-pink flowers on the light-grey stems of

what is then a leafless shrub gives a brilliant colouring to the bare stony country upon which it grows.

***Prunus persica*, Benth. & Hook. f.**

Is sparingly cultivated in the Shálizán orchards in both forms, peach and nectarine.

***P. armeniaca*, L.**

The apricot is cultivated largely in orchards up to 9000 feet. There are several forms of the fruit.

700. *P. Cerasus*, L.

The cherry. A few trees exist in the Kuram valley; I have seen two small ones at Shálizán, and I have been informed of others existing in other villages.

387, 317. ***P. Jacquemontii*, Hook. f. in Fl. Brit. Ind. ii. p. 314.** *Flores rosei, foliis coætanei, solitarii, brevissime pedunculati, 8-10 lineas diametro; calycis tubus cylindricus, 3-4 lineas longus, extus glaber, intus parce pilosulus; lobi oblongi, rotundati, lineam longi, extus glabri, intus albo-pilosi; petala oblongo-elliptica, apice rotundata, 3-4 lineas longa, basi supra calycem glandula lineata notata; stamina 25-, 30 petalis duplo triplove breviora; ovarium glabrum; stylus exsertus.*

An extremely common shrub from Shálizán to Alikhél. When the fruit is ripe and the bush is covered with it, which is usually the case, it forms a very pretty object in the landscape. It would be worth cultivating for ornamental purposes.

702. *P. communis*, Huds., var.

The cultivated plum. The specimens were collected from trees near Kaiwás in July, that may be escapes; but apparently this tree seems to spread through the woods in the lower hills at from 7000 to 9000 feet very easily. About 20 feet high, 4 feet girth. Fruit yellow or red, resembling poorer specimens of garden fruit.

807. *P. communis*, Huds., var.

A cultivated plum, round and flattened at the ends, like a large greengage, but slightly purplish in colour and very watery when ripe; not fleshy, and having an extremely thin skin that completely separates from the pulp. Shéndtoi, in an old orchard, 7000 feet. Both the above plums are grown in the orchards of all the large villages of the Kuram valley, but less so in those of the Hariáb district.

387. *P. Padus*, L.

A small tree, not very common from 7500 to 9000 feet in the

Shéndtoi and Gandháo villages. It is well known to the natives for its fruit, and, curiously enough, is called by a name very similar to that in use in Kashmir, from the likeness of the hanging fruit to a small bunch of grapes, "Angúrak."

674. *Spiræa vestita*, Wall.

Common near running streams, Shálizán; June.

674a. *S. vestita*, Wall., forma depauperata.

Collected in the Spíngháó ravine; July.

386. *S. scorbifolia*, L.

Profuse in water-channels in the hills from 7000 to 9000 feet.

540, 331, 232. *S. brahuica*, Boiss.

Very common in Kuram, Alikhél, and Shálizán.

804, 422. *Rubus niveus*, Wall., var. *Aitchisoni*, Hook. fil.

A fine rasp-like shrub, common at the upper limit of trees, growing amongst low shrubs and large boulders, and having an orange-red fruit as large as the fruit of the ordinary brambles, which is fleshy and good to eat. Shéndtoi ravine; July.

471. *R. fruticosus*, L., var.

Common in the vicinity of Shálizán in natural hedges around the fields and sides of water-channels.

0. *R. fruticosus*, L., var.

At Shálizán; August.

765. *R. purpureus*, Bunge.

Not uncommon around fields, from 8000 to 9000 feet; July.

696. *R. lasiocarpus*, Sm.

Shálizán; June.

422. *R. leucanthus*, L.?

At Shálizán; May.

762. *Geum urbanum*, L.

Occasional at from 7000 to 8000 feet, near water, Shálizán; July.

282. *Fragaria indica*, Andr.

Common on stony ground, road-sides, and at foot of walls, Shálizán.

224. *F. vesca*, L.

Very common from Kuram to Alikhél up to 10,000 feet.

747. *Potentilla Sibbaldi*, Haller.

On the hills, generally at 10,000 feet, on open stony ground profuse; June and July.

728. *Potentilla* (§ *Fragariastrum*) *Collettiana*, *Aitchison et Hemsley*, n. sp. Nana, cæpitosa, foliis confertis trifoliolatis omnino argenteo-sericeis, foliolis obovato-oblongis apice truncatis et tridentatis basi cuneatis, pedunculis brevibus 1-4-floris, floribus parvis aureis, receptaculo achæniisque sericeo-hirsutis.

Herba perennis, cæspitosa, nana, tota adpresse sericeo-argentea, caudice crasso elongato, pedunculis vel caulibus floriferis gracilibus, 1-3-pollicularibus, paucibracteatis, 1-4-floris. *Folia* densissime conferta, petiolata, trifoliolata; foliola sessilia, obovato-oblonga; 6-9 lineas longa, basi cuneata, apice truncata tridentata; petiolus usque ad sesquipollicaris; stipulæ angustæ, petiolo longæ adnatæ, parte libera brevi lineari acuta. *Flores* aurei, 6-8 lineas diametro, longiuscule pedicellati; calycis lacinia 10, ovato-oblongæ, vix acutæ, alternæ paullo breviores; petala elliptica, utrinque rotundata, 2½-3 lineas longa, lacinii calycis paullo longiora; discus carnosus, annularis, breviter lobatus; stamina circiter 20, petalis dimidio breviora; filamenta glabra; receptaculum hirsutum. *Achænia* circiter 15, immatura undique longe hirsuta.

Allied to *P. curviseta*, Hook. f., and *P. libanotica*, Boiss. Forms a woody rootstock, with large, extremely silky, slightly 3-toothed leaves. Growing from the face of overhanging rocks at an elevation of 10,000 to 11,000 feet, forming a very handsome rock-plant with its masses of yellow flowers. Sîkarâm and Kaiwâs.

687: *P. fragarioides*, L., var. *pumila*.

Shâlizân; June.

595. *P. fragarioides*, L., var. *Gerardiana*.

Common, Karchâtal, Kaiwâs, Shâlizân; May, June, July.

583. *P. multifida*, L.

At 11,000 feet, not common, Karchâtal; June.

967. *P. sericea*, L., var.

At 14,000 feet on the crests of the hill above the lake; August 14th.

153. *P. reptans*, L.

Common from 5000 to 7000 feet.

800. *P. argyrophylla*, Wall.

A splendid plant, collected only in one locality, just at the limit of trees, from 11,000 to 11,500 feet, springing up from amongst other low-growing shrubs. Shéndtoi; July.

954. *P. monanthes*, Lindl.

At 15,000 feet, Sîkarâm, amongst stony débris; August.

5. *P. supina*, L.

Stony localities with moisture, from Thal to Habîbkalla, profuse.

974. *Agrimonia Eupatorium*, *L.*

Common on sides of watercourses from 6000 to 7000 feet.

1211. *A. pilosa*, *Ledeb.*

Near water, sides of fields, and in hedgerows, common; Shálizán.

185. *Poterium Sanguisorba*, *L.*

Most common on the margins of watercourses near fields.

333 *Rosa damascena*, *Mill.*

In all gardens, cultivated for ornament, not for rose-water; June.

326. *R. Eglanteria*, *L.*

In hedges around gardens and at holy shrines; Bíánkhél, Shálizán; May and June.

309. *R. anserinæfolia*, *Crepin* (non *Boiss.*).

From the vicinity of Shálizán; profuse near streams, not cultivated. Briar-scented.

0. *R. anserinæfoliæ*, *Boiss.*, var. *cabulica* = *Griffith*, *Afghan*. no. 1203.

Sergal at 8500 feet, common. Indigenous.

398. *R. macrophylla*, *Lindl.*

More commonly met with in the interior of the hills, or at 8500 feet, along the Hariáb district.

343. *R. Webbiana*, *Wall.*

A small erect shrub in dry stony localities, chiefly Hariáb district, but also occasional in the fan country about Shálizán; June.

472. *R. moschata*, *Mill.*

Occurs not rarely about 7000 feet in wooded localities and in the vicinity of water, climbing over trees and covering them with a sheet of blossom; flowers in June. Is also cultivated.

04. *R. canina*, *L.*, var.

Very common in hedgerows; flowers in May.

425. *R. canina*, *L.*, var.

Shálizán; May.

165. *R. Ecæ*, *Aitchison*, *MSS.*, n. sp. Humilis, ramosissima, aculeatis-sima, aculeis in ramis floriferis homomorphis rectis rigidis basi valde dilatatis, foliis parvulis 5-9-foliolatis parce glandulosis, floribus aureis solitariis infra 1 poll. diametro, fructu globoso glabro nitido laciniis calycis reflexis coronato.

Frutex erectus, 3-4-pedalis, ramosissimus, aculeatissimus, ramis gracili-
 usculis, junioribus ruberrimis, glabris; aculeis in ramis floriferis homomor-
 phis, confertis, rectis, rigidis, basi valde dilatatis, primum ruberrimis,
 usque ad semipollicaribus. *Folia* in ramulis lateralibus brevissimis uni-
 floris conferta, 6-12 lineas longa, 5-9-foliolata, subtus præcipue parce
 glandulosa; foliola subcoriacea, ovato-oblonga obovata vel interdum
 fere rotundata, 2-3 lineas longa, serrulato-dentata; stipulæ incon-
 spicuae. *Flores* aurei, vix 1 poll. diametro, breviter pedunculati; calycis
 segmenta lanceolata, integerrima, vel apicem versus interdum pauciden-
 tata, reflexa, petala fere æquantia, extus primum glandulosa, intus albo-
 villosa; petala obovato-oblonga basi lata; achænia villosissima, stylis
 liberis apice tantum glabris. *Fructus* globosus, 3-4 lineas diametro,
 glaber, nitidus, laciniis calycinis reflexis coronatus, graciliter pedun-
 culatus.

A very distinct species, remarkable for the small size of its yellow
 flowers and for the very broad bases of its homomorphous prickles,
 resembling closely in this respect the Central-Asian *R. platyca-
 antha*, Schrenck. It differs from the section *Eglanteriæ*, as de-
 fined by Boissier, 'Flora Orientalis,' ii. p. 669, in not having
 dimorphic spines, and appears to be intermediate between the
Eglanteriæ and Boissier's section *Elymaiticæ*.

A small erect stiff shrub; stems covered with extremely nume-
 rous straight prickles varying in size; leaflets 5 to 9, very small;
 flowers yellow, scarcely 1 inch in diameter; fruit small, globose,
 reddish, erect. A very common and characteristic shrub from
 Habîbkalla to Alikhél, forming, with *Amygdalus eburnea*, the
 greater part of the scrub on the stony ridges of the Hariáb district.
 Named after Mrs. Aitchison.

Pyrus Malus, L.

Several varieties of apples are cultivated in the orchards; none,
 however, very good.

P. communis, L.

I have never seen any fruit, and very occasionally a pear-tree
 in the gardens.

P. sp.

A middle-sized tree near Badishkhél; only one tree, not culti-
 vated.

742. P. lanata, Don.

A small tree in the forests at 8000 to 10,000 feet, up the
 Shéndtoi and Gandháo ravines. The fruit is eagerly sought by
 the shepherds, and called by them "Amlök," the same name as
 that applied to the fruit of *Diospyros*.

792. *Pyrus Aucuparia*, Gært.

Amongst the shrubs at the limit of forest, or nearly so, in the Shéndtoi gorge, at from 10,000 to 11,000 feet, not common; July.

0. *Cratægus Oxyacantha*, L.

With very large fruit; may be a variety. A common shrub at 8000 feet round Shálizán; usually forms a good tree in the Hariáb district.

325. *Cotoneaster bacillaris*, Wall.

A large shrub, the wood of which is in much request for the handles of farm instruments, staves, and bows. Forms a great part of the scrub within the hills from 7000 to 8500 feet. Scarcely occurs in the Hariáb district.

204. *C. nummularia*, Fisch.

Occurs from the vicinity of Thal, along the whole road as far as Alikhél, making up largely with *Sophora* and *Daphne* the scrub vegetation of the stony arid spots. These three plants seem to withstand a great amount of variation of temperature.

363. *C. nummularia*, Fisch., var. *tomentosa*.

This, I have no doubt, is a distinct species. The upper surface of the leaves is extremely glabrous, whilst their under surface is excessively tomentose. The habit of the plant is very different from the type. It occurs only at about 8000 feet, and does not ascend to the Hariáb district.

182. *C. vulgaris*, L., var. ? Fere omnino glabra, ramis gracillimis, floribus parvis.

A very graceful tall shrub with lax corymbose pink inflorescence. Only collected in July, at 10,000 feet, in the high forest up the Shéndtoi gorge.

0. *C. sp.* Probably the as same 782.

Collected at Kaiwás; July.

26. SAXIFRAGACEÆ.

163. *Saxifraga ligulata*, Wall.

On damp rocks at from 8000 to 10,000 feet; profuse. In spring the flowers are greatly worn behind the ear by young men and women of the villages.

383. *S.* (§ *Kabschia*, Engler) *afghanica*, Aitchison et Hemsley, n. sp.

Cæspitosa, pygmæa, foliis oblongis dense imbricatis, caulibus floriferis vix pollicaribus glandulosis sæpissime trifloris, floribus majusculis pallide purpureis, petalis obovatis quam stamina longioribus, seminibus oblongis pilis brevibus debilibus sparsim instructis.

Herba perennis, cæspitosa, caulibus densissime foliosis interdum usque tripollicaribus sed sæpissime vix pollicaribus. *Folia* dense imbricata, carnosa, oblonga, 3-4 lineas longa, obtusa, supra parce foveolata, margine anguste cartilaginea, infra medium ciliata, caulina spathulata vel lineari-oblonga, glandulosa; caules floriferi glandulosi, vix pollicares, sæpissime triflori. *Flores* pallide purpurei, circiter 6 lineas diametro; calycis glandulosi segmenta oblonga, obtusa; petala obovata, 5-nervia, staminibus longiora; styli elongati, demum divergentes. *Capsula* globosa; semina minuta, oblonga, pilis brevibus debilibus sparsim conspersa.

Near *S. Kotschyi*, Boiss., but differing in the colour and size of the flowers, in the relative length of the petals and stamens, and in the seeds, as well as in the cymes being almost constantly three-flowered. A very characteristic rock-plant, covering stones like rich moss; would prove very effective in a rockery. The flower is a grey-purple, and extremely large for the short mossy stem; it is borne on a peduncle of an inch in length. Chiefly met with in the Shéndtoi gorge at from 7500 to 11,000 feet. Flowers from May to July.

943. *Parnassia ovata*, Ledeb.

In grassy spots at the exits of springs, altitude 9000 to 11,000 feet; common in the vicinity of Sîkarám; August.

413. *Ribes Grossularia*, L.

Very profuse at the base of Sîkarám and westward to Serátigah, in certain localities, amongst thin forests, altitude 9000 to 10,000 feet. In one or two villages of the Hariáb district it is employed as a hedge-plant. The fruit is much superior to that produced in Ladák.

128. *R. orientale*, Poir.

A very common shrub in rocky dry situations throughout the Hariáb district up to an altitude of 11,000 feet. The berries, called "*Aksîswérai*," are considered an excellent purgative taken one or two at a time.

0. *R. rubrum*, L. var.

A handsome leafy bush at 9000 to 11,000 feet, under trees in the forest, Shéndtoi gorge; August, in fruit.

27. CRASSULACEÆ.

456. *Crassula* sp.

On rocks in the Shéndtoi gorge, common; June.

538. *Cotyledon* (§ *Umbilicus*) *tenuicaulis*, Aitchison et Hemsley, n.sp.

Perennis, minima, foliis radicalibus rosulatis oblongo-spathulatis vix

semipollicaribus, caulibus floriferis extrarosularibus gracillimis glanduloso-puberulis, floribus roseis vel purpureis parvis dichotomo-cymosis, corollæ lobis longe acuminatis apiculatis erectis tubo paullo longioribus.

Herba perennis, gracillima caulibus floriferis glanduloso-puberulis 2-4-pollicaribus. *Folia* radicalia et caulina inferiora rosulata, carnosa, obovato-spathulata, 2-4 lineas longa, primum albo-furfuracea, caulina superiora minima, linearia, appressa. *Flores* pallide rosei, 2-2½ lineas longi, dichotomo-cymosi; calycis glanduloso-puberuli lobi ovati, obtusiusculi, semilineam longi; corollæ obsolete puberulæ lobi longe acuminati, apiculati, carinati, tubo longiores; stamina inclusa; filamenta filiformia. *Carpella* glabra.

This differs from all other species of the section *Rosularia* in its small size, slender habit, and small flowers.

Alikhél; June.

243. *Cotyledon (Umbilicus) papillosa*, Aitchison et Hemsley, n. sp.

Humilis, ramosa, foliis confertis carnosis obovato-spathulatis glabris, ramulis floriferis floribusque dense glanduloso-papillosis, floribus numerosis parvis albo-roseis, corollæ lobis erectis carinatis apice apiculatis breviter recurvatis dorso papillosis tubo paullo longioribus.

Herba perennis, 3-4-pollicaris, basi ramosa, ramulis floriferis graciliusculis floribusque dense glanduloso-papillosis. *Folia* carnosa, in ramis sterilibus conferta, sed vix rosulata, in ramis floriferis sparsa et sursum gradatim minora, inferiora glabra vel cito glabrescentia, obovato-spathulata, usque ad 8 lineas longa, superiora lineari-oblonga, papillosa. *Flores* albo-rosei, numerosi, ad 2½ lineas longi, cymosi, breviter pedicellati; calycis glanduloso-papilloso lobi lanceolato-oblongi, obtusiusculi; corolla calyce fere duplo longior, extus glanduloso-papillosa; lobi erecti, carinati, paice breviter recurvato-apiculati; stamina 10, inclusa; filamenta filiformia; squamæ parvæ, subquadrato-oblongæ. *Carpella* glabra.

In habit this resembles the Sikkim *C. obovata*, which has larger, yellow, less numerous flowers. Kuram; April.

851. *Sedum asiaticum*, DC.

Serátigah, altitude 13,000 feet; July.

0. *S. rosulatum*, Edgew.

936, 1000. *S. Ewersii*, Ledeb.

Profuse in rocks from 9000 to 12,000 feet.

469. *S. pachyclados*, Aitchison et Hemsley, n. sp. Perenne, nanum, glaberrimum, rhizomate crasso sæpissime ramoso, ramis (caudiculis auct.) apice tantum foliosis, ramulis floriferis axillaribus brevissimis paucifloris, foliis rosulatis parvis carnosis apice sæpe 3-5-dentatis, floribus stramineis mediocribus.

Herba perennis, nana, omnino glaberrima, rhizomate crasso usque ad 5-pollicari sæpissime ramoso; rami ad 3 lineas diametro, apice tantum

foliosi; ramuli floriferi axillares, 6-12 lineas longi, 2-10-flori. *Folia* carnosae, rosulatae, obovato-spathulatae vel suborbicularia, 3-5 lineas longa, apice saepe 3-5-dentata, caulina obovata basi soluta. *Flores* stramineae, 4-5 lineas diametro, brevissime pedicellatae; sepalae subcarnosae, oblongae, obtusae, petalis $\frac{1}{3}$ - $\frac{1}{2}$ breviora, basi haud producta; petala tenuia, oblongo-spathulata, obtusa, subtrinervia; stamina 10, alterna petalis adnata, filamentis filiformibus petalis paulo brevioribus. *Carpella* subinflata, longe rostrata, oligosperma; semina matura non visa.

This species is very distinct from all others that we have seen. Profuse in rocks between Shálizán and Shéndtoi; June and July.

937. *Sedum adenotrichum*, Wall.

At 11,000 feet, Sikarám; August.

935. *Sempervivum acuminatum*, Dcne.

Very profuse on the ascent to Sikarám and to Serátígah, on stony débris at 10,000 to 12,000 feet; August.

28. HAMAMELIDÆ.

291. *Parrottia Jacquemontiana*, Dcne.

A very abundant shrub, occurring in the interior of the hills and forming much of the low dense shrub-jungle which grows in the damper localities and northern exposure of these hills from 7500 to 9000 feet (if so much). The long slender stems and pliant branches are much employed in making the wicker-work of which most of the houses in the villages consist, and which are plastered over with clay, also as handles for ordinary farm implements axes, &c.

29. MYRTACEÆ.

47. *Myrtus communis*, L.

Occasionally met with in local dense clumps on cultivated land. In all cases the bushes seem very old, and most probably had been planted beside graves. Very common in this form near Ibrahimzai, Alizai, and Badishkhél, villages on the Kuram river, from 3500 to 4000 feet in altitude. Not seen near Kuram. I never met with solitary bushes.

30. LYTHRACEÆ.

0. *Ammannia senegalensis*, Lamk.

In rice-fields at Shálizán, August; very common.

0. *Punica granatum*, L.

A common wild shrub, forming part of the scrub of the outer hills at from 6500 to 7000 feet; not in the Hariáb district.

31. ONAGRACEÆ.

1008. *Epilobium angustifolium*, L.

A very handsome and characteristic plant at 10,000 to 11,000 feet, near moisture.

781. *E. angustifolium*, L., var. *brachycarpum*.

In similar localities to the above ; August.

875. *E. hirsutum*, L., var. *sericeum*.

Very common from Kuram to Habíbka, up to 7000 feet, in wet localities.

939. *E. roseum*, Sch.?

Síkarám, in stony beds of streams at 11,000 feet.

651. *E. tetragonum*, L.

Very common around Shálizán ; July and August.

0. *E. sp.*

Shálizán ; June.

32. CUCURBITACEÆ.

3. *Cucumis Melo*, L., var.

The specimens collected were of the form usually occurring as a weed all over the dry hot fan country, sides of fields, &c. Melons, water-melons, cucumbers, and gourds are very largely cultivated from Thal to the foot of the Péwáarkotal ; scarcely any of these, except a cucumber, in the Hariáb district.

533. *Bryonia dioica*, Jacq.

A most extensive weed, covering the hedgerows in the Hariáb district. Specimens of this plant were collected by the Rev. Mr. Jaeschke in Lahul, and are in the Kew Herb., but were overlooked by Mr. C. B. Clarke in his monograph of the order in the 'Flora of British India.'

33. UMBELLIFERÆ.

472 a. *Eryngium cœruleum*, Bieb.?

At Shálizán ; May.

427. *E. Billardieri*, Delar.

Shálizán, very common ; June.

0. *Bupleurum falcatum*, L., var. *linearifolium*.

Kaiwás, very common and generally all over the district above 4000 feet alt. ; June.

0. *B. falcatum*, L.?

Alikhél ; July.

929. *Bupleurum* sp.

A very abundant, creeping, close-growing plant amongst stones at 12,000 to 14,000 feet, Sīkarám; August.

663. *Apium graveolens*, L.

Very common at about 7000 feet, along banks of watercourses and at spring-heads on rocks, Shálizán; June.

417. *Conopodium* sp.

Shálizán; June.

513. *Carum Bulbocastanum*, Koch (= *Stocks*, 1056).

Profuse, Bíánkhél, under bushes at from 2000 to 3000 feet; June. This plant also occurs in large quantity in the Rawul Pindee district of the Punjab.

478. *C. Bulbocastanum*, Koch, var.

Zabardastkalla, in fields, profuse; June. Wild pigs cause great injury in fields where this and the last species are prevalent as weeds by uprooting the tubers.

296, 248. *C. copticum*, Benth.

Cultivated more or less in small patches of garden ground, mixed up with several other vegetables. Very common, either as an escape or spontaneously, from Thal to Alikhél; May and June.

895, 991. *Pimpinella diversifolia*, DC.

Péwárkotal and Shéndtoi at an altitude of 8500 feet, profuse under trees; July and August.

752. *P.* sp.?

Shéndtoi, in dry stony spots; July.

846. *P.* sp.

Drékalla, very rare in certain localities amongst the broken débris of stones; July.

772. *Chærophyllum reflexum*, Lindl.

Shéndtoi, profuse in grassy wet ground associated with *Pedicularis*, *Primula*, *Caltha*, &c., at 9000 feet; July.

592. *Scandix Pecten-Veneris*, L.

Fields, not common, Karchátál; June.

873. *Seseli sibiricum*, Benth.

Very common and prominent on large rocks, Alikhél and Sergal; August.

514. *Conium maculatum*, L.

Bíánkhél only, round the village; June. This plant had not previously been collected so far east.

311. *Foeniculum vulgare*, Gaertn.

Cultivated as *Carum copticum* is, and, like it, often an escape, or probably indigenous.

854. *Frangos pabularia*, Lindl.

Serátígah, at 9000 feet, very common; also Drékalla. July was far too late to collect this plant, as I could scarcely get even a few leaves. I found no fruit.

821. *Ligusticum* ?

Not uncommon from 11,000 to 15,300 feet, Serátígah, Sikarám, &c., in clefts of rocks. Very late in flowering, not in good flower, and no sign of fruit August 4th. The Goorkhas would eat it, and said they knew what it was quite well; they upset all my arguments on the subject by telling me they had on their hills every plant we saw, besides thousands of others.

992. *Selinum papyraceum*, C. B. Clarke.

Shéndtoi, in moist ground, 9000 feet; August.

953. *Pleurospermum* (*Hymenolæna*) *corydalifolium*, Aitchison et Hemsley, n. sp. Glaberrimum, caule cavo subsimplici, foliis radicalibus amplis longe petiolatis bipinnatisectis, segmentis secundi ordinis profunde palmatisectis, segmentis ultimis angustis acutis vel obtusiusculis, involucre sæpissime bibracteolato, umbella composita 3-7-radiata, bracteolis plurimis amplis integris quam pedicelli longioribus bracteisque albis, fructus immaturi jugis primariis alatis.

Herba erecta, 9 poll. usque ad bipedalis, omnino glaberrima, caule erecto cavo subsimplici tenuiter striato. *Folia* oblonga vel rhomboidea, bipinnatisecta, lamina usque ad 6-pollicari; segmenta secundi ordinis subrhomboidea, profunde palmatisecta; segmenta ultima angusta, acuta vel obtusiuscula; petiolus teres, basi tantum dilatatus, foliorum radicalium usque ad 8-pollicaris; vaginæ foliorum supremorum bracteæ et bracteolæ albæ. *Umbellæ* compositæ, 3-7-radiatæ, maximæ 2½ poll. diametro; radii usque ad sesquipollicares, striati; involucri bracteæ sæpissime 2, interdum 3, inæquales, oblongæ, integræ, 3-9 lineas longæ et usque 3 lineas latæ, ascendentes; umbellulæ multifloræ; pedicelli graciles, breves; bracteolæ pulchræ, præter costam viridam albæ et interdum roseo tinctæ (more *Astrantiæ*) ovato-ellipticæ, integræ, pedicellis longiores. *Flores* albi, majusculi; calycis dentes majusculi, acuti; petala æqualia, orbicularia, apice inflexa; discus maximus, carnosus, margine undulatus; styli longiusculi, demum reflexi. *Fructus* immaturus ovato-oblongus, subteres, jugis primariis distincte alatis; valliculæ univittatæ?

This species is nearest to *Hymenolæna Lindleyana*, Klotzsch in Reise Pr. Waldem., Bot. p. 150, t. 49; *Pleurospermum stellatum*, Benth., var. *Lindleyana*, C. B. Clarke in Fl. Brit. Ind. ii.

p. 705, but it is very different from it in foliage and the bracts of the involucre. The large white involucre makes this a most attractive plant. It is common from 9000 to 14,000 feet on shelving rocks and in dampish localities, Sikarám, Shéndtoi; August.

743, 744. *Pleurospermum (Hymenolæna) pulchrum*, *Aitchison et Hemsley*, n. sp. Elatum, glaberrimum, caule solido sæpe ramoso, foliis mediocribus bipinnatisectis, segmentis ultimis pinnatifidis acutis, caulino-
rum vaginis bracteis numerosis bracteolisque albo vel roseo marginatis, umbellis umbellulisque multiradiatis, bracteis reflexis sæpissime trifidis, fructu ovato-oblongo a latere leviter compresso, jugis primariis alatis, valleculis univittatis, seminibus liberis sulcatis.

Herba erecta, 2-3-pedalis, omnino glaberrima, caule erecto sæpe ramoso solido pro genere gracili tenuiter albo vel purpureo-striato folioso. *Folia* fere æqualiter triangularia vel rhomboidea, subternatim bipinnatisecta, lamina 2-3 poll. longa et lata; segmenta secundaria rhomboidea, pinnatifida; segmenta ultima acuta; petiolus gracilis, basi tantum dilatatus, usque 4-pollicaris, sursum gradatim angustior; foliorum caulino-
rum vaginæ bracteæ et bracteolæ albo vel roseo marginatæ. *Umbellæ* compositæ, multiradiatæ, maximæ 4 poll. diametro; radii usque ad 2½ poll. longi, tenuiter sulcati et furfuracei; bracteæ numerosæ, amplæ, 6-12 lineas longæ, reflexæ, sæpissime trifidæ; umbellulæ multifloræ; pedicelli graciles, breves; bracteolæ reflexæ, lanceolatæ, acutæ, interdum trifidæ, pedicellis paulo longiores. *Flores* albi vel roseo tincti, majusculi; calycis dentes minuti, acuti; petala æqualia, suborbicularia, apice inflexa; discus maximus, carnosus, margine undulatus; styli longiusculi, demum reflexi. *Fructus* ovato-oblongus, ad 3 lineas longus, a latere leviter compressus, rugosus, jugis primariis distincte alatis; valleculæ univittatæ, vittis tenuissimis; semina undique libera, facie interiore sulcata.

A very distinct species, especially in its tall stature and slender habit. Not common under rocks at from 8000 to 12,000 feet; July and August.

834. *Ferula Jaeschkeana*, *Vatke*.

This plant may be said to cover the ground in the thin forests on the road between Drékalla and Káratigah, yet with rare exception did I find it in fruit, owing to my being too late in the season. These forests should be visited in June. It is common enough on all the hills to the north of the Hariáb district, at 10,000 to 11,000 feet.

848, 930, 738, 948. *Peucedanum* sp., = *Griffith*, 1108.

Common on stony ground at from 9000 to 12,000 feet, Kaiwás, Drékalla, and Sikarám; August.

760. *Heracleum* sp. near *H. candicans*, *Wall*.

Near water, sides of fields, common at 7000 feet; July.

880, 906. *Daucus Carota*, L.

Specimens from cultivation. Cultivated as a field crop in the Hariáb district up to 9000 feet; the produce, however, is poor. No 906 is undoubtedly the wild state, as this plant was collected by me occasionally throughout the hills and fields from 7000 to 9000 feet. July and August.

679, 907. *Caucalis Anthriscus*, Scop.

Fields, very common, Shálizán; June to August.

226, 505. *C. latifolia*, L.

Very common in the Hariáb district, June to August; Kuram, April.

34. ARALIACEÆ.

164. *Hedera Helix*, L.

Very common in the moist woods, but chiefly trailing on the ground, scarcely ever climbing trees; not noticed in the Hariáb district. Fruit yellow or reddish.

GAMOPETALÆ.

35. CAPRIFOLIACEÆ.

230, 290. *Viburnum cotinifolium*, Don.

A very common shrub from 7000 to 9000 feet in the Kuram district; not uncommon on the outer edge of forests in the Hariáb district; May and June.

341. *Abelia triflora*, R. Br., var. *parvifolia*.

A very common dense shrub from 7000 to 10,000 feet, Kuram district; June to July. Not in Hariáb.

731, 466. *Lonicera alpigena*, L.

A large shrub from 10,000 to 11,000 feet alt.; not uncommon in Kaiwás and Shéndtoi; July.

830. *L. glauca*, Hook. f. & Thoms.

At Serátigah, 13,000 feet, where it grows in fissures of rocks, which renders it very difficult to get good specimens. Flowers lemon-yellow.

535. *L. Griffithii*, Hook. f. & Thoms.

A magnificent climber, with very handsome rose-coloured flowers; common from the base of Péwáarkotal, alt. 7000 feet, to Alikhél and Káratigah; July and August.

494. *Lonicera microphylla*, Willd.

West base of Sîkarâm, from 10,000 to 12,000 feet. Flowers whitish yellow, fruit bright red; June to August.

393. *L. Myrtilus*, Hook. f. & Thoms.

From 9000 to 14,000 feet, in Shéndtoi and Sîkarâm. Flowers waxy white, fruit orange-red.

1221. *L. obovata*, Royle.

A woody close-growing shrub, Sîkarâm, at 10,000 to 12,000 feet. Fruit deep purple.

739. *L. orientalis*, Lamk.

At 12,000 feet on hills north of Kaiwás; July.

509, 162, 550. *L. quinquelocularis*, Hardw.

A large shrub, almost a tree in some places. Very common from 7000 to 9000 feet, forming much of the low scrub on northern exposures and in shaded localities. It sheds the external layers of its bark in long fibrous strips resembling coarse hemp-fibre; this is collected and employed as rope, but has little or no strength. Only suitable for stuffing mattresses and such purposes. Flowers largish, yellow; April to June. Kuram and occasional in the Hariáb district.

1222. *L. sericea*, Royle. (*L. purpurascens*, Jacq.)

Shéndtoi, at 10,000 feet; August.

36. RUBIACEÆ.

552. *Callipeltis Cucullaria*, Stev.

Alikhél, profuse under shrubs and stony ground; June.

628, 256. *Rubia cordifolia*, L.

A very common weed in hedges all over the country, always in damp localities, from Kuram to Alikhél; May and June.

629, 351, 563. *R. Kotschyi*, Boiss.

In similar localities to the former and as common. The roots are employed in colouring hard boiled eggs for religious feasts.

156, 37. *Galium Aparine*, L.

Habíbkalla; April.

0. *G. tricornis*, L.

Shálizán; June.

797. *G. asperifolium*, Wall.

Shéndtoi, at 10,000 feet; July and August.

401. *Asperula odorata*, L.

Very common at 9000 feet from Shéndtoi and Kaiwás; May and July.

467, 366. *A. Cynanchica*, L.

Hanging in great bunches from the damp rocks in Shéndtoi gorge; also common near Kaiwás, 7000 to nearly 9000 feet.

618. *A. pycnantha*, Boiss.

A large climber, Shéndtoi; June.

631. *A.* sp.

Shálizán, in woods; June.

517. *Crucianella glomerata*, Bieb.

Profusely covers the dry stony soil on exposed ridges, Bíánkhél.

37. VALERIANEÆ.

829. *Valeriana dioica*, L.

Serátigah, at 13,000 feet, not common; July.

380. *V. Wallichiana*, DC.

Profuse, Shéndtoi, at 9,000 feet. Its large rootstocks are collected for their scent and exported. Also Kaiwás; July.

192. *V.* sp., = *Griffith*, no. 759.

Common under bushes at Alikhél in April.

956. *V. petrophila*, Bunge.

Síkarám, at 14,000, on shady rocks; August.

98. *V.* sp.

Alikhél, amongst shrubs; April.

219, 59. *Valerianella*, sp., = *Stocks*, 891.

Very common on dry stony soil, Kuram district, to 6000 feet.

38. DIPSACACEÆ.

420. *Morina persica*, L.

Very common up to 9000 feet, on exposed bare pieces of hill-side. Flowers rose-pink. My specimens unite *M. Wallichiana*, Royle, with *M. Persica*, L.

746. *M. Coulteriana*, Royle.

At and above 11,000 to 13,000 feet this yellow-flowered species quite replaces *M. Persica*, which grows at a lower altitude, and never ascends fairly up to the region of this plant.

658. *Cephalaria syriaca*, Schrad.

Shálizán; June.

642, 641. *Cephalaria* sp.

Shálizán; June.

551. *Scabiosa Olivierii*, *Coult.*

Common in dry stony localities from Kuram to Alikhél; May and June.

707. *S.* sp.

Kaiwás; July.

82. *S.* sp.

Extremely profuse everywhere, from Kuram all over the dry country to Alikhél and Káratígah; May and June.

883. *S. (Pterocephalus) afghanica*, *Aitchison et Hemsley*, n. sp., = 761 and 856, *Griffith*. Suffruticosa, cæspitosa, nana, ramis brevissimis, foliis viride puberulis spathulatis et integerrimis vel lyrato-pinnatifidis, capitulis breviter pedunculatis vel subsessilibus sæpe 18-25-floris, involucello truncato, calycis aristis 17-18.

Suffrutex densissime cæspitosus, 1-3 poll. altus, ramis procumbentibus crassis. *Folia* conferta, sessilia, spathulata, integerrima vel anguste lyrato-pinnatifida, 6-15 lineas longa, minute puberula, viridia. Capitula solitaria, terminalia vel pseudo-terminalia, sæpe 18-12-flora, subsessilia, vel pedunculo usque ad pollicari; involucri bractæ 9-11, pubescentes, lanceolatae, biseriatae, floribus breviores. *Flores* lilacini, exteriores bilabiati, interiores tubulosi, 5-dentati; receptaculum pilosum; involucellum sericeo-hirsutum, truncatum; calycis aristæ 17-18, plumosæ, corollæ fere æquilongæ; corolla extus hirsuta.

Allied to *Pterocephalus Parnassi*, Spreng., and *P. Pinardi*, Boiss., from both of which it is readily distinguished by its almost glabrous foliage and other characters. Very local, but gregarious in great patches. Bíánkhél, Sergal, west base of Síkarám, alt. 9000 feet. Has a very large purple handsome inflorescence for a small stunted woody-rooted plant.

39. COMPOSITÆ.

1237. *Solidago Virga-aurea*, *L.*

Shéndtoi, 8000 to 9000 feet, common; July.

994. *Myriactis Wallichii*, *Less.*

Profuse at 8000 to 10,000 feet; Shéndtoi; August.

244. *Aster altaicus*, *Willd.*

One of the most common plants in the dry country from Thal to Alikhél, all through the summer and late into winter; November 1878. The flowers vary greatly in size.

812. *Aster Amellus*, L.

A very handsome plant, hanging from clefts of rocks, from 7000 to 8000 feet.

951. *A. Heterochæta*, Benth.

Common on rock débris from 13,000 to 14,000 feet, on ridges of Sîkarâm. Flowers a fine purple, large; August.

901. *A. roseus*, Stev.?

Shâlizân, near water; July.

963. *Erigeron acris*, L., var. *alpina*, Lamk.

Profuse on rocks at 10,000 feet (above 67th Regiment encampments) at the foot of Sîkarâm.

496. *E. andryalcoides*, C. B. Clarke.

Base of Sîkarâm, common in pine-forests at 10,000 to 11,000 feet; June.

292. *E. monticola*, Wall.

Shâlizân, in fields; May.

784. *E. multiradiatus*, Benth.

In dry beds of streams, amongst stones, at 9000 to 10,000 feet; August.

1236. *Brachyactis robusta*, Benth.

Common in moist places at 8000 to 9000 feet, Shéndtoi; August.

920. *B. pubescens*, Aitch. & Clarke (*Conyza pubescens*, DC.).

On stony ground, Péwârkotal, and ascending Sîkarâm; August.

4. *Blumea Wightiana*, DC.

A common herb near water, on moist clay-banks; odour menthoid.

1224. *Filago arvensis*, L.

Bíánkhél; August.

778. *Leontopodium alpinum*, Cass.

Common on exposed hill-sides, from 10,000 to 14,000 feet.

914. *Anaphalis tenella*, DC.

Sîkarâm, at and above 11,000 feet.

1225. *A. virgata*, Thoms.

Common from 9000 to 13,000 feet, Shéndtoi, Kaiwâs, and Sîkarâm; August.

1223. *A. sp.* near *A. Falconeri*, C. B. Clarke.

Large pink-flowered species, common with the last.

801. *A. sp.*

Shéndtoi; July.

564. *Phagnalon acuminatum*, Boiss.
At Alikhél; June.
- 229, 298. *P. denticulatum*, Dcne.
At Shálizán, amongst stones; April and May.
266. *Gnaphalium crispatum*, Delile.
Kuram; April.
- 200, 253, 283, 567. *G. luteo-album*, L., var. (*G. confusum*, DC.)
Common from Kuram to Alikhél, usually on wet rocks; May and June.
976. *Inula Caspia*, Blume.
Alikhél, profuse; August.
942. *I. rhizocephaloides*, C. B. Clarke.
At spring-heads, appearing amongst grass; common from 8500 to 11,000 feet; August.
987. *Carpesium cernuum*, L., var. *pubescens* (sp., Wall.).
In orchards, Shálizán; August.
268. *Xanthium Strumarium*, L.
Profuse in fields in the Hariáb district; August.
1228. *Siegesbeckia orientalis*, L.
A common field-weed at Shálizán; August.
7. *Eclipta alba*, Hassk.
Near water, Mandúrí; April.
- 660, 982. *Bidens pilosa*, L.
Shálizán, on open stony ground; June.
972. *B. tripartita*, L.
In fields between Alikhél and Drékalla.
- 60, 245. *Achillea leptophylla*, Bieb.
Profuse on occasionally inundated clay soils, Sadatkalla and Kuram; April.
675. *Chrysanthemum Parthenium*, Benth.
Near Shálizán; June and July.
479. *Matricaria disciformis*, DC.
A profuse weed in fields all over the Hariáb district; June.
593. *M. suaveolens*, L.
In fields at Karchátal; June.
572. *Tanacetum millefoliatum*, Fisch. & Mey.
Very local in the Hariáb district; June and July.
820. *T.* sp. = *Griffith*, no. 941.
A very woody shrub from 10,000 to nearly 13,000 feet, Serátigah, Sergal, and Síkarám.

865. *Artemisia Absinthium*, L.

Extremely common from Kuram and Shálizán to Alikhél ; July.

1231. *A. parviflora*, Roxb.

Common in the plain country from Kuram to Habíbkalla ; July.

1232. *A. persica*, Boiss.

Sergal, from 10,000 to 11,000 feet ; August.

872. *A. scoparia*, Wald. & Kit.

Profuse shrub, 8000 to 9000 feet, Hariáb district.

984. *A. Tournefortiana*, Reich.

Grows to the height of nearly 7 feet. Common in the fields of the Hariáb district and occasional about Shálizán ; does not flower until September.

173. *Tussilago Farfara*, L.

Common in the Hariáb district ; April to July.

996, 773. *Senecio chrysanthemoides*, DC.

Shéndtoi, from 8000 to 10,000 feet, amongst grass in open spots. Very local, and giving distinct coloured patches to the hill-sides ; July and August.

546. *S. coronopifolius*, Desf.

Alikhél ; June.

1230. *S. pallens*, Wall., var. *violacea*.

Not uncommon at 8000 to 9000 feet, from Kaiwás to Shálizán.

1229. *S. sisymbriiformis*, DC.

Amongst stones in water near Sergal, not common ; August.

833. *Ligularia persica*, Boiss.

Káratígah at 9000 feet. Spike of inflorescence very handsome.

77. *Othonnopsis intermedia*, Boiss.

The characteristic shrub of the Kuram plains and dry water-courses. It has vertical leaves, and the flowers are produced all the summer.

522. *Atractylis cuneata*, Boiss.

Profuse, in the Hariáb district only, at 7000 to 9000 feet ; flowers in August.

683. *Arctium Lappa*, Willd.

A weed in orchards at Shálizán ; June.

1233. *Cousinia microcarpa*, Boiss. ? = *Griffith*, no. 3269.

At Drékalla ; August.

837. *Cousinia minuta*, Boiss.

Drékalla; July.

1226. *C. multiloba*, DC. = Griffith, nos. 3327 & 3326.

At Bíánkhél, common to 9000 feet.

1234. *C. sp.* (probably the same as 1226).850. *C. racemosa*, Boiss.

The most common *Cousinia* at 8000 to 11,000 feet, from Kuram along the dry country and on the Mergs at the Kotal.

923. *C. sp.*

Common from 9000 to 11,000 feet, Síkarám. A species between *C. multiloba*, DC., and my 921.

921. *C. sp.*

This is an extremely woolly form. Síkarám, from 10,000 to 14,000 feet, on stony ground.

922. *C. sp.*

Síkarám, 11,000 to 13,000 feet. The leaves on drying become quite yellow, as if a dye had become matured in the process of drying.

971. *C. sp.*, near *C. heterolepidis*, C. Koch.

On fields near Alikhél; August.

362. *C. sp.* near *C. microcarpa*, Boiss. = Griffith, 3271.

A dry hot-country form from Kuram to Shálizán and Habíbkalla, amongst stones.

221, 301, 706. *Carduus acanthoides*, L.

Common everywhere in fields from 5000 to 9000 feet.

751, 877. *Cnicus argyranthus*, DC.

Kaiwás and Shálizán to Shéndtoi. It is a moist-country plant, also met with in great luxuriance in the Murree Himalaya.

698. *C. arvensis*, Hoffm.

A common field-weed in the Hariáb district, and occasional round Shálizán; June.

970. *C. horridus*, Bieb.

Amongst débris at Drékalla, at 8500 feet, growing to 5 feet in height.

871. *Onopordon Acanthium*, L.

Hariáb district only. A large plant surrounding village filth-pits.

319, 888, 913. *Saussurea hypoleuca*, Spreng.

One of the few plants to be found growing freely under pine-

trees. Hariáb district and occasional near Shálizán; July and August.

29, 470. *Centaurea Calcitrapa*, L.

Common from Rohat to Shálizán, and I think in the Hariáb district; April to June.

160, 836. *C. depressa*, Bieb.

In corn-fields, from Kuram to Káratigah; April to July.

633. *C. Picris*, Pall.

In fields both at Sergal (8500 feet) and Shálizán, common; August.

1227. *C. virgata*, Lamk.

Between Zabardastkalla and Drékalla.

1235. *Carthamus oxyacantha*, Bieb.

Péwáarkotal; August.

399. *Ainsliæa aptera*, DC.

In damp forests from 8000 to 9000 feet; Shéndtoi.

721, 392. *Pertya Aitchisoni*, C. B. Clarke, n. sp. Foliis integris glabris, capitulis in ramis lateralibus abbreviatis sessilibus quasi racemum simplicem terminalem densiusculum efformantibus, phyllariis obtusis albide lanatis, achenio glabro glandulis stipitatis minutissime insperso, pappo albo.

Frutex. Folia alterna, sub capitulis aggregata. Pappus fructus tempore albus. Quoad cætera cum *P. scandente*, Schultze-Bip. in Bonplandia, 1862, t. 10, congruens.

Differunt:—

(a) *P. scandens*, Schultze-Bip. l. c., foliis lanceolatis denticulatis, capitulis in ramis brevibus divaricatis solitariis terminalibus 5-floris, phyllariis acutis fere glabris, achenio piloso, pappo proventu roseo-rufescente.

(b) *P. ovata*, Maxim. Mém. Biol. viii. 8, foliis ovatis denticulatis, capitulis in ramis elongatis solitariis terminalibus 15-floris, phyllariis acutis fere glabris, achenio sericeo, pappo proventu rufescente. Franch. et Savat. Enum. Pl. Jap. i. 265 errant; folia enim in his 3 speciebus alterna sunt.—
C. B. CLARKE.

A common shrub from 3 to 4 feet in height, with willow-like leaves and long slender branches. Common at 9000 to 11,000 feet, forming the undergrowth on the margins of forests. Also hanging from shady rocks, Kaiwás and Shéndtoi; July and August. This genus was previously only known from Japan.

324, 616. *Cichorium Intybus*, L.

Kuram and Shálizán, common, not Hariáb district; May and June.

518. *Koelipnia linearis*, *Pall.*

Profuse on hot exposed gravel soil near Bíánkhél.

805. *Picris hieracioides*, *L.*

A profuse field-weed at Katskallé, 7000 feet; July.

945. *Crepis Kotschyana*, *Boiss.*

On the Sergal stream at the base of Síkarám, alt. 8500 feet; August.

839, 859. *C.* sp. near *Youngia glauca* (Edgw.).

Very common from Alikhél to Drékalla; July.

312. *C.* sp.

Shálízan; June.

562. *C.* sp.

Alikhél; June.

79, 32. *Taraxacum Dens-leonis*, *Desf.*

Common from Badishkhél to Habíbkalla.

966. *T. montanum*, *C. A. Mey.*

At Sergal and between Rokian and Drékalla, very local. An extremely woolly plant; the leaves appear first, dying as the plant flowers and fruits; August.

450. *T. parvulum*, *Wall.?*

In all pine-forests in the Hariáb district, common at 8500 feet.

997. *Prenanthes* sp. near *P. lævigata*, *Wall.*

From 9000 to 11,500 feet, in damp woods at Shéndtoi. Flowers a lovely purple.

717. *Lactuca auriculata*, *DC.*

A profuse weed on the margins of fields at Shálízan &c.; flowers late in August.

997.
1. *L.* sp.1225. *L. orientalis*, *Boiss.*

Very common sticky plant on stony ground in Hariáb district.

999. *L. rapunculoides*, *C. B. Clarke.*

Common.

884. *L. viminea*, *Link.*

Very profuse in the Hariáb district along with *L. orientalis*; both are very characteristic plants; July.

329. *L.* sp. near *L. polycephala*, *C. B. Clarke.*

At Shálízan, on hot dry stony places, common; May.

35, 303. *Sonchus arvensis*, *L.*

Common up to 9000 feet, from Badishkhél.

306, 673, 704. *S. asper*, *L.*

Common in the vicinity of Shálizán and Kuram.

589. *Microhynchus asplenifolius*, *DC.*

Profuse on rocks, Karchátal; June.

672. *M. secundus*, *Royle.*

Not common, Shálizán; June.

83, 178. *Tragopogon junceum*, *Wall.*

Common under pine-trees, Habíbkalla, Serátigah, Síkarám up to nearly 14,000 feet, and Kuram; April to August.

84, 112, 123, 187. *Scorzonera mollis*, *Bieb.*

From Kuram up to 12,000 feet on Síkarám, also profuse on the Kuram plains, where it has a large tuberous root. April.

504. *Composita*, *sp.*

Radical leaves only. Síkarám; June.

40. CAMPANULACEÆ.

784. *Codonopsis ovata*, *Benth.*

Spring-heads in moist meadow-ground at the base of Síkarám and near Kaiwás, altitude 10,000 feet, common; July and August.

297, 669. *Campanula colorata*, *Wall.* = *Griffith*, no. 694.

Common near Shálizán and Habíbkalla on dry walls and stones; May and June.

530. *C. Griffithii*, *Hook. f. & Thoms.*

Common, Hariáb to Drékalla. A small stiff erect plant on open ground in stony soil; June and July.

0. *C. evolvulacea*, *Royle.*

Karchátal; June.

$\frac{941}{A}$. *C. sp.*

Síkarám, from 11,000 to 12,000 feet; August.

541. *C. sp.*

Alikhél, characteristic of clefts of rocks with *Dionysia* &c.; June.

941. *C. sp.*

Common from Shéndtoi to Sergal and Síkarám; July and August.

41. ERICACEÆ.

457. *Rhododendron afghanicum*, Aitchison et Hemsley, n. sp. Humilis, foliis mediocribus subtus lepidotis, pedunculis longiusculis 10-15 aggregatis, calyce inæqualiter 5-partito, segmentis brevibus rotundatis, corolla campanulata omnino glaberrima, lobis tubum æquantibus; staminibus 10 exsertis; ovario 5-loculare, stylo a basi abrupte curvo quam stamina paullo breviora.

Frutex venenatus, humilis, supra rupes repens et radicans, ramis junioribus minutissime lepidotis. *Folia* petiolata, coriacea, sempervirentia, lanceolato-oblonga, $1\frac{1}{2}$ - $2\frac{1}{2}$ -pollicaria, obtusa, supra glabra, subtus lepidota, lepidibus orbicularibus peltatis. *Flores* albo-virides, racemoso-corymbosi, longiuscule pedunculati, corymbis 10-15-floris ante anthesin bracteatis; bracteæ pluriseriatæ, rotundatæ, mucronatæ, ciliolatæ, exteriores haud minores; calyx 5-partitus, lepidotus, segmentis inæqualibus rotundatis; corolla campanulata, 5-6 lineas longa et lata, omnino glaberrima, lobis tubum æquantibus; stamina 10, exserta, filamentis filiformibus, infra medium longiuscule barbatis; ovarium 5-loculare, stylo a basi abrupte curvo, quam stamina paullo breviora. *Capsula* lepidota, ovato-oblonga, circiter 4 lineas longa.

In its principal features this is allied to *R. lepidotum*, from which it essentially differs in its inflorescence as well as in the details of less prominent characters. Abundant from 7000 to 9000 feet at Shéndtoi and Kaiwás; June and July. A poisonous shrub, with campanulate corolla and long bent style.

344. *R. Collettianum*, Aitchison et Hemsley, n. sp. Fruticosum, pluripedale, foliis mediocribus subtus furfuraceo-lepidotis, pedunculis brevibus sæpissime 8-12 aggregatis, calyce inæqualiter 5-partito, segmentis late oblongis ciliatis, corolla hypocraterimorpha, tubo recto intus omnino piloso; staminibus 10 inclusis; ovario 5-loculare, stylo brevissimo.

Frutex graveolens, innocuus, 4-7-pedalis, ramis junioribus fulvis furfuraceo-lepidotis. *Folia* petiolata, coriacea, sempervirentia, lanceolato-oblonga, sæpe 2-3-pollicaria (specimen Griffithianum paullo longiora), obtusiuscula, supra primum parce lepidota sed cito nuda et nitida, subtus fulva, furfuraceo-lepidota. *Flores* albi, roseo tincti, corymbosi, breviter pedunculati, corymbis sæpissime 8-12-floris ante anthesin bracteatis; bracteæ pauciseriatæ, lepidotæ, ciliatæ, rotundatæ, mucronatæ, exteriores minores; calyx 5-partitus, furfuraceo-lepidotus, segmentis inæqualibus oblongis longe ciliatis; corolla hypocraterimorpha, usque ad 10 lineas longa, extus glaberrima, lobis rotundatis, tubo recto quam lobi duplo longiore, intus omnino piloso; stamina 10, tubo inclusa, filamentis leviter barbatis deorsum incrassatis; ovarium 5-loculare, stylo brevissimo, stigmatate maximo capitato. *Capsula* furfuraceo-lepidota, oblonga, circiter 3 lineas longa, calyce persistenti vestita.

In most of its characters this species closely approaches *R. Anthopogon*, from which, however, it differs in its larger stature, larger straight flowers, ten stamens, and in the tube of the corolla being hairy all over the inside. From 10,000 to nearly 13,000 feet at Shéndtoi to ridges of Sikarám, commencing at near the limit of trees, and, mixed with masses of juniper, forming thicket. Has a long salver-shaped corolla and a short style.

42. MONOTROPEÆ.

912. *Hypopithys lanuginosa*, Nutt.

Growing under, and probably parasitical upon, the roots of *Abies Smithiana* at Péwárkotal, altitude 8500 feet; August.

43. PLUMBAGINEÆ.

813. *Acantholimon* (§ *Staticopsis*) *Munroanum*, *Aitchison et Hemsley*, n. sp. Foliis brevibus demum patentibus subulatis, scapis quam folia nunc brevioribus nunc paullo longioribus monostachyis, spicis densis, spiculis 2-7 unifloris tribracteatis, bracteis exterioribus ovato-orbicularibus semicupularis margine latiuscule scarioso-hyalinis, bracteis interioribus oblongo-ellipticis calyce triente brevioribus.

Suffrutex cæspitosus, usque ad pedalis, ramis elongatis. *Folia* rigida, demum patentia, subulato-acerosa, 6-9 lineas longa, margine minutissime scaberula. *Flores* congesti spicati; scapus nunc foliis brevior paullo longior; spicæ breves; spiculæ 2-7, unifloræ, tribracteatae; bracteæ exteriores, præter margo latiuscule scarioso-hyalina coriaceæ, ovato-orbiculares, semicupulares, mucronatæ; bracteæ interiores oblongo-ellipticæ, præter costam scarioso-hyalinæ, calyce tertio parte breviores; calyx infundibuliformis, tubo extus hirsuto sulcato, limbo albo atro-costato, costis haud excurrentibus; ovarium glabrum.

Allied to *A. libanoticum*, Boiss., *A. Echinus*, L., &c. Serátigah, forming immense consolidated hummocks; 10,000 to 13,000 feet, July.

0. *A.* (§ *Tragacanthina*, *Bunge*) *leptostachyum*, *Aitchison et Hemsley*, n. sp. Foliis æstivalibus longiusculis adscendentibus gracilibus semiteretibus acerosis. Scapus gracili pleiostachyus, spicis laxiusculis, spiculis 1-6 sæpissime 1-floris, bracteis similis glumaceis elongatis mucronatis præter costam crassam scarioso-hyalinis quam calyx paullo brevioribus.

Suffrutex usque ad 3-pedalis, dense ramosus, ramis graciliusculis rectis elongatis. *Folia* heteromorpha, vernalia carnosula, brevia, lata, recurva, persistentia, æstivalia gracilia, semiteretia, acerosa, 1-1½ poll. longa, adscendentia, obsolete puberula. *Flores* parvi, interrupte spicati; scapi 2-4 pollicares, graciles; spiculæ 1-6, sæpissime (an semper?) 1-floræ; bracteæ similes oblongo-ellipticæ, mucronatæ, præter costa crassa sca-

rioso-hyalinæ, calyce paullo breviores; calyx anguste infundibuliformis, glaber, limbus albus purpureo-costatus, costis haud excurrentibus; ovarium glabrum.

Drékalla; July.

Acantholimon (§ *Armeriopsis*, Boiss.) *calocephalum*, *Aitchison et Hemsley*, n. sp. Foliis brevibus patentibus crassis plano-triquetris acerosis, scapis quam folia brevioribus, spicis densissimis unilateraliter evolutis, spiculis usque 12 sæpissime trifloris, bracteis exterioribus maximis orbicularibus concavis margine tantum hyalinis, bracteis interioribus late obovato-ellipticis quam calyx paullo brevioribus.

Suffrutex cæspitosus, pedalis et ultra, ramis crassiusculis dense foliosis. *Folia* crassa, coriacea vel fere lignosa, linearia, acerosa, usque ad 9 lineas longa, plano-triquetra, minute albido punctata (puncta lacrymæ calcis?) margine minutissime scaberula, patentia, scapo longiora. *Flores* congesti, capitato-spicati; spicæ densissimæ, unilateraliter evolutæ, usque pollicares; spiculæ usque ad 12, distichæ, 2-5-floræ, sed sæpissime 3-floræ; bracteæ exteriores coriaceæ, amplæ, orbiculares, concavæ, mucronatæ, purpureo vel roseo zonatæ, margine anguste hyalino-membranaceæ; bracteæ interiores fere omnino hyalinæ, roseo vel purpureo tinctæ, obovato-ellipticæ, calyce paullo breviores; calyx infundibuliformis, omnino glaber, atro-purpureo costatus, costis haud excurrentibus; ovarium puberulum.

Near *A. bracteatum*, Boiss., but differing in its very shortly pedunculate spikes and quite coriaceous coloured outer bracts. Sîkarâm, forming immense hummocks, 11,000 to 13,000 feet.

44. PRIMULACEÆ.

130, 521. *Primula denticulata*, Sm.

Bíánkhél; April.

352. *P. denticulata*, Sm. var.

Shálizán; May.

462. *P. rosea*, Royle.

Shéndtoi ravine, at 9000 to 10,000 feet, very local.

960. *P. purpurea*, Royle = *Griffith*, no. 699.

Profuse from 11,000 to 15,000 feet on all the higher hills, Sîkarâm.

169. *Androsace incisa*, Wall.

At 7000 to 8000 feet from Shálizán to Habíbkalla, not uncommon.

925. *A.* sp.

At 13,000 feet on Sîkarâm; a very minute woolly plant.

323. *Androsace* sp.

Very common through the woods from Shálizán up to 9000 feet, and occasional in the Hariáb district.

131, 132, 874. *Dionysia tapetodes*, *Bunge*.

Profuse everywhere on shaded rocks from the Shéndtoi at 7000 feet to Káratígah. Very characteristic as a rock-plant. In flower April to June, according to elevation and exposure.

725. *Cortusa Matthioli*, *L.*

In shaded localities whether by trees or stones, the plant varying much in size. From 9000 feet in the Shéndtoi ravine, Kaiwás, and on Sikarám up to nearly 12,000 feet, common.

642. *Lysimachia dubia*, *Ait.*

An abundant weed around fields at Shálizán; June.

604. *Glaux maritima*, *L.*

Common in low grass, damp ground at Bíánkhél; June.

318. *Anagallis arvensis*, *L.*

The red-flowered form, Shálizán, not a common weed; June.

45. EBENACEÆ.

150. *Diospyros Lotus*, *L.*

A large tree, extensively cultivated in the Kuram district for its fruit; not met with in a wild state. It does not occur in the Hariáb district.

46. OLEACEÆ.

626. *Jasminum officinale*, *L.*

Shálizán, in the small jungle within the hills at about 8000 feet, common; June. Not found in Hariáb.

289. *J. revolutum*, *Sims.*

In similar localities to the above; also not occurring in the Hariáb.

722. *Syringa Emodi*, *Wall.*

A common shrub from nearly 8000 to 9000 feet; never occurs as low down as *S. persica* so as to mix with it. The flowers are always pure or greenish white, never purple.

188, 356. *S. persica*, *L.*

A very common shrub on the low and outer hills near Shálizán up to nearly 7500 feet; never quite reaches the altitude of *S. Emodi*. I have never seen these species growing together.

O. Fraxinus Moorcroftiana, Wall.

From a stout woody bush to a good-sized tree. On the ascent to Péwárkotal and occasionally all over the Hariáb district to Drékalla and Káratígah.

258. Olea cuspidata, Wall.

A cultivated tree in the Kuram district wherever I have seen it. It does not occur in the Hariáb district. Between Badishkhél and Thal not common, except in groves, where there can be no doubt it has been cultivated. From Ibrahimzai and across by the inland road to the Darwazaghai pass it is common as a wild tree, but on the pass itself is found in cultivated groves only. The Afghans have a superstitious veneration for this tree.

47. ASCLEPIADEÆ.

582. Vincetoxicum sp.=No. 7, T. Thomson's collection.

About 8000 feet, at Bíánkhél and Kaiwás, on open stony hot slopes; June, July.

44. Cynanchum humile, Falc.=No. 920, *Stocks*.

Shinnak, at about 3000 feet; April.

O. Periploca aphylla, Dene.

Common, but no specimens collected.

48. LOGANIACEÆ.

189. Buddleia crispa, Benth.

A large shrub, common on the sides of fields from near Badishkhél, through the whole Kuram valley, up to 7000 feet; not in the Hariáb district. Inflorescence very handsome.

49. GENTIANACEÆ.

354. Erythraea ramosissima, Pers., var. caspica, Fisch.

Very local. Shálizán, on sides of irrigation-channels in shade of rock; at Bíánkhél. A very slender plant with white flowers; July and August.

697. E. Centaurium, L.

Shálizán; June.

881. Gentiana aquatica, L. ?

Only one small specimen found, Bíánkhél; July.

932, 1003. G. sp.=61 of Jaeschke's collection in Lahul.

Síkarám, at 12,000 feet, on dry soil in the shelter of creeping juniper; Shéndtoi, at 10,000 feet, profuse.

876. Swertia petiolata, Royle.

Common at Bíánkhél and Sergal; July and August.

979. *Ophelia cordata*, *Don*.

Common at Shálizán and Shéndtoi ; August.

977. *O. cordata*, *Don*, var.

Alikhél to Bíánkhél ; August.

0. *O. Dalhousiana*, *Griseb.*

Shéndtoi, also in the vicinity of Shálizán along irrigation-streams, common ; August.

50 BORAGINÆÆ.

662. *Heliotropium europæum*, *L.*

Shálizán, in dry stony soil ; June.†

11. *H.* sp.

A very large single-flowered species, Alizai ; April.

864. *Trichodesma* sp.

A very handsome large blue-flowered species ; Alikhél.

197, 117, 106. *Omphalodes* sp. = *Griffith*, no. 564.

Common from Habíbkalla to Alikhél ; April and May.

900. *Cynoglossum furcatum*, *Wall.*

Habíbkalla ; July.

579. *C. glochidiatum*, *Wall.*

Kuram to Kaiwás ; April to July.

576. *Paracaryum anchusoides*, *Benth. & Hook. f.*

Hariáb district, common ; July.

0. *P. glochidiatum*, *Benth. & Hook. f.*

Shéndtoi gorge at 10,000 feet ; August.

0. *Echinosperrum barbatum*, *Lehm. ?*

At Zabardastkalla ; June.

198. *E. Lappula*, *L. ?*

Alikhél ; June.

0. *Eritrichium sericeum*, *Royle.*

From 11,000 to 13,000 feet, on rocks, Síkarám, Kaiwás ; July and August. A small plant with a very large turquoise-blue flower.

397. *Craniospermum parviflorum*, *Dcne.*

Very common at Kaiwás and Shéndtoi, from 9000 to 11,000 feet, in damp woods.

140. *Rochelia stellulata*, *Rchb.*

Shálizán, common amongst stones under bushes ; April.

145, 217. *Asperugo procumbens*, L.

A common field-weed from Badishkhél to Habíb-kalla; April.

507, 569, 858. *Anchusa Milleri*, Willd.

Hariáb district, Sergal and Bíánkhél; June, July.]

483, 230. *Nonnea nigricans*, DC.

Hariáb district to Karátígah; June, July.

136. *Lithospermum arvense*, L.

Sháлизán to Alikhél; May.

338. *L. officinale*, L.

Sháлизán; May.

0. *L. officinale*, L., var. = *L. erythrorhizon*, Sieb. & Zucc.

Sháлизán; May.

720. *Arnebia (Macrotomia) speciosa*, Aitchison et Hemsley, n. sp.

Perennis, tota planta hispido-pilosa, caulibus erectis usque ad bipedalibus simplicibus, foliis lineari-lanceolatis trinerviis, floribus densissime cymosis, cymis in racemum laxum elongatum dispositis, calycis segmentis primum corollam fere æquantibus fructiferis longe accrescentibus, nuculis maturis non visis.

Herba perennis, omnino longe hispido-pilosa (pili in vivis virides in siccis aurei), caulibus erectis simplicibus usque ad bipedalibus. *Folia* lineari-lanceolata; inferiora 6-10 poll. longa, 3-5 lineas lata; superiora gradatim breviora et basi rotundata, omnia prominente trinervata, obtusiuscula. *Flores* densissime cymosi, breviter pedicellati; cymæ 5-9-floræ, in racemum laxum distichum elongatum (6-12 poll.) dispositæ; calycis segmenta lineari-lanceolata, primum corollam fere æquantia, fructifera longe accrescentia usque sesquipollicaria; corolla hypocraterimorpha, 10-12 lineas longa, extus hirsuta, intus glabra, nuda, lobi breves rotundati. *Nuculæ* (maturæ) nobis ignotæ, abortu sæpe 1 vel 2, semiovatæ, dorso laminatæ, rugosæ.

Hills above Kaiwás, on exposed ridges from 9000 to 12,000 feet; July.

824, 498. *A. (Macrotomia) endochroma*, Hook. f. & Thoms.

On Síkarám and Serátígah, altitude 10,000 to 12,000 feet, on dry exposed soil. Employed as medicine by the natives.

28. *Oncosma echioides*, Sm.

Shinnak; April.

45, 235. *O.* sp. = 997 *Stocks*, = 530 *Griffith*.

From Shinnak to Kuram; April.

51. CONVULVULACEÆ.

989. *Ipomœa (Pharbitis) Nil*, Roth.

Common round villages, and may be a garden escape, Sháлизán; August.

40. *Calystegia* sp.

Bracts large, otherwise very like *Convolvulus arvensis*.

247, 299. *Convolvulus arvensis*, L.

A common weed of cultivation, Kuram and Shálizán.

348. *C. lineatus*, L. = *Griffith*, no. 676.

Common on stony ground from Kuram to Alikhél, growing very close against the ground.

15. *C.* sp. near *C. lanuginosus*, Desv., = nos. 408 & 72, Salt-range plants.

From Alizai to Habíbkalla, very characteristic over the open plains from 4000 to 6000 feet, in large raised very woolly patches, almost forming hummocks. (It is curious to notice that the white silky wool of this species, as also of others, and of *Buddleia crispa*, becomes a bronze-brown colour in the Herbarium.)

847. *C. pseudocantabrica*, Schrenck.

Common on the hills at Drékalla from 9000 to 10,000 feet; also Alikhél. The flowers in colour resemble those of *C. arvensis* exactly. July.

676. *Cuscuta Epithimum*, L. ?

On *Thymus Serpyllum*, L., at Shálizán; June.

654, 855. *C. planiflora*, Ten. ? = *Griffith*, no. 686.

From Shálizán to Káratigah, on *Perowskia atriplicifolia*, Bth.; June and July.

52. SOLANACEÆ.

861. *Solanum Dulcamara*, L.

Common in hedges at Zabardastkalla and Alikhél; July

0. *S. Melongena*, L.

Cultivated by the natives for the fruit, which is cooked as a vegetable.

314. *S. nigrum*, L.

Common from Kuram to Alikhél.

0. *S. tuberosum*, L.

The potato was not cultivated in the Kuram valley previous to 1879. It has been grown during the past year.

0. *Capsicum frutescens*, L.

Cultivated by the natives.

9. *Withania coagulans*, Dunal.

A very common shrub from Alizai to near Kuram.

766. *Atropa lutescens*, Jacq.

A large herbaceous perennial, very common in the Shéndtoi

ravine at 8000 feet, amongst shrubs and trees. The natives know it is poisonous.

624. *Datura Stramonium*, L.

Very common weed, villages from Thal to Shálizán; June. Known as poisonous.

481, 222. *Hyoscyamus niger*, L.

Very common in the Hariáb district in fields and villages, growing to 4 feet occasionally; June.

835. *H. pusillus*, L.

Common in the Hazárdarakht valley, Drékalla; July.

844. *H. reticulatus*, L.

At Drékalla, only one specimen; July.

988. *Nicotiana rustica*, L.

Cultivated at Shálizán. The only species found.

53. SCROPHULARINEÆ.

645, 440. *Verbascum erianthum*, Benth.

Very abundant on dry stony beds of mountain-streams, Kuram district, from 5000 to 7000 feet; June and July.

685. *V. Thapsus*, L.

Common everywhere up to 9000 feet in dry stony localities; June and July.

548. *Linaria venosa*, Lindl.

Alikhél, abundant in stony rocky soil; June and July.

264. *Scrophularia cabulica*, Benth.

From Badishkhél to Shálizán, not uncommon in clumps; April and May.

919. *S.* sp.

A dwarf species with extremely large flowers. Amongst rubble, at 12,000 to 14,000 feet, Síkarám; August.

461. *S.* sp. = *Griffith*, no. 618.

Common from Shéndtoi ravine to Péwárkotal and the Hariáb district; May and June.

811. *Wulfenia Amherstiana*, Benth.

Abundant on rocks in the Shéndtoi gorge and up the valleys of the Darban; July and August.

189. *Veronica agrestis*, L., var.

Habíbkalla.

0. *Veronica agrestis*, L.
Shálizán; May.
- 207, 213. *V. Anagallis*, L.
Kuram to Habíbkalla; April to June.
0. *V. bartsiaefolia*, Boiss.
Bíánkhél; June.
- 195, 664. *V. Beccabunga*, L.
Shálizán to Alikhél, abundant.
146. *V. biloba*, L.
Shálizán; April.
453. *V. biloba*, L., var.
Péwárkotal; June.
202. *V. campylopoda*, Boiss.
Alikhél; May.
763. *V. sp.* near *V. Teucrium*, var. *minor*, Trautv.
A very handsome large blue-flowered species, hanging in bunches from rocks, from a woody rootstock; Shéndtoi and Darban; July and August.
975. *Leptorhabdos sp.* near *L. virgata*, Benth. = *Griffith*, no. 594.
Profuse under trees in Alikhél forests; August.
990. *Euphrasia officinalis*, L.
Shéndtoi, at 9000 feet; August.
0. *Pedicularis gracilis*, Wall.
Shéndtoi, common from 9000 to 10,000 feet; August.
769. *P. Hookeriana*, Wall.
Shéndtoi, wet marshy soil. Flowers cherry-coloured with splashes of white.
796. *P. pectinata*, Wall.
Shéndtoi; July.
735. *P. pectinata*, Wall.?
Hills near Kaiwás.
0. *P. tenuirostris*, Benth.
Shéndtoi; August.
779. *P. sp.* = no. 200 of Jaeschke's Lahul collection.
Shéndtoi, in meadows, 10,000 to 11,000 feet; July.
487. *P. sp.* = no. 504 H of J. L. Stewart's Hazara collection.
Base of Síkarám, Sergal, and Karchátal, in pine-forests on dry hill-sides, very common; June.

54. OROBANCHACEÆ.

287. *Phelipæa ægyptiaca*, Walp.

Under large trees in the Shálizán orchards, very common; May.

934. *Orobanche* sp.=4088 Distrib. Herb. Griffith.

Very common on two species of *Artemisia*, Hariáb district; June. The stems are eaten before the flowers expand, and are rather nice, crisp, and cool, with little or no flavour.

 $\frac{934}{A}$. *O.* sp. With 934.
267, 893. *O.* sp.

At Bíánkhél on *Thymus Serpyllum*, common; July. Also at Shálizán in May.

55. ACANTHACEÆ.

908. *Strobilanthes alata*, Nees.

Very common at 7000 to 8000 feet in shaded moist localities, Shálizán, Darban, and Shéndtoi; July.

21. *Adhatoda Vasica*, Nees.

Shinnak to Badishkhél, a common shrub; April.

56. SELAGINEÆ.

94. *Gymnandra stolonifera*, Koch.

A small low herb that carpets the country in many localities with its lovely light-purple inflorescence (especially the "Mergs" on the Péwáarkotal, but also the encampment at Alikhél), from Kuram to Alikhél; April and May.

57. VERBENACEÆ.

41. *Lantana* sp. very near *L. alba*, L., but flowers much smaller.

Shinnak; April.

639. *Verbena officinalis*, L.

Common everywhere from Thal to the Kuram district up to 7000 feet; April to July.

58. LABIATÆ.

806. *Plectranthus rugosus*, Wall.

A common shrub round the fields of Shálizán and towards Shéndtoi river; July.

620. *Mentha incana*, Willd.

Common in ditches from Badishkhél to Alikhél; June to August.

911, 686. *Origanum normale*, Don.

Meadow-land near moisture; common at Kaiwás and Shálizán; July.

72, 157. *Thymus Serpyllum*, L.

Everywhere on the plains of Kuram up to 9000 feet, Hariáb district; April and May.

840, 239. *Micromeria biflora*, Benth.

Very common from Thal to Alikhél; April to June.

713. *Calamintha Clinopodium*, Benth.

Shálizán, Kaiwás, and Katskallé; June and July.

713
A. *C. sp.*545. *C. debilis*, Bunge.

Alikhél; June. This is a species from the Altai collected by Ledebour.

644. *Perowskia atriplicifolia*, Benth.

An extremely common shrub from Kuram and the Hariáb district to Káratígah. When in flower it is very handsome; flowers usually lavender-coloured, but occasionally pure white.

594. *Salvia glutinosa*, L.

Spreads everywhere, and in greatest luxuriance in dry water-courses amongst large stones. Flowers orange-yellow. A very sticky plant. June to August.

20, 56, 180. *S. Moorcroftiana*, Wall.

From Thal to Habíbkalla; very common on exposed open plains up to 7000 feet; April and May.

36. *S. plebeia*, Br.

Shinnak, common; April.

474. *S. rhytidea*, Benth.

Common from Kuram to Alikhél, and remarkable for its handsome purple flowers, often with a good deal of white.

480, 260. *Ziziphora clinopodioides*, L.

From Habíbkalla to Alikhél, very common. A very handsome plant, and extremely strongly scented with peppermint.

407. *Z. tenuior*, L.

A minute abundant annual, very sweetly scented; grows in the shade of other bushes; Hariáb district.

1201. *Nepeta* sp.
Serátígah from 10,000 to 11,000 feet; shrubby; July.
- 715, 768. *N.* sp.
Shálizán and Shéndtoi, very tall; July.
933. *N.* sp. = *Griffith*, no. 514.
Péwárkotal; August.
612. *N.* sp. = variety of 933.
Péwárkotal, in woods; June.
447. *N.* sp. near *N. teucriifolia*, *Willd.*
Hariáb district to Káratígah. A very handsome plant with large lavender flowers. Péwárkotal, edge of pine-forests, very common; May.
634. *N.* sp. = *Griffith*, no. 4060, *Kew distrib.*
Kaiwás and Shálizán; July.
0. *N. calaminthioides*, *Benth.*
A profuse field-weed near Shálizán; June.
0. *N. discolor*, *Royle.*
Síkarám, at 14,000 feet, abundant.
- 55, 588. *N. raphanorhiza*, *Benth.*
Amongst bushes in pine-forests, from Badishkhél to Alikhél, very common, and eaten by the natives. The bark of the root has the flavour of turnip, but the heart tastes like nice crisp filberts.
841. *N. rugosa*, *Benth.*
At Drékalla; July.
917. *N.* sp. near *N. rotundifolia*, *Benth.*
Amongst débris from 12,000 to 14,000 feet, Síkarám; August.
- 667, 625. *N.* sp.
Shálizán; June.
573. *Dracocephalum* sp. near *D. organoides*, *Steph.*, and *pinnatum*, *L.*
Bíánkhél, Síkarám, and Serátígah from 9000 to 12,000 feet; June to August.
- 529, 260. *Lallemantia Royleana*, *Benth.*
From Kuram to Alikhél; April to June.
273. *Scutellaria linearis*, *Benth.*
From Thal to Kuram and Shálizán; May and June.
201. *S.* sp.
From Habíbkalla to Péwárkotal and Alikhél; May.
537. *S.* sp.
Very common at Alikhél in stony exposed soil amongst scrub.

617. *Brunella vulgaris*, L.

Along water-channels and moist localities. Common from Kuram to Shálizán.

346. *Marrubium vulgare*, L.

From Hazárpírziárat to Alikhél, occasional.

695. *Stachys floccosa*, Benth.

Near Shálizán; June and July.

275. *S. parviflora*, Benth.

Excessively common from Thal to Kuram, and characteristic of the Kuram plains; May.

817. *S. sp.*

Near Serátigah; July.

623. *Leonurus Cardiaca*, L.

Common near Shálizán; June.

212. *Lamium amplexicaule*, L.

Very common in most places; Kuram district up to 7000 feet.

831. *L. rhomboideum*, Benth.

The foliage of this is very handsome, as are the fine large flowers. It grows in stony débris from 4 to 6 inches in height, and is remarkable for its velvet-like woolly leaves, varying in colour. Altitude from 13,000 to 15,000 feet, Serátigah and Síkarám.

777. *Phlomis bracteosa*, Royle.

Shéndtoi at 8000 feet, amongst shrubs; the only locality; July.

565. *P. cashmeriana*, Royle.

One of the most common and characteristic plants of the low scrub of the Hariáb district, and not uncommon in plains of Kuram district; flowers large, rose-coloured; June and July.

708, 749. *P. spectabilis*, Falc.

On the edge of forest, Péwáarkotal, and not uncommon in other places in the Kuram district at an altitude of 7000 to 8000 feet; July.

16. *Eremostachys sp.* = no. 103 P, J. L. Stewart's Peshaur collections.

A very handsome plant, with large yellow flowers. Alizai; April.

231. *E. sp.* May prove to be = 16.

Kuram; April.

486, 449. *Eremostachys speciosa*, *Rupr.* ?

Hariáb district only, in stony conglomerate soil; May and June. The large woolly yellow flowers in most cases grow directly from the base of the stock close to the ground.

615. *Teucrium Royleanum*, *Benth.*

A common weed around Shálizán and towards Shéndtoi; June.

147, 293. *Ajuga parviflora*, *Benth.*

Common between Shálizán and Habíbkalla; April and May.

27. *A. bracteosa*, *Benth.*

Shinnak; April.

59. PLANTAGINÆ.

179, 257. *Plantago lanceolata*, *L.*

Kuram district to 7000 feet; April.

516, 646. *P. major*, *L.*

Kuram and Hariáb districts, common; June.

MONOCHLAMYDEÆ.

60. ILLECEBRACEÆ.

585, 842. *Herniaria hirsuta*, *L.*

Hariáb district, common; June and July.

61. AMARANTACEÆ.

659. *Amarantus Blitum*, *L.*

Common on stony ground, Kuram district; June to August.

969. *A. frumentaceus*, *Roxb.* ?

On cultivated ground near Bíánkhél and Habíbkalla. I did not see it as a cultivated crop.

62. CHENOPODIACEÆ.

0. *Chenopodium album*, *L.*

Common at Shálizán.

879. *C. album*, *L.*, var. *candicans*, *Moq.* = *Griffith*, no. 1741.

Bíánkhél; July.

891. *C. album*, *L.*, var.

Bíánkhél to Péwárkotal; July.

750, 899. *C. Botrys*, *L.*

Common, Kuram and Hariáb districts; a field-weed much collected and eaten as a vegetable, cooked; July.

980. *Chenopodium murale*, L.

Shálizán ; August.

491. *C.* sp.

Sikarám, at 10,000 feet.

577. *Blitum virgatum*, L.

Common, Kuram and Hariáb districts, but more especially so in forests of the Hariáb district where wood has been burnt ; June and July.

63. POLYGONACEÆ.

767. *Polygonum amplexicaule*, Don.

Shéndtoi, abundant at 10,000 feet ; July.

315. *P. aviculare*, L.

Shálizán ; May.

0. *P. aviculare*, L., var.

Péwarkotal ; August.

656. *P. Bellardi*, All., var. *β. patulum*, Meissn.

Shálizán ; June.

657. *P. Convolvulus*, L.

Fields, Shálizán ; June.

0. *P. dumetorum*, L.

Fields, Shálizán ; June.

866. *P. glabrum*, Willd.

Fields, Shálizán ; July.

986. *P. nepalense*, Meissn.

Shálizán ; August.

215. *P. paronychioides*, C. A. Mey.

Everywhere at 5000 to 8000 feet ; May.

1203. *P. perforatum*, Meissn.

Sikarám, at 12,000 feet.

794. *P. rumicifolium*, Royle.

Shéndtoi, at 10,000 feet, and up to nearly 12,000 feet amongst rhododendron and juniper, common. In Kashmir the young stems are eaten cooked.

816. *P. (Avicularia) biaristatum*, Aitchison et Hemsley, n. sp. Suffruticosum, prostratum, glabrum, ramis tortuosis, foliis parvis confertis subcoriaceis ellipticis, ochreis amplis bifidis longe biaristatis, floribus polygamis axillaribus solitariis binis sessilibus vel breviter pedicellatis.

Suffrutex glaber, omnino prostratus, contorte ramosus, ramis sæpe brevibus. *Folia* conferta, sessilia vel in petiolum brevissimum attenuata, sub-

coriacea, elliptica vel obovata, 2-4 lineas longa, sæpe abrupte breviterque acuminata; ochreæ amplæ, bifidæ, longe biaristatæ. *Flores* rubri, polygami, axillares, solitarii vel bini, sessiles vel breviter pedicellati, 1-2 lineas diametro; perianthium 5-partitum; segmenta similia et subcar-nosa vel 2 interiora tenuiora; stamina 8; filamenta basi dilatata; ova-rium glabrum; styli teretes. *Nux* triquetra.

A very distinct species. Serátígah, at 12,000 feet; a dense woody miniature shrub.

655, 632. *Polygonum* sp.

Sháлизán; June.

791, 952. *Rheum Moorcroftianum*, Wall.

Very common above 10,000 to 14,000 feet, from Shéndtoi westward to Serátígah.

539. *R. Ribes*, L.

From 8500 to 11,000 feet on the hills along the Hazárdarakht river. Eaten by the natives, and preferred by them to *R. Moorcroftianum*, although this is also eaten; they chew the raw stems as they travel.

465, 827, 940. *Oxyria reniformis*, Hook.

Common on all the hills at 10,000 to 13,000 feet, from Shéndtoi to Serátígah; July and August.

705. *Rumex nepalensis*, Wall.

Kaiwás; July.

1202. *R. orientalis*, Bernh.

Fields near Sergal, very common; August.

611. *R.* sp.

Péwárkotal, in woods; June.

302. *R.* sp.

Sháлизán; May.

64. THYMELACEÆ.

10. *Daphne oleoides*, L.

From Hazarpírziárat, the Kuram, and Hariáb districts up to 11,000 feet in dry localities. As already stated, this, with *Sophora mollis* and *Cotoneaster nummulariæfolia*, are to be met everywhere forming part of the scrub. Camels will not eat this shrub except when very hungry. It is poisonous, producing violent diarrhœa. I feel certain that much of the mortality of camels in the Kuram division was due to the prevalence of this shrub. It was noticeable when camels were grazing that the *Daphne* was not touched until all the other scrub had been eaten.

668. *Thymelæa arvensis*, Lamk.

Very common near the Shálizán cantonments amongst small shingle along watercourses; June.

638. *Wikstroemia virgata*, Meissn.

A very common shrub east of Péwárkotal at about 8000 feet, near moisture; June and July.

519. *Diarthron carinatum*, Jaub. & Spach.

From Shálizán westward along the whole Hariáb; June and July.

65. ELÆAGNACEÆ.

22, 261. *Elæagnus angustifolia*, L.

From Shinnak to Alikhél. A cultivated tree with a large fruit, certainly not wild in Afghanistan.

288. *E. parvifolia*, Wall.

In the low-hill scrub near Shálizán up the Darban and Shéndtoi streams; quite wild, as in Kashmir, but also cultivated.

1204. *E. angustifolia*, L., var.

A tall tree cultivated for its long racemes of strongly scented flowers, which come out before the leaves. Shálizán; June.

524. *Hippophaë rhamnoides*, L.

Employed for hedges in the Hariáb district near Bíánkhél. I have not collected it in a wild state.

66. LORANTHACEÆ.

48, 87. *Viscum album*, L.

Commonly on olive at Badishkhél and Darwazaghai pass; on *Quercus Ilex* at the base of the Péwárkotal; not seen on any of the other trees on which it grows in Kashmir.

607. *V. articulatum*, Burm.

On *Quercus Ilex* at the base of Péwárkotal; June. Also common at Murree on the same tree.

67. SANTALACEÆ.

339. *Thesium divaricatum*, Jan.

Shálizán, common on dry stony hot soil amongst *Peganum* and *Cleome*; May.

68. EUPHOBIACEÆ.

71. *Euphorbia Chamæsyce*, L.

Shálizán; June.

553. *Euphorbia falcata*, L.

Abundant in fields near Alikhél; June.

159. *E. Gerardiana*, Jacq.?

Shálizán, a field-weed; April.

558. *E. Szovitzii*, Fisch. & Mey.

Abundant in stony places near Alikhél; June.

380. *E. sp.* = my Kashmir collection, no. 94.

On the hills amongst shrubs at the limit of trees, 10,000 to 12,000 feet; June to August. Involucre large, very handsome, bright yellow.

520, 605. *E. sp.* = Griffith, nos. 352 and 415; related to *E. cornuta*, Pers.

Very common in dry clay-fields, Alikhél and Bíánkhél.

70, 177. *E. sp.* = Griffith's *Distribution* 4898.

Kuram district; April and May.

43. *E. sp.*

Shinnak; April. Involucre bright orange.

250, 274. *Andrachne telephioides*, L.

Shálizán and Kaiwás, not uncommon in stony ground; April.

Ricinus communis, L.

Cultivated in gardens at Shálizán. Near Thal it is quite wild, as also in the hills near Attock.

69. URTICACEÆ.

677. *Ulmus campestris*, Sm. var.

A large tree in the woods at 7000 to 9000 feet; not common. Well known to the natives, by whom the wood is much used, chiefly in making platters and small bowls.

403. *U. sp.*

Probably only a variety of *U. campestris*, but the leaves are much smaller; no flower or fruit seen. It is a more common but smaller tree than 677. The wood is used for the same purposes.

158, 349. *Celtis caucasica*, Willd.

Usually a cultivated tree near shrines and graveyards from Thal to the base of the Péwárkotal, but also quite wild on the lower hills along the Darban and Shéndtoi ravines; not seen in the Hariáb district. Under cultivation it has occasionally a very large trunk.

692. *Cannabis sativa*, L.

Kuram district and Shálizán, common. Is known by the natives to yield an intoxicating drug, though not employed by them. June.

364. *Morus alba*, L.

A cultivated tree in and near all gardens &c. in the Kuram district from Thal westward. I do not think I ever saw it in the Kuram district indigenous, but I may have overlooked it.

345, 13. *Ficus caricoides*, Roxb. = *virgata*, Roxb.

A small tree, or large shrub from Alizai to the Kuram district up to 6000 feet, usually near cultivation; April. Not seen in Hariáb.

305. *F. Carica*, L.

Most probably an escape from cultivation. Sides of water-courses and fields near the shelter of trees &c.; May.

223. *Urtica dioica*, L.

Habíbkalla; June.

458. *U. dioica*, L., var.

Shéndtoi; May.

1204, 1205, 1206, 716. *U. dioica*, L., var.543. *Parietaria debilis*, Forst.

In clefts of rocks at Alikhél and Hariáb district; not seen in Kuram; June.

542. *P. officinalis*, L.

In rocks, common, Kuram and Hariáb districts; June.

70. PLATANACEÆ.

50, 259. *Platanus orientalis*, L.

Not indigenous, but largely cultivated from Hazárpírziárat through the whole Kuram district. Only in one locality near Shálizán can I say it is naturalized, and, curiously enough, it is working up hill, where several trees of various sizes, mostly with very short trunks and stunted branches, may be seen. I noticed a similar fact in Kashmir on the western aspect of the Takht í Súlimán. In neither instance are there any signs of cultivation or of irrigation near where these higher trees are growing, nor could there ever have been, on account of the precipitous nature of the country.

71. JUGLANDACEÆ.

378. *Juglans regia*, L.

A cultivated tree in the Kuram district, very occasional at 7200 feet in the Hariáb. It occurs wild in the Shéndtoi and Darban ravines from 7000 to 9000 feet, but not in the Hariáb district. The walnut-groves of Shálizán surpass any thing of the sort I ever have seen; the trees average from 12 feet in circumference, and one is 17 feet, with splendid timber.

72. CUPULIFERÆ.

719. *Betula Bhojpatra*, Wall.

To the east of Sikárám at 11,000 feet, not common. The bark is not employed by the Afghans for any purpose, at least in this district.

25, 128, 87, 262. *Quercus Ilex*, L.

Common everywhere from 6500 to 9000 feet in the Kuram and Hariáb districts. Used largely as fodder for cattle, and the branches for fences and wattling houses; as fuel it burns fairly, even when green.

394. *Q. semecarpifolia*, Wall.

A large forest tree. I measured one 18 feet in circumference, with the trunk 100 feet before it divided. This had been cut down by the Afghan army just previous to our occupation of the Kuram district. Common from 9000 feet to the limits of trees (11,000 feet), in the Hariáb as well as Kuram district. The leaves afford good fodder for goats.

73. SALICINÆ.

49, 64, 365, 39. *Salix acmophylla*, Boiss.

Sadatkalla and Shálizán; April and May. Badishkhél; April. A large cultivated tree; but I found it in localities near Shálizán, where I doubted its being in cultivation.

111. *S. angustifolia*, Willd.

Alikhél; April. A large shrub, quite wild, and also cultivated round fields.

413. *S. elegans*, Wall.

A large shrub, just above the limits of trees, from 11,000 to 12,000 feet, Shéndtoi; July.

389. *Salix grisea*, Wall. = *Griffith*, nos. 1318 and 1319.

Shéndtoi, from 10,000 to 12,000 feet, common.

1208. *S. daphnoides*, Vill.

One specimen collected by Major Collett, Kuram valley (locality unknown).

574. *S. pycnostachys*, Anders.

A cultivated tree near the village of Ballút; no male flowers found.

$\frac{389}{A}$ *S. pycnostachys*, Anders.

Male flowers collected in Shéndtoi at 11,000 feet; May.

1207. *S. sp.* = *Griffith*, no. 1316.

Referred to by Brandis (For. Flor. p. 464) as a form between *S. Safsaf*, Forsk., and *S. acmophylla*, Boiss.

99. *S. sp.* near *S. seriocarpa*, Anders., and *S. babylonica*, L.

A large cultivated tree, with weeping branches; the young branches cut as fodder for cattle. Very common at Alikhél round fields, where it is planted to keep open the irrigation channels.

246. *S. sp.* near *S. babylonica*, L.

A large weeping tree cultivated at Kuram; April.

110. *S. sp.* near *S. viminalis*, L.

A shrub, wild and cultivated round fields for basket-work, and known as the "true willow" ("Asíl-á-walla").

254. *Populus alba*, L.

A cultivated tree near villages, very common in the Kuram district; occasional at Hariáb as at Alikhél.

350. *P. alba*, var. *denudata*.

A cultivated tree, with the same range as 254.

161. *P. nigra*, L., var. *afghanica*, Aitchison et Hemsley. Ramulis ultimis gracillimis, foliis parvis membranaceis ovato-rhomboides basi insigniter cuneatis, amentis femineis laxis gracilibus.

Arbor 100-pedalis, ramis adscendentibus, ramulis ultimis gracillimis. *Folia* graciliter petiolata, primum puberula, adulta membranacea, ovato-rhomboides, lamina sæpissime 1-1½-pollicaris, raro 1¼-pollicaris, basi sæpissime longe cuneata, apice breviter acuminata, margine crenato-denticulata; petiolus filiformis, usque ad pollicaris. *Amenta* feminea breviter pedunculata, bipollicaria, gracilia, laxa; perianthium cupulatum, obsolete lobatum, majusculum; capsula immatura ovata, pedicello subæquilonga.

With all the principal characters of *P. nigra* this has exceedingly slender branches, small leaves, and slender female catkins.

Possibly it may prove a distinct species; but in the absence of very complete materials we have not ventured to give it that rank. A large tree, fully 100 feet in height and 8 feet in girth; quite wild, also cultivated in the vicinity of Shálizán, but only at one shrine. In the Hariáb district it is common, cultivated, and apparently wild also; in fruit May.

74. GNETACEÆ.

126. *Ephedra* sp.

Alikhél, on rocks; April.

1209. *E.* sp.

Near Shálizán; June.

75. CONIFERÆ.

0. *Cupressus sempervirens*, L.

One celebrated tree, cultivated at a shrine near Shálizán, is 6 feet in circumference at 4 feet from the ground. No other seen in the country.

412. *Juniperus communis*, L.

On the hills above the limit of trees from 11,000 to 13,000 feet; from the hills behind Shálizán westwards to Serátígah; May and June.

114. *Juniperus excelsa*, Wall.

A very large tree, forming fully half the forests at 9000 feet in the Hariáb district; does not extend to the east of the Gandháo stream, except one or two cultivated spaces in a garden, or rather orchard, near the Shálizán cantonments. The bark exfoliates in long fibrous strips, which are collected and employed by the natives for making pads for carrying their water-jars on and for other similar purposes.

1210. *J.* sp. near *J. recurva*, Ham.

Síkarám, at 10,000 to 12,000 feet; August.

59. *Taxus baccata*, L.

As far west as the Gandháo stream and no further; occurs in the inner villages at 7500 to 9000 feet, where there is moisture.

171. *Pinus excelsa*, Wall.

This occurs as a fine tree from 8000 to 11,000 feet, but is met with occasionally as low as 7000 feet, and as a bush up to 12,000 feet in certain localities; in the hills of the Kuram district west-

wards to Serátigah along the whole range and spurs at the above altitude. To it is given the name "Nuhktár," a term applied to *Pinus longifolia* further west, of which I have not seen a single specimen. From Kohát *viâ* Thal to Serátigah.

113. *Pinus Gerardiana*, Wall.

A very handsome tree that does not branch as pines usually do, the trunk and branches being more like those of a well-formed oak. It is easily recognized at a distance by its nearly white ash-grey bark, which on close examination is seen not to be of one colour, but consists of patches of all tints, from light green to autumnal reds and brown; this is due to the peculiar way the bark exfoliates. It occurs from 7000 to 11,000 feet in the Hariáb district, but is unknown in the Kuram district, or as far north as the Péwárkotal, or its union with the base of Síkarám. It is a common pine in Kóst. The nuts are a large article of diet amongst the villagers of the district in which the pine grows, and a luxury in N.W. India. The Kuram valley heretofore has not exported the nuts; those that reached Kohát were chiefly from the Kóst country.

127. *Cedrus Deodara*, Roxb.

A superb forest-tree from 7500 to 10,000 feet. Commences at the Spíngháo stream and covers the hills to the west of this, none, as far as I have seen, to the east, except an occasional tree in the Gandháo stream. I measured a tree 22 feet in circumference that must have been fully 150 feet high. It is curious to note that trees here all more or less run to trunk; the branches scarcely afford timber at all; and this is specially remarkable in the Hazárdarakht river, where the branches are extremely short and very small in calibre.

170, 785. *Abies Smithiana*, Wall.

A large tree, from 8000 to 10,000 feet, sometimes up to nearly 12,000 feet, struggling with *Pinus excelsa* for existence. Throughout the whole of the forests from the Kuram district to Serátigah; but in the Hariáb district, where it is extremely dry, it occurs rather more commonly at 9000 to 11,000 feet.

172. *A. Webbiana*, Wall.

A fine tree, at 8000 to 11,000 feet, in the forests of the Kuram and Hariáb districts; usually restricted to the ridges of the hills, always so in the Hariáb district.

MONOCOTYLEDONES.

76. PALMACEÆ.

0. *Chamærops Ritchieana*, Griff.

This occurs as a very stunted shrub in the conglomerate stony country to the north of the Kuram river, near Badishkhél. To the south of the river, from the Darwazaghai Pass to Hazárpírziárat, it grows in great luxuriance, and covers miles of the alluvial plains with a dense thicket. The fibre obtained by merely breaking the leaf is the usual material for rope in the Kuram and Hariáb districts. The leaves are made into baskets and mats.

77. AROIDEÆ.

776. *Arisæma abbreviatum*, Schott.

Common in hot exposed localities amongst stones at the very exit of the Shéndtoi river from the hills opposite Katskallé, ascending to 7000 feet.

125. *Arum Griffithii*, Schott.

Common under shrubs with *Anemone biflora*, from Kuram to Alikhél; April and May.

78. JUNCAGINACEÆ.

867. *Potamogeton oblongus*, Viv.

In rice-fields from Kuram to Alikhél; July.

79. ALISMACEÆ.

882. *Triglochin palustre*, L.

In moist meadows near Bíánkhél; July.

652, 619. *Alisma Plantago*, L.

Rice-fields, Shálizán, very common; July.

869. *Sagittaria sagittifolia*, L.

Rice-fields, common, Shálizán; July.

80. ORCHIDACEÆ.

570. *Orchis latifolia*, L.

In meadow-land from 7000 to 9500 feet, at heads of springs; common from the Shéndtoi to Síkarám and Alikhél; June to August.

780. *Goodyera repens*, *R. Br.*

Shéndtoi, from 9000 to 10,000 feet, in pine-forest; July. A common Gulmerg (Kashmir) species.

1238. *Liparis* sp.

Shéndtoi, in damp grassy spots from 9000 to 10,000 feet. In fruit only.

322. *Peristylus* sp.

Sháлизán, on the sides of irrigation-channels amongst grass and ferns under shade of rocks; altitude 7000 feet; May. Flowers green.

253. *Epipactis veratrifolia*, *Boiss.*

Between Sháлизán and Habíbkalla, along the low hills near springs; May and June. Flowers very handsome, orange, with green-yellow spots.

442. *Cephalanthera ensifolia*, *Rich.*

From 8000 to 9500 feet, at Péwárkotal and on hills along Shéndtoi; under trees, common; May.

439. *C.* sp.

Abundant under oak trees (*Quercus Ilex*) along the base of the Péwárkotal, at 6000 to 6500 feet; in fruit only; May.

81. IRIDACEÆ.

105. *Ixiolirion montanum*, *Herbert.*

From near Kuram to Habíbkalla, very common in some fields, but not general; April.

71. *Xiphion Stocksii*, *Baker.*

Very common in conglomerate soil from Badishkhél to Kuram, thence less so, and again very common in similar soil in the Hariáb district up to nearly 9000 feet.

227. *Iris ensata*, *Thunb.*

At Kuram near the river, common; April.

423. *I. Gúldenstædtiana*, *Lepech.*

In quantity on the hills above Sháлизán at 7000 feet, amongst grass near water-channels. Flowers nearly white, with a slightly primrose-yellow tinge.

1239. *I. pallida*, *Lamk.*

Cultivated in gardens, Sháлизán; May.

46. *Moræa Sisyrinchium*, *Ker.*

Very profuse in clay-fields near Badishkhél, and is, I think, the same plant of which I sent large quantities of bulbs from Kohát to Saháranpore.

82. DIOSCOREACEÆ.

332. *Dioscorea deltoides*, Wall.

In the low-hill scrub from 7000 to 8000 feet, near Shálizán; not found in Hariáb.

83. SMILACEÆ.

701. *Smilax vaginalis*, Dcne.

In the low scrub in the interior of the hills near Shálizán, from 7000 to 8000 feet, very common.

84. LILIACEÆ.

228. *Allium capitellatum*, Boiss.?

A very small-flowered species at Kuram; April.

191. *A. Griffithianum*, Boiss.

From Kuram to Habíbkalla; April.

845. *A. neapolitanum*, Cyr.?

Only two large white, very handsome heads, collected near Drékalla; July.

503. *A. robustum*, Kar. & Kir.

West base of Síkarám at 9000 feet, Sergal river; June.

734. *A. sp.* near *A. senescens*, L.

It differs from the latter, a well-known Siberian species, by its more exerted stamens.

523. *A. umbilicatum*, Boiss.

Abundant in fields at Bíánkhél; June.

115 (ex parte). *Gagea filiformis*, Ker?

Alikhél; April.

115 (ex parte). *G. lutea*, Ker.

In the Péwár woods and meadows; April and May.

190, 255. *G. reticulata*, Ræm. & Schul.

From Kuram to Habíbkalla; April and May.

104. *G. setifolia*, Baker, n. sp. *Bulbus* parvus, globosus, tunicis multis siccis vestitus, fibris radicalibus multis flexuosis. *Folium* proprium radicale, semper solitarium, subulatum, glabrum, 3-6-pollicare. *Scapus* glaber, $\frac{1}{2}$ -3 poll. *Flores* 2-4, umbellati, bracteis 3 coarctatis, centrali 1-1 $\frac{1}{2}$ lin. lata, reliquis anguste linearibus, pedicellis brevibus vel elongatis glabris vel leviter albo-puberulis. *Perianthium* 4 lin. longum, segmentis lanceolatis acutis facie luteis dorso læte viridibus. *Stamina* perianthio paulo breviora, antheris lineari-oblongis 1-1 $\frac{1}{2}$ lin. longis.

A small species, marked in the monophyllous group by its subu-

late leaves. No. 103 may be a depauperated form of the same plant; it has smaller flowers, narrower leaves and bracts, the primary bract placed often some distance on the peduncle below the inflorescence. At Alikhél; April.

103. *Gagea setifolia*, Baker, var.

Alikhél; April.

1241. *G. thesioides*, Fisch. The type and a bulbiferous variety.

Common at Alikhél and Péwárkotal.

596. *Eremurus* (*Henningia*) *Aitchisoni*, Baker, n. sp. *Fibræ* radicales cylindricæ, interdum semipedales, 4-5 lin. diam. *Folia* exteriora squamæformia, membranacea, deltoidea, alba, lineis brunneis pluribus distinctis longitudinalibus percursa; interiora propria 6-12, linearia vel lanceolata, sesquipedalia, 6-21 lin. lata, glabra, deorsum medio fistulosa. *Scapus* teres, strictus, glaber, 3-4-pedalis. *Racemus* densus, floriferus subpedalis, expansus 2 poll. diam., fructiferus sesquipedalis et ultra, pedicellis strictis erecto-patentibus 9-15 lin. longis, bracteis magnis lineari-subulatis complicatis albis brunneo vittatis ciliatis. *Perianthium* infundibulare, pallide rubellum, segmentis oblanceolatis obtusis brunneo vittatis 1-1½ lin. latis. *Stamina* declinata, perianthio paulo breviora, antheris luteis subglobosis. *Stylus* filiformis, falcatus, longe exsertus, 8-9 lin. longis. *Capsula* globoso-trigona, 5-6 lin. diam., seminibus in loculo circiter 3 triquetris angulis angustissime alatis.

A very fine plant, of which the nearest ally is *E. robustus*, Regel, of Turkestan, which has lately been introduced into cultivation. Karchátal and at Drékalla, on ridges of the hills from 11,000 to 12,000 feet, common; June.

100, 544. *E. aurantiacus*, Baker.

This was described from a single indifferent specimen gathered by Griffith. Dr. Aitchison has got a fine suite of specimens, showing both flower and seed. It does not belong to the section *Henningia*, as was supposed, the fully-developed stamens being twice as long as the reflexing segments of the perianth. The capsule is globose-trigonal, about ½ inch in diameter, with 2-3 narrowly winged dull-brown triquetrous seeds in each cell. In the Hariáb district from 7000 to 9000 feet; one of the most common plants on rough stony ground. Alikhél; April; not seen in the Kuram district. The leaves largely used as a vegetable cooked. Flowers golden yellow.

96. *Fritillaria imperialis*, L.

Amongst rocks and stones in the Hariáb district, common from 7000 to 9000 feet. Flowers a deep brick-red.

1240. *Tulipa chrysantha*, Boiss.

I doubt this being distinct from *T. stellata*, Hooker; there are intermediate forms. This is a high-altitude form; the higher the plant goes, the more yellow and dwarf it becomes. I have seen the bulbs as woolly in the plains of the Punjab as any of these at 9000 feet, where the species is common.

40. *T. stellata*, Hook. Typical form.

Common from Badishkhél to Kuram; April.

62, 63. *T. stellata*, Hook., var.

Sadatkalla; April. Flowers bright yellow, outer segments more or less flushed with dark red on the back.

736, 918, 799. *Lilium polyphyllum*, Don, var.

Occasional on the hills from 11,000 to 12,000 feet, growing through the midst of juniper bushes, &c.; only one or two specimens found in each locality; Shéndtoi, Kaiwás, and Sikarám; July and August. Flowers not more than half as long as in the form figured by Elwes, much more tinted with claret-purple, the segments reflexing from halfway down, the bulb shorter with more numerous scales, and the capsule not more than half as long.

536. *Asparagus brachyphyllus*, Turcz.

At Alikhél and Shálizán; June.

14. *A. capitatus*, Baker, var.

Alizai. The young shoots are eaten.

327. *A. trichophyllus*, Bunge.

Round Shálizán, very common; May.

809. *Polygonatum multiflorum*, All

Shéndtoi; July.

741. *P. verticillatum*, All.

The Darban and Shéndtoi ravines, altitude 8000 feet. The large roots are much sought after and eaten.

730, 737. *P. verticillatum*, All., var. *gracile*, Baker.

"Small slender form; leaves below the summit of the stem not more than two or three to a whorl." Under high rocks and, if any thing, of a higher altitude than 741 (to 11,000 feet). The roots are also very different

26. *Merendera persica*, Boiss.

From Kuram to Péwárkotal and meadows on the Spíngháo;

common at Hariáb. Flowers as the snow melts. Most of the flower-buds have on their external surface a slight purplish tinge, which is quite lost on the expansion of the flower. This plant extends to the Salt range, and as far south as Rawul Pindee and Thelum.

85. JUNCACEÆ.

603. *Juncus compressus*, L.

Moist meadow-land near Bíánkhél; June.

370, 678. *J. glaucus*, Ehrh.

Kuram and Hariáb districts, from 6000 feet, common; July and August.

578. *J. glaucus*, Ehrh. var.?

Bíánkhél; June.

86. CYPERACEÆ.

(Named by Dr. O. Boeckeler.)

684. *Cyperus longus*, L.

Common in rice-fields, Shálizán; June.

964. *C. flavescens*, L.

In glades near springs of water near Péwáarkotal; August.

868. *Scirpus maritimus*, L., var.

In rice-fields round Shálizán, in profusion; July.

965. *S. setaceus*, L.

In the same localities as 964, in glades at Péwáarkotal.

34, 601, 235. *Heleocharis palustris*, R. Br., var.

Shinnak, Kuram, and Bíánkhél; April to June.

745, 410. *Kobresia scirpina*, Willd.

Kaiwás and Shéndtoi, from 11,000 to 12,000 feet; May to July.

358. *Schoenus nigricans*, L.

Common near springs in loamy soil.

571. *Carex* sp.

Meadow-land near Bíánkhél; June.

1242. *C. Oliveri*, Boeck. MSS.

Bíánkhel.

1243. *C. alpina*, Sw.

Shéndtoi, at 11,000 feet; August.

418. *Carex cardiolepis*, *Nees*.
Shálizán, sides of fields, profuse ; May.
1244. *C. cardiolepis*, *Nees*, var.
Katskallé, in dry localities, very common ; May.
1007. *C. hirtella*, *Drej*.
Shéndtoi, common at 11,000 feet ; August.
602. *C. nutans*, *Hochst*.
Bíánkhél, common ; June.
724. *C. sempervirens*, *Vill.*, var.
Common on hills north of Kaiwás ; July.
33. *C. hirta*, *J.*, var.
Shinnak ; April.
501. *C. vulgaris*, *L*.
At the west base of Sikarám in moist grassy mould at 10,000 feet.
818. *C. divisa*, *L*.
Serátigah, at 10,000 feet, not common ; July.
- 313, 508. *C. Aitchisoni*, *Boeck. MSS.*
Shálizán, Sergal, Bíánkhél, common from 6000 to 8000 feet ; May and June.
- 92, 194, 493. *C. stenophylla*, *Wahlenb.*
West base of Sikarám, Alikhél, and Túrai, from 7000 to 10,000 feet, common ; April to June.
870. *C. sp.*
Shálizán ; June.

87. GRAMINEÆ.

(Named for me by the late General Munro.)

0. *Oryza sativa*, *L*.
Kuram and Hariáb districts, very largely cultivated up to 7500 feet.
1245. *Zea Mays*, *L*.
Cultivated up to 9000 feet, or nearly so, all through the country. The specimens in my herbarium were from Sergal, altitude 8750 feet, where no irrigation could be used and the fields were dependent upon rain ; August.]
66. *Alopecurus agrestis*, *L*.
A common weed in old rice-fields, Kuram ; April.

527, 196. *Piptatherum angustifolium*, *Munro, MSS.*

Common in pine-woods, Bíánkhél, Alikhél; May.

430. *P. cærulescens*, *Pal. de Beauv.*

Sháлизán, in fields, common; May.

328. *P. sp.*

Sháлизán, in moist soil; May.

723. *P. sp.*, probably a state of No. 328.

Hills north of Kaiwás; July.

444. *P. sp.* near 328 and 723.

Common under trees, Péwárkotal.

891. *P. sp.* near *P. holciforme* and *P. molinioides*.

Péwárkotal; July.

947. *P. laterale*, *Munro in Herb. Griff.?*

On dry localities, Sikarám, at 12,000 feet.

896. *P. sp.*

Common at Péwárkotal.

1250. *Panicum miliaceum*, *L.*

Cultivated largely in the Hariáb district, and also in the higher fields of the Kuram district up to nearly 9000 feet.

843. *P. (Echinochloa) Crus-galli*, *L.*

Very common in rice-fields and damp clay soil, Hariáb district; July and August.

1247. *P. (Echinochloa) Crus-galli*, *L.*, var.

A very luxuriant grass in rice-fields, overtopping the rice; from Kuram to Hariáb district, common; August.

985. *Digitaria sanguinalis*, *Scop.*

Sháлизán, common in sides of fields; August.

1248. *Setaria viridis*, *Pal. de Beauv.*

Sháлизán, common on hot stony soil; June.

870. *S. glauca*, *Pal. de Beauv.*

Sháлизán, in fields, common; July.

1249, 680. *S. italica*, *Kunth.*

Cultivated very extensively in the Hariáb district, in one or two localities almost to 9500 feet; also in the Kuram district chiefly at the higher localities.

892. *S. italica*, *Kunth*, var.

Cultivated fields.

904. *Gymnothrix flaccida*, *Munro*, var.

Fields round Sháлизán and road-sides, common; July.

1246. *Pennisetum orientale*, Pers.

Shálizán ; June.

890. *Lasiagrostis* sp. near *L. splendens*, Kunth.

From Kaiwás to Péwárkotal ; July.

775. *L. Jacquemontii*, Munro (*Stipa Jacquemontii*, Jaub.).

Shéndtoi at 8000 feet ; July.

445. *Stipa pennata*, L.

On exposed limestone rocks, Péwárkotal, common at 8500 feet ;
Bíánkhél, Alikhél, common in dry pine-forests.

753, 897. *S. sibirica*, L.

Everywhere from 7000 to 9000 feet, chiefly under the shade of trees, in small tussocks. This grass is well known to be poisonous to animals here, as in Kashmir. Scarcely present in the Hariáb district, but extends to Péwárkotal and its vicinity.

1252. *Agrostis* sp. near *A. ciliata*. "I believe an undescribed species, awned."—Munro.

Shéndtoi, 11,000 feet ; August.

1253. *A.* sp. near *A. verticillata*, Vill. "A common Afghan plant,"
Munro.

Shéndtoi, profuse in fields ; August.

885. *A. alba*, L.

Fields at Bíánkhél, common.

889. *Polypogon littoralis*, Sm.

On road-sides, common in the Hariáb district ; July.

648. *P.* sp. near *P. littoralis*, Sm.

Shálizán ; June.

832. *P. monspeliensis*, Desf.

Along streams from Drékalla to Káratígah, at 9000 feet ;
July.

689, 758. *Calamagrostis* sp. "I cannot distinguish it from *C. lanceolata* = Griffith's *Journal*, no. 441."—Munro.

Shálizán to Katskallé, on sides of fields ; July.

887. *C. lanceolata*, Roth.

From Péwárkotal to Bíánkhél, common in wet places ; July.

1251. *Deyeuxia* sp. near *D. varia*, Kunth. "I have never seen any specimens previously from India ; perhaps a new species."—Munro.

From 9000 to 11,000 feet, Shéndtoi and Síkarám ; August.

347. *Arundo Donax*, L.

In the vicinity of Kuram, common round fields and at the river. Frequently cultivated on graves and at holy shrines.

757. *Cynodon Dactylon*, Pers.

Kuram district, common; July.

277. *Chloris villosa*, Pers.

Common between Kuram and Shálizán, on shingle; May.

367. *Avena oligostachya*, Munro, MSS. "Certainly a good new species."

A curious grass, hanging in tufts from the clefts of the limestone and slate rocks of the Shéndtoi gorge, at from 7000 to 8000 feet.

24, 175. *A. fatua*, L.

Common throughout the fields from Shinnak to Habíbkalla. Weeded out from the corn and given as fodder to cattle before it is ripe. When ripe, its hairy seed is said to be hurtful to animals.

405, 497. *Poa* sp. near *P. laevis*, R. Br.

West base of Síkarám from 9000 to 10,000 feet, in pine-forests, also Shéndtoi; May.

647. *P. trivialis*, L.

Shálizán, common; June.

308. *P.* sp. near *P. trivialis*, L.

Shálizán; May.

295. *P.* sp. near *P. trivialis*, L.

Shálizán; May.

927. *P. bulbosa*, L.?

Shálizán, at 10,000 feet; August.

151. *P. bulbosa*, L.?, var. *vivipara*.

Habíbkalla and Shálizán, common; April.

931. *P. laxa*, Haenk.?

Síkarám, from 11,000 to 13,000 feet; August.

946. *P. flexuosa*?

At Síkarám, 12,000 feet; August.

905. *Eragrostis poaeoides*, Pal. de Beauv., var.?

Shálizán, common in cultivated fields; July.

1257. *Melica* "sp. unknown to me," Munro.

Shéndtoi, above 9000 feet, common; August.

321. *M. Jacquemontii*, Dcne., var. *albans*.

At the roots of bushes near Shálizán; May.

1258. *Melica Jacquemontii*, *Dcne.*, var. *purpurea*.
Péwarkotal ; August.
- 590, 958. *Koeleria cristata*, *Pers.*, var. *glaberrima*.
Common in fields at Karchátal, altitude 13,000 feet, in June,
and at Síkarám in August.
1258. *K. phleoides*, *Pers.*
Kuram to Shálizán ; May.
1256. *Festuca duriuscula*, *L.*, var. *violacea*. "Collected by Griffith,
summit of Kohbába, 14,500 feet."
Síkarám, 13,000 feet ; August.
949. *F. ovina*, *L.*
Síkarám, common at 12,000 feet.
429. *F. elatior*, *L.*
Shálizán, common in fields ; May.
424. *F. elatior*, *L.*, var. *minor*.
Fields, Shálizán, common ; May.
962. *Brachypodium tataricum*, *Munro*.
Sergal and Síkarám, amongst rocks and large stones, from 10,000
to 14,000 feet ; August.
568. *Bromus Danthoniæ*, *Trin.*
Profuse at Alikhél ; June.
1006. *B. sp.* near *B. asper*, *L.*
Shéndtoi, profuse from 11,000 to 12,000 feet ; August.
755. *B. sp.* near *B. asper*, *L.*
In large tussocks, Shálizán and Kaiwás ; July.
1254. *B. sp.* near *B. erectus*, *Huds.*
Síkarám, from 10,000 to 12,000 feet, common ; August.
928. *B. sp.* near *B. erectus*, *Huds.*
Síkarám, at 12,000 feet, amongst stones.
814. *B. sp.* near *B. erectus*, *Huds.*
"Flowers few, spicules glabrous." Serátígah, at 9000 feet ; July.
1255. *B. sp.*
Síkarám, from 11,000 to 13,000 feet ; August.
- 270, 187. *B. sp.* near *B. squarrosus*, *L.*
Common amongst stones, Kuram, Shálizán, and Habíbkalla ;
May.
837. *Lolium perenne*, *L.*
Fields, Káratígah ; July.

1261. *Lolium perenne*, *L.*, var. *aristata*.

Fields, Karchátal; June.

426. *L. temulentum*, *L.*

Very common in fields amongst the corn, in Hariáb and Kuram districts; May. It is considered poisonous, producing narcotic symptoms. Called "Mashta."

705. *Agropyrum* sp. near *A. semicostatum*, *Nees*.

Fields near Kaiwás; July.

803, 903. *A. semicostatum*, *Nees*.

Near Shálizán, Shéndtoi, and Síkarám, from 11,000 to 12,000 feet; July and August.

1259. *A. repens*, *Ræm. & Schul.*

Zabardastkalla; July.

886. *A. repens*, *Ræm. & Schul.*, var. *minor*.

Common in fields, Bíánkhél; July.

561. *A. orientale*, *Ræm. & Schul.* = *Griffith*, no. 413.

At Alikhél, amongst stones, very profuse; June.

310. *Secale cereale*, *L.*

Occurs nearly solely in wheat-fields, and is considered a weed, not being purposely sown along with the wheat. In some fields it almost eradicates the wheat-crop. It is considered to have injurious properties when eaten as food. Shálizán, common weed in the Kuram and Hariáb districts; May.

754. *Elymus excelsus*, *Turcz.*

On damp embankments at 7500 feet, Shálizán and Kaiwás; July.

438. *Hordeum vulgare*, *L.*, var.

An escape, having been carried by birds or rats to the localities where it was found. Largely cultivated in the Kuram district, less so in the Hariáb district.

815. *H. caducum*, *Munro*.

Karatígah and Serátígah, from 9000 to 11,000 feet.

285, 316, 265. *H. murinum*, *L.*

On stony ground, from Kuram to Shálizán; April, May, and June.

1260. *H. hexastichum*, *L.*

Extensively cultivated, Kuram district; June.

560. *Ægilops caudata*, *L.*

Alikhél, amongst stones, very common; June.

981. *Saccharum spontaneum*, *L.*?
Shálizán, waste ground near fields; August.
71. *S.* sp. near *S. Griffithii*, Munro, MSS.
Kuram and Shálizán in dry waste courses; a large coarse grass;
May.
1262. *Anthistiria anathera*, *Nees*.
Shálizán, fields, common; August.
336. *Imperata cylindracea*, *Cyr*.
Shálizán, in moist ground bordering fields, very common; June.
- 1, 432. *Andropogon* sp.
Mandúrí, Shálizán, and Habíbka, common on dry stony soil;
April. Lemon-scented.
756. *A. punctatus*, *Roxb.*
Sides of fields near Shálizán; July.
849. *Ischæmum hirtinodes*, *Munro, MSS.*
Drékalla, common at 9000 feet; July.

ACOTYLEDONES.

88. FILICES.

783. *Woodsia hyperborea*, *R. Br.*
Shéndtoi, amongst rocks at 10,500 feet; July.
- 408, 771, 609, 823. *Cystopteris fragilis*, *Bernh.*
The common fern in the lateral valleys of Kuram district, altitude 9000 feet; not in the Hariáb district except at an elevation of 11,000 feet; Síkarám, common altitude 11,000 to 13,000 feet.
1263. *C. fragilis*, *Bernh.*, var. *dentata*, *Hook.*
Shéndtoi; May.
74. *Adiantum Capillus-Veneris*, *L.*
Common near Kuram; April.
1264. *A. venustum*, *Don.*
Common in woods at 7000 feet from Shálizán to Kaiwás.
1265. *A. æthiopicum*, *L.*
Common on damp rocks and water-channels near Shálizán. This is new to the Himalayan region; it is found in the Neilgherries.
787. *Cryptogramma crispa*, *R. Br.*
Shéndtoi, on rocks from 9000 to 11,000 feet, common; July.

391. *Asplenium septentrionale*, Hoffm.
Shéndtoi, from 7000 to 11,000 feet.
374. *A. Ruta-muraria*, L.
From Shéndtoi westward, on the rocks of the Hariáb district.
407. *A. viride*, Huds.
Shéndtoi, 9000 to 11,000 feet, very common.
411. *A. Trichomanes*, L.
Shéndtoi, altitude 7000 to 9000 feet.
409. *A. varians*, Hook. & Grev.
Shéndtoi.
- 1266, 371. *A. fontanum*, Bernh.
Shéndtoi and Síkarám, at 11,000 feet; August.
122. *A. Ceterach*, L.
Hariáb, only one locality, on rocks near Alikhél.
1010. *Aspidium Prescottianum*, Hook.
Shéndtoi, altitude 9000 to 10,000 feet, amongst stones, not common.
1009. *Nephrodium barbigerum*, Hook., var.
"This is a form between *barbigerum* and *Brunonianum*; they should doubtless be regarded as one species."—*Baker*. Shéndtoi, 9500 to 10,000 feet altitude.
790. *N. rigidum*, Desv.
This establishes beyond question *rigidum* as an Afghan species. A doubtful plant was gathered by Griffith.
- 788, 764. *N. rigidum*, Desv., var.
A very large, compound, broad-fronded form.
- 455, 384. *N. rigidum*, var. = *Griffith's plant*.
Doubtful between *N. rigidum* and *N. Filix-mas*.
All the above *Nephrodia* collected in the Shéndtoi ravine from 9000 to 11,000 feet in July and August.
382. *Polypodium Dryopteris*, L.
Shéndtoi, profuse under rocks, May.
798. *P. clathratum*, C. B. Clarke.
Shéndtoi and Kaiwás at 11,000 feet, very common; July and August.
1002. *Botrychium Lunaria*, Sw.
Shéndtoi, from 9000 to 10,000 feet, amongst grass, profuse.

89. LYCOPODIACEÆ.

369. *Selaginella sanguinolenta*, *Spreng.*

Shéndtoi range, from 7000 to 9000 feet, on rocks in great luxuriance. This is new to the Himalaya, being known before from Siberia and Kamschatka.

90. EQUISETACEÆ.

30, 320. *Equisetum elongatum*, *Willd.*

Shinnak and Shálizán, at 4000 to 7000 feet; April and May.

91. MUSCI.

950. *Bartramia fontana*, *L.*

West base of Sikarám near spring of water, at 11,000 feet, along with *Orchis*, *Codonopsis*, *Ophelia*, &c.

368. *Hypnum* sp. near *H. cupressiforme*.

Shéndtoi; May.

92. FUNGI.

1267. *Morchella conica*, *Pers.*

Appearing as the snow melts in the Shéndtoi gorge, 7000 feet; common under bushes.

Agaricus campestris, *L.*

Kuram district, common at 6000 feet.

Helvella crispa, *Fr.*

Common in the Shéndtoi ravine, from 7000 to 9000 feet; end of July. Eaten by the natives.

Hydnum coralloides, *Scop.*

Shéndtoi, at the limit of trees (11,000 feet) on rotten wood, growing from its surface like large masses of sponge, and not, as commonly in Kashmir, suspended from the upper part of the hollows of trees. Eaten by the natives. Collected end of August.

On Indian Begonias. By C. B. CLARKE, M.A., F.L.S.

[Read December 4, 1879.]

(PLATES I.—III.)

THE present paper is supplementary to the account of the Indian Begonias in Sir J. D. Hooker's 'Flora of British India,' ii. 635–656; but although principally confined to Indian species, I have also looked over all the species of the Order in the Kew Herbarium. The Order comprises two genera of one species each, viz. *Hillebrandia* and *Begoniella*; and about 350 other species are referred to the genus *Begonia* in Bth. & Hook. Gen. Pl. i. 841. It is with the general principles on which these species are to be arranged that the present paper deals.

Alph. DeCandolle, Prodr. xv. pt. i. 267–408, divides them into 3 genera, viz. *Mezierea*, *Casparya*, and *Begonia*. *Mezierea* (3 species) is separated only by the ovary being "before flowering unilocular;" but Hk. f. remarks that, in the two Indian species, the placentation nowise differs from that of *Begonia*. I have found (in numerous examinations of fresh specimens) that the placenta do not quite meet in the young ovary, but the fruit is completely 2-celled (Pl. III. figs. 33, 34); these two Indian *Meziereas* are therefore *Begonias* of the section *Platycentrum* or very near thereto. It is clear that A. DC. possessed insufficient material of these species; for he discarded Wallich's original specific name of *gigantea* as absurd ("nam inter Begoniaceas minime gigantea"); it really is the largest among the 64 Indian species.

A. DC.'s other genus *Casparya* comprised 14 South-American and 4 Javan species; it was separated from *Begonia* by the character that the capsule dehisces dorsally, exactly up the angles or wings, and not, as often as in *Begonia*, by elliptic lines on the faces. To this genus A. DC. doubtfully appended 3 (of which 2 were one) Indian species, remarking that their place was doubtful because the dehiscence of their capsule was unknown. Their fruit is now found to be baccate indehiscent, as stated by Hk. f. as one of the reasons why he abandons both the genus *Casparya* and the dehiscence of the fruit as a primary character in dividing *Begonia*. Hk. f. also states that he has found in one species the capsule dehiscing sometimes along the angles, sometimes along its faces; this I have never been able to see. In Bth. and Hk. f. Gen. Pl., therefore, Klotsch's plan is followed in the main; the styles with the complication of their stigmas and the stamens

are employed as characters of primary value, while the dehiscence of the capsule is altogether passed by. I have been unable to attach high importance to the characters of the styles and stamens; while, by paying attention to the dehiscence of the capsule, I have thrown the whole mass of *Begonia* into six subgenera which appear to me eminently natural.

The following tables represent the arrangement of the Indian species, the essential sectional characters being more especially referred to.

Subgenus I. *CASPARYA*. Fruit 4- (3-)celled, indehiscent, or in *B. Roxburghii* irregularly subdehiscent at the angles. Stout plants with stout fruits. Placentæ bifid. Fruits round, or angular, or horned, but not with any thin papery wing.

1. *B. ROXBURGHII*, *A. DC.* Fruit 4-celled, 4-angled, with very thick walls, succulent, ultimately deliquescent.—Fig. 1.

2. *B. TESSERICARPA*, *C. B. Clarke.* Only known from Griffith's No. 2586; differs from *B. Roxburghii* by the less succulent, more leathery fruit.—Fig. 2.

3. *B. SILHETENSIS*, *C. B. Clarke.* Fruit 4-celled, ellipsoid, with very thick walls, almost woody. Fruit figured from Griffith No. 2569.—Fig. 3. The placentæ are not known, and this species is perhaps altogether remote from *Casparya*.

4. *B. INFLATA*, *C. B. Clarke.* Fruit 3-celled, with a slender rib down the back of each cell, leathery. Fruit figured from Griffith No. 2587.—Fig. 4.

5. *B. DUX*, *C. B. Clarke.* Fruit unknown (arranged here by the habit only).

Subgenus II. *PARVIBEGONIA* (character widened). Capsule 2- (3-)celled, indehiscent. Slender herbs with slender capsules, the walls whereof are papery, breaking up irregularly. Placentæ bifid, and sometimes simple.

Section A. Ovary and capsule 2-celled. Capsule with three wings, whereof one is often larger than the others. The two faces adjacent to the broader wing have no mesial line, *i. e.* they have no septum attached to their middle within.

6. *B. VERTICILLATA*, *Hook. f.*—Fig. 5.

7. *B. PROLIFERA*, *A. DC.*—Fig. 6.

8. *B. PALEACEA*, *Kurz*. Capsule not seen by me ; perhaps not of this place.

9. *B. SINUATA*, *Wall.*—Fig. 7.

10. *B. ANDAMENSIS*, *Parish.*—Fig. 8.

11. *B. MAETABANICA*, *A. DC.* Capsule nearly as in that of *B. andamensis*.

12. *B. PARISHII*, *C. B. Clarke*. Capsule not seen by me; perhaps not of this place.

13. *B. FLACCIDISSIMA*, *Kurz*. Capsule not seen by me ; perhaps not of this place.

14. *B. CRENATA*, *Dryander*. This is placed by A. DC. in a separate section, *Dysmorphia*, characterized by the wings being more irregular and much produced below the cells of the fruit ; but I can find no real difference in this respect between *Dysmorphia* and several species placed by A. DC. in *Parvibegonia* and *Monophyllon*.—Fig. 9.

15. *B. CANABANA*, *Miq.* Capsule nearly as in *B. crenata*.

Sect. B. Ovary and capsule 3-celled. Capsule wingless, with a slender rib down the centre of each face corresponding to the septum there attached within.

16. *B. DELICATULA*, *Parish.*—Fig. 10.

Subgenus III. *ALÆCIDA*. Capsule 3-celled, with produced herbaceous (not papery) angles, dehiscing exactly down the centre of the back of each cell by a single line. Small plants, with small flowers and capsules. Capsules, when looked down upon from above, appearing stellately 3-rayed with six stellate ribs. These species alone, of the Indian Begonia, have the character A. DC. gives *Casparya* ; but they widely differ, according to nature, from the species arranged in *Casparya* by A. DC. ; and I therefore thought it better to leave the name *Casparya* where it was than to apply it to these minute species.—The whole of the material for this section was supplied from Burma by Mr. Parish, who also has supplied the greater part of the new species of *Begonia* described in the 'Flora of British India.' He sent excellent specimens, generally exhibiting both flowers and fruits, often accompanied by beautiful coloured pictures from the living plant. I am sorry that I was obliged to pass by most of the specific names

Mr. Parish had given them, as he unfortunately gave them generally trivial names, forgetting that in such a genus as *Begonia* names like *rosea*, *pulchella*, &c. were sure to be preoccupied.

17. *B. ALECIDATA*, *C. B. Clarke*.—Fig. 11.

18. *B. TRICUSPIDATA*, *C. B. Clarke*.—Fig. 12.

19. *B. TRIRADIATA*, *C. B. Clarke*. Capsule nearly as that of *B. tricuspidata*.

Subgenus IV. *ASCHISMA*. Capsule 3-celled, with three papery wings, dehiscing by an elliptic line round each of the three faces. Placentæ undivided. Each of the three faces of the capsule is attached internally down its mesial line to the septum; the elliptic valve (as it appears from without) cannot therefore fall off till the septum ultimately tears off from the axis, or till the two halves of the valve tear away from the septum; it therefore opens round a narrow slit only at first.—This subgenus comprises species very different in habit and in the size of the capsule, and may perhaps admit of further division; but the Indian species in it are few and easily distinguishable by trivial characters.

20. *B. FIBROSA*, *C. B. Clarke*.—Fig. 13.

21. *B. TENERA*, *Dryander*.—Fig. 14.

22. *B. SUBPELTATA*, *Wight*. Capsule nearly the same as that of *B. tenera*.

23. *B. CONCANENSIS*, *A. DC.*—Fig. 15.

24. *B. TRICHOCARPA*, *Dalz.*—Fig. 16.

25. *B. NIVEA*, *Parish*.—Fig. 17.

26. *B. ALBO-COCCINEA*, *Hook.*—Fig. 18.

27. *B. FLOCCIFERA*, *Bedd.*—Fig. 19.

28. *B. BRANDISIANA*, *Kurz.*—Fig. 20.

29. *B. WALLICHIANA*, *A. DC.* A very doubtful plant.

30. *B. MALABARICA*, *Lamk.* Capsule nearly as that of *B. albo-coccinea*, fig. 18, varying in the degree of the angularity of the shoulders of the wings.

Subgenus V. *EU-BEGONIA*. Capsule 3-celled, with three papery wings, dehiscing by an elliptic line round all of the three faces. Placentæ bifid. One wing often much larger than the others.

The three faces of the capsule are attached by their mesial line (prominent from without) to the septa, and therefore do not fall away till at a very late stage the septa themselves tear from the axis, or they break in two halves from the septum.

31. *B. PICTA*, *Smith.*—Fig. 21.

32. *B. SATRAPIS*, *C. B. Clarke.* Capsule not well ripe, promises to be nearly as that of *B. picta*.

33. *B. EVANSIANA*, *Andr.* A doubtful Indian plant.

34. *B. JOSEPHI*, *A. DC.*—Fig. 22.

35. *B. PEDUNCULOSA*, *Wall.*—Fig. 23.

36. *B. SURCULIGERA*, *Kurz.*—Fig. 24.

37. *B. MODESTIFLORA*, *Kurz.*—Fig. 25.

38. *B. PARVULIFLORA*, *A. DC.*—Fig. 26.

39. *B. GEMMIPARA*, *Hook. f.*—Fig. 27.

40. *B. CORDIFOLIA*, *Thwaites.*—Fig. 28.

41. *B. AMENA*, *Wall.*—Fig. 29.

42. *B. SCUTATA*, *Wall.*—Fig. 30.

43. *B. OVATIFOLIA*, *A. DC.*—Fig. 31.

44. *B. SUBPERFOLIATA*, *Parish.*—Fig. 32.

45. *B. MOULMEINENSIS*, *C. B. Clarke.* Fruit not seen; placed with the last from general resemblance only.

46. *B. FALLAX*, *A. DC.* Only exists on the authority of Wight's figure and A. DC.'s description; for the example of it in Wight's own herbarium is *B. malabarica*.

Subgenus VI. *PLATYCENTRUM*. Capsule 2-celled, 3-winged, dehiscent on one or on all three faces. Placentæ bifid. Two wings much narrower than the third (sometimes subobsolete), including a narrower face between them. Narrow face with a mesial line denoting the line of attachment of one septum within; the lateral two broader faces without any mesial line, because the second septum is attached next to the broad wing.

Sect. *a.* *ELASTICÆ*. Capsule dehiscing by an elliptic line round the narrow face, the two broader faces indehiscent. The narrow face early opens out from the base, the septum to which it is attached breaking in the middle of the lower part of the

capsule and often subelastically carrying the placentæ with it outside.

47. *B. GIGANTEA*, *Wall.*—Fig. 33.

48. *B. EPISCOPALIS*, *C. B. Clarke.*—Fig. 34.

Sect. *b.* EU-PLATYCENTRUM. Capsule dehiscing by an elliptic line round the narrow face; and also *simultaneously* by a line on each of the broad faces adjacent to the narrow wings. Not rarely this line is ultimately continued into a complete ellipse on each of the broad faces, which then, being quite free, fall off as valves.

This section appears at first sight sharply separable from the *Elasticæ*; but the first species, *B. xanthina*, is in fact almost intermediate between Sect. *a* and *b*; and in this species, too, the narrow face is inclined to split out entirely from below as in *B. gigantea*.

49. *B. XANTHINA*, *Hook.*—Fig. 35.

50. *B. RUBRO-VENIA*, *Hook.*—Fig. 36.

51. *B. LACINIATA*, *Roxb.*—Fig. 37.

52. *B. BARBATA*, *Wall.*

53. *B. MEGAPTERA*, *A. DC.*

54. *B. SIKKIMENSIS*, *A. DC.*

55. *B. CATHCARTII*, *Hook. f.*

56. *B. THOMSONII*, *A. DC.*

57. *B. GRIFFITHII*, *Hook.*

58. *B. REX*, *Putzeys.*

} Capsule in all nearly as in *B. rubro-venia* or *B. laciniata*.

59. *B. BREVICAULIS*, *A. DC.*—Fig. 38.

60. *B. INTEGRIFOLIA*, *Dalz.*—Fig. 39.

61. *B. GUTTATA*, *Wall.* Capsule nearly as in *B. integrifolia*.

62. *B. PROCRIDIFOLIA*, *Wall.*

63. *B. GONIOTIS*, *C. B. Clarke.*—Fig. 40.

64. *B. SANDALIFOLIA*, *C. B. Clarke.*—Fig. 41.

The foregoing account of the Indian Begonias will be found to differ from that in the 'Flora of British India' in one point, viz. the statements regarding the dehiscence of the capsule. In the typical species with three cells to the capsule, I describe the "de-

hisence" as taking place round elliptic lines on the faces of the capsule within the ribs; the faces I consider not caducous, as they only tear off long after the ripe seeds have been scattered, and then the faces with the septa usually break from the axis, leaving the broken down capsule as a mere skeleton consisting of the three persistent ribs, with the fragments of the axis and the placentæ in the centre. Sir J. D. Hooker not considering that the dehiscence and the final breaking down of the capsule can be definitely distinguished, this character has been sunk in the account of *Begonia* in the 'Flora of British India.'

EXPLANATION OF THE PLATES.

N.B. The figures are enlarged 2 diameters except where otherwise stated.

PLATE I.

- Fig. 1. *Begonia Roxburghii*, A. DC. *a.* Fruit (pendent), succulent. *b.* Horizontal section of fruit; plane passing through the line * showing the placentæ but not the seeds. *c.* Seed, rich brown; the margins of the cells of the testa slightly raised, $\times 25$ diameters.
2. *B. tessericarpa*, C. B. Clarke. *a.* Fruit (leathery). *b.* Outline of an imaginary horizontal section; plane passing through the line *
3. *B. silhetensis*, C. B. Clarke. *a.* Fruit, woody. *b.* Horizontal section of fruit (the examples do not show whether the placentas are single or double); plane passing through the line *
4. *B. inflata*, C. B. Clarke. *a.* Fruit, leathery. *b.* Horizontal section of fruit; plane passing through the line *; showing the placentæ but not the seeds. *c.* Seed, rich brown; the margins of the cells of the testa slightly raised, $\times 25$ diam.
5. *B. verticillata*, Hook. *a.* Capsule, dehiscent by the irregular breaking up of the papery faces of the carpels. *b.* Seed, brown, the margins of the areolæ of the testa beaded by reason of the microscopical papillæ, $\times 25$ diam.
6. *B. prolifera*, A. DC. *a.* Capsule, nearly as in *B. verticillata*. *b.* Seed, brown; margins of the areolæ of the testa slightly raised, not beaded, $\times 25$ diam.
7. *B. sinuata*, Wall. *a.* Capsule. *b.* Horizontal section of capsule; plane passing through the line * . . . ; placentæ shown, seeds not shown.
8. *B. andamensis*, Parish. Capsule nearly as in *B. sinuata*.
9. *B. crenata*, Dryander. *a.* Capsule. *b.* Horizontal section of capsule; plane passing through the line *; placentæ shown, seeds not shown.
10. *B. delicatula*, Parish. *a.* Capsule (subdorsally dehiscent). *b.* Horizontal section of capsule; seeds not shown. *c.* Seed, brown, $\times 25$ diam.
11. *B. alacida*, C. B. Clarke. *a.* Fruit, half-ripe, from the side. *b.* Horizontal section of half-ripe fruit; plane passing through the line *; placentas shown, but not the seeds. *c.* Dehiscent fruit looked down

upon from above (green, not papery). *d.* Seed, rich brown; margins of the areoles of the testa slightly raised, $\times 25$ diam.

- Fig. 12. *B. tricuspidata*, C. B. Clarke. *a.* Fruit, from the side. *b.* Dehiscing fruit, looked down upon from above.
13. *B. fibrosa*, C. B. Clarke. *a.* Capsule, from one of the broad faces. *b.* Capsule, from the narrow face. *c.* Horizontal section of dehiscing capsule; plane passing through the line * . . . ; seeds not shown. *d.* Seed, brown, $\times 25$ diam.
14. *B. tenera*, Dryander. Capsule (wings subequal).
15. *B. concanensis*, A. DC. Capsule.
16. *B. trichocarpa*, Dalz. Capsule.
17. *B. nivea*, Parish. Capsule.

PLATE II.

- Fig. 18. *B. albo-coccinea*, Hook. Capsule.
19. *B. floccifera*, Bedd. Capsule.
20. *B. Brandisiana*, Kurz. *a.* Capsule. *b.* Section of capsule horizontally; plane through the line *
21. *B. picta*, Smith. *a.* Capsule, dehiscing round an elliptic line on each face. *b.* Horizontal section of dehiscing capsule; plane passing through the line * . . . ; placentæ shown, seeds not shown. *c.* Seed, fine, brown; margins of the areoles of the testa slightly raised, $\times 25$ diam.
22. *B. Josephi*, A. DC. *a.* Capsule, dehiscing round an elliptic line on each face. *b.* Horizontal section of dehiscing capsule; plane passing through line * . . . ; placentæ shown, not the seeds.
23. *B. pedunculosa*, Wall. Capsule, dehiscing round an elliptic line on each face.
24. *B. surculigera*, Kurz. Capsule, dehiscing round an elliptic line on each face.
25. *B. modestiflora*, Kurz. Capsule, dehiscing round an elliptic line on each face.
26. *B. parvuliflora*, A. DC. Capsule, dehiscing round an elliptic line on each face.
27. *P. gemmipara*, Hook. *f.* *a.* Capsule, dehiscing round an elliptic line on each face. *b.* Seed, not quite ripe, $\times 25$ diam. *c.* Seed, quite ripe; the adpressed papillæ gone or very obscure, the testa slightly glandular or with remains of the papillæ, $\times 25$ diam.
28. *B. cordifolia*, Thwaites. Capsule, dehiscing round an elliptic line on each face.
29. *B. amœna*, Wall. *a.* Capsule, dehiscing round an elliptic line on each face. *b.* Seed, yellow-brown; margins of the areoles slightly raised and beaded, $\times 25$ diam.
30. *B. scutata*, Wall. Capsule, dehiscing round an elliptic line on each face.

PLATE III.

- Fig. 31. *B. ovatifolia*, A. DC. Capsule, dehiscing round an elliptic line on each face.

- Fig. 32. *B. subperfoliata*, Parish. Capsule dehiscing round an elliptic line on each face.
33. *B. gigantea*, Wall. *a.* Capsule, dehiscing along a narrow ellipse on the face between the narrow wings only; the other faces indehiscent; the elliptic piece splits out elastically from the base, carrying the placentæ with it. *b.* Horizontal section of the dehiscing capsule; plane passing through the line * *c.* Similar horizontal section of the capsule made just before dehiscence; placentæ shown, seeds not shown. *d.* Seed, brown-yellow, $\times 25$ diam.
34. *B. episcopalis*, C. B. Clarke. *a.* Capsule, dehiscing by a narrow elliptic line on the face between the narrow wings only, the elliptic piece not yet split out. *b.* Horizontal section of the dehiscing capsule; plane passing through the line *
35. *B. xanthina*, Hook. *a.* Capsule, dehiscing along a narrow ellipse on the face between the two shorter wings only. *b.* Horizontal section of the capsule; plane passing through the line *; placentæ shown, seeds not shown.
36. *B. rubro-venia*, Hook. *a.* Capsule, dehiscing along a narrow ellipse on the face between the two shorter wings, and also simultaneously by a single line on each of the other faces close to the narrow wing. *b.* Horizontal section of the capsule; placentæ shown, seeds not shown. Ultimately the two lateral faces dehisce *completely*; not being attached by the septa they flake out as at *c*, which is the same horizontal section as *b* in the latest stage. *d.* Seed, yellow-brown, $\times 25$ diam.
37. *B. laciniata*, Roxb. Capsule dehiscing; dehiscence exactly as in *B. rubro-venia*.
38. *B. brevicaulis*, A. DC. From A. DC.'s type specimen. Capsule dehiscing just as in *laciniata*.
N.B. All the capsules between 51. *laciniata* and 59. *brevicaulis* are like *laciniata* or *rubro-venia*, differing a little in shape and hairiness.
39. *B. integrifolia*, Dalz. Capsule, dehiscing exactly as in *B. rubro-venia*, &c.
40. *B. goniotis*, C. B. Clarke. Capsule, dehiscing as in *B. rubro-venia*.
41. *B. sandalifolia*, C. B. Clarke. Capsule, dehiscing as in *B. rubro-venia*.

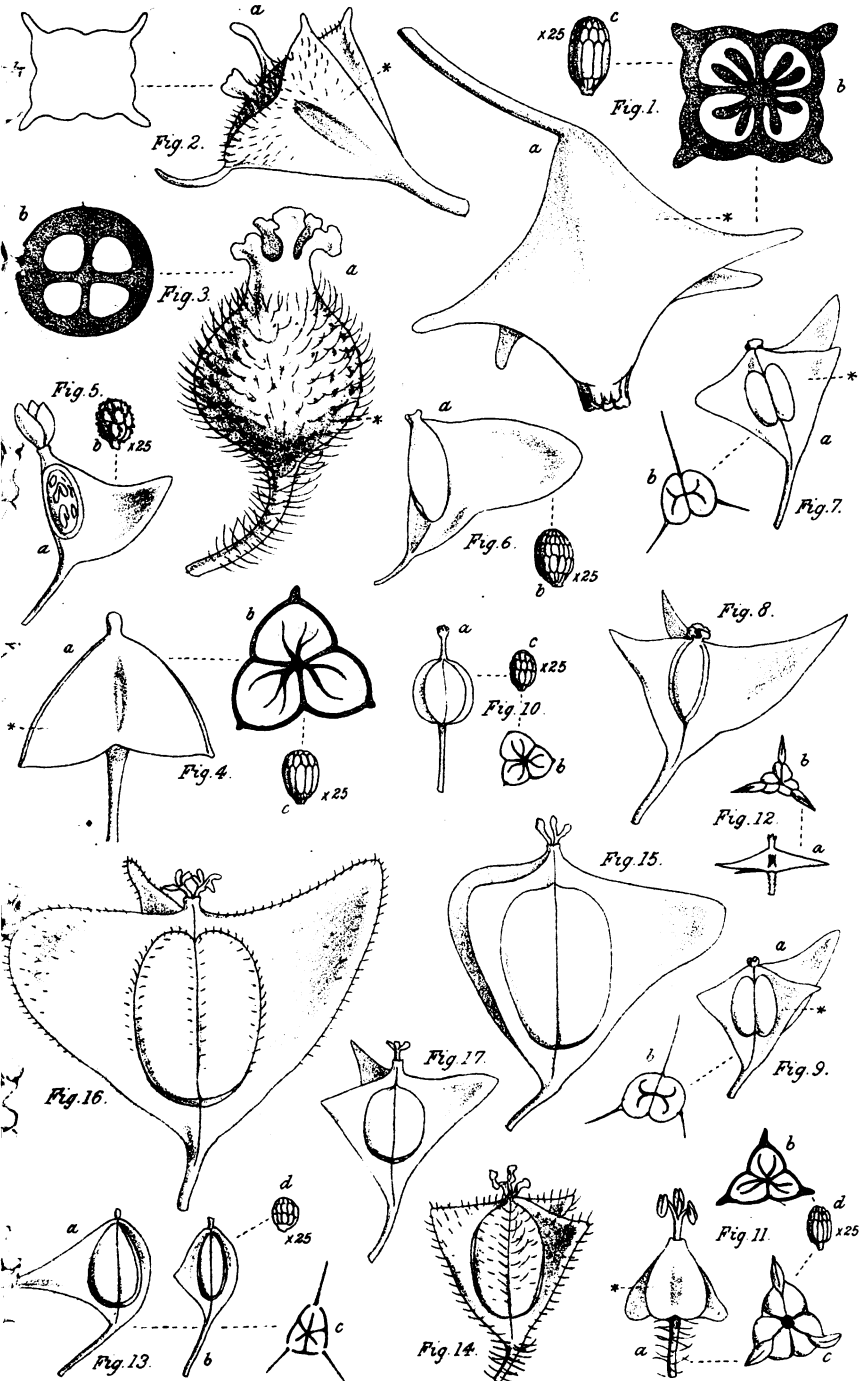

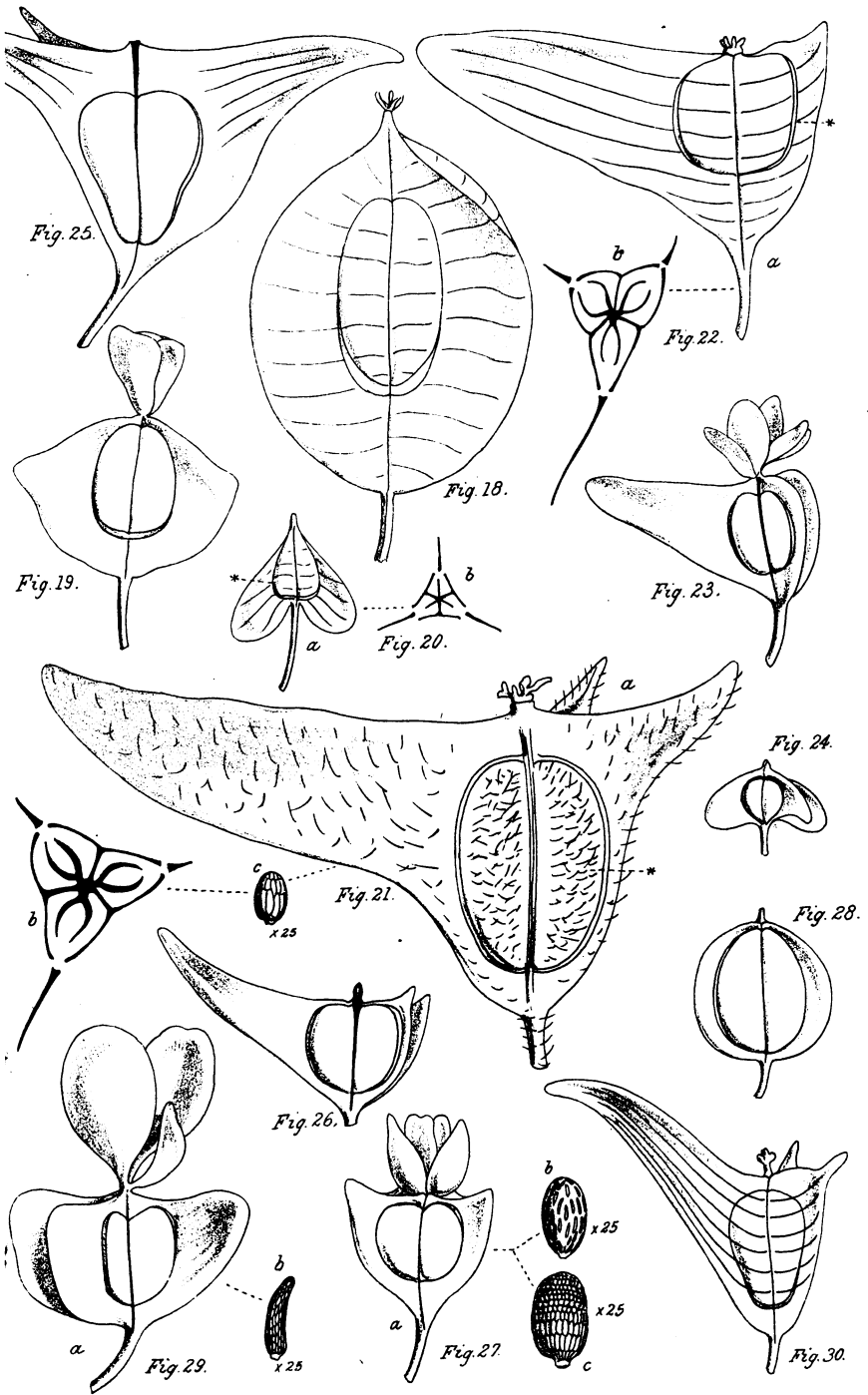

Notes on Algæ from the Amazons and its Tributaries.

By Professor G. DICKIE, M.D.

[Read May 6, 1880.]

PROFESSOR J. W. H. TRAIL, during explorations on the Amazons and branches, was very assiduous in collecting the Algæ of the regions visited. The materials thus accumulated have enabled me to compile the present summary.

Nordstedt has described some Brazilian freshwater Algæ, chiefly Desmids. A few collected by A. Glaziou were recorded by Dr. G. de Martens in 1871. In the following lists I am indebted to Mr. John Roy for notes of the Desmids; and I have also to acknowledge assistance from the Rev. G. Davidson in recording the Diatoms; some of them have also been submitted to Grunow, who is one of the highest authorities in this department.

LEMANIACEÆ.

COMPSOPOGON LEPTOCLADOS, *Mont.* Ipiranga, Rio Purus; Lago Manacapuru, Rio Solimoes; and Rio Tonantins.

BATRACHOSPERMACEÆ.

THOREA TRAILI, n. sp. Dense cæspitosa, uncialis, obscure viridis; ramis rigidis, ramulis flaccidis, articulis diametro 5-6 longioribus.

Forming dense tufts on wet sandstone rocks at Caxoeira grande, near Manaus, and de Taruma.

BATRACHOSPERMUM MONILIFORME, *Roth.*, var. PROLIFERUM, near Manaus; var. NODIFLORUM, near Obydos.

CHÆTOPHORACEÆ.

STIGEOCLONIUM PLUMOSUM, *Kuetz.* Seems but a variety of the Cayenne plant. Lake Manacapuru.

COLEOCHÆTE SCUTATA, *Breb.* A form of the European species. Upon fallen leaves in Rio Negro.

MICROTHAMNION STRICTISSIMUM, *Rabenh.* The specimens correspond well with the figure and description of the species. Mouth of the Rio Negro at Lagos.

CHROOLEPIDÆ.

CHROOLEPUS FLAVUM, *Kuetz.* On trees, east bank, Rio Madeira. Long since recorded as found in Chili and Peru.

ULOTHRICACÆ.

ULOTHRIX OSCILLARIA, *Kuetz.?* Pools in sandbank, R. Purus.

CEDOGONIACÆ.

BULBOCHÆTE PEDICELLATA, *Mont.* Apparently identical with the species described by Montagne from French Guiana. On decaying plants, Lago Paxusara, near Montealegre.

CEDOGONIUM CAPILLACEUM, *Kuetz.* Near Manaos; in Rio Jurua and near Para.

C. CAPILLARE, *Kuetz.*, var. *PANNOSUM*. Forming dense strata on wet sandstone rocks at Manaos.

C. DELICATULUM, *Kuetz.?* Near Para.

C. FASCIATUM, *Kuetz.* Pools on the beach, Rio Purus.

C. SCUTATUM, *Kuetz.* Rio Trombetas.

CONFERVACÆ.

CLADOPHORA MOLLIS, *Ag.* Near Manaos; and Barreiras de Capana, Rio Purus.

RHIZOCLONIUM ANTILLARUM, *Kuetz.* Near Obydos.

R. SPONGIOSUM, n. sp. Pallide viride, dense intricatum, in cœspites spongiosos expansum, articulis duplo v. quadruplo diametro longioribus.

Forming spongy masses $\frac{1}{4}$ to $\frac{1}{2}$ inch thick on wet sandstone rocks near Manaos.

CONFERVA ANTILLARUM, *Kuetz.* Caxoeira grande, near Manaos; and at Santarem.

GLÆOTILA NIGRESCENS, n. sp. Mucosa, nigro-viridis, articulis diametro (·0004 unc.) plerumque æqualibus. In Rio Trombetas.

G. AUREA, n. sp. Membranacea, aurea, articulis æqualibus, quadratis, diametro ·0003 unc. Rio Madeira.

VAUCHERIALEÆ.

VAUCHERIA — ? Belongs to the genus, but too imperfect for specific determination. On moist earth, Porto Salvo, Rio Purus.

ZYGNEACEÆ.

SPIROGYRA TROPICA, *Kuetz.* Of very general distribution in the region.

S. DUBIA, *Kuetz.*, var. LONGIARTICULATA. Hyutanaham, Rio Purus; and Rio Tapajos.

S. LONGATA, *Kuetz.*? Igarape de Remedio, near Manaos.

MOUGEOTIA — ? Too imperfect; along with the last.

ZYGOGONIUM ERICETORUM, *Kuetz.* Beach at Manaos.

Z. PERUVIANUM, *Kuetz.*? Hard clay rock in a stream at Hyutanaham, Rio Purus.

ZYGNEMA SUBTILE, *Kuetz.* Beach at Tefte.

PROTOCOCCACEÆ.

PROTOCOCCUS VIRIDIS, *Ag.* Damp wood at Tabatinga, and at Serpa.

LIMNODICTYON OBSCURUM, n. sp. Thallo mucoso-gelatinoso, luteo-ærugineo; trichomatibus leniter flexuosis, æqualibus, articulis globosis, subarcte connexis, diametro .001 unc.

Along with *Spongilla paulula* of Bowerbank, on leaves of *Caladium arborescens*, marshy stream at Obydos.

PALMELLACEÆ.

RAPHIDIUM POLYMORPHUM, *Fres.* A form of the European species. A green layer on leaves in stagnant water, Carvoeiro, Rio Negro.

SCYTONEMACEÆ.

SCYTONEMA ÆRUGINEO-CINEREUM, *Kuetz.* Dripping clay cliff and on wet stones, Rio Purus.

NOSTOCHACEÆ.

NOSTOC LÆVIGATUM, *Kuetz.* Dripping cliff, Barreiras de Maniwa, Rio Purus, and similar places beside the Amazons.

SPHÆROZYGA OSCILLARIOIDES, *Kuetz.* Barreiras de Hyutanaham, Rio Purus; also at Prainha.

ANABENA GIGANTEA, *Woods.* Pools near Obydos.

A. SCABRA, n. sp. Libere natans, cærulea; trichomatibus curvatis, articulis sphæricis, scabris, diam. .0004. Rio Tapajos at Santarem.

Prof. Trail notes that "the water requires to be strained before drinking, being very full of Algæ of a light blue-green colour; patches several yards in extent are constantly floating in the stream."

A. CHILENSIS, *Mont.* At Sao Paulo, Rio Solimoes.

A. BULLOSA, *Kuetz.* Moist places in the forest at Porto Salvo, Rio Purus; and swamps at Sao Paulo.

CYLINDROSPERMUM RIPARIUM, *Kuetz.?* Probably identical with the species widely diffused in Europe. Various places, Rio Purus, Rio Madeira, Rio Sapo, at the mouth of Rio Jutahi.

C. CÆRULEUM, n. sp. Trichomatibus subrectis, cæruleis, æqualibus, intricatis, articulis ellipticis (diam. .0002 unc.), ad genicula plus minus constrictis, homogeneis; sporis ellipticis, maturitate fuscis, diam. .0008 unc.

Surface of moist sandy clay at Barreiras de Hyutanaham, and moist places in the forest at Porto Salvo, Rio Purus.

C. JANTHINUM, n. sp. Trichomatibus plus minus curvatis, moniliformibus, in stratum janthinum intricatis, articulis sphæricis, diam. .0002. Sporis? Along with the last.

OSCILLARIACEÆ.

INACTIS OBSCURA, n. sp. Phycomatibus numerosis, minutis, in crustam continuam ferrugineam aggregatis, fibris diam. .0002.

On moist soft sandstone at Caxoeira grande, Manaos, and at Caxoeira de Taruma.

I. FASCICULATA, *Grunow?* Continuous crusts on dripping sandstone rock at Caxoeira de Taruma.

HYDROCOLEUM THERMALE, *Kuetz.?* In clear stream at Igarape de Manaos.

CHTHONOBLASTUS OLIGOTHRIX, *Kuetz.* In clear water at Tabatinga.

LYNGBYA RUFESCENS, *Crouan?* On stones from margin of Rio Purus.

L. GUAYANENSIS, *Kuetz.* Paricatuba, Rio Purus; and Barreiras de Jutahi, Rio Solimoes.

L. PUTEALIS, *Mont.* Near Montealegre.

L. ARACHNOIDEA, *Kuetz.?* Porto Salvo, Rio Purus.

PHORMIDIUM PARALLELUM, *Kuetz.* Jaguarary, Rio Tapajos.

P. AUSTRALE, *Ag.* On wet soil at Retenceao, Rio Purus.

P. SPADICEUM, *Carm.* On the wood of the Crozier Canoe.

OSCILLARIA TENUIS, *Ag.*, var. *CALIDA*. Near Obydos and Manaus.

O. PRINCEPS, *Vaucher.* Pools in the forest at Parauary, Rio Solimoes.

O. ANTILLARUM, *Kuetz.* Damp rotting trees at Pupunha, Rio Jurua; near Obydos.

O. AMERICANA, *Kuetz.* Near Obydos.

HYPHEOTHRIX CYANEA, *Kuetz.?* Web-like stratum on damp places, Tonantins; and Pupunha, Rio Jurua.

H. LUTESCENS, *Rabenh.* Moist cliffs, Thomar, Rio Negro; at Sobral, Rio Purus; and Lago Arapecu, Rio Trombetas.

H. LATERITIA, *Kuetz.*, var. *KERMESINA*. Moist places at Para.

H. OLIVACEA, *Kuetz.* An olive crust on wet rocks, Rio Tapajos.

H. THERMALIS, *Rabenh.* Moist soil and rocks, Hyutanaham and Paricatuba, Rio Purus.

H. LAMINOSA, *Rabenh.?* Moist places in the forest at Porto Salvo, Rio Purus.

H. VULPINA, *Kuetz.* Dripping cliffs by the Amazons.

H. TENUISSIMA, *Rabenh.* Moist surfaces, Uara, Rio Solimoes.

BEGGIATO A ALBA, *Vaucher.* South bank, Rio Negro.

B. ARACHNOIDEA, *Rabenh.?* Moist spots near Rio Mauhes.

CHROOCOCCACEÆ.

MICROCYSTIS OLIVACEA, *Kuetz.* Moist places near Obydos; near Esaltacion, Rio Madeira; and Porto Salvo, Rio Purus.

M. CÆRULEA, n. sp. Thallo membranaceo, cæruleo; familiis globosis, diam. .006; cellulis sphæricis, diam. .00002-00005.

In Rio Tapajos, in small bays after heavy rain.

M. LOBATA, n. sp. Thallo plus minus irregulariter lobato; cellulis sphæricis, diam. .0002; cytoplasmate colore læte virente.

Forming a green layer on the surface of the water of Rio Tapajos.

APHANOCAPSA MEMBRANACEA, *Rabenh.?* Appears to be identical with the European plant found at Mentone. In a deposit of mud from the Mauhes river, 6° 30' S. lat.

DESMIDIÆ.

My friend Mr. John Roy, one of our local microscopists, made this list of species detected by him in various materials from the Amazons region. He stated that there are at least as many new, which remain for future description. In the following list "Purus" refers to pools in a sandbank on the margin of the river Purus, in 65° 22' W. long. and 7° 35' S. lat. "Montealegre" refers to Lago Paxusara near Montealegre.

SPONDYLIIUM PULCHELLUM, *Archer.* Montealegre.

GONATOZYGON RALFSII, *De Bary.* Montealegre.

MICRASTERIAS FURCATA, *Ralfs.* This differs slightly from the British form, but agrees with that recorded by Nordstedt. Near Montealegre.

M. CRUX-MELITENSIS, *Ehrenb.* Montealegre.

M. LATICEPS, *Nord.* Montealegre.

M. DIDYMACANTHA, *Naeg.* Montealegre.

EUASTRUM CUNEATUM, *Jenner.* Purus.

E. SINUOSUM, *Lenorm.* Montealegre.

E. QUADRATUM, *Nord.* Near Para.

COSMARIUM ORNATUM, *Ralfs.* Montealegre.

C. BOTRYTIS, *Bory.* Montealegre.

- COSMARIUM PULCHERRIMUM, *Nord.* Purus.
 C. PSEUDO-CONNATUM, *Nord.* Montealegre.
 C. GLOBOSUM, *Bulrh.* Montealegre.
 C. GRANATUM, *Breb.* Purus.
 C. VENUSTUM, *Breb.* Purus.
 XANTHIDIUM REGULARE, *Nord.* Montealegre.
 ARTHRODESMUS BIFIDUS, *Breb.* Montealegre.
 STAUASTRUM ARISTIFERUM, *Ralfs.*
 S. GRACILE, *Ralfs.*
 S. QUADRANGULARE, *Ralfs.* var. β . ATTENUATUM, *Nord.* Montealegre.
 S. INEQUALE, *Nord.* Montealegre.
 CLOSTERIUM PRITCHARDIANUM, *Archer.* Purus.
 C. PARVULUM, *Naeg.* Montealegre.
 C. INCURVUM, *Breb.* Montealegre.
 DOCIDIUM MINUTUM, *Ralfs.* Montealegre.
 TETMEMORUS GRANULATUS, *Breb.* Montealegre.
 PENIUM DIGITUS, *Ehrenb.* Montealegre.
 P. OBLONGUM, *De Bary.* Montealegre.
 P. NAVICULA, *Breb.* Montealegre.
 P. MARGARITCEUM, *Ehrenb.* Montealegre.

DIATOMACEÆ.

In compiling the following list I have received important assistance from the Rev. G. Davidson, of Logie Coldstone.

There is such difference of opinion regarding species of *Eunotia*, that I prefer giving in one tabular list the forms observed in various materials collected by Professor Trail.

<i>Eunotia monodon</i> , <i>Ehrenb.</i>	<i>Eunotia septena</i> , <i>Ehreb.</i>
<i>E. diodon</i> , <i>Ehrenb.</i>	<i>E. enneodon</i> , <i>Ehrenb.</i>
<i>E. triodon</i> , <i>Ehrenb.</i>	<i>E. hendecaodon</i> , <i>Ehrenb.</i>
<i>E. tetraodon</i> , <i>Ehrenb.</i>	<i>E. zygodon</i> , <i>Ehrenb.</i>
<i>E. quaternaria</i> , <i>Ehrenb.</i>	<i>E. declivis</i> , <i>Ehrenb.</i>
<i>E. quinaria</i> , <i>Ehrenb.</i>	<i>E. nodosa</i> , <i>Ehrenb.</i>
<i>E. heptodon</i> , <i>Ehrenb.</i>	<i>E. sella</i> , <i>Ehrenb.</i>

Eunotia Camelus, *Greg.*
E. formica, *Grunow.*
 Mud from stomach of "Acari," a species of *Loricaria*, a mailed fish of the region*.
Melosira californica, *Ehrenb.?*
Nitzschia constricta, *Pritch.*
Surirella linearis, *W. Sm.*
S. tenera, *Greg.*, var.
S. biseriata, *Breb.*
S. oophæna, *Ehrenb.?*
Gomphonema coronatum, *Kuetz.*
Synedra pulchella, *Kuetz.*
Navicula undosa, *Ehrenb.*
N. viridis, *Kuetz.*
N. appendiculata, *Kuetz.*
 In a stream at Lagos, mouth of the Rio Negro.
Cocconeis placentula, *Ehrenb.*
Synedra ulna, *Ehrenb.*
S. biceps, *Kuetz.*
Navicula amphirynchus, *Ehrenb.*
N. lanceolata, *Ehrenb.*
N. rhomboides, *Ehrenb.*
Ceratoneis excisa, *Ehrenb.*
Himantidium pectinale, *Kuetz.*
Actinella mirabilis, *Grunow*, and several forms of *Eunotia*.
 Hole in fallen tree, Paricatuba, Rio Purus.
Navicula biceps, *Ehrenb.*
N. Brauniana, *Grunow.*
N. rhomboides, *Ehrenb.*
N. mesolepta, *Ehrenb.*
N. bohémica, *Ehrenb.*
N. cuspidata, *Kuetz.*
N. gibba, *Ehrenb.*
N. dicephala, *Ehrenb.*
Gomphonema cristatum, *Ralfs.*
G. turris, var. *apiculatum*, *Grunow.*
Melosira varians, *Ag.*
M. subflexilis, *Kuetz.*

Stauroneis anceps, var. *linearis*, *Ehrenb.*
Diademesmis confervacea, *Kuetz.*
Desmogonium guianense, *Ehrenb.*
 Mud on leaves left by fall of Rio Negro.
Gomphonema vibrio, *Ehrenb.*
G. anglicum, *Ehrenb.*
Navicula rhomboides, *Ehrenb.*
N. gibba, *Ehrenb.*
N. acuta, *Kuetz.*
Ceratoneis alpina, *Grunow?*
Himantidium gracile, *Grunow?*, and forms of *Eunotia*.
 Wet sandstone rocks at Manaos.
Navicula rhomboides, *Ehrenb.*
N. macilenta, *Ehrenb.*
N. cryptocephala, *Kuetz.*
N. lata, *Breb.*
N. subcapitata, *Greg.*
N. exigua, *Greg.*
Himantidium pectinale, *Kuetz.*
Cymbella scotica, *W. Sm.*
Surirella linearis, *W. Sm.*
Nitzschia sigma, *W. Sm.*
 Jaguarary, Tapajós.
Stauroneis phœnicenteron, *Ehrenb.*
S. phyllodes, *Ehrenb.*
Navicula americana, *Ehrenb.*
N. firma, *Kuetz.*
N. oblonga, *Kuetz.*
N. rhomboides, *Ehrenb.*
N. gibba, *Ehrenb.*
N. rupestris, *O'Meara.*
N. termitina, *Ehrenb.*
N. major, *Kuetz.*
Synedra ulna, *Ehrenb.*
Gomphonema lanceolatum, *Ehrenb.*
G. dichotomum, *Kuetz.*
Cymbella pusilla, *Kuetz.*
C. obtusiuscula, *Kuetz.*

* The diatoms recorded were probably attached to vegetable &c. food.

Odontidium tabellaria, *W. Sm.*
Orthosira punctata, *W. Sm.*, and
 several forms of *Eunotia*.

Pool on beach at Tefé.

Orthosira punctata, *W. Sm.*
Synedra radians, *W. Sm.*
S. capitata, *Ehrenb.*
Navicula conops, *Ehrenb.*
N. appendiculata, *Kuetz.*
N. lævissima, *Kuetz.*
Surirella linearis, *W. Sm.*
Diatoma elongatum, *Ag. ?*

On leaves, Rio Mauhes.

Navicula rhomboides, *Ehrenb.*
Gomphonema lanceolatum,
Ehrenb.
G. dichotomum, *Kuetz.*
Himantidium majus, *W. Sm.*
Desmogonium guianense, *Ehrenb.*
Stauroneis anceps, *Ehrenb.*
Nitzschia Victorixæ, *Grunow.*

Mud of Rio Mauhes, near Caxoeira
 de Portao.

Navicula rhyncocephala, *Kuetz. ?*
N. viridis, *Ehrenb.*
N. mesolepta, *Ehrenb.*
N. pisciculus, *Ehrenb.*
N. major, *Kuetz.*
Gomphonema lagenula, *Kuetz.*

Pool in Ygapo (*i. e.* forest or
 brushwood under water for part
 of the year) at Coary.

Navicula viridis, *Ehrenb.*
N. binodis, *Ehrenb.*
N. mesolepta, *Kuetz.*
N. amphirynchus, *Ehrenb.*
N. angustata, *W. Sm.*
N. nodosa, *Ehrenb.*
N. Hilseana, *Janisch.*
N. rhomboides, *Ehrenb.*
N. Brebissonii, *Kuetz.*
Gomphonema subtile, *Ehrenb.*
G. lanceolatum, *Ehrenb.*

Orthosira punctata, *W. Sm.*
Surirella panduriformis, *W. Sm.*

Pools in sandbank, Rio Purus,
 7° 35' S., 65° 22' W.

Navicula Perrotettii, *Grunow.*
N. bicapitata, *Lagerst.*, var.
major.
N. stauroptera, *Grunow.*
N. isocephala, *Ehrenb.*
N. mesotyla, *Ehrenb.*
N. Braunii, *Grunow.*
N. amphiceros, *Grunow*, var.
parva.
N. affinis, *Ehrenb.*, var. *tropica.*
N. viridis, *Ehrenb.*, var. *commu-*
tata.
N. firma, *Kuetz.*, vars. *tropica* and
dubia.
N. Brebissonii, *Kuetz.*
N. appendiculata, *Kuetz.*
N. semilunum, *Grunow.*
N. pachyptera, *Ehrenb.*
Stauroneis birostris, *Ehrenb.*
Schizostauron crucicula, *Grunow.*
Hantzschia brasiliensis, *Grunow.*
Nitzschia palea, var. *tropica*,
Grunow.
N. (Pseudotryblionella) Davidsoni,
Grunow.
Actinella brasiliensis, *Grunow.*
Othosira punctata, *W. Sm.*
Amphora gracilis, *Ehrenb.*

Paricatuba, Rio Purus, the
 following:—

Navicula gibba, *Ehrenb.*
N. placentula, *Ehrenb.*
Gomphonema cristatum, *Ralfs.*
Ceratoneis Arcus, *Kuetz.*
Melosira varians, *Ag.*
Orthosira punctata, *W. Sm.*

Lago Manacapuru, Rio
 Solimoes.

Navicula tabellaria, *Kuetz.*

Navicula major, *Kuetz.*
N. gibba, *Ehrenb.*
Stauroneis linearis, *W. Sm.*
Synedra vitrea, *Kuetz.*
S. obtusa, *W. Sm.*
S. biceps, *W. Sm.*
Nitzschia panduriformis, *Greg.*
Stauroneis anceps, *W. Sm.*
Himantidium gracile, *Grunow.*
Ceratoneis alpina, *Grunow.*

Near Montealegre in Lago
 Paxusara.

Navicula gibba, *Ehrenb.*
N. Breissonii, *Kuetz.*
N. rhyncocephala, *Kuetz.*
N. acuta, *W. Sm.*
Synedra biceps, *Kuetz.*
Himantidium gracile, *Grunow.*

On leaves of *Polygonum*, Rio
 Trombetas.

Several forms of *Eunotia*.
Navicula rhomboidea, *Ehrenb.*
N. Bacillum, *Ehrenb.*

Navicula gracillima, *Pritchard.*
N. ovalis, *W. Sm.*
N. exigua, *Greg.*
N. dirynchus, *Ehrenb.*
N. americana, *Ehrenb.*
Desmogonium guianense, *Ehrenb.*
Actinella mirabilis, *Grunow.*
Synedra biceps, *Kuetz.*
S. ulna, *Ehrenb.*
Stauroneis anceps, *Ehrenb.*
Nitzschia thermalis, *Awd.*
Cymbella scotica, *Kuetz.*
C. turgida, *Greg.*
Gomphonema lanceolatum,
Ehrenb.
G. turris, *Ehrenb.*
G. vibrio, *Ehrenb.*
G. hebridense, *Greg.?*
Amphora delphinia, *Bailey.*
Surirella linearis, *Ehrenb.*
S. demerarae, *Ehrenb.*
S. arcta, *Schmidt.*

On *Codiolum gregarium*, A. Braun.

By EDWARD MORELL HOLMES, F.L.S.

[Read March 4, 1880.]

THIS interesting addition to the British marine flora was discovered at Teignmouth, in November 1855, by the Rev. R. Cresswell, but not identified until the close of last year, when specimens were sent to Dr. Bornet and recognized by him. Comparatively few algologists in this country have paid attention to the minute algæ which grow near high-water mark, to which Mr. Cresswell has almost exclusively directed his investigations. For this reason he has not only met with many species overlooked by other algologists, but has been the fortunate discoverer of the curious *Schizothrix Cresswellii*, and of the somewhat anomalous plant which forms the subject of the present communication, and which has now, for the first time, been recorded as a British alga.

Codiolum gregarium was first discovered in 1852 by A. Braun in Heligoland, growing on posts and woodwork near the sea, and

has been found since that date in the United States by Dr. Farlow. It is either rare or has often been overlooked. As seen in the spot in which Mr. Cresswell pointed it out to me, it forms a scattered velvety growth of a dark-green colour on the vertical surface of the sandstone blocks of the sea-wall, where it is liable to be wetted by the spray at high tide only, unless the sea be rough, in which case the surf dashes over it. According to Mr. Cresswell's observations, it grows also on the blocks of Devonian limestone which form a portion of the same wall. He has found it throughout the winter, year after year, in the same place, presenting the same appearance to the naked eye, and the same characters under the microscope. In June he has found full-grown specimens in a spot where the plant is within reach of every tide.

Braun has given a full account of the development and mode of fructification of *Codiolum gregarium* in the 'Abhandlungen' of the Berlin Academy; and to his valuable paper I am largely indebted for the details here given.

The full-grown plant consists of a simple stalked cell of a cylindrical form, clavate at the upper end, and containing obovate zoogonidia. The whole plant is only 1-1½ millim. long, the club, or upper portion containing the zoogonidia, being usually ⅓ millim. long and $\frac{1}{18}$ - $\frac{1}{18}$ millim. thick, and the hyaline stalk 1½ to 3 times as long as the club, and $\frac{1}{20}$ - $\frac{1}{18}$ millim. thick, gradually tapering towards the rounded base.

The youngest specimens present the form of an obovate cell, the first stage in the growth of which is the appearance of a hyaline elongation of the narrow end, which gradually increases until the plant becomes of the adult stature, the clavate portion increasing in diameter very slightly until the stalk has attained its full development, *i. e.* two or three times the length of the club. Under the action of chemical reagents the cell-wall (cytioderm) is seen to be composed of three layers. The outer, or exoderm, covers the whole plant, and is a thin uniform membrane. The inner, or endoderm, is similar in character, but is found only as the sac which contains the zoogonidia, the whole of the interior of the stalk being filled with the middle layer, which consists of a firm gelatine; but between the inner and outer layers of the club it forms a thin stratum only. In the young state the cavity of the club is filled with green endochrome (cytioplasm), in which

amylaceous globules appear. When the cell (now called a gonocytium) takes on the function of reproduction, these globules first aggregate into little groups, and eventually disappear, while the endochrome becomes of a more intense green colour and granulated appearance. The intermediate stages between this granulation and the formation of the obovate zoogonidia do not appear to have been observed. Like those of *Codium tomentosum*, which they resemble in shape, the zoogonidia have their narrow end pointing outwards; they are, however, smaller than in that plant, being only $\frac{1}{8}$ millim. long. When mature, the zoogonidia escape from an opening in the apex of the club; each is furnished with two vibratory cilia at the narrow end.

Besides this form of reproduction there are found mixed among the tufts perfectly globose cells, larger than the zoogonidia, with the contents (cytoplasm) more evidently granular, and the cell-wall (cytioderm) triple, as described above, with the middle layer gelatinous. Braun believes these to play the rôle of resting-spores, and to preserve the plant during the winter and spring months, as it does not grow again until the end of summer. To these cells he has given the name of hypnospores. The plant, in this country at least, lasts through the winter and spring, and has been found as late as the month of June, according to Mr. Cresswell's observations, while I have myself gathered it at Christmas. For the above and the following reasons, it appears to me doubtful if the so-called hypnospores belong to *Codiolum* at all. The tufts of *Codiolum gregarium* always contained plants in every stage of growth. They frequently have several species growing intermixed, especially *Hormotrichum flaccum* and *Calothrix scopulorum*. I have met with spherical cells answering to Braun's description among *Codiolum*, and also other cells presenting a similar shape, showing a single division of the endochrome, and evidently resembling in diameter and appearance the very young filaments of *Hormotrichum flaccum* with two, four, or eight divisions, which occur in the same tuft. It seems to me highly probable therefore that the so-called hypnospores of *Codiolum* are only the earliest stage of growth of *H. flaccum*.

Codiolum occupies a somewhat anomalous position. In vegetation it agrees with the stalked Protococcaceæ, while the fructification corresponds exactly in character with that of *Codium* (see Ann. des Sc. Nat. sér. 3, tom. xiv. p. 23). *Codiolum*, however, grows chiefly at the base, and the vegetative cell performs the functions of

reproduction, while *Codium* grows at the apices and produces lateral branches and fruit-cells distinct from the vegetative part. The name *Codiolum*, therefore, is a most appropriate one.

THE ANNIVERSARY ADDRESS OF THE PRESIDENT,
Professor ALLMAN, M.D., LL.D., F.R.S.

Aspects of Vegetation in the Littoral districts of Provence, the Maritime Alps, and the western extremity of the Ligurian Riviera : a Chapter in the Physiognomy and Distribution of Plants.

[Read May 24, 1880.]

SOME recent visits made during the spring months to Provence and the Ligurian coast afforded an opportunity of studying the vegetation of these parts of the Mediterranean shores; and it has occurred to me that some of the notes then made might form an appropriate subject for one of the annual addresses which it is customary to deliver from this chair.

Separated by the western Alps from Central and Northern Europe, and traversed by the subordinate chains and outlying groups of hills which, belonging to the system of the Maritime Alps, give to its surface the charm of a configuration singularly varied by elevated hills, deep valleys, and low-spreading plains, there lies in the south of France a belt of country which, embracing a great part of Provence, has its western limits near Marseilles, and thence stretching along the shores of the Mediterranean includes the districts of Hyères, Cannes, Nice, and Mentone, and becomes continuous in the east with the Ligurian shores of Italy.

Nowhere in Europe is there a region which in winter and spring basks under the rays of a more genial sun, where its mountain barriers more thoroughly defend it from the icy winds which sweep over the unprotected plains of the north; and when the season of rains is at an end, there spreads over all this sunny land an atmosphere of absolute transparency; while away upon its extreme southern boundary lie the waters of the Mediterranean, flowing round wooded crags and picturesque headlands, and gleaming with an intensity of blue approached by that only of the cloudless sky which stretches over all.

The narrow littoral region thus physically characterized gives origin to a rich and remarkable flora, whose eminently southern

features are scarcely again met with before arriving at the latitude of Naples, about four degrees further south; for throughout Lombardy, Tuscany, and the districts formerly included in the Pontifical States, the plants mainly belong to the forms of Central Europe. It is to some of the characters of the flora of Provence and Liguria that I now wish to call your attention.

It is no part of my purpose to occupy you with the details of Mediterranean botany. However limited may be the district under review, such details would be unsuited to an occasion like the present, even did the time at our disposal allow of our entering into them. I shall therefore confine myself to those general aspects of the flora which exert an influence on the natural scenery—to that special physiognomy of the vegetation by which the traveller from the north becomes instantly impressed with the conviction that he has entered on a distinct and unfamiliar phase of organic nature.

When we seek for the conditions which give to the flora of the western Riviera a character so essentially its own, we find a climate remarkable for the mildness of its winters and the high temperature and dryness of its summers. It is thus neither a purely insular nor a purely continental climate; for the cool summers of the former and the rigorous winters of the latter are here equally absent.

No less peculiar is the distribution of rain throughout the year. The season of rains is confined to the winter and spring months, while the summer is, as a rule, absolutely rainless.

With the most important elements of climate thus distributed, a well-marked influence must be exerted in determining the periods of active vegetation. After the winter rains have supplied the humidity essential to the perfect development of vegetation, there bursts upon the whole country with the coming spring a richness of foliage and of blossom as beautiful in its forms and in its colours as it is marvellous in its suddenness. And then when spring is succeeded by the hot rainless summer, vegetation becomes arrested, and the freshness of the spring landscape is gone; for even the evergreens become dull and lustreless under the increasing heat and aridity of summer.

If there be one feature more than another which characterizes the vegetation of the Mediterranean shores it is the abundance of evergreen trees, belonging to forms different from that of the acicular-leaved Coniferæ; and in no part of these shores is the

evergreen vegetation more highly developed, in none does it hold a more important place in the landscape than in the region now before us.

It is not, however, only the evergreens strictly indigenous to the country which by their effect in the landscape convey an impression of something essentially different from the vegetation of the north. Many have from very remote periods become objects of cultivation; and the olive, the orange, and the lemon are scarcely less important in their influence on the scenery than the trees which spring spontaneously from the soil.

The weight of evidence is in favour of the conclusion that the native country of the olive is in the south-eastern parts of the Mediterranean area, from which it was carried westward into the districts where it is now cultivated. It is true that there occurs here a wild form of the olive; but it is probable that this has only escaped from cultivation. Certain it is that the orange and the lemon are of oriental origin, and owe their present existence in Provence, Spain, and other western stations to the agency of man.

In the region now under review, the olive forms in the landscape one of its most striking and characteristic elements; and whether clothing the hill-side or stretching along a line of coast with glimpses here and there of the deep blue of the Mediterranean caught through its greyish-green foliage, it gives rise to a combination of picturesque effects from which the scenery of the Riviera derives one of its greatest charms. The form of the olive is much modified by cultivation, and the usual rounded contour of the trees is in great measure the result of the lopping to which they are subjected with the view of rendering the fruit more abundant. Where, however, this excessive pruning is not adopted, and the tree left more to its natural growth, it attains a much more considerable height; and the pendulous branches, with their rich masses of foliage, give to it then an aspect singularly graceful and striking.

With the sombre vegetation of the olive, the bright green lustrous foliage of the orange and the lemon forms a well-marked contrast. The lemon has a more limited range than the orange, and it is only in the hottest and most sheltered spots of the coast that it can be cultivated with advantage; while the area even of the orange is an exceedingly narrow one in comparison with that of the olive. In their altitudinal range the orange and the lemon

are limited to the plain and to the lowest region in the hills, while the cultivation of the olive attains in this part of the Riviera an altitude of 2400 feet.

The vine is also extensively cultivated in the plains, and in the hills ascends above the limit of the olive. During March and April, however, it is destitute of leaves, and forms as yet no feature of importance in the vegetation.

But the olive and the *Aurantiaceæ* constitute only single elements among the evergreen trees. At Hyères the Cork-oak (*Quercus Suber*) and the Evergreen Oak (*Quercus Ilex*) cover the lower hills with an indigenous growth, and contribute, with the Bay (*Laurus nobilis*) and the Arbutus (*Arbutus Unedo*), in forming the beautiful evergreen woods which clothe the rocky soil; while the Carrub (*Ceratonia Siliqua*) chiefly occurs along a narrow littoral zone between Nice and Mentone, where, with its large glossy, deep green, pinnate leaves and tropical aspect, it constitutes one of the most beautiful features in the coast-line.

Besides these evergreen trees with comparatively broad leaves, the narrow acicular-leaved Conifers play an important part in the physiognomy of the vegetation.

The Stone-Pine (*Pinus Pinea*), though here and there met with, is much less frequent and characteristic than in Central and Southern Italy, where, with its dark green spreading umbrella-like crown, it is inseparably associated with our conception of the Italian landscape.

Far more abundant is the Pinaster (*Pinus Pinaster*). The form of this pine met with in the hills of Provence is much finer than that of the variety usually grown in England. When it has room to develop itself, and escapes the almost universal practice of having all the branches within reach lopped away for firewood, it forms a large and handsome tree, with its crown more or less pyramidal and with its stem well furnished with branches nearly to the ground. It affords a well-marked and pleasing contrast with the more rounded crown, paler and less rigid leaves, and greyer bark of the Aleppo Pine (*Pinus halepensis*), with which it is here usually associated. This last is eminently the pine of the Provence hills; it never grows to the height of the Pinaster, and, indeed, in some places retains almost a frutescent habit. Covering by itself alone, to the exclusion of other trees, wide tracts of country, or else accompanied by the Pinaster, the Cork-oak, the

Ilex, the Arbutus or the Bay, it is the form of arborescent vegetation which contributes most to the wooding of the hills and to the character of the landscape.

Among the coniferous trees which form a prominent feature in the landscape of Provence, the Italian Cypress (*Cupressus sempervirens*) must be especially mentioned. Its very distinct porte, springing, as it does, from the ground in a lofty tapering spire of intensely dark green foliage, places it in striking contrast with every other tree form. It is usually planted on the plain in picturesque groups, by which the eye is led to the far-off wooded hills by a succession of distances which no other object in the landscape could so efficiently supply. Occasionally it is planted singly among the olive-woods on the hill-side; and then the tall spires of the cypress, with the green of the foliage almost black in its intensity, offer a contrast with the low, rolling, greyish-green masses of the olive-wood above which they tower, greater than perhaps can be found between any other two forms of exogenous arborescent vegetation.

With the evergreen trees of the hills are associated some whose leaves fall on the approach of winter. Among these one of the most frequent and striking is a variety of our northern Oak (*Quercus Robur*), whose young leaves clothed with a reddish-brown pubescence form a well-marked contrast with the darker tints of the surrounding evergreens, and become an additional element of beauty in the woods. In other trees, again, of deciduous habit it is the flowers rather than the foliage which exert the chief influence on the landscape; and in early spring the Judas tree (*Cercis Siliquastrum*), introduced from Western Asia, covers its leafless branches with masses of rosy-purple flowers; while the cultivated lands are made bright by the delicate pink of the Almond-blossom, and a little later the Peach-tree flushes the country with its deeper rose.

But besides the proper arborescent vegetation there are hosts of evergreen shrubs which, no less than the true trees, enter into the composition of the landscape. Even where the hills are well wooded, the ground beneath the trees gives origin to an abundant underwood. In many places, especially about Hyères, this is mainly composed of the prickly evergreen bushes of the Kermes Oak (*Quercus coccifera*), which, though assuming in more eastern countries an arborescent habit, remains in this part of the Riviera in the condition of a shrub some three or four feet in height.

In other places the underwood is largely composed of the rigid shrubs of the wild olive, associated with the deeper green and more glossy-leaved Phillyreas (*Phillyrea angustifolia* and *P. latifolia*), the Lentiscus (*Pistacia Lentiscus*), the *Rhamnus Alaternus*, the *Juniperus Oxycedrus* (which replaces the *J. communis* of our own woods), the great Heath of the Mediterranean (*Erica arborea*), and the Myrtle (*Myrtus communis*), the only European representative of its order, while multitudes of leguminous shrubs (*Spartium*, *Genista*, *Cytisus*, and *Coronilla*) mingle their golden flowers with the greenery of the rest of the underwood. Indeed one of the most remarkable features of the woods is the luxuriance of the undergrowth. Seldom is a spot of ground left uncovered, for even the thickest woods exert no injurious action on the plants which thus grow so freely beneath their shadow.

Rich, however, as is the undergrowth of the wooded hills, it is where the trees are absent, or so thinly scattered as to allow unimpeded access to the rays of the sun, that the shrubby and subfruticose vegetation becomes developed with all that multiplicity of form and freedom of growth which throws so indescribable a charm over the rugged hill-side, clothing rock and crag, and ridge, and arid cliff, and wild ravine with a plant-life such as a southern sun can alone call into existence. For here we may wander amid groves of heath, no longer limited to the humble forms of our northern moors, but attaining the height of some of the largest of our shrubs, and covered in the early spring with masses of white or pale rose-coloured flowers, which fill the air with the fragrance of a meadow of freshly-mown hay; aromatic Labiatae, Thyme (*Thymus vulgaris*) and Rosemary (*Rosmarinus officinalis*), take possession of the driest and hottest spots, while the broad leafy translucent bracts which crown the spikes of the angular-headed Lavender (*Lavandula Stoechas*) become lighted up with the intensest of violets under the obliquely-falling rays of the late afternoon sun. The spiny Smilax (*Smilax aspera*), with its heart-shaped rigid leaves and its clusters of scarlet berries, scrambles wildly over the rough stony ground; the yellow Jasmine (*Jasminum fruticans*), the elegant shrubby Globularia (*Globularia Alypum*), covered with its spherical clusters of bright blue flowers, and the *Daphne Gnidium*, with its fresh green foliage, root themselves in the crevices of the rocks; the singular little woody Euphorbia (*Euphorbia spinosa*), whose dry ligneous stems of the preceding year are concealed among the young pale green leaves of the present, adorns the

most exposed rocks with its dense hemispherical tufts; while the Spiny Broom (*Calycotoma spinosa*) covers the driest and most sterile tracts, where it replaces the furze of the north, and makes gay the stony slopes of the hills with its bright yellow blossoms.

Among the negative features of special interest presented by the flora of this part of the Mediterranean area is the absence of our northern Furze (*Ulex europæus*). This plant shows itself for the first time much further west; and it is not until we approach the Pyrenees that it becomes abundant.

To the north-west of Hyères the beautiful Syrian shrub *Styrax officinale* has made for itself a home; and with its white flowers, recalling those of the orange, but hanging in drooping clusters from the branches, adorns in May the ravines and stream-banks of Mount Coudon.

In the more eastern parts the Oleander (*Nerium Oleander*) may be found occupying the narrow valleys which confine the streams of water in their course from the hills above, while the *Euphorbia dendroides* takes possession of the rocky cliffs between Nice and Ventimiglia. It is a truly ligneous species this great Euphorbia; the stem attains at its base a diameter of two or three inches, and then with a regular trichotomous ramification rises to the height of a man. It is the nearest European representative of the gigantic Euphorbias of the Canary Islands and Western Africa. Within the limits just mentioned it is very abundant, and constitutes the most characteristic vegetation of the sea-cliffs; it is conspicuous no less by the fresh tender green of its foliage than by the singularity and beauty of its form.

Widely distributed over the whole region are numerous species of *Helianthemum*. Small Cistus-like shrubby or occasionally herbaceous plants, of more or less prostrate growth, lovers of intensest sunlight, they spread themselves over the hottest and most stony ground, making it bright with their soft yellow flowers.

But of all the plants which combine to throw over the rocky hills of the Riviera that richness of vegetable life which so eminently belongs to them, there is perhaps not one by which we are so forcibly impressed as by the true Cistuses (*Cistus albidus*, *C. salvifolius*, and *C. monspeliensis*). There is no spot too dry or shadeless for these beautiful shrubs. Their season of flowering is in the later spring and early summer, when they display day after day in unlimited profusion their large, rose-like, white, or purple flowers, and mingle the basamic odour of their leaves with

the aromatic exhalations of the Labiatae. But the life of the *Cistus*-blossom is a short one. In a few hours the corolla has fulfilled its function. Opening to the morning and to the noon, the petals soon fall to the ground, and long before the setting of the sun there is nowhere to be seen over all that hill-side a vestige of the great blossoms of white and purple which had but an hour before spread such a glory over the landscape. And day after day does the young corolla open its petals to the morning, and cast them to the ground before the evening in uninterrupted sequence until the advancing summer brings the period of flowering to an end.

But it is not alone the trees and shrubs of the Mediterranean which give character to its vegetation; multitudes of herbaceous plants burst into flower with the coming spring, and contribute to the landscape an element scarcely less important than that presented by the plants of arborescent and shrubby growth.

Where the soil has some depth, no matter how dry and sandy it may be, on the low lands near the sea-shore, or in open glades in the wooded hills, more especially in the district of Hyères, the small-fruited and large-fruited *Asphodels* (*Asphodelus microcarpus* and *A. cerasiferus*) send up to a height of more than three feet, from the midst of long pointed leaves, their great flower-stalks, dividing into many branches in the one, but a stately undivided column in the other, and in both covered with large white star-like flowers; while in the same district the sunny borders of the woods are ornamented by the nearly allied but far more delicate *Simethis bicolor*, with its flowers of a pure white within and rose-colour without; multitudes of tender *Euphorbias*, with leaves of the softest green, spring up over the rough stony soil; the long trailing stems of the *Periwinkle* (*Vinca media*) cover themselves, as they creep over the ground, with bright blue flowers, and may be seen on shady banks and in the hedges and along the margins of the watercourses; while on drier and less shady banks, and along the sunny borders of the olive-woods, the beautiful *Convolvulus altheoides* throws out its slender leafy stems, ready to twine round the first support they may meet, and laden with their large campanulate flowers of delicate rose, which expand to the hottest rays of the southern sun.

The fine cruciferous plant, *Moricandia arvensis*, affords a remarkable example of limited distribution, being on the northern shores of the Mediterranean nearly confined to a narrow area between Mortola and Ventimiglia, where it occurs abundantly and

ornaments the dry cliffs with its handsome purple flowers. Narcissuses, yellow and white, are in profusion in the plains; and with the very first breath of spring Anemones (*Anemone coronaria* and *A. hortensis*, with their many varieties) abound in the olive-woods, and fill the lower meadows and shady valleys with the marvellous beauty of their scarlet, or blue, or violet-coloured flowers; while a little later we find, associating themselves with the Anemones, brilliantly coloured Tulips—the large-flowered crimson *Tulipa præcox*, and the beautiful little *T. Clusiana*, with its elegantly pyramidal flower-buds, and its flowers of purest white banded with crimson on the outer side, and deep within the cup dashed with softest violet. Wild Flaxes of many species (*Linum narbonensis*, *L. maritimum*, and *L. viscosum*, &c.) abound in the hills, where they make the valleys bright with their blue, or pale yellow, or rose-coloured flowers. Orchids referable to many genera (*Orchis*, *Ophrys*, *Serapias*, *Epipactis*, *Spiranthes*, &c.) and of strange mimetic forms are in multitudes; there are few habitats in which some species may not be found. White and rose-coloured Alliums (*A. neapolitanum*, *A. roseum*, &c.) are in blossom in the cultivated lands, and Gladioluses (*Gladiolus segetum*) send up their tall spikes of purple flowers under the shadow of the olive-woods. In dry and stony places the beautiful little primulaceous plant, *Coris monspeliensis*, spreads over the rocks its tufts of rosy flowers; and shady banks among the hills are covered with blue Hepaticas.

Along the margins of the watercourses the leafy stems of the great Reed (*Arundo Donax*) grow to a height of twelve feet or more in picturesque groups of tropical aspect; while everywhere around their base, and vigorously pushing themselves through the soil, are the strong light green conical shoots which are to become the young stems of the new year.

Abundant on dry banks throughout the whole littoral region is the curious liliaceous plant, *Aphyllanthus monspeliensis*: you would take it for a tuft of rushes, were it not that every stem is crowned with one or two blue lily-like flowers. It is destitute of true leaves, which are represented only by brown membranous sheaths which surround the stems just above the root.

Close upon the sea-shore the *Mathiola incana* has taken possession of the most inaccessible spots upon the cliffs, which it lights up with its bright violet flowers; the handsome yellow-flowered leguminous shrub, *Coronilla valentina*, roots itself in the clefts of the rocks, where it is associated with the singular *Cneorum*

ricocum, a European representative of the tropical family of the *Simarubæ*; while the white-leaved *Cineraria maritima*, and the beautiful *Lavatera maritima*, with its large flowers of pale rose, form other striking elements in the flora of the sea-cliffs. Lower down, over the dry sandy beach the Squirted Cucumber (*Ecballium Elaterium*) sends out its prostrate stems and covers the ground with its fine dark green foliage; while here and there the curious Thymelaceous plant, *Passerina hirsuta*, presents us with a form of vegetation unknown in the flora of the north.

Such are some of the most important features in the physiognomy of vegetation in the littoral districts of Provence and in Western Liguria, as seen during the months of March, April, and May. Certain plants not strictly indigenous to this part of the Mediterranean shores, but which have become acclimatized, and by their cultivation enter largely into the industry of the country, have been already noticed; but our picture of the vegetation would be still imperfect without reference to some others which have been introduced from more southern countries, and which here, finding themselves in a congenial climate, have become important elements in the landscape.

Foremost among these is the Date-Palm (*Phoenix dactylifera*), which flourishes with but little care in most parts of the district which we have been making the subject of our study. The form of the palm is so intimately associated with the warmer regions of the globe, and its tall, straight, unbranched stem and plume-like crown of great pinnate or palmate leaves are in such strong contrast with every tree form of the temperate and colder regions, that the traveller from the north, when he witnesses for the first time the date-trees of Hyères and the Riviera, becomes more forcibly impressed by this beautiful form of vegetation, than by any other feature of the country, with the fact that he has changed his latitude.

It is remarkable, and not easily explained among the phenomena of distribution, that while the southern Date-Palm grows here so freely, and even ascends to some height upon the hills above the coast-line, the *Chamærops humilis* (the truly indigenous palm of the European shores of the Mediterranean, and still abundant in the south of Spain and in Sicily) is nowhere to be met with.

That the Date-Palm, however, has not thoroughly acclimatized itself is shown by the fact that it is only during very exceptional seasons and in a few specially protected spots that it is known to ripen its fruit.

Other plants which forcibly recall more tropical climates are the so-called Aloes (*Agave americana*) and the Prickly Pears (*Opuntia Ficus-indica*), which may be seen everywhere in the neighbourhood of the villages rooted in the crevices of the driest and most exposed rocks or forming impenetrable hedges for the gardens. Though there is abundant evidence to show that these plants had been introduced from Central America, they have here completely acclimatized themselves, flowering and ripening their fruit as if they had been truly natives.

Among the most important introductions from more southern latitudes are the Australian Eucalyptuses. The *Eucalyptus globulus* is planted round almost all the towns on the Riviera, and, as it is of amazingly rapid growth, has already attained in many places a great size. Though destitute of the graceful form of many of our European trees, it is still a tree of striking and often picturesque aspect. The foliage is of a glaucous tint, especially in the broad amplexicaul leaves of the younger trees; while the long pointed or sickle-shaped leaves of the older trees, suspended on slender petioles, and presenting their surfaces vertically to the wind, tremble like the leaf of the aspen in the gentlest breeze, and, though casting but little shade, impress us, like the murmuring of running water, with a pleasant sense of coolness in the sultry southern air.

Notwithstanding, however, the vigorous growth of the *Eucalyptus globulus*, and its apparently complete adaptation to the climate of the Riviera, there is still enough to keep us in mind of the fact that it is an exotic; for though the trees freely expand in the spring their beautiful white tassel-like flowers, the seeds do not ripen, and the cultivators find it necessary to import such as may be capable of germination.

Associated with the *Eucalyptus* is the beautiful Australian *Casuarina*. The tree is destitute of leaves, but the branches emit innumerable dark green pendulous shoots, jointed and striated like the stems of an *Equisetum*. These give to it the general aspect of a Conifer, and the whole tree impresses us by the graceful symmetry of its form and the elegant plumose habit of its singular pendulous ramification. Like the *Eucalyptus* it is of very rapid growth. It has already attained in Provence a height of some 30 or 40 feet; and when the wind rushes through its branches, the long melancholy sigh with which the tree responds is unlike the sound called forth by the same cause

in any other with which I am acquainted. The climate of the littoral parts of Provence and of Liguria is, indeed, eminently suited to the requirements of Australian trees and shrubs; and the gardens abound in Australian *Myrtaceæ*, *Proteaceæ*, and *Mimoseæ*.

The number of exotic plants met with in many of the gardens gives these a special interest; and when to his general appreciation of horticulture the proprietor adds a scientific knowledge the result possesses a value which may in vain be sought for in countries where the defects of climate have to be compensated for by artificial protection.

The garden at Antibes, which had belonged to our late distinguished and lamented Foreign Member, M. Thuret, affords an example of what might be done by a scientific botanist in a climate like that of the Riviera; for there the plants of more southern latitudes find conditions suited to their perfect development, and offer admirable subjects for scientific study. In his garden near Mentone, Dr. Henry Bennett has brought together many species from more southern countries, and has covered the parched and rugged cliffs with a flourishing exotic vegetation. But it is at Mortola, between Mentone and Ventimiglia, in the gardens of the Palazzo Orengo, belonging to our Fellow, Mr. Thomas Hanbury, that may be found realized the most perfect combination of the native flora and natural beauty of this wonderful coast with an exotic vegetation which only scientific knowledge and appreciative skill could have succeeded in bringing together.

The gardens of the Palazzo Orengo are spread over the southern slope of a hill and extend to the very shores of the sea; and the visitor meets at every step some unfamiliar form of vegetation, as he sees mingled with the beautiful flora of the Riviera the plants of Australia, of Southern and Central America, of Northern, Western, and Southern Africa, and of China and Japan, all growing with a freedom and a vigour which could scarcely be surpassed in their native lands.

I have thus attempted to sketch for you by a few broad outlines some of the most striking features of the vegetation of a portion of the Mediterranean shores, limited in its extent, but replete with interest—a land where some of the most significant phenomena of geographical distribution present themselves to the botanist; for though belonging to the European area, it exhibits in its climate and in the southern character of its vegetation an

obvious link between the temperate and the tropical zones. My sketch has been necessarily imperfect; but there is yet enough in it to show that on the northern shores of the Mediterranean, and within easy access of our own, there is a region in whose singularly interesting flora the botanist may still find ample material for study, and from which, amid scenes of unrivalled beauty, the painter may derive some of his noblest inspirations.

On the Application of the Results of Pringsheim's recent Researches on Chlorophyll to the Life of the Lichen*. By GEORGE MURRAY, F.L.S., Assistant in the Botanical Department, British Museum.

[Read June 3, 1880.]

SHORTLY stated, the result of these researches has been to take away from chlorophyll the function ascribed to it of decomposing carbonic acid under the influence of sunlight, and to assign to it the position of a screen for concomitant protoplasm which is now to be considered the active agent in effecting this decomposition. In furtherance of these observations, it was suggested by Dr. Vines ('Nature,' vol. xxi. p. 86) that by the interposition of an artificial chlorophyll screen the protoplasm of fungi or even of animals (see Geddes, "Functions of Chlorophyll in the Green Planariæ"†) might be excited to the decomposition of carbonic acid, and to the formation of starch from carbonic acid and water. Prof. Lankester ('Nature,' vol. xxi. p. 559, footnote) objects to this experiment, on the grounds of "the definitely characteristic chemical activities acquired by protoplasm in different organisms;" and suggests as a more decisive trial the same experiment with an etiolated plant. While agreeing as to the fairness of this suggestion, it yet seems to me that the experiment

* The researches referred to are "Ueber Lichtwirkung und Chlorophyll-Function in der Pflanze" and "Ueber das Hypochlorin und die Bedingungen seiner Entstehung in der Pflanze," July and November respectively, 1879, 'Monatsber. d. Königl. preuss. Akad. der Wissensch. zu Berlin;' noticed in 'Nature,' vol. xxi. at p. 85, by Dr. Sidney Vines, and at p. 557, by Prof. Lankester.

† Journ. Roy. Micr. Soc. 1879, p. 161: abstracted from the Comptes Rendus, 1878, vol. lxxxvii. p. 1095. See also Geddes, Proc. Roy. Soc. 1879, vol. xxviii. pp. 449 *et seq.*, "Observ. on the Physiol. and Histol. of *Convoluta Schulzei*."

proposed by Dr. Vines is a very reasonable one when considered in the light of what apparently takes place in lichens. As Prof. Lankester points out in the same article, "Light which has traversed a solution of chlorophyll is still efficient in exciting the plant-cell (whatever part of the cell may be called into play) to the decomposition of CO_2 and the liberation of O."

This proposed experiment appears to me to be proceeding naturally in lichens. We have in them the fungal tissues, as the body of the thallus and the chlorophyll screen, in the gonidial layer; that is, the chlorophyll is in one system of cells and the protoplasm apparently affected by it in another which is in contact. The light which traverses the chlorophyll-containing gonidial layer excites in the fungal tissues the decomposition of carbonic acid. In evidence of this I would point to the plentiful occurrence of starch, or rather lichenin, a substance of the same chemical composition as starch ($\text{C}_{12}\text{H}_{10}\text{O}_{10}$), and formed from it, according to Masche (Journ. prakt. Chemie, lxi. p. 7), by the action of the free acids of the plant. Further, I venture to submit that this process tends to explain the nature of the consortism of the fungal and algal elements in the autonomous lichen, and to support the well-known views of Schwendener*.

A Synopsis of *Aloineæ* and *Yuccoideæ*.

By J. G. BAKER, F.R.S.

[Read January 15, 1880.]

I HAVE now come to that portion of my monograph of *Liliaceæ* that deals with the Aloes and Yuccas, a set of plants well known in gardens, but which, from their large size and often succulent character, are represented very sparingly in herbaria, and have been almost totally passed over by travelling collectors of dried specimens. They fall sharply into two tribes, which are marked by well-defined botanical characteristics, which are correlated with a completely different geographical dispersion. Of the Aloes, which are characterized by their gamophyllous perianth and thick fleshy leaves, there are nearly two hundred species, which are strictly confined to the Old World. Of the *Yuccoideæ*, which

* "Untersuchungen über den Flechtenthallus," in Nägeli's 'Beiträge zur wissenschaftlichen Botanik,' 4te Heft, 1868.

are characterized by a polyphyllous perianth, and of which the leaves are never thick and fleshy, there are nearly fifty species, all of which belong exclusively to America.

Of the Aloes, one species, *Aloe vera* or *vulgaris*, belongs to the Mediterranean region, and was one of the first plants that was definitely individualized by writers on natural history. By the beginning of the seventeenth century about twenty of the Cape species had already been introduced into European gardens. Most of these are well figured and described in the 'Prælua' of Commelinus, published at Amsterdam in the year 1703, and a few others are noticed in the 'Hortus Medicus Amstelodamensis' of the same author, and the 'Hortus Elthamensis' of Dillenius. Linnæus seems to have paid very little attention to Aloes. In his herbarium the tribe is solely represented by two leafless racemes; and in his 'Species Plantarum' he reduces the number of species of genuine Aloes to seven, massing under the name of *Aloe perfoliata* several which his predecessors had clearly characterized and distinguished. Philip Miller knew them better; and in the sixth edition of his 'Gardener's Dictionary,' published in 1771, names and notices twenty-two species. In the first volume of the 'Encyclopédie,' eighteen years later, Lamarck worked them up afresh, but adds very little; and this is also the case with Willdenow ten years later. Thunberg, who did so much for Cape botany, also attended to the Aloes very little, and his synopsis of them is poor and brief. Between 1790 and 1800 a great many new species were introduced into Europe by Masson; and in 1801 Haworth published a monograph in the seventh volume of the 'Transactions' of our own Society, in which he raises the number of species to sixty. In 1812 Haworth again worked them up more fully in his 'Synopsis Plantarum Succulentarum,' in which he adopts Duval's two new genera *Gasteria* and *Haworthia*. In his 'Supplementum' of 1819 and 'Revisiones' of 1821 a few new species are added. Between 1820 and 1830 Bowie introduced a large number of new Cape species. These were cultivated at Kew and named and described by Haworth from time to time in Taylor's 'Philosophical Magazine.' Of most of these introductions of Bowie's there are original coloured drawings in the Kew collection which have never been published; and these I have often utilized here. The great cultivator of Aloes upon the continent over the half-century extending from 1810 to 1860 was Prince Salm-Reifferschied-Dyck. His 'Cata-

logue' of 1817 and 'Hortus Dyckensis' of 1834 contain many notes upon them of great value; but these are almost entirely superseded by his valuable monograph in quarto, which came out in parts from time to time from 1836 to 1863, and contains full descriptions and coloured figures of 150 forms, which represent about 120 species as here understood. Since the time of this great work a large number of new Cape species have been discovered and imported, mainly by Mr. Thos. Cooper of Redhill, who travelled through the Colony from 1858 to 1862, collecting for the late Mr. Wilson Saunders and the Royal Horticultural Society. Several of Mr. Cooper's novelties have been figured in the 'Botanical Magazine' and 'Refugium;' but there are several others which have flowered which have not yet been figured, and others which we know as yet only in an undeveloped condition. Very few of the Cape species which have ever been imported have been lost; so that there are few groups of which a larger proportion of the known species are in cultivation in our gardens at the present time. An Aloe has long been known in Abyssinia; and the explorations of late years have shown that there are a considerable number of endemic species in the highlands of Tropical Africa. Welwitsch in Angola found several true Aloes and one *Haworthia*. Schimper has discovered three or four additional species in Abyssinia; Schweinfurth two or three in the very heart of the continent; and others have been gathered by Barter in Upper Guinea, Kirk in Zambesi-land, and Balfour in Rodriguez; and no doubt the collectors of the future will add to the muster-roll materially. Of these Tropical-African species it is only those from Abyssinia that are known in cultivation. The new ones have been figured and fully described recently by Todaro in his 'Hortus Botanicus Panormitanus.' Several Arabian species imperfectly described by Forskahl in 1775 have not been refound and have never been characterized so that they can be properly classified. And there is a species in the island of Socotra, which appears to be endemic, of which the flower is still unknown. My descriptions were mainly made in 1872 from the living specimens in the Kew collection. Mr. Wilson Saunders accumulated a fine collection at Beigate which is now dispersed. The most extensive private collection in England at the present time is that of Mr. J. T. Peacock, of Hammersmith. A considerable portion of this has been for the last year liberally lent by him for exhibition at Kew, and has been placed, along with a series of Cactuses and

Agaves, in the south wing of the large temperate house; and I have found it very useful in preparing this present synopsis.

Of the *Yuccas*, three species were known long before the time of Linnæus. A large number of new forms from Mexico, California, and the Western United States have been made known during the last twenty years. Most of these have been introduced into cultivation; but many of them are only known in an undeveloped flowerless condition. Mr. Wilson Saunders made a speciality of the genus, and got together at Reigate a fine collection, of which the forms that flowered will be found figured in the fifth volume of the 'Refugium' (tabs. 313 to 325). Dr. Engelmann's monograph, which appeared in the third volume of the 'Transactions of the Academy of Science of St. Louis' in 1873, is a very valuable accession to our knowledge of the genus. The flower is fertilized by a moth, and the fruit, which Dr. Engelmann has shown to furnish excellent distinctive characters, is hardly ever produced in cultivation, the plants being capable of being preserved for an indefinite time by vegetative reproduction. The same volume of the 'Transactions' of the St. Louis Academy contains a full account and figure by Mr. Riley of the fertilizing moth (*Pronuba yuccasella*) and the manner in which its work is performed. In the systematic portion of my synopsis references will be found to the papers on the genus by Carrière, Lemaire, Hemsley, Karl Koch, and myself, which have appeared in the horticultural periodicals.

Dasyllirion and *Beaucarnea*, which resemble *Yucca* in general habit, but have minute polygamo-dioicous flowers, belong entirely to Mexico and the Southern United States. Several species are in cultivation; but many others are imperfectly known; and both here and in *Yucca* there is ample scope for further exploring work. *Herreria*, which is a climber with prickly stems, belongs entirely to Extratropical South America and the plateau of Central Brazil.

The only striking deviation from typical Liliaceous structure shown in this portion of the order is in the polygamo-dioicous flowers of *Dasyllirion* and *Beaucarnea* and the indehiscent one-celled one-seeded capsule of the former genus.

Of the 195 known Aloes, about 170 are natives of the Cape. Of the 47 Yuccoideæ, 44 belong to the northern and 3 to the southern half of the American continent.

CLAVIS TRIBUUM ET GENERUM.

Tribus ALOINÆ. Frutices, arbores vel suffrutices, fructu capsulari, perianthio gamophyllo, foliis crassis carnosis. Incolæ orbis veteris.

1. ALOE. Perianthium rubro-luteum, tubo recto vel leviter recurvato, segmentis elongatis. Genitalia perianthio æquilonga vel exserta. *C. B. Spei, Afr. trop., Regio medit.*

2. GASTERIA. Perianthium rubrum, tubo curvato deorsum ventricosum, sursum cylindrico, segmentis brevibus. Genitalia perianthio breviora. *C. B. Spei.*

3. HAWORTHIA. Perianthium albidum, limbo bilabiato. Genitalia perianthio breviora. *C. B. Spei, Angola.*

4. APICRA. Perianthium albidum, limbo brevi regulari. Genitalia perianthio breviora. *C. B. Spei.*

Tribus YUCCOIDEÆ. Frutices, arbores vel suffrutices, perianthio polyphyllo, foliis elongatis duris nunquam carnosis. Incolæ orbis novis.

5. YUCCA. Flores magni hermaphroditi. Perianthium album, segmentis ovatis vel oblongis, venulis dispersis. Stylus sæpissime crassus, stigmatibus tribus quadratis emarginatis. Erectæ. *Amer. bor., Mexico, Guatemala.*

6. HESPERALOE. Flores magni hermaphroditi. Perianthium albidum, segmentis lanceolatis, venulis in carinam concretis. Stylus gracilis, stigmatibus capitato. Erecta. *Texas.*

7. HERRERIA. Volubiles, floribus parvis viridulis, seminibus discoideis. *Amer. merid.*

8. BEAUCARNEA. Flores parvi polygamo-dioici. Capsula trilocularis. Folia nunquam spinoso-dentata. *Amer. bor., Mexico.*

9. DASYLIRION. Flores parvi polygamo-dioici. Capsula unilocularis indehiscens. Folia sæpe spinoso-dentata. *Amer. bor., Mexico.*

1. ALOE (*Tourn.*), *Linn.*

Linn. Gen. no. 430, *ex parte*; *Duval, Pl. Succ. Hort. Alenc.* 6; *Haw. Syn.* 74; *Salm-Dyck, Monog. Aloe, ex parte*; *Endlich. Gen.* no. 1115, *ex parte*; *Kunth, Enum.* iv. 492, *ex parte*.—*Kumara, Medic. Theod.* 69, t. 4.—*Rhipidodendron, Willd. in Berl. Mag.* v.

164.—Pachidendron, *Haw. Revis.* 35.—Bowiea, *Haw. in Phil. Mag.* 1824, 199, non *Harv.*—Catevala, *Medic. Theod.* 67, *ex parte.*

Perianthium gamophyllum rubro-luteum cylindricum vel clavatum rectum vel leviter recurvatum, tubo brevi campanulato vel elongato cylindrico, segmentis subconformibus viridi vittatis diu conniventibus. *Stamina* 6 hypogyna perianthio æquilonga vel longiora, 3 paulo breviora, filamentis subulatis, antheris parvis oblongis versatilibus. *Ovarium* oblongum sessile triloculare, ovulis in loculo crebris superpositis; *stylus* filiformis elongatus sæpe leviter declinatus, stigmatibus capitato. *Capsula* oblonga coriacea loculicido-trivalvis. *Semina* multa angulata vel subcompressa sæpe alata, testa membranacea atro-brunnea, albumine carnosio, embryone cylindrico. *Plantæ acaules vel caulescentes fruticosaæ vel raro arborescentes, foliis crassis carnosis sæpe dense rosulatis dentibus marginalibus spinosis corneis præditis, pedunculis simplicibus vel ramosis bracteis vacuis paucis vel pluribus præditis, floribus racemosis, pedicellis basi bracteatis solitariis apice articulatis.*

Subgenus EUALOE. Perianthium rectum. Genitalia perianthio æquilonga vel exserta. Folia multifaria rarissime disticha.

Acaules.

Genitalia perianthio æquilonga.

Folia linearia minute denticulata.

Folia disticha..... 1. *A. Cooperi.*

Folia multifaria 2. *A. myriacantha.*

Folia lanceolata dentata.

3. *A. aristata.* 4. *A. pratensis.* 5. *A. humilis.* 6. *A. virens.*

Genitalia distincte exserta.

7. *A. Bowiea.* 8. *A. Ecklonis.* 9. *A. longistyla.*

10. *A. Kraussii.*

Breviter caulescentes, foliis dense rosulatis immaculatis.

Folia linearia denticulata. 11. *A. micracantha.*

Folia lanceolata dentata.

Folia distincte verticaliter lineata.

12. *A. lineata.* 13. *A. Schimperii.*

Folia haud vel vix lineata.

14. *A. brevifolia.* 15. *A. Serra.* 16. *A. glauca.*

17. *A. heteracantha.* 18. *A. Perryi.*

Folia parva ensiformia dentata.

19. *A. chinensis.* 20. *A. crassipes.*

Folia magna ensiformia dentata.

21. *A. angolensis*. 22. *A. lomatoophylloides*.

Folia integra oblongo-lanceolata 23. *A. striata*.

Breviter caulescentes, foliis densis vel subdensis copiose albo maculatis.

Folia lanceolata, dentibus minutis.

24. *A. serrulata*. 25. *A. tenuifolia*.

26. *A. macrocarpa*. 27. *A. albocincta* × *grandidentata*.

Folia lanceolata, dentibus majoribus.

Flores capitati.

28. *A. Saponaria*. 29. *A. latifolia*.

Flores racemosi.

30. *A. obscura*. 31. *A. commutata*. 32. *A. Greenii*.

33. *A. grandidentata*. 34. *A. gasterioides*. 35. *A. tricolor*.

36. *A. agavæfolia*. 37. *A. zebрина*. 38. *A. platyphylla*.

Flores ignoti..... 39. *A. macracantha*.

Folia densa ensiformia.

40. *A. microstigma*. 41. *A. Barteri*.

42. *A. constricta*.

Folia sublaxa ensiformia.

43. *A. consobrina*. 44. *A. spicata*.

Longe caulescentes, foliis laxè dispositis immaculatis.

Sarmentosæ, foliis linearibus.

45. *A. ciliaris*. 46. *A. tenuior*. 47. *A. striatula*.

48. *A. Macowani*.

Suberectæ, foliis ensiformibus.

49. *A. gracilis*. 64. *A. arborescens*, var. *frutescens*.

50. *A. Atherstoni*. 51. *A. nitens*.

Folia ovato-lanceolata.

52. *A. distans*. 53. *A. mitriformis*.

54. *A. albispina*. 55. *A. nobilis*.

Longe caulescentes, foliis dense rosulatis immaculatis (vel interdum, præsertim junioribus, parce irregulariter maculatis).

Genitalia perianthio subæquilonga.

Folia lanceolata.

56. *A. cæsia*. 57. *A. palmiformis*. 58. *A. andongensis*.

Folia ensiformia.

59. *A. succotrina*. 60. *A. purpurascens*. 61. *A. littoralis*.

62. *A. abyssinica*. 63. *A. Schweinfurthii*. 64. *A. arborescens*.

65. *A. pluridens*.

Genitalia distincte exserta. Folia ensiformia.

66. *A. vera*. 67. *A. drepanophylla*. 68. *A. sigmoidea*.
69. *A. Salmodyckiana*. 70. *A. chloroleuca*. 71. *A. platylepis*.
72. *A. speciosa*.

Arborescentes, trunco alto ramosissimo.

73. *A. dichotoma*. 74. *A. Bainesii*.

Subgenus GONIALOE. Perianthium rectum. Genitalia perianthio æquilonga. Folia trifaria copiose albo maculata.

Species sola 75. *A. variegata*.

Subgenus PACHIDENDRON. Perianthium leviter recurvatum. Genitalia longe exserta distincte declinata. Omnes longe caulescentes, foliis multifariis immaculatis.

Folia lanceolata..... 76. *A. Bolusii*. 77. *A. ferox*.

Folia ensiformia.

78. *A. africana*. 79. *A. supralævis*. 80. *A. Thraskii*.

Subgenus KUMARA, *Medic.* (Rhipidodendron, *Willd.*). Arborescens, trunco ramosissimo, foliis distichis. Perianthium rectum, segmentis interioribus liberis.

Species sola 81. *A. plicatilis*.

Species minus cognitæ.

82. *A. pendens*. 83. *A. inermis*. 84. *A. arabica*.
85. *A. claviflora*. 86. *A. falcata*.

1. *A. COOPERI*, *Baker in Gard. Chron.* 1874, 628; *Bot. Mag.* t. 6377. —*A. Schmidiana*, *Regel in Gartenfl.* 1879, 97, tab. 970. Acaulis, foliis rudimentariis 3-4 deltoideis scariosis, productis 8-10 distichis falcatis linearibus exterioribus sesquipedalibus vel bipedalibus supra basin 6-8 lin. latis viridibus profunde canaliculatis facie parce maculatis obscure lineatis medio 1½-2 lin. crassis dorso ad basin carinatis deorsum copiose albido maculatis, margine albido angusto cartilagineo, dentibus minutis crebris albidis deltoideo-cuspidatis. Scapus simplex sesquipedalis vel bipedalis, superne bracteis pluribus vacuis magnis lanceolatis instructus. Racemus superne densus inferne laxus 3-6 poll. longus 3¼-4 poll. diam., pedicellis inferioribus 1-2 poll. longis, bracteis lanceolatis acutis 9-12 lin. longis. Perianthium cylindricum 15-18 lin. longum, tubo brevissimo, segmentis lanceolatis apice viridulis. Genitalia inclusa. *C. B. Spei in ditione orientali*, Burchell 4482! 4564! *Natal*, Cooper 1193! 3623 *Ab A. micracantha*, Haw. caudice nullo et foliis distichis dorso carinatis recedit.

2. *A. MYRIACANTHA*, *Roem. et Schultes, Syst.* vii. 704; *Kunth, Enum.* iv. 515.—*Bowiea myriacantha*, *Haw. in Phil. Mag.* 1827, 122. Acaulis, foliis exterioribus 3–4 rudi mentariis deltoideis scariosis, productis 10–12 multifariis falcatis linearibus 5–6 poll. longis 4–5 lin. latis viridibus glauco tinctis facie profunde canaliculatis dorso convexis subcarinatis maculis minutis albidis decoratis, margine albido angusto cartilagineo, dentibus minutis crebris albidis deltoideo-cuspidatis. Pedunculus gracilis simplex pedalis, bracteis pluribus vacuis lanceolatis præditus. Racemus densus capitatus, expansus 2 poll. diam., pedicellis 4–6 lin. longis, bracteis lanceolatis acutis pedicello æquilongis vel longioribus. Perianthium cylindricum pallide rubrum 8–9 lin. longum leviter recurvatum, tubo brevissimo, segmentis lanceolatis acutis apice viridulis, obscure bilabiatis. Genitalia perianthio æquilonga. *C. B. Spei in ditione orientali*, Bowker! Hutton! *Natal*, Reade 133!

3. *A. ARISTATA*, *Haw. in Phil. Mag.* Oct. 1825, 280.—*A. longiaristata*, *Roem. et Schultes, Syst.* vi. 284; *Salm-Dyck, Aloe*, sect. xv. fig. 7; *Kunth, Enum.* ix. 518. Subcaulis. Rosula foliorum 3–4 poll. diam. Folia 50 densissime rosulata omnia ascendencia lanceolata 3–4 poll. longa 6–8 lin. lata viridia immaculata haud lineata facie plana superne parce aculeato-tuberculata, medio $1\frac{1}{2}$ lin. crassa, dorso dimidio superiore copiose tuberculato-aculeata, apice in aristam pellucidam 5–6 lin. longam attenuata, aculeis marginalibus copiosis albidis deltoideis $\frac{1}{2}$ lin. longis. Scapus simplex pedalis, bracteis paucis vacuis instructus. Racemus simplex laxus 4–6 poll. longus, expansus 3–4 poll. diam., pedicellis subpatentibus 13–18 lin. longis, bracteis lanceolatis acuminatis 4–6 lin. longis. Perianthium rubrum cylindricum 14–16 lin. longum, segmentis dorso viridulis tubo longioribus. Genitalia perianthio æquilonga. *C. B. Spei in ditione orientali*, ad 2900 pedes in montibus *Snewbergen ascendens*, Burke! *Zeyher* 4186! *MacOwan* 1944! In hortos anno 1824 a *Bowie* introducta.

Var.? *LEIOPHYLLA*, *Baker*. Folia tenuiora minora (2–2½ poll. longa, deorsum 5–6 lin. lata) facie nullo modo tuberculato-aculeata, aculeis marginalibus et dorsalibus minoribus gracilioribus. Flores ignoti. *C. B. Spei*, *Hort. Cooper*, anno 1879!

4. *A. PRATENSIS*, *Baker*. Acaulis, foliis 20 vel ultra dense rosulatis ovato-lanceolatis 4–6 poll. longis basi 15–21 lin. latis viridibus glauco tinctis immaculatis facie subplanis dorso convexis medio 2 lin. crassis, dentibus marginalibus lanceolato-deltoideis corneis brunneis leviter falcatis $1\frac{1}{2}$ –2 lin. longis. Pedunculus simplex pedalis et ultra, bracteis perpluribus vacuis magnis longe cuspidatis præditus. Racemus simplex densus semipedalis, expansus 4 poll. diam., pedicellis 12–18 lin. longis, bracteis lanceolatis longe cuspidatis pedicello æquilongis. Perianthium clavatum 15–18 lin. longum, segmentis lanceolatis tubo angusto longioribus. Genitalia perianthio æquilonga. *C. B. Spei*, hort. *Cooper* anno 1878! *In rupestribus summi Boschberg*, alt. 4500 pedum, *MacOwan* 1896!

5. *A. HUMILIS*, *Miller, Gard. Dict.* edit. vi. no. 10; *Thunb. Diss.* no. 6; *Jacq. Hort. Schoen.* t. 420.—*A. perfoliata*, var. *humilis*, *Linn. Sp.* 458.—*A. echinata*, *Willd. Enum.* 385; *Salm-Dyck, Aloe*, sect. xv. fig. 2; *Kunth, Enum.* iv. 516.—*A. humilis*, &c., *Commel. Prælucl.* t. 26; *Rar.* t. 46. Acaulis. Folia 30–40 dense rosulata omnia ascendunt lanceolata acuminata 3–4 poll. longa basi 6–8 lin. lata glauco-viridia obscure lineata facie deorsum plana sursum leviter concava parce tuberculato-aculeata, medio 3 lin. crassa, dorso convexa magis lineata tuberculis pallidis irregulariter seriatis superioribus cuspidatis instructa, aculeis marginalibus deltoideo-cuspidatis pallidis 1 lin. longis. Pedunculus simplex subpedalis, bracteis multis lanceolatis vacuis præditus. Racemus laxis simplex semipedalis, expansus 2–2½ poll. diam., pedicellis 9–12 lin. longis, bracteis lanceolatis acutis pedicello æquilongis. Perianthium cylindricum splendide rubrum 18 lin. longum, tubo 3–4 lin. longo, segmentis lanceolatis apice viridulis. Genitalia perianthio æquilonga. *C. B. Spei.* *A. TUBERCULATA*, *Haw. in Trans. Linn. Soc.* vii. 16; *Syn.* 84, est forma nana.

Var. *CANDOLLEI*, *Baker*.—*A. humilis*, *DC. Plantes Grasses*, t. 39; *Salm-Dyck, Aloe*, sect. xv. fig. 1; *Kunth, Enum.* iv. 516. Folia viridiora distincte lineata dorso minus tuberculata, aculeis paucioribus minoribus. Pedunculus minus bracteatus. *C. B. Spei.*

Var. *A. INCURVA*, *Haw. Syn.* 85; *Salm-Dyck, Aloe*, sect. xv. fig. 3; *Kunth, Enum.* iv. 517.—*A. humilis*, var. *incurva*, *Ker in Bot. Mag.* t. 828.—Major, foliis glauco-viridibus deorsum deltoideis minus acuminatis apice incurvatis, aculeis copiosis, dorsalibus multis irregulariter seriatis. *C. B. Spei.*

Var. *A. ACUMINATA*, *Haw. Syn.* 84; *Kunth, Enum.* iv. 517.—*A. humilis*, *Ker in Bot. Mag.* t. 757. Folia ovato-lanceolata 4–5 poll. longa 15–18 lin. lata minus acuminata quam in typo glaucescentia, aculeis majoribus, marginalibus pallidis lanceolato-deltoideis 2–2½ lin. longis. *C. B. Spei.* Hort. Chelsea, anno 1776! (herb. Mus. Brit.). *A. SUBTUBERCULATA*, *Haw. in Phil. Mag.* Oct. 1825, 280, est forma minor aculeis minoribus crebrioribus; et *A. SUBRECTA*, *Haw. Syn.* 84, est forma major foliis 6–7 poll. longis.

Var. *MACILENTA*, *Baker*. Folia tenuiora purpureo tincta 3–4 poll. longa medio 2 lin. crassa basi 8–9 lin. lata facie profunde canaliculata, tuberculis facialibus paucis, dorsalibus numerosis. *C. B. Spei.* V. v. in hort. Peacock.

6. *A. VIRENS*, *Haw. in Trans. Linn. Soc.* vii. 17; *Synops.* 83; *Ker in Bot. Mag.* t. 1355; *Roem. et Schultes, Syst.* vii. 686; *Salm-Dyck, Aloe*, sect. xv. fig. 8; *Kunth, Enum.* iv. 518. Subcaulis. Folia 30–40 dense rosulata lanceolata acuminata semipedalia e basi 1 poll. lata ad apicem attenuata viridia haud lineata medio 3–4 lin. crassa facie parce dorso copiose irregulariter albo maculata superne tuberculata, dentibus marginalibus patulis deltoideis pallidis 1½–2 lin. longis. Scapus simplex gracilis

semipedalis. Racemus laxus semipedalis simplex, expansus 3-4 poll. diam., pedicellis rubellis 15-18 lin. longis, bracteis lanceolatis acutis 5-6 lin. longis. Perianthium splendide rubrum cylindricum 21-24 lin. longum, laciniis lanceolatis apice viridulis tubo æquilongis. Stamina perianthio æquilonga. Stylus demum exsertus. *C. B. Spei*, ante 1790 introducta.

Var. *MACILENTA*, *Baker*. Minor, foliis tenuioribus purpureo tinctis facie canaliculatis. *C. B. Spei*. V. v. in hort. Peacock.

7. *A. BOWIEA*, *Schultes fil. Syst. Veg.* vii. 704; *Salm-Dyck, Aloe*, sect. xiv. fig. 1; *Kunth, Enum.* iv. 515.—*Bowiea africana*, *Haw. Phil. Mag.* 1824, 299, 1827, 214; *A. DC. Pl. Rar. Hort. Genev.* fasc. vii. 21, t. 2. Acaulis dense rosulata. Folia 30-40 omnia ascendente e basi deltoidea lanceolato-acuminata 4-5 poll. longa basi 6-8 lin. lata carnosae facie planiuscula glauco-viridia inermis, dorso rotundata maculis parvis albidis copiosis decorata basi brunneo striata, aculeis marginalibus minutis albidis deltoideis. Pedunculus gracilis simplex subpedalis, bracteis paucis vacuis lanceolatis instructus. Racemus laxus semipedalis 20-30-florus, expansus 18-21 lin. diam., pedicellis brevissimis, bracteis lanceolatis acutis 3-4 lin. longis. Perianthium clavatum albo-viridulum rubro tinctum 6-7 lin. longum, tubo campanulato, segmentis lanceolatis. Genitalia 3-4 lin. exserta. *C. B. Spei*, anno 1822 a *Bowie* introducta. V. v. florif. in hort. Saunders.

8. *A. ECKLONIS*, *Salm-Dyck, Aloe*, sect. xxi. fig. 2. Subacaulis. Folia dense rosulata ensiformia 10-12 poll. longa e basi 15-18 lin. lata ad apicem sensim attenuata immaculata haud lineata glaucescentia deorsum plana superne canaliculata, exteriora recurvata, dentibus crebris patulis minutis deltoideis albidis. Pedunculus subpedalis simplex, bracteis pluribus vacuis præditus. Racemus densus capitatus, expansus 3 poll. diam., pedicellis cernuis 15-18 lin. longis, bracteis lanceolatis acutis viridibus 5-6 lin. longis. Perianthium oblongum aurantiacum 9-10 lin. longum, tubo brevi infundibulari, segmentis elongatis lanceolatis apice viridibus. Genitalia exserta. *C. B. Spei*. *Ecklon* versus annum 1836 in hortos europæos introduxit.

9. *A. LONGISTYLA*, *Baker*. Acaulis, habitu omnino *A. humilis*. Folia circiter 30 dense rosulata lanceolata 4-6 poll. longa 9-10 lin. lata viridia immaculata facie lævia dorso parce irregulariter tuberculato-aculeata, apice pungente, dentibus marginalibus deltoideis pallide brunneis subdistantibus 1½ lin. longis. Scapus valde robustus simplex semipedalis. Racemus simplex densus semipedalis, expansus 4-4½ poll. diam., pedicellis brevissimis, bracteis deltoideis vel lanceolatis acutis 6-12 lin. longis. Perianthium rubrum 21-24 lin. longum, segmentis tubo 2-3plo brevioribus. Stamina breviter exserta. Stylus demum 6-9 lin. exsertus. *C. B. Spei in ditone orientali*, *Drège* 8640! *Graaf Reinet*, *Bolus* 689!

10. *A. KRAUSSII*, Baker. Acaulis. Folia 8–10 disticha suberecta linearia macera 4–5 poll. longa 5–6 lin. lata viridia immaculata haud lineata margine angustissimo albedo corneo minute denticulato. Pedunculus simplex 6–8-pollicaris deorsum aniceps, bracteis multis vacuis deltoideis acuminatis præditus. Racemus capitatus densus, expansus 2–2½ poll. diam., pedicellis ascendentibus 9–12 lin. longis, bracteis lanceolatis acuminatis pedicello duplo brevioribus. Perianthium luteum 5–6 lin. longum, tubo brevissimo, segmentis lanceolatis. Stamina perianthio æquilonga. Stylus distincte exsertus. *Natal*, Krauss 275! (Herb. Mus. Brit.)

11. *A. MICRACANTHA*, Haw. *Suppl.* 105; *Sims in Bot. Mag.* t. 2272; *Link et Otto, Ic.* 87, t. 40; *Roem. et Schultes, Syst.* vii. 797; *Salm-Dyck, Aloe*, sect. xxi. fig. 1. Brevisse caulescens. Folia 15–20 multifaria dense rosulata ascendente falcata linearia exteriora sesquipedia basi 9–12 lin. lata ad apicem acuminatum sensim attenuata viridia facie profunde canaliculata parce maculata dorso rotundata maculis copiosis albidis minutis prædita, margine albedo anguste cartilagineo dentibus minutis albis crebris deltoideo-cuspidatis. Scapus simplex pedalis superne bracteis pluribus vacuis præditus. Racemus simplex densus corymbosus, expansus 3½–4 poll. diam., pedicellis apice cernuis 1–2 poll. longis, bracteis lanceolatis acutis 9–12 lin. longis. Perianthium rubrum cylindricum 15–18 lin. longum, tubo brevissimo, segmentis lanceolatis apice viridibus. Genitalia perianthio æquilonga. *C. B. Spei*, a Bowie anno 1819 introducta.

12. *A. LINEATA*, Haw. *in Trans. Linn. Soc.* vii. 18; *Syn.* 79; *Roem. et Schultes, Syst.* vii. 689; *Salm-Dyck, Aloe*, sect. xvii. fig. 1; *Kunth, Enum.* iv. 520.—*A. perfoliata*, var. *lineata*, *Soland. in Ait. Hort. Kew.* i. 466. Caulis æstate semipedalis vel pedalis simplex 2 poll. diam. Folia dense rosulata lanceolata subpedalia basi 2 poll. lata e basi ad apicem sensim angustata pallide viridia immaculata ubique persistenter viridi lineata basi plana medio 3 lin. crassa superne canaliculata utrinque inermia, dentibus marginalibus crebris lanceolato-deltoideis rubellis 1½–2 lin. longis. Scapus simplex pedalis superne bracteatus. Racemus densus semipedalis, pedicellis apice cernuis 15–18 lin. longis, bracteis oblongo-lanceolatis pallidis pedicello duplo brevioribus. Perianthium rubellum cylindricum 15–18 lin. longum, segmentis lanceolatis elongatis. Genitalia perianthio æquilonga. *C. B. Spei*, ante annum 1789 introducta.

13. *A. SCHIMPERI*, *Todaro, Hort Bot. Panorm.* i. 70, t. 16.—*A. lineata*, var. *latifolia*, *A. Br. Ind. Sem. Hort. Berol.* 1869, 7. Brevisse caulescens, caule simplici. Folia 20 dense rosulata oblongo-lanceolata subpedalia 4 poll. lata glauco-viridia distincte lineata interdum obscure maculata medio 3–4 lin. crassa supra medium canaliculata, margine tenui rubello corneo dentibus minutis patulis deltoideis crebris irregularibus interdum confluentibus prædita. Scapus validus tripedalis superne valde ramosus, racemis densis corymbosis 4 poll. diam., pedicellis 12–15 lin. longis, bracteis minutis. Perianthium splendide rubrum 18–21 lin. longum, supra ovarium

distincte constrictum, segmentis brevibus. Genitalia inclusa. *Abyssinia*, Schimper. In Hort. Berol. anno 1869 culta.

14. *A. BREVIFOLIA*, *Miller, Gard. Dict.* edit. vi. No. 8; *DC. Plantes Grasses*, t. 81; *Haw. Syn.* 80; *Lindl. in Bot. Reg.* t. 996; *Salm-Dyck, Aloe*, sect. xvi. fig. 1, non *Haw. in Trans. Linn. Soc.* vii. 23.—*A. prolifera*, *Haw. in Trans. Linn. Soc.* vii. 16; *Kunth, Enum.* iv. 519.—*A. perfoliata* γ , *Lam. Enc.* i. 88.—*A. africana* caulescens foliis glaucis brevissimis, *Commel. Prælud.* t. 22. Brevis caulescens, caule simplicis. Rosula foliorum 6–7 poll. diam. Folia 30–40 densissima lanceolata 3–4 poll. longa basi 1 poll. lata glauca immaculata haud lineata facie inermia deorsum turgida vel plana sursum concava medio 3–4 lin. crassa dorso convexa superne parce tuberculato-aculeata, aculeis marginalibus lanceolato-deltaideis albidis 1–1½ lin. longis. Pedunculus simplex subpedalis bracteis multis vacuis præditus. Racemus densus semipedalis, expansus 2½–3 poll. diam., pedicellis apice cernuis 6–12 lin. longis, bracteis lanceolatis acutis pedicello brevioribus. Perianthium rubrum cylindricum 15–18 lin. longum, segmentis lanceolatis tubo longioribus. Genitalia perianthio æquilonga. *C. B. Spei.*

Var. *POSTGENITA*, *Roem. et Schultes, Syst.* vii. 1714; *Kunth, Enum.* iv. 519.—*A. prolifera*, var. *major*, *Salm-Dyck, Cat.* 23; *Haw. Suppl.* 44, *Major*, foliis 4–5 poll. longis, deorsum 15–18 lin. latis.

Var. *DEPRESSA*, *Haw. in Trans. Linn. Soc.* vii. 16; *Syn.* 80, excl. syn.; *Salm-Dyck, Aloe*, sect. xvi. fig. 3; *Kunth, Enum.* iv. 519.—*A. africana* caulescens foliis glaucis brevioribus, etc., *Commel. Prælud.* t. 21.—*A. perfoliata* β , *Lam. Ency.* i. 88. *Major*, foliis semipedalibus deorsum 1½–2 poll. latis facie interdum parce tuberculato-maculata. Pedunculus sesquipedalis vel bipedalis, floribus paulo majoribus. *C. B. Spei.*

15. *A. SERRA*, *DC. Plantes Grasses*, t. 81; *Jacq. Fragm.* t. 61; *Haw. Suppl.* 44; *Roem. et Schultes, Syst.* vii. 687; *Kunth, Enum.* iv. 519. Subcaulis vel breviter caulescens. Rosula foliorum 9–12 poll. diam. Folia 30–40 dense rosulata lanceolata 3–5 poll. longa deorsum 12–18 lin. lata glauca immaculata haud lineata seniora purpureo tincta facie inermia basi turgida sub apicem concava medio 3–4 lin. crassa, dorso concava apice parce tuberculato-aculeata, aculeis marginalibus crebris deltaideis albidis 1–1½ lin. longis in lineam albidam corneam basi confluentibus. Scapus simplex sesquipedalis vel bipedalis, bracteis vacuis multis præditus. Racemus simplex densus semipedalis et ultra, expansus 3–4½ poll. diam., pedicellis 6–12 lin. longis, bracteis lanceolatis acutis 6–9 lin. longis. Perianthium cylindricum splendide rubrum 18 lin. longum, segmentis tubo longioribus. Genitalia demum breviter exserta. *C. B. Spei*, in hortos nostros ante annum 1818 introducta. Ab *A. brevifolia* recedit aculeis crebrioribus in marginem corneum albidum confluentibus.

16. *A. GLAUCA*, *Miller, Gard. Dict.* edit. vi. No. 16; *Haw. in Trans. Linn. Soc.* vii. 18; *Syn.* 79; *Roem. et Schultes, Syst.* vii. 690; *Salm-Dyck*,

Aloe, sect. xvii. fig. 2; *Kunth, Enum.* vi. 520.—*A. rhodocantha*, *DC. Plantes Grasses*, t. 44; *Gawl. in Bot. Mag.* t. 1278. Breviter caulescens, caule simplici æstate semipedali vel pedali $1\frac{1}{2}$ –2 poll. diam. Folia 30–40 dense rosulata exteriora haud recurvata lanceolata 6–8 poll. longa e basi $1\frac{1}{2}$ –2 poll. lata ad apicem sensim angustata intense glauca immaculata obscure verticaliter lineata medio 3–4 lin. crassa facie supra basin leviter concava dorso apice parce tuberculato-aculeata, dentibus marginalibus deltoideis inæqualibus rubro-brunneis patulis 1 – $1\frac{1}{2}$ lin. longis. Pedunculus simplex pedalis vel sesquipedalis bracteis multis vacuis magnis præditus sublaxus semipedalis vel pedalis, expansus $3\frac{1}{2}$ –4 poll. diam., pedicellis apice cernuis 1 – $1\frac{1}{2}$ poll. longis, bracteis deltoideis 6–9 lin. longis. Perianthium pallide rubrum cylindricum 15–16 lin. longum, tubo subnullo, segmentis elongatis apice viridibus. Genitalia perianthio æquilongæ. *C. B. Spei*, anno 1731 introducta.

Var. *MURICATA*, *Schultes, Obs.* 20.—*A. glauca*, var. *spinosior*, *Haw. Revis.* 40. Folia minus glauca magis patula dorso apice parce tuberculato-aculeata, dentibus marginalibus majoribus igneo-rubris. *C. B. Spei*.

17. *A. HETERACANTHA*, *Baker*.—*A. inermis*, *Hort., via Forsk.* Caulis brevis simplex. Rosula foliorum 15–18 poll. diam. Folia densa lanceolata acuminata 9–12 poll. longa $1\frac{1}{2}$ –2 poll. lata viridia facie supra basin canaliculata parce irregulariter albo maculata medio 3–4 lin. crassa utrinque inermia juniora obscure viridi lineata seniora concoloria exteriora apice recurvata margine raro inermia sæpissime dentibus paucis parvis deltoideis albidis $\frac{1}{2}$ –1 lin. longis prædita. Flores ignoti. *Patria ignota*. V. v. in *Hort. Kew.* etc.

18. *A. PERRYI*, *Baker*. Habitus *A. heteracanthæ*. Caulis simplex 1 poll. diam. Folia rosulata lanceolata 7–8 poll. longa $2\frac{1}{2}$ poll. lata infra medium ad apicem angustata pallide glauco-viridia immaculata obscure verticaliter lineata supra basin canaliculata medio 3–4 lin. crassa, dentibus marginalibus crebris deltoideis 1 lin. longis apice corneis brunneis infimis exceptis ascendentibus. Inflorescentia sesquipedalis, pedunculo communi ancipiti vix pedali, ramis tribus, racemis densis 3–4 poll. longis, pedicellis 3–4 lin. longis, bracteis lanceolatis pedicellis subæquilongis. Perianthium irridulum 9–10 lin. longum, segmentis oblongis tubo triplo brevioribus. Genitalia inclusa. *Insula Socotra*, Wykeham Perry! Collin! Dr. I. B. Balfour!

19. *A. CHINENSIS*, *Baker in Bot. Mag.* t. 6301.—*A. barbadensis*, var. *chiuensis*, *Haw. Suppl.* 45; *Kunth, Enum.* iv. 522. Breviter caulescens, caule simplici. Folia 15–20 dense rosulata, in plantis junioribus sæpe subdisticha, ensiformia 9–12 poll. longa deorsum $1\frac{1}{4}$ –poll. lata pallide viridia haud lineata maculis paucis albidis parvis sæpe decorata basi subplana medio 3–4 lin. crassa supra basin canaliculata, aculeis marginalibus distantibus deltoideis pallidis 1 – $1\frac{1}{2}$ lin. longis. Pedunculus simplex pedalis vel semipedalis. Racemus laxus simplex 6–8-pollicaris, expansus 2 poll.

diam., pedicellis cernuis $1\frac{1}{2}$ –2 lin. longis, bracteis lanceolatis vel deltoideis 3–4 lin. longis. Perianthium luteum cylindricum 1 poll. longum, segmentis lanceolatis tubo triplo longioribus. Stamina perianthio æquilonga. Stylus demum breviter exsertus. *China*, anno 1817 in hortos europæos introducta.

20. *A. CRASSIPES*, Baker. Folia ensiformia pedalia et ultra e basi 7–8 lin. lata ad apicem acuminatum sensim attenuata distincte verticaliter viridi lineata, aculeis marginalibus patulis deltoideis, inferioribus $1\frac{1}{2}$ lin. longis, superioribus sensim minoribus. Scapus simplex validus sesquipedalis deorsum anceps. Racemus laxus semipedalis, expansus $2\frac{1}{2}$ –3 poll. diam., pedicellis ascendentibus, inferioribus 1 poll. longis, bracteis lanceolatis acutis 4–6 lin. longis. Perianthium cylindricum 15 lin. longum, supra ovarium leviter constrictum, tubo campanulato, segmentis elongatis. Genitalia inclusa. *Africa tropicalis centralis inter Suakin et Berber*, Schweinfurth 3765!

21. *A. ANGOLENSIS*, Baker in *Trans. Linn. Soc.* 2nd ser. *Bot.* i. 263. Subcaulis. Folia dense rosulata ensiformia acuminata $1\frac{1}{2}$ –2 poll. lata glauco-viridia immaculata falcata utrinque inermia, aculeis marginalibus marginalibus distantibus deltoideis corneis pallidis uncinatis $\frac{1}{2}$ –1 lin. longis. Pedunculus validus ramosus 2–3-pedalis. Racemi densi 3–4 poll. longi, expansi 2 poll. diam., pedicellis infimis 2–3 lin. longis, bracteis deltoideis 4–6 lin. longis. Perianthium sulphureum cylindricum 9–10 lin. longum, segmentis viridi vittatis tubo duplo longioribus. Genitalia inclusa. *Angola in ditione Barro do Benga*, Welwitsch 3728!

22. *A. LOMATOPHYLLOIDES*, Balf. fil. in *Journ. Linn. Soc.* xvi. 22; Baker, *Fl. Maurit.* 372. Subcaulis. Folia dense rosulata ensiformia acuminata $1\frac{1}{2}$ –2-pedalia deorsum $2\frac{1}{2}$ –3 poll. lata viridia immaculata dentibus marginalibus deltoideis patulis pallidis $\frac{1}{2}$ –1 lin. longis. Pedunculus semipedalis vel pedalis trifurcatus. Racemi densi 3–6 poll. longi, pedicellis inferioribus demum 6–12 lin. longis, bracteis minutis lanceolatis vel deltoideis. Perianthium rubellum 8–9 lin. longum, tubo campanulato, segmentis tubo duplo longioribus. Genitalia demum breviter protrusa. *Insula Rodriguez*, Dr. I. B. Balfour 1306!

23. *A. STRIATA*, Haw. in *Trans. Linn. Soc.* vii. 18 (1804); *Syn.* 81.—*A. paniculata*, Jacq. *Fragm.* 48, t. 68 (1809); *Roem. et Schult.* vii. 691; *Kunth, Enum.* iv. 522.—*A. albocincta*, Haw. *Suppl.* 43; *Kunth, Enum.* iv. 525.—*A. Hanburiana*, Naud. in *Rev. Hort.* 1875, 165.—Caulis æstate pedalis vel bipedalis 3–4 poll. diam. Folia 12–20 dense rosulata exteriora recurvata lanceolata sesquipedalia vel bipedalia 4–6 poll. lata glauca obscure maculata et lineata facie subplana medio 3–4 lin. crassa margine pallide cartilagineo albido vel rubro tincto integro crispato 1 lin. lato prædita ubique inermia. Scapus validus ramosissimus sesquipedalis vel bipedalis, racemis 20 vel ultra brevibus capitatis, expansis 2– $2\frac{1}{2}$ poll. diam., pe-

dicellis ascendentibus, inferioribus, 6-9 lin. longis, bracteis parvis lanceolatis vel deltoideis. Perianthium splendide rubrum 10-12 lin. longum, tubo clavato supra ovarium valde constrictum, segmentis tubo duplo brevioribus. Stamina perianthio æquilonga. Stylus demum exsertus. *C. B. Spei, in ditione orientali, MacOwan 1144! Cooper! Ante 1795 introducta. A. RHODOCINCTA, Hort., est forma margine cartilagineo pallide rubello.*

24. *A. SERRULATA, Haw. in Trans. Linn. Soc. vii. 18; Sims in Bot. Mag. tab. 1415; Schultes fl. Syst. vii. 697; Salm-Dyck, Aloe, sect. xx. fig. 1; Kunth, Enum. iv. 522.*—*A. perfoliata, var. serrulata, Soland. in Ait. Hort. Kew. i. 466.* Caulis simplex æstate 1-2-pedalis $1\frac{1}{2}$ -2 poll. diam. Folia 12-20 dense rosulata lanceolata 6-9 poll. longa deorsum $1\frac{1}{2}$ -2 $\frac{1}{4}$ poll. lata pallide viridia medio 3-4 lin. crassa facie infra apicem plana vel leviter concava obscure lineata maculis copiosis albidis parvis obscure seriatis prædita, margine continuo corneo aculeis minutis corneis deltoideis denticulato, exteriora recurvata. Pedunculus simplex subpedalis. Racemus subdensus semipedalis, pedicellis 6-9 lin. longis, bracteis lanceolatis acuminatis 3-4 lin. longis. Perianthium rubellum 15-18 lin. longum cylindricum, supra ovarium vix constrictum, segmentis oblongis tubo 3-4plo brevioribus. Stamina perianthio æquilonga. Stylus demum breviter exsertus. *C. B. Spei.*

Var. ? *A. PALLESCENS, Haw. Revis. 41.* Minor, lineis et maculis obscuris. Flores ignoti. *Patria ignota.*

25. *A. TENUIFOLIA, Lam. Ency. i. 8?—A. Kirkii, Baker, MSS.* Brevis- sime caulescens. Folia 10-12 dense rosulata lanceolata 12-15 poll. longa 2-2 $\frac{1}{2}$ poll. lata infra medium ad apicem sensim angustata pallide viridia nullo modo lineata maculis parvis oblongis copiosis confluentibus irregulariter seriatis prædita medio $1\frac{1}{2}$ -2 lin. crassa facie infra apicem plana margine et basi rubro-brunneo tincta, aculeis marginalibus crebris deltoideis inæqualibus rubro-brunneis $\frac{1}{2}$ lin. longis. Flores ignoti. *Africa tropicalis austro-orientalis in ditione Zanzibar, a. cl. Kirkio anno 1877 missa.*

26. *A. MACROCARPA, Todaro in Hort. Bot. Panorm. 36, t. 9.* Brevis- sime caulescens, caule simplici. Folia 12-20 dense rosulata ovato-lanceo- lata subpedalia deorsum 3-4 poll. lata apice canaliculata medio 3-4 lin. crassa facie læte viridia haud lineata maculis copiosis magnis oblongis albidis irregulariter seriatis prædita, aculeis marginalibus crebris deltoideis patulis $\frac{1}{2}$ lin. longis apice corneis rubro-brunneis. Pedunculus bipedalis trifurcatus. Racemi laxi, terminalis semipedalis, expansi 2 $\frac{1}{2}$ -3 poll. diam., pedicellis inferioribus 5-6 lin. longis, bracteis parvis lanceolatis acutis. Perianthium clavatum splendide rubrum 15-16 lin. longum, tubo supra ovarium valde constrictum, segmentis lanceolatis tubo brevioribus. Genitalia perianthio æquilonga. *Abyssinia. Schimper anno 1870 in hortos europæos introduxit.*

27. *A. ALBOCINCTA* × *GRANDIDENTATA*. Brevissime caulescens, caule simplici. Folia 10–15 dense rosulata subpedalia, deorsum 3–4 poll. lata infra medium ad apicem sensim angustata, facie infra apicem plana medio 3–4 lin. crassa primum glauco-viridia demum pallide viridia obscure lineata maculis copiosis albidis oblongis parvis obscure seriatis instructa ubique corneo marginata, dentibus creberrimis deltoideis $\frac{1}{2}$ lin. longis omnino corneis pallide rubro-brunneis. Flores ignoti. Hybrida hortensis in hort. Kew. a Lynchio facta anno circiter 1877.

28. *A. SAPONARIA*, *Haw. Syn.* 83; *Schultes fil. Syst.* vii. 699; *Kunth, Enum.* iv. 526.—*A. disticha*, *Miller, Dict.* edit. vi. No. 5 (nomen primum sed ineptum).—*A. maculosa*, *Lam. Ency.* i. 87, *ex parte*.—*A. umbellata*, var. minor, *DC. Plantes Grasses*, t. 98.—*A. umbellata*, *Salm-Dyck, Aloe*, sect. xxiii. fig. 1.—*A. perfoliata*, var. *saponaria*, *Soland. in Ait. Hort. Kew.* i. 467, excl. syn. *Dill.*—*A. picta*, var. minor, *Willd. Sp. Plant.* ii. 187.—*A. Saponaria*, var. minor, *Haw. in Trans. Soc. Linn.* vii. 17; *Sims in Bot. Mag.* tab. 1460.—*A. africana maculata spinosa major*, *Dill. Hort. Eth.* 17, tab. 14. fig. 15. Breviter caulescens, caule simplici $1\frac{1}{2}$ –2 poll. diam. Folia 12–20 dense rosulata lanceolata 9–12 poll. longa 18–24 lin. lata infra medium ad apicem angustata medio 3–4 lin. lata facie deorsum plana dorso turgida viridia maculis albidis copiosis oblongis irregulariter seriatis instructa sæpe plus minusve distincte lineata, aculeis marginalibus contiguis deltoideis cuspidatis corneis apice rubro-brunneis $1\frac{1}{2}$ –2 lin. longis. Scapus 1–2-pedalis simplex vel parce ramosus. Racemi densi corymbosi 3–4 poll. longi et lati, pedicellis inferioribus $1\frac{1}{2}$ –2 poll. longis, bracteis parvis lanceolatis acutis. Perianthium splendide rubro-luteum 18–21 lin. longum, supra ovarium constrictum, segmentis dorso viridulis tubo duplo brevioribus. Genitalia perianthio æquilonga. *C. B. Spei*, Drège 8635! etc. Var. *LUTEO-STRIATA*, *Haw.*, est forma foliis conspicue albidostriatis. Var. *BRACHYPHYLLA*, *Baker*, est forma nana subcaulis foliis 3–4 poll. longis, aculeis minoribus pedunculo simplici subpedali.

29. *A. LATIFOLIA*, *Haw. Syn.* 82; *Schultes fil. Syst.* vii. 700; *Kunth, Enum.* iv. 526; *Salm-Dyck, Aloe*, sect. xxiii. fig. 3.—*A. Saponaria*, var. *latifolia*, *Haw. in Trans. Linn. Soc.* vii. 18; *Sims in Bot. Mag.* tab. 1346. Breviter caulescens, caule æstate 1–2-pedali, $1\frac{1}{2}$ –2 poll. diam., semper simplici. Folia 12–20 dense rosulata ovato-lanceolata subpedalia deorsum $2\frac{1}{2}$ – $3\frac{1}{2}$ poll. lata infra medium ad apicem sensim angustata facie infra apicem plana medio 3–4 lin. crassa viridia haud lineata maculis magnis copiosis lineari-oblongis albidis irregulariter seriatis instructa, aculeis marginalibus deltoideis cuspidatis $1\frac{1}{2}$ –2 lin. longis apice corneis rubro-brunneis. Pedunculus bipedalis robustus sæpissime ramosus, ramis 3–4 erecto-patentibus. Racemi dense corymbosi, terminalis 4–5 poll. longus et latus, pedicellis inferioribus $1\frac{1}{2}$ –2 poll. longis, bracteis lanceolatis acuminatis 12–15 lin. longis. Perianthium splendide luteo-coccineum 15–18 lin. longum, supra ovarium leviter constrictum, segmentis dorso viridulis

tubo subduplo brevioribus. Genitalia perianthio æquilonga. *C. B. Spei in ditione orientali*, Bolus 751! etc. In hortos europæos anno 1795 introducta. A. LEPTOPHYLLA, *N. E. Brown, MSS.*, a typo præsertim recedit foliis tenuioribus.

30. A. OBSCURA, *Miller, Gard. Dict.* edit. vi. No. 7; *Haw. Syn.* 82; *Schultes fil. Syst.* vii. 700; *Kunth, Enum.* iv. 526.—A. perfoliata, var. obscura, *Soland. in Ait. Hort. Kew.* i. 467.—A. africana maculata spinosa minor, *Dill. Hort. Elth.* tab. 15. fig. 16.—A. maculosa, *Lam. Ency.* i. 87, *ex parte*.—A. picta, *Thunb. Diss.* No. 4, *ex parte*; *DC. Plantes Grasses*, t. 97; *Sims in Bot. Mag.* t. 1323; *Salm-Dyck, Aloe*, sect. xxiii. fig. 2. Caulis simplex æstate pedalis 1½–2 poll. diam. Folia 15–30 dense rosulata subpedalia deorsum 2–3 poll. lata facie infra apicem plana medio 3–4 lin. crassa viridia primum leviter glaucescentia obscure lineata maculis copiosis albidis parvis oblongis irregulariter seriatis instructa, aculeis marginalibus deltoideo-cuspidatis 1–1½ lin. longis apice corneis brunneis. Scapus validus 1½–2-pedalis simplex vel parce ramosus, basi anceps, superne bracteis vacuis multis deltoideis instructus. Racemus densus semipedalis vel interdum pedalis, expansus 4–5 poll. diam., pedicellis ascendentibus 12–21 lin. longis, bracteis deltoideis cuspidatis 4–6 lin. longis. Perianthium splendide coccineum 15–18 lin. longum, supra ovarium leviter constrictum, segmentis lanceolatis dorso viridibus tubo subduplo brevioribus. Stamina perianthio æquilonga. Stylus demum exsertus. *C. B. Spei.*

31. A. COMMUTATA, *Todaro, Hort. Bot. Panorm.* i. 75, t. 18. Acaulis. Folia 10–12 dense rosulata oblongo-lanceolata 10–12 poll. longa 2–3 poll. lata medio 3–4 lin. crassa, facie infra apicem plana viridia obscure lineata maculis copiosis albidis oblongis obscure seriatis prædita, aculeis marginalibus deltoideo-cuspidatis 1½–2 lin. longis apice corneis rubro-brunneis. Pedunculus 2–3-pedalis sursum ramosus; racemi 3–6 poll. longi, inferne laxi, expansi 2½–3 poll. diam., pedicellis ascendentibus 6–9 lin. longis, bracteis parvis lanceolatis acutis. Perianthium splendide rubrum 12–18 lin. longum supra ovarium distincte constrictum, segmentis tubo brevioribus. Genitalia perianthio æquilonga. *Abyssinia, alt. 6000 pedum*, Schimper 798, coll. 1863–68! (*Herb. Mus. Brit.*). In Hort. bot. Panorm. anno 1878 culta. Inter *latifoliam* et *grandidentatam* medium tenens. “Erreh” incolarum.

32. A. GREENII, *Baker*. Breviter caulescens, caule simplici 1½ poll. diam. Folia dense rosulata lanceolata 15–18 poll. longa deorsum 2½–3 poll. lata infra medium ad apicem sensim angustata medio 3–4 lin. crassa facie infra apicem plana nitide viridia obscure lineata maculis copiosis oblongis albidis irregulariter seriatis prædita, aculeis marginalibus crebris deltoideis cuspidatis 1½–2 lin. longis apice corneis rubro-brunneis. Inflorescentia bipedalis, ramis 5–7 ascendentibus. Racemi oblongi 4–8 poll. longi, expansi 3 poll. diam., pedicellis inferioribus 5–6 lin. longis, bracteis

lanceolatis acuminatis pedicello subæquilongis. Perianthium pallide rubrum 14-15 lin. longum, tubo supra basin globosam conspicue constricto, segmentis tubo 2-3plo brevioribus. Stamina longiora cum stylo breviter exserta. *C. B. Spei.* V. v. in hort. Kew., ubi anno 1879 floruit.

33. *A. GRANDIDENTATA*, *Salm-Dyck, Hort.* 329; *Aloe*, sect. xxiii. fig. 4; *Schultes fil. Syst. Veg.* vii. 699; *Kunth, Enum.* iv. 625. Breviter caulescens, caule semper simplici æstate pedali $2\frac{1}{2}$ -2 poll. diam. Folia 12-20 dense rosulata lanceolata 12-20 poll. longa deorsum $2\frac{1}{2}$ -3 poll. longa infra medium ad apicem sensim angustata facie infra tertiam superiorem plana, medio 3-4 lin. crassa viridia obscure lineata maculis copiosis oblongis albidis confluentibus irregulariter seriatis prædita, aculeis marginalibus crebris deltoideis cuspidatis 2 lin. longis apice corneis rubro-brunneis. Pedunculus robustus purpureus bipedalis, ramis 5-7 erecto-patentibus. Racemi laxi 6-8 poll. longi, expansi $2-2\frac{1}{2}$ poll. diam., pedicellis inferioribus 5-6 lin. longis, bracteis lanceolatis acutis pedicello subæquilongis. Perianthium clavatum 12-13 lin. longum pallide rubro-luteum supra ovarium distincte constrictum, segmentis tubo æquilongis dorso viridulis. Genitalia perianthio subæquilonga. *C. B. Spei.* In hortos europæos anno 1822 introducta.

34. *A. GASTERIOIDES*, *Baker.* Brevisse caulescens, caule simplici. Folia dense rosulata crassa lanceolata 4-5 poll. longa viridia insigniter lineata et maculis copiosis oblongis albidis irregulariter seriatis instructa, dentibus marginalibus parvis deltoideis. Scapus simplex subpedalis. Racemus laxus oblongus, pedicellis inferioribus 6-9 lin. longis, bracteis lanceolatis acutis pedicellis subduplo brevioribus. Perianthium 1 poll. longum splendide coccineum supra basin globosam valde constrictum, segmentis lanceolatis dorso viridulis tubo subduplo brevioribus. Genitalia inclusa. *C. B. Spei.* V. v. in Hort. Kew., ubi anno 1875 floruit.

35. *A. TRICOLOR*, *Baker in Bot. Mag.* t. 6324. Brevisse caulescens, caule semper simplici. Folia 12-16 dense rosulata lanceolata 5-6 poll. longa deorsum $1\frac{1}{2}$ -2 poll. lata infra medium ad apicem sensim angustata medio 5-6 lin. crassa dorso rotundata facie leviter turgida viridia maculis parvis oblongis copiosis irregulariter seriatis haud lineata, aculeis marginalibus patulis crebris deltoideo-cuspidatis $\frac{3}{4}$ -1 lin. longis sursum corneis rubro-brunneis instructa, exteriora valde recurvata. Scapus sesquipedalis glaucus purpureus. Panicula deltoidea, racemo terminali laxo oblongo 3-4 poll. longo 2 poll. lato, lateralibus 2-3 brevioribus pedunculatis, pedicellis ascendentibus 3-4 lin. longis, bracteis parvis lanceolatis pedicellis subæquilongis. Perianthium coccineum cylindricum subpollicare medio vix constrictum, segmentis oblongis tubo brevioribus. Genitalia perianthio æquilonga. *Patria ignota, verisimiliter C. B. Spei.*

36. *A. AGAVÆFOLIA*, *Todaro, Hort. Bot. Panorm.* i. 85, t. 23. Breviter caulescens, caule simplici. Folia 20 vel ultra dense rosulata lanceolata

sesquipedalia deorsum 4-4½ poll. lata tenuia macera per totam longitudinem canaliculata viridia obscure lineata maculis parvis oblongis albidis sparsis prædita, margine tenuissimo albocarneo, dentibus deltoideis 1-1½ lin. longis. Pedunculus tripedalis superne 5-furcatus; racemi oblongi subdensi 3-4 poll. longi, pedicellis 3-4 lin. longis, bracteis lanceolatis acutis pedicello subæquilongis. Perianthium rubrum 15 lin. longum, supra ovarium leviter constrictum, segmentis tubo æquilongis dorso viridibus. Genitalia demum leviter exserta. *Africa tropicalis?* In Hort. bot. Panorm. anno 1879 culta.

37. A. ZEBRINA, *Baker in Trans. Linn. Soc. 2nd ser. Bot. i. 264.* Breviter caulescens, caule simplici semipedali 1½-2 poll. diam. Folia dense rosulata lanceolata 6-12 poll. longa 1½-2 poll. lata acuminata crassa glaucescentia distincte lineata utrinque maculis albis seriatis prædita, aculeis marginalibus deltoideis patulis corneis brunneis 1½-2 lin. longis. Pedunculus tripedalis superne furcatus; racemi laxi, terminalis subpedalis, expansum 2-2½ poll. diam., pedicellis ascendentibus 3-6 lin. longis, bracteis lanceolatis acuminatis 3-4 lin. longis. Perianthium rubrum 12-15 lin. longum, tubo supra ovarium constricto, segmentis tubo 2-3plo brevioribus. Stamina perianthio æquilonga. Stylus demum interdum leviter exsertus. *Angola, Welwitsch!*

38. A. PLATYPHYLLA, *Baker in Trans. Linn. Soc. Bot. i. 264.* Caulis simplex semipedalis vel pedalis. Folia dense rosulata lanceolata sesquipedalia 2½-3 poll. lata glauco-viridia conspicue lineata maculis oblongis copiosis subseriatis picta, aculeis marginalibus deltoideis corneis brunneis patulis 1½ lin. longis. Pedunculus ramosus tripedalis, racemis elongatis sublaxi semipedalibus vel pedalibus, pedicellis ascendentibus 4-6 lin. longis, bracteis parvis lanceolatis. Perianthium rubrum 12-15 lin. longum, segmentis brevibus. Genitalia perianthio æquilonga. *Angola, in dumetis siccis ditionis Pungo Andongo, etc., Welwitsch!*

39. A. MACRACANTHA, *Baker.* Caulis simplex 2-3-pedalis 1½-2 poll. diam. Folia 15-20 dense rosulata lanceolata 15-20 poll. longa deorsum 3-4 poll. lata e medio ad apicem sensim angustata medio 4 lin. crassa facie infra apicem plana viridia obscure lineata maculis magnis oblongis albidis irregulariter seriatis prædita, aculeis marginalibus deltoideis cuspidatis 3-4 lin. longis apice corneis brunneis. Flores ignoti. *C. B. Spei, Cooper, anno circiter 1870 in hortos europæos introduxit.*

40. A. MICROSTIGMA, *Salm-Dyck, Aloe, sect. xxvi. fig. 4.—A. arabica, Salm-Dyck, Cat. 27; Schultes fil. Syst. vii. 693, excl. syn.* Caulis simplex 4-5-pedalis. Folia 20-30 dense rosulata ensiformia 6-12 poll. longa deorsum 1½ poll. lata e basi ad apicem acuminatum sensim angustata medio 3-4 lin. crassa facie infra apicem plana dorso turgida viridia maculis modice copiosis haud seriatis parvis albidis prædita nullo modo lineata, aculeis

marginalibus crebris patulis deltoideo-cuspidatis apice corneis brunneis inferioribus $1\frac{1}{2}$ lin. longis instructa. Pedunculus simplex semipedalis vel pedalis, bracteis multis vacuis lanceolatis fultus. Racemus densus 6-9-pollicaris, expansus 2 poll. diam., pedicellis ascendentibus apice cernuis 9-12 lin. longis, bracteis obovatis pedicellis subduplo brevioribus. Perianthium luteum cylindricum 7 lin. longum, segmentis lanceolatis dorso viridulis. Genitalia demum leviter exserta. *C. B. Spei*, Ecklon. In hortos nostros anno 1816 introducta.

41. *A. BARTERI*, *Baker*. "Tripedalis." Folia ensiformia bipedalia supra basin dilatata 18-20 lin. lata e basi ad apicem sensim angustata maculis copiosis parvis oblongis albidis haud seriatis instructa, aculeis marginalibus deltoideis patulis corneis $1\frac{1}{2}$ lin. longis interdum confluentibus. Racemi laxi 8-12 poll. longi, expansi 2-2 $\frac{1}{2}$ poll. diam., pedicellis ascendentibus 9-12 lin. longis, bracteis lanceolatis acutis 3-6 lin. longis. Perianthium rubro-luteum 12-13 lin. longum, segmentis lanceolatis luteis dorso viridulis tubo subduplo brevioribus. Stamina perianthio æquilonga. Stylus breviter exsertus. *Guinea borealis in arenosis ad Nupe*, Barter 1502!

42. *A. CONSTRICTA*, *Baker*. Folia ensiformia 7-8 poll. longa e basi 12-15 lin. lata ad apicem acuminatum sensim attenuata maculis magnis albidis lineari-oblongis haud seriatis decorata, aculeis marginalibus deltoideis patulis $1\frac{1}{2}$ -2 lin. longis apice brunneis corneis. Racemi laxi pedales et ultra subsecundi, pedicellis 3-4 lin. longis, bracteis parvis lanceolatis acuminatis pedicello brevioribus. Perianthium clavatum splendide rubrum 18 lin. longum, tubo supra ovarium globosum valde constrictum, segmentis tubo brevioribus. Genitalia perianthio æquilonga. Capsula oblonga 15-16 lin. longa. *Africa tropicalis austro-orientalis in ditone Senna*, Dr. Kirk! "Nyakwere" incolarum.

43. *A. CONSOBRINA*, *Salm-Dyck*, *Aloe*, sect. xviii. fig. 3. Caulis bipedalis simplex 1 poll. diam. Rosula foliorum 10-12 poll. diam., interdum bipedalis, foliis superioribus ascendentibus, centralibus patulis, inferioribus deflexis, internodiis rubellis interdum 6-12 lin. longis. Folia sublaxe disposita ensiformia 6-8 poll. longa 1 poll. diam. viridia maculis copiosis parvis albidis ubique decorata, facie supra basin canaliculata medio 3 lin. crassa, aculeis marginalibus minutis deltoideis rubro-brunneis. Scapus sesquipedalis gracilis ramosus. Racemus sublaxus oblongo-cylindricus 3-4-pollicaris expansus 2 poll. diam., pedicellis 3-4 lin. longis, bracteis parvis lanceolatis acutis. Perianthium rubro-luteum cylindricum 12-15 lin. longum, tubo brevi campanulato, segmentis lanceolatis. Genitalia perianthio æquilonga. *C. B. Spei*. V. v. in hort. Kew. In hortos europæos anno circiter 1845 introducta.

44. *A. SPICATA*, *Haw. Syn.* 76, teste *Cooper*, an *Linn. fl.*? Longe caulescens. Folia ensiformia laxè disposita pedalia et ultra $1\frac{1}{2}$ -2 poll.

lata 4-4½ lin. crassa obscure viridia leviter glauco tincta facie plana dorso rotundata prope basin obscure lineata maculis paucis parvis albidis oblongis apice et basi sæpe erosis decorata, aculeis marginalibus deltoideis corneis 1-1½ lin. longis superioribus patulis inferioribus deflexis. Flores mihi ignoti. *C. B. Spei.*

45. *A. CILIARIS*, *Haw. in Phil. Mag.* 1825, 281; *Schultes fil. Syst.* vii. 703; *Salm-Dyck, Aloe*, sect. xxv. fig. 1; *Kunth, Enum.* iv. 529. Caulis longe sarmentosus, ramis 3-4 lin. diam., internodiis 6-12 lin. longis obscure viridi striatis. Folia linearia patula late amplexicaulia viridia 4-6 poll. longa e basi 6-9 lin. lata ad apicem sensim angustata immaculata haud lineata medio 1 lin. crassa, dentibus marginalibus minutis albidis deltoideis basalibus majoribus ad oras vaginarum caulinarum in annulum persistentibus. Pedunculus gracilis simplex lateralis 3-9-pollicaris. Racemus simplex latus 2-4-pollicaris, pedicellis 3-4 lin. longis, bracteis minutis lanceolatis acutis. Perianthium cylindricum splendide rubrum 12-15 lin. longum, tubo elongato supra ovarium leviter constricto, segmentis brevibus oblongo-deltoideis apice viridibus. Genitalia demum leviter exserta. *C. B. Spei, in ditione orientali*, Burchell 3993! MacOwan 1146! Bolus 2689! In hortos europæos Bowie anno 1826 introduxit.

46. *A. TENUIOR*, *Haw. in Phil. Mag.* 1825, 281; *Roem. & Schultes, Syst.* vii. 704; *Salm-Dyck, Aloe*, sect. xxv. fig. 3; *Kunth, Enum.* iv. 529. Caulis longe sarmentosus, ramis floriferis 3-4 lin. diam., internodiis 6-12 lin. longis obscure viridi-striatis. Folia laxa linearia 5-8 poll. longa basi 5-8 lin. lata e medio ad apicem subobtusum sensim attenuata viridia immaculata leviter canaliculata medio 1 lin. crassa, aculeis marginalibus minutissimis pallidis deltoideis, basalibus reliquis vix majoribus. Pedunculus gracilis simplex 4-8-pollicaris. Racemus sublaxus simplex oblongo-cylindricus semipedalis, expansus 2 poll. diam., pedicellis 3-4 lin. longis, bracteis minutis lanceolatis acuminatis. Perianthium cylindricum pallide luteum 5-6 lin. longum, tubo cylindrico, segmentis brevibus oblongo-deltoideis apice dorso viridulis. Genitalia distincte exserta. *C. B. Spei, Drège* 3525; MacOwan 1140! in hortos europæos anno circiter 1820 a Bowie introducta.

47. *A. STRIATULA*, *Haw. in Phil. Mag.* 1825, 281; *Roem. et Schultes, Syst. Veg.* vii. 703; *Kunth, Enum.* iv. 529. Caulis longe sarmentosus, ramis floriferis 3-6 lin. diam., internodiis 6-12 lin. longis pallide conspicue viridi striatis. Folia linearia patula viridia 6-9 poll. longa, basi minus dilatata quam in *A. ciliari*, 6-8 lin. lata, supra basin ad apicem acuminatum attenuata leviter canaliculata medio 1 lin. crassa, aculeis marginalibus pallidis deltoideis ubique munita basalibus reliquis vix majoribus. Pedunculus simplex lateralis purpureus semipedalis. Racemus oblongus subdeusis simplex 3-6-pollicaris, expansus 2 poll. diam., pedicellis brevibus cernuis,

bracteis minutis. Perianthium luteum cylindricum 12-15 lin. longum, tubo cylindrico supra ovarium vix constricto, segmentis brevibus oblongo-lanceolatis dorso viridulis. Genitalia 3-4 lin. exserta. *C. B. Spei*, Burchell 3115! In hortos europæos anno 1823 a Bowie introducta.

48. *A. MACOWANI*, Baker. Caules cæspitosi sarmentosi 4-5-pedales, ramis floriferis crassitie digiti. Folia ad apicem ramorum subrosulata, inferiora laxè disposita patula, omnia lanceolata acuminata pedalia et ultra, deorsum 15-21 lin. lata saturate viridia immaculata, basi solum distincte lineata, aculeis marginalibus minutissimis deltoideis. Pedunculus simplex subpedalis deorsum anceps. Racemi densi semipedales et ultra, expansi 2 poll. diam., floribus valde deflexis, pedicellis brevissimis, bracteis minutis lanceolatis. Perianthium cylindricum 12-15 lin. longum, segmentis lanceolatis viridi vittatis tubo æquilongis. Stylus longe exsertus. In *syllis ad latera montis Boschberg, alt. 3500 pedum*, MacOwan 1915!

49. *A. GRACILIS*, Haw. in *Phil. Mag.* 1825, 280; *Roem. et Schultes, Syst. Veg.* vii. 706; *Kunth, Enum.* iv. 531. Habitus *A. frutescentis*, var. *laxifoliae*. Caulis foliiferus simplex 9-12 lin. diam., internodiis pallidis distincte viridi lineatis. Folia laxè disposita patula 6-10 poll. longa, basi 10-12 lin. lata, ensiformia acuminata glauca immaculata haud lineata facie leviter canaliculata medio 3-4 lin. crassa, dorso rotundata, aculeis marginalibus crebris minutis deltoideis patulis brunneo tinctis. Pedunculus simplex 6-9-pollicaris deorsum anceps. Racemus densus simplex 2-3-pollicaris, pedicellis 3-4 lin. longis, bracteis lanceolato-deltoideis acuminatis pedicello æquilongis. Perianthium luteum cylindricum 14-16 lin. longum, tubo brevi campanulato, segmentis elongatis lanceolatis. Stamina perianthio æquilonga. Stylus exsertus. *C. B. Spei, Simons Bay, C. Wright!* In hortos europæos anno 1823 a Bowie introducta, sed cito perditâ.

50. *A. ATHERSTONEI*, Baker. Plantam juniorem tantum vidi, habitu *A. frutescentis*, var. *laxifoliae*, caule simplici foliifero 1 poll. diam., foliis laxè dispositis summis exceptis patulis ensiformibus pedibus deorsum 12-15 lin. latis acuminatis nitide viridibus immaculatis striis longitudinalibus saturate viridibus ubique percursis planis medio $1\frac{1}{2}$ lin. crassis, aculeis marginalibus crebris pallidis deltoideo-cuspidatis $1-1\frac{1}{2}$ lin. longis. *C. B. Spei.* V. v. in Hort. Kew. anno 1878; Dr. Atherstone misit.

51. *A. NITENS*, Baker. Plantam juniorem vivam tantum vidi, habitu *A. frutescentis* var. *laxifoliae*, caule simplici foliifero 1 poll. crasso, internodiis rubro-purpureis obscure lineatis, foliis patulis laxè dispositis ensiformibus 12-15 poll. longis 18-21 lin. latis acuminatis nitide viridibus immaculatis haud lineatis medio 3-4 lin. crassis facie leviter canaliculatis dorso convexis, aculeis marginalibus crebris deltoideo-cuspidatis $1\frac{1}{2}$ lin.

longis brunneis corneis. *C. B. Spei*, v. v. in hort. Kew, anno 1878
Sir H. Barkly misit.

52. *A. DISTANS*, *Haw. Syn.* 78; *Roem. et Schultes, Syst.* vii. 714; *Kunth, Enum.* iv. 528; *Salm-Dyck, Aloe*, sect. xxiv. fig. 1.—*A. mitræformis*, var. *angustior*, *Lam. Encyc.* i. 87.—*A. mitræformis*, var. *brevifolia*, *Sims in Bot. Mag.* t. 1362.—*A. brevifolia*, *Haw. in Trans. Linn. Soc.* vii. 23, non *Syn.* 80. Caulis brevis simplex 1 poll. diam., internodiis pallidis distincte viridi striatis. Rosula foliorum 1–2 pedes longa, 5–6 poll. diam. Folia laxè disposita ovato-lanceolata 3–5 poll. longa $1\frac{1}{2}$ –2 poll. lata obscure viridia leviter glauco tincta immaculata haud lineata omnia ascendentia facie concava medio 3–4 lin. crassa dorso convexa parce tuberculato-aculeata, aculeis marginalibus crebris deltoideis albidis corneis 1– $1\frac{1}{2}$ lin. longis. Pedunculus sesquipedalis sæpissime simplex. Racemus densus capitatus 3–4 poll. diam., pedicellis inferioribus 12–15 lin. longis, bracteis parvis lanceolatis. Perianthium cylindricum pallide rubrum 15–18 lin. longum, tubo brevi, segmentis lanceolatis apice viridulis. Genitalia perianthio subæquilonga. *C. B. Spei*, ante annum 1735 in hortos europæos introducta.

53. *A. MITRIFORMIS*, *Miller, Gard. Dict.* edit. vi. No. 1; *Lam. Encyc.* i. 87; *DC. Plantes Grasses*, t. 99; *Sims in Bot. Mag.* t. 1270; *Haw. Syn.* 77.—*A. africana mitræformis spinosa*, *Dill. Hort. Elth.* 21, tab. 17. fig. 19.—*A. xanthacantha*, *Salm-Dyck, Aloe*, sect. xxiv. fig. 3. Caulis æstate 3–4 pedalis simplex 1–2 poll. diam., internodiis obscure viridi striatis. Rosula foliorum 10–12 poll. diam. Folia sublaxè disposita omnia ascendentia lanceolata semipedalia 2–3 poll. lata obscure viridia leviter glauco tincta immaculata haud lineata facie concava medio 3–4 lin. crassa dorso convexa parce aculeato-tuberculata, apice brevi corneo pungente, aculeis marginalibus modice crebris pallidis corneis patulis 1– $1\frac{1}{2}$ lin. longis. Pedunculus validus sesquipedalis sæpissime ramosus. Racemi densi corymbosi 4–6 poll. longi, expansi 4 poll. diam., pedicellis ascendentibus inferioribus 15–18 lin. longis, bracteis lanceolatis acutis pedicello 2–3plo brevioribus. Perianthium splendide rubrum cylindricum 18–21 lin. longum, tubo brevi campanulato, segmentis lanceolatis apice viridibus. Genitalia perianthio æquilonga. *C. B. Spei*.

Var. *A. COMMELYNI*, *Willd.*; *Salm-Dyck, Aloe*, sect. xxiv. fig. 5.—*A. mitræformis*, var. *humilior*, *Haw. in Trans. Linn. Soc.* vii. 23.—Minor, foliis ovato-lanceolatis 4–5 poll. longis ascendentibus magis glaucescentibus facie concavis dorso parce aculeato-tuberculatis, aculeis marginalibus albidis deltoideis. *C. B. Spei*.

Var. *A. SPINULOSA*, *Salm-Dyck, Obs.* (anno 1822), 4; *Aloe*, sect. xxiv. fig. 6; *Kunth, Enum.* iv. 526. A typo recedit foliis dorso copiose tuberculato-aculeatis, senioribus interdum apice recurvatis. *C. B. Spei*.

Var. *A. FLAVISPINA*, *Haw. in Trans. Linn. Soc.* vii. 22; *Syn.* 77; *Salm-Dyck, Aloe*, sect. xxiv. fig. 2; *Kunth, Enum.* iv. 527. A typo

recedit foliis angustioribus magis lanceolatis, aculeis flavo tinctis. *C. B. Spei.*

Var. *A. XANTHACANTHA*, Willd. in *Berl. Mag.* v. 282; *Haw. Suppl.* 48.—*A. mitræformis patula*, Hort.—*A. mitræformis*, *Salm-Dyck, Aloe*, sect. xxiv. fig. 4. A typo recedit foliis crassioribus (supra medium 5-6 lin.) magis patulis facie minus concavis, aculeis minoribus flavido tinctis. *C. B. Spei.*

Var. *PACHYPHYLLA*, Baker. Folia crassa patula semipedalia deorsum 21-24 lin. lata utrinque obscure purpurascens facie subplana dorso sub apicem aculeis 1-2 reductis sæpissime armata, aculeis marginalibus minutis folio concoloribus. *C. B. Spei*, Hort. Cooper, anno 1879.

54. *A. ALBISPINA*, *Haw. in Trans. Linn. Soc.* vii. 22; *Syn.* 78; *Roem. et Schultes, Syst.* vii. 712; *Kunth, Enum.* iv. 527. Caulis simplex brevis 1-1½ poll. diam. Rosula foliorum 12-15 poll. diam. Folia laxè disposita lanceolata ascendens 6-8 poll. longa 2 poll. lata viridia immaculata haud lineata facie superne concava medio 3-4 lin. crassa dorso convexa parce corneo-tuberculata, aculeis marginalibus albidis deltoideis corneis longe cuspidatis inferioribus 2 lin. longis. Pedunculus simplex sesquipedalis, bracteis multis vacuis magnis deltoideis superne præditus. Racemus densus semipedalis, expansus 4 poll. diam., pedicellis erecto-patentibus, inferioribus 15-18 lin. longis, bracteis deltoideis pedicello duplo brevioribus. Perianthium rubrum 1½ poll. longum, tubo 4 lin. longo, segmentis lanceolatis sursum viridibus. Genitalia perianthio æquilonga. *C. B. Spei.* In hortos europæos ante 1796 introducta. A formis omnibus *A. mitriformis* recedit aculeis crebrioribus majoribus.

55. *A. NOBILIS*, *Haw. Syn.* 71; *Schultes fil. Syst. Veg.* vii. 713; *Kunth, Enum.* iv. 528; *Salm-Dyck, Aloe*, sect. xxiv. fig. 7.—*A. mitræformis*, var. spinosior, *Haw. in Trans. Linn. Soc.* vii. 23. Caulis simplex æstate 3-4 pedalis 1½-2 poll. diam. Rosula foliorum 1-3 pedes longa, 1½-2 pedes diam. Folia sublaxè disposita lanceolata 9-12 poll. longa 2¼-4 poll. lata facie viridia immaculata haud lineata supra basin concava medio 3-4 lin. crassa, apice subpungente, dorso sursum aculeis paucis sparsis prædita, aculeis marginalibus modice crebris deltoideo-cuspidatis 1½-2 lin. longis apice corneis brunneis. Pedunculus simplex sesquipedalis. Racemus densus deltoideus semipedalis et ultra, expansus 4 poll. diam., pedicellis apice cernuis inferioribus 1½-2 poll. longis, bracteis lanceolatis 5-6 lin. longis. Perianthium rubrum 15-18 lin. longum, tubo brevi campanulato, segmentis ligulatis dorso viridibus. Genitalia 3-4 lin. exserta. *C. B. Spei.* In hortos nostros anno circiter 1800 introducta. Var. *DENSIFOLIA*, Baker, est forma magna foliis magis aggregatis.

56. *A. CÆSIA*, *Salm-Dyck, Cat.* 29; *Aloe*, sect. xvii. fig. 3; *Roem. et Schultes, Syst.* vii. 706; *Kunth, Enum.* iv. 531. Caulis simplex æstate (teste Cooper) 12-14-pedalis. Rosula foliorum 2 pedes longa et lata. Folia

subdensa lanceolata acuminata pedalia vel sesquipedalia deorsum 2-3 poll. lata intense glauca immaculata haud lineata deorsum plana superne leviter canaliculata medio 3-4 poll. crassa juniora rubro marginata, aculeis marginalibus deltoideis rubellis 1-1½ lin. longis. Scapus simplex subpedalis superne bracteis multia vacuis deltoideis præditus. Racemus densus semipedalis expansus 2½-3 poll. diam., pedicellis cernuis 12-15 lin. longis, bracteis deltoideis pedicello subduplo brevioribus. Perianthium rubrum 15-16 lin. longum, segmentis lanceolatis viridulis tubo æquilongis. Genitalia demum breviter exserta. *C. B. Spei ad montes Zuurberg, etc.*, Cooper. In hortos europæos anno circiter 1815 introducta.

57. *A. PALMIFORMIS*, *Baker in Trans. Linn. Soc.* 2nd ser. *Bot.* i. 263. Caulis 3-5-pedalis simplex vel ramosus. Folia dense rosulata lanceolata acuminata pedalia et ultra deorsum 1½-2 poll. lata glauco-viridia immaculata utrinque inermia, dentibus marginalibus crebris patulis deltoideis 1½-2 lin. longis et latis. Pedunculus simplex vel furcatus. Racemi sublaxi 6-8 poll. longi expansi 2½ poll. diam., pedicellis cernuis 4-6 lin. longis, bractea deltoideis pedicello triplo brevioribus. Perianthium cylindricum corallino-rubrum 10-12 lin. longum, segmentis tubo brevioribus. Stamina perianthio æquilonga. Stylus breviter exsertus. *Angola, in ditione Huilla, Welwitsch 3726!*

58. *A. ANDONGENSIS*, *Baker in Linn. Trans. Soc.* 2nd ser. *Bot.* i. 263. Caulis 1-2-pedalis 2-3ve partitus. Folia dense rosulata lanceolata acuminata 8-9 poll. longa deorsum 16-18 lin. lata immaculata glauco-viridia utrinque inermia, dentibus marginalibus crebris patulis deltoideis 1-1½ lin. longis apice brunneis corneis. Pedunculus brevis parce ramosus deorsum anceps. Racemi densi 2-3 poll. longi, expansi 2-2½ poll. diam., pedicellis patulis vel cernuis gracillimis 4-6 lin. longis, bracteis lanceolatis acuminatis pedicello subæquilongis. Perianthium cylindricum luteo-rubrum 8-9 lin. longum. Stamina perianthio æquilonga. Stylus demum breviter exsertus, *Angola, in ditione Pungo Andongo, Welwitsch 3729!*

59. *A. SUCCOTRINA*, *Lam. Encyc.* i. 85; *DC. Plantæ Grasseæ*, t. 85; *Haw. Syn.* 75; *Salm-Dyck, Aloe*, sect. xxii. fig. 1; *Kunth, Enum.* iv. 524. —*A. succotrina angustifolia spinosa* flore purpureo, *Commel. Hort. Med. Amstel.* i. 91, t. 48 (1697). —*A. perfoliata*, var. *succotrina*, *Curt. Bot. Mag.* t. 472. —*A. vera*, *Miller, Gard. Dict.* edit. vi. No. 15, non *Linn.* —*A. sinuata*, *Thunb. Diss.* No. 5, *ex parte*. Caulis 3-5-pedalis sæpe furcatus. Rosula foliorum 2½-3 pedes diam. Folia 30-40 dense rosulata ensiformia acuminata falcata sesquipedalia vel bipedalia basi 2 poll. medio 1 poll. lata obscure viridia leviter glauco tincta maculis paucis albidis interdum decorata utrinque inermia deorsum plana superne leviter canaliculata medio 3 lin. crassa anguste albido-corneo marginata, dentibus marginalibus deltoideis crebris pallidis 1 lin. longis. Pedunculus simplex sesquipedalis, bracteis paucis vacuis deltoideis instructus. Racemus densus semipedalis, expan-

sus 2½–3 poll. diam., pedicellis inferioribus 9–12 lin. longis, bracteis deltoideis pedicello duplo brevioribus. Perianthium rubellum cylindricum 15 lin. longum, tubo brevissimo, segmentis elongatis. Genitalia perianthio æquilongo. “*Insula Socotra*,” auct. vet. (locus mihi dubius). *C. B. Spei in collibus lapidosis dittonis Uitenhage*, Bolus 2688!

60. *A. PURPURASCENS*, *Haw. in Trans. Linn. Soc.* vii. 20; *Synops.* 75; *Salm-Dyck, Aloe*, sect. xxii. fig. 2; *Kunth, Enum.* iv. 524.—*A. sinuata*, *Thunb. Diss.* No. 5, *ex parte*.—*A. perfoliata*, var. *purpurascens*, *Soland. in Ait. Hort. Kew.* i. 466.—*A. soccotrina*, var. *purpurascens*, *Gawl. in Bot. Mag.* t. 1474.—*A. ramosa*, *Haw. in Trans. Linn. Soc.* vii. 44. Caulis 2–3-pedalis interdum furcatus. Folia 40–50 dense rosulata pedalia vel sesquipedalia ensiformia recta e basi 2 poll. lata ad apicem acuminatum sensim attenuata viridia leviter glauco tincta basi plana medio 3 lin. crassa superne leviter canaliculata utrinque inermia maculis parvis albidis interdum prædita, siccitate purpurea, dentibus marginalibus parvis albidis deltoideis. Scapus validus simplex sesquipedalis vel pedalis. Racemus densus 6–9-pollicaris, expansus 2½–3 poll. diam., pedicellis 9–12 lin. longis, bracteis oblongis dorso purpureis 6–9 lin. longis. Perianthium rubellum cylindricum 12–15 lin. longum, tubo brevissimo, segmentis elongatis. Genitalia perianthio æquilonga. *C. B. Spei*. In hortos nostros ante 1789 introducta. Ad *A. soccotrinam* arcte accedit.

61. *A. LITTORALIS*, *Baker in Trans. Linn. Soc.* 2nd ser. *Bot.* i. 263. Frutescens 6–10-pedalis, trunco sæpissime simplici crassitie brachii humani. Folia dense rosulata ensiformia acuminata 2–3-pedalia deorsum 2½–3 poll. lata immaculata haud lineata apice canaliculata, dentibus marginalibus deltoideis 1–1½ lin. longis apice brunneis corneis. Pedunculus ramosus 4–5-pedalis. Racemi subdensi pedales, expansi 2 poll. diam., pedicellis 3–4 lin. longis, bracteis membranaceis deltoideis pedicello duplo longioribus. Perianthium cylindricum 1 poll. longum, tubo supra ovarium haud constricto. Genitalia perianthio subæquilonga. *Loanda totius regio littoralis*, Welwitsch 3727!

62. *A. ABYSSINICA*, *Lam. Encyc.* i. 86 (excl. syn.); *Roem. et Schultes, Syst.* vii. 695; *Salm-Dyck, Aloe*, sect. xviii. fig. 1; *Kunth, Enum.* iv. 521; *A. Rich. Fl. Abyss.* ii. 324.—*A. vulgaris*, var. *abyssinica*, *DC. Plantes Grasses*, sub t. 27.—*A. maculata*, *Forsk. Fl. Ægypt.* 73? Caulis simplex 1–2-pedalis diam. 2–3 poll. Folia circiter 20 dense rosulata ensiformia 1½–2½-pedalia deorsum 3–4 poll. lata acuminata viridia sæpe irregulariter albo maculata haud lineata apice solum canaliculata medio 5–6 lin. crassa dorso rotundata, dentibus marginalibus distantibus deltoideis 1½–2 lin. longis apice brunneis corneis. Pedunculus ramosus sesquipedalis vel bipedalis. Racemi densi oblongi 3–4 poll. longi, expansi 2–3 poll. diam., pedicellis inferioribus 9–12 lin. longis, bracteis lanceolatis acuminatis 3–4 lin. longis. Perianthium luteum cylindricum 12–15 lin. longum, tubo brevi, segmentis elongatis dorso viridulis. Genitalia demum breviter exserta

Abyssinia, Schimper 927! (coll. 1863-68), Quartin Dillon & Petit 50!
Africa centralis tropicalis, Schweinfurth 206! 274! (forma floribus cinnabarinis) 275! *Unyoro*, Grant 50! In hortos europæos anno circiter 1777 a Cl. Bruce introducta.

Var. A. PEACOCKII, *Baker*. Folia 18-21 poll. longa basi 5-6 poll. lata glauco tincta immaculata. Perianthium luteum 12-13 lin. longum tubo cylindrico segmentis duplo brevior. *Abyssinia*, Hort. Peacock!

Var. A. PERCRASSA, *Todaro in Hort. Bot. Panorm.* i. 81, t. 21. Folia bipedalia basi 5-6 poll. lata glauco tincta immaculata. Racemi magis compacti, pedicellis infimis 5-6 lin. longis, bracteis pedicello subæquilongis. Perianthium cinnabarinum, tubo brevi, segmentis elongatis. *Abyssinia*, alt. 8000 *pedum*, Schimper. In hortos europæos anno 1873 introducta.

63. A. SCHWEINFURTHII, *Baker*. Folia ensiformia sesquipedalia e basi 2-2½ poll. lata ad apicem acuminatum sensim attenuata immaculata, dentibus crebris deltoideis patulis 1½-2 lin. longis. Scapus validus bipedalis ramosus deorsum anceps. Racemi angusti densi elongati, terminales demum 6-9 poll. longi, pedicellis inferioribus 4-6 lin. longis, bracteis lanceolatis 3-4 lin. longis. Perianthium pallide rubellum cylindricum 10-12 lin. longum, tubo brevi campanulato, segmentis ligulatis interioribus luteis. Stamina perianthio æquilonga. Stylus demum exsertus. *Africa tropicalis centralis in terra Niam-niam*, Schweinfurth, iii. 167!

64. A. ARBORESCENS, *Miller, Gard. Dict.* edit. vi. No. 3; *DC. Plantes Grasses*, t. 38; *Haw. Syn.* 76; *Sims in Bot. Mag.* t. 1306; *Andr. Bot. Rep.* t. 468; *Schultes fl. Syst.* vii. 708; *Salm-Dyck, Aloe*, sect. xxvi. fig. 3; *Kunth, Enum.* iv. 529.—A. perfoliata, var. arborescens, *Soland. in Ait. Hort. Kew.* i. 466.—A. fruticosa, *Lam. Ency.* i. 87.—A. arborea, *Medic. Bot.* 305.—*Catevala arborescens, Medic. Theod.* 67. Caulis simplex æstate 10-12-pedalis, 2-3 poll. diam. Rosula foliorum 3-4 pedes diam. Folia dense aggregata ensiformia 1½-2-pedalia deorsum 2 poll. lata e basi ad apicem acuminatum attenuata obscure viridia subglauca immaculata haud lineata medio 3-4 lin., basi 5-6 lin. crassa, facie supra basin canaliculata, aculeis marginalibus crebris deltoideis cuspidatis 1½-2 lin. longis, apice corneis pallidis basi viridibus, internodiis pallidis obscure viridi striatis. Pedunculales validus sesquipedalis simplex vel ramosus. Racemi densi semipedales vel pedales, pedicellis ascendentibus cernuis 12-15 lin. longis, bracteis obovato-cuneatis cuspidatis pedicello subduplo brevioribus. Perianthium rubrum rectum cylindricum 15-18 lin. longum, tubo brevissimo, segmentis lanceolatis dorso apice viridibus. Genitalia demum breviter exserta. *C. B. Spei*, ante annum 1700 in hortos europæos introducta.

Var. A. FRUTESCENS, *Salm-Dyck, Cat.* 30; *Haw. Suppl.* 46; *Kunth, Enum.* iv. 530. Humilior, copiose stolonifera, caulibus gracilioribus interdum ramosis, foliis sæpe laxioribus minoribus (10-15 poll. longis, deorsum 12-18 lin. latis) intense glaucis, internodiis distincte viridi lineatis, pedunculo simplici. *C. B. Spei*.

65. *A. PLURIDENS*, *Haw. in Phil. Mag.* 1824, 299; *Roem. et Schultes, Syst.* vii. 709; *Kunth, Enum.* iv. 530. Caulis ætate 10–12-pedalis simplex 4–6 poll. diam. Rosula foliorum 2–3 pedes diam. Folia densissime rosulata ensiformia acuminata $1\frac{1}{2}$ –2-pedalia deorsum $1\frac{1}{2}$ –2 poll. lata falcata nitida viridia immaculata subcoriacea medio 2–3 lin. crassa supra basin leviter canaliculata utrinque inermia, aculeis marginalibus crebris deltoideis ascendentibus pallidis 1– $1\frac{1}{2}$ lin. longis. Scapus simplex semipedalis vel pedalis superne bracteis pluribus vacuis deltoideis instructus. Racemus simplex densus semipedalis, expansus 4 poll. diam., pedicellis inferioribus 12–15 lin. longis, bracteis deltoideis 5–6 lin. longis. Perianthium rubro-aurantiacum cylindricum 12–15 lin. longum, tubo brevissimo, segmentis lanceolatis. Genitalia demum breviter exserta. *C. B. Spei, MacOwan* 1825! In hortos europæos anno circiter 1820 introducta.

66. *A. VERA*, *Linn. Sp. Plant.* edit. i. 320; *Webb, Can.* iii. 348.—*A. perfoliata* var. *vera*, *Linn. Sp. Plant.* edit. ii. 458.—*A. barbadensis*, *Miller, Gard. Dict.* edit. vi. No. 2; *Haw. in Trans. Linn. Soc.* vii. 19; *Kunth, Enum.* iv. 521.—*A. vulgaris* (*Bauhin*), *Lam. Encyc.* i. 86; *Sibth. & Sm. Fl. Græc.* t. 341; *Salm-Dyck, Aloe*, sect. xviii. fig. 2; *Bentl. & Trim. Med. Plants*, t. 282.—*A. vacillans*, *Forsk. Fl. Ægypt.* 74? Caulis brevis ætate 1–2-pedalis, 2–3 poll. diam., raro ramosus. Folia ensiformia dense aggregata $1\frac{1}{2}$ –2-pedalia deorsum 2–4 poll. lata e basi ad apicem sensim attenuata pallide viridia leviter glaucescentia medio 5–6 lin. crassa facie supra basin canaliculata in plantis junioribus parce irregulariter albo-maculata, aculeis marginalibus subdistantibus deltoideis corneis brunneis 1– $1\frac{1}{2}$ lin. longis. Scapus validus 2–3-pedalis simplex vel ramosus. Racemi densi semipedales vel pedales, expansi $1\frac{1}{2}$ –2 poll. diam., pedicellis cernuis $1\frac{1}{2}$ –2 lin. longis, bracteis lanceolatis acutis 3–4 lin. longis post anthesin reflexis. Perianthium luteum cylindricum 9–12 lin. longum, segmentis viridi vittatis tubo triplo longioribus. Stamina longiora cum stylo distincte exserta. *Regio mediterranea, nunc per regiones calidiores totius orbis disseminata.* In hortos anglicos anno 1596 ex insula Barbados adjecta, unde nomen Millerianum. *A. ELONGATA*, *Murray in Comm. Goett.* ix. 191, t. 2, est forma caudice graciliore magis elongato foliis angustioribus.

Var. *A. OFFICINALIS*, *Forsk. Fl. Ægypt.* 73.—*A. rubescens*, *DC. Plantas Grasses*, t. 15.—*A. indica*, *Royle, Him.* 390. Folia purpureo tincta. Flores splendide rubro-lutei. *Arabia, India orientalis, etc.*

Var. *A. LITTORALIS*, *Koenig*. Folia 15–18 poll. longa basi $1\frac{1}{2}$ poll. lata. Scapus simplex bipedalis. *Indiæ orientalis australis littora*, *Herb. Rottler!* Forma a typo ad *A. chinensem* accedens.

67. *A. DREPANOPHYLLA*, *Baker in Gard. Chron.* 1875, i. 814. Caudex simplex gracillimus ætate 10-pedalis. Rosula foliorum 3 pedes diam. Folia densa ensiformia falcata $1\frac{1}{2}$ –2-pedalia deorsum 2– $2\frac{1}{2}$ poll. lata e basi ad apicem acuminatum sensim angustata medio 3–4 lin. crassa facie glauca immaculata haud lineata supra basin leviter canaliculata, margine angusto

pallido, dentibus minutis deltoideis patulis apice corneis rubro-brunneis. Pedunculus brevis simplex. Racemus pedalis, expansus 3 poll. diam., pedicellis ascendentibus 5-6 lin. longis, bracteis parvis lanceolatis. Perianthium cylindricum 9-12 lin. longum primum rubro tinctum, demum albidum, tubo brevi campanulato, segmentis lanceolatis dorso viridibus. Genitalia 3-4 lin. exserta. *C. B. Spei*, in *ditione Somerset et ad montes Zuurberg*, Cooper in hortos europæos anno circiter 1860 introduxit!

68. A. SIGMOIDEA, *Baker*. Habitu *A. Salmdyckianæ*, caule gracillimo simplici 4-5-pedali, e basi interdum foliato. Folia densa lanceolata 15-18 poll. longa supra basin 3-4 poll. lata obscure viridia immaculata leviter glauco tincta medio 3 lin. crassa facie inermia apice solum leviter concava dorso parce aculeato-tuberculata juniora recurvata seniora basi patula medio ascendentia apice recurvata, aculeis marginalibus deltoideis 1-1½ lin. longis apice brunneis corneis. Flores ignoti. *Kaffraria borealis*, Hort. Cooper! anno 1879.

69. A. SALMDYCKIANA, *Schultes fl. Syst. Veg.* vii. 710; *Kunth, Enum.* iv. 530; *Salm-Dyck, Aloe*, sect. xxvii. fig. 1.—*Pachidendron Principis, Haw. Revis.* 37.—*A. africana, Salm-Dyck, Cat.* 31. Caudex simplex ætate 10-12-pedalis. Folia dense rosulata ensiformia 1½-2 pedes longa, 3 poll. lata, e basi ad apicem sensim angustata obscure viridia subglauca immaculata haud lineata supra basin leviter canaliculata medio 3-4 lin. crassa, aculeis marginalibus deltoideo-cuspidatis 1½-2 lin. longis apice corneis brunneis. Pedunculus simplex subpedalis. Racemus densus subpedalis expansus 3½-4 poll. diam., pedicellis cernuis 12-15 lin. longis, bracteis obovato-cuneatis rubro striatis pedicello duplo brevioribus. Perianthium subcylindricum rubrum rectum 15-18 lin. longum, tubo brevi campanulato, segmentis lanceolatis apice dorso viridulis. Genitalia 3-4 lin. exserta. *C. B. Spei*. In hortos europæos anno 1815 introducta.

70. A. CHLOROLEUCA, *Baker in Gard. Chron.* 1877, ii. 38. Caulis simplex in exemplis nostris 3-4-pedalis, diam. 3-4 poll. Rosula foliorum 3 pedes diam. Folia 50-60 dense disposita ensiformia haud falcata 1½-2 pedes longa, 21-24 poll. lata supra basin ad apicem acuminatum angustata saturate viridia immaculata haud lineata facie superne leviter canaliculata medio 3-4 lin. crassa utrinque inermia, aculeis marginalibus crebris deltoideis patulis apice corneis brunneis, inferioribus 1½ lin. longis. Pedunculus validus ramosus. Racemi densi subpedales expansi 3-4 poll. diam., pedicellis ascendentibus 3-4 lin. longis, bracteis deltoideis acutis 4-6 lin. longis. Perianthium albido-luteum cylindricum rectum 12-13 lin. longum, tubo brevi campanulato, segmentis lanceolatis dorso et apice viridibus. Genitalia 3-4 lin. exserta. *C. B. Spei*, v. v. in Hort. Kew. anno 1877.

71. A. PLATYLEPIS, *Baker in Gard. Chron.* 1877, ii. 38. Caulis sæpissime simplex, in hortis nostris interdum 10-pedalis. Rosula foliorum 3 pedes diam. Folia densa ensiformia 18-24 poll. longa deorsum 2-3

poll. lata infra medium ad apicem acuminatum angustata utrinque inermia obscure glauca viridia immaculata haud lineata supra basin canaliculata, medio 3-4 lin. crassa, aculeis marginalibus deltoideo-cuspidatis $1\frac{1}{2}$ -2 lin. longis apice corneis brunneis. Pedunculus validus sesquipedalis, ramis 3-6, racemus densus interdum pedalis, expansus 3-4 poll. diam., pedicellis ascendentibus 4-6 lin. longis, bracteis rotundato-deltoideis subacutis pedicellis subæquilongis. Perianthium cylindricum 12-13 lin. longum luteum vel pallide rubrum, tubo brevi campanulato, segmentis lanceolatis dorso viridibus. Genitalia 4-6 lin. exserta. *C. B. Spei*, v. v. in Hort. Kew. 1877, etc.

72. *A. SPECIOSA*, *Baker*. Arbor interdum 20-25-pedalis, habitu *A. africanæ* et *Salmdyckianæ*. Folia ensiformia nitide glauco-viridia, aculeis quam ii *A. africanæ* minoribus debilioribus. Pedunculus semipedalis validus. Racemus simplex densissimus pedalis, expansus 4 poll. diam., floribus inferioribus valde deflexis, pedicellis 2-3 lin. longis, bracteis rotundatis scariosis, inferioribus 6-8 lin. longis et latis. Perianthium cylindricum subrectum 12-14 lin. longum primum rubro tinctum cite albido-luteum, tubo subnullo, segmentis lanceolatis viridi vittatis. Genitalia rubra longe exserta. Stylus perianthio sesquilongior declinatus. *In præcipitibus prope Somerset East et haud procul a flumine Great Vischrievier*, MacOwan 1922!

73. *A. DICHOTOMA*, *Linn. fil. Suppl.* 206; *Thunb. Diss.* No. 1; *Flor. Cap.* 309; *Paters. Travels*, tab. 3, 4, 5; *Haw. Syn.* 75; *Kunth, Enum.* iv. 534; *Dr. J. C. Brown in Gard. Chron.* 1873, 712, fig. 137; *Dyer in Gard. Chron.* 1874, 567, figs. 118, 121.—*Rhipidodendron dichotomum*, *Willd. in Berl. Mag.* v. 106. Arborescens ramosissima 20-30-pedalis trunco brevi interdum 3-4 pedes diam., ramis ultimis lævibus apice 2 poll. diam., foliis mortuis ex ima basi delapsis. Folia ad apices ramorum dense rosulata lanceolata 8-12 poll. longa deorsum 12-15 lin. lata glauca immaculata haud lineata supra basin leviter canaliculata medio 3-4 lin. crassa, margine angustissime albido-corneo, dentibus crebris minutis pallidis patulis. Pedunculus brevis ramosus. Racemi laxi 2-4 poll. longi, expansi 2-2 $\frac{1}{2}$ poll. diam., rhachi valida sulcata, pedicellis erecto-patentibus 3-4 lin. longis apice articulatis, bracteis minutis lanceolatis acuminatis. Perianthium oblongum luteum 10-12 lin. longum, tubo campanulato, segmentis lanceolatis. Genitalia longe exserta. *Africa australis occidentalis in Namaqualand, etc.*, Baines! Sir H. Barkly! Rev. H. Whitehead!

74. *A. BAINESII*, *Dyer in Gard. Chron.* 1874, 568, figs. 119-120.—*A. Barberæ*, *Dyer, loc. cit.* fig. 122.—*A. Zeyheri*, *Hort.* Arborescens ramosissima 40-60-pedalis, trunco 4-5 ped. diam. Folia ad apices ramorum pauca dense rosulata coriacea ensiformia pedalia vel bipedalia (juniora 2-3-pedalia) 2-3 poll. diam. viridia immaculata profunde canaliculata recurvata medio 2-3 lin. crassa, aculeis marginalibus pallidis subdistantibus patulis

deltoideis 1-1½ lin. longis. Pedunculus brevis strictus validus 8-9 lin. diam. Racemus simplex brevis densus oblongus, rhachi crassissima, expansus 3½-4 poll. diam., pedicellis crassis 2-3 lin. longis apice articulatis, bracteis parvis linearibus squarrosis. Perianthium 15-16 lin. longum luteo-rubellum, tubo brevi campanulato, segmentis elongatis lanceolatis, exterioribus viridi vittatis. Genitalia longe exserta leviter declinata. *Natal et Caffraria*, Baines! etc. In hortos europæos anno circiter 1870 introducta.

75. *A. VARIEGATA*, Linn. *Sp.* 459; Miller, *Gard. Dict.* edit. vi. No. 9; *Thumb. Diss.* No. 12; *Bot. Mag.* t. 513; *DC. Plantes Grasses*, t. 21; *Haw. Syn.* 81; *Salm-Dyck, Aloe*, sect. xx. fig. 2; *Kunth, Enum.* iv. 523.—*A. punctata*, *Haw. in Trans. Linn. Soc.* vii. 26.—*A. africana humilis*, etc., *Commel. Prælucl.* t. 28. Acaulis. Rosula foliorum spiralter triquetra 6-8 poll. longa, 4-5 poll. diam. Folia densa erecto-patentia lanceolata 4-5 poll. longa 1 poll. lata facie concava dorso carinata utrinque viridia maculis copiosis oblongis confluentibus irregulariter seriatis decorata, margine albido denticulato. Scapus simplex teres 6-8-pollicaris, bracteis vacuis 2-3 lanceolatis præditus. Racemus simplex laxus 3-4 poll. longus, expansus 2½-3 poll. diam., pedicellis 3-4 lin. longis, bracteis albidis lanceolato-deltoideis pedicello subæquilongis. Perianthium rubellum cylindricum 15-16 lin. longum, tubo elongato, segmentis oblongis 3-4 lin. longis. Genitalia perianthio æquilonga. *C. B. Spei*.

76. *A. BOLUSII*, Baker. Plantam juniorem tantum vidi, caule subpedali, foliis laxè dispositis lanceolatis 6-8 poll. longis 1½-2 poll. latis infra medium ad apicem angustatis facie supra basin concava immaculata haud lineata leviter glauca haud muricata medio 3-4 lin. crasso, dorso copiose vel parce muricato, aculeis marginalibus quam ii *A. ferocis* majoribus deltoideis apice brunneis corneis, inferioribus 2 lin. longis et latis. *C. B. Spei in ditione orientali*, Bolus in Hort. Kew.! Hort. Cooper!

77. *A. FEROX*, Miller, *Dict.* edit. vi. No. 22; *Lam. Encyc.* i. 87; *DC. Plantes Grasses*, t. 32; *Haw. in Trans. Linn. Soc.* vii. 21; *Syn.* 76; *Sims in Bot. Mag.* t. 1975; *Salm-Dyck, Aloe*, sect. xxvii. fig. 5; *Gard. Chron.* 1875, fig. 44.—*A. perfoliata*, var. *ferox*, *Soland. in Ait. Hort. Kew.* i. 467.—*A. africana caulescens*, etc., *Commel. Prælucl.* 70, fig. 19.—*A. muricata & horrida*, *Haw. in Trans. Linn. Soc.* vii. 26.—*Pachidendron ferox*, *Haw. Revis.* 38. Caudex simplex æstate 10-15-pedalis diam. 4-6 poll., foliorum basibus delapsorum rugosus. Rosula foliorum 2-3 pedes longa et lata. Folia 30-50 dense aggregata lanceolata 1½-2 pedes longa 4-6 poll. lata, glauca obscure viridia facie supra basin concava medio 5-6 lin. crassa immaculata haud lineata utrinque spinis corneis multis sparsis muricata, apice subpungente, aculeis marginalibus crebris deltoideo-cuspidatis corneis brunneis inferioribus 2-2½ lin. longis. Pedunculus validus 2-pedalis prope basin ramosus. Racemi densissimi interdum pedales et ultra expansi 3-4 poll. diam., pedicellis brevissimis, bracteis 3 lin. longis acutis post anthesin

reflexis. Perianthium clavatum rubrum 15 lin. longum, tubo brevi campanulato. Genitalia longe exserta. *C. B. Spei*.

Var. SUBFEROX, *Spreng. Syst. Veg.* ii. 73.—*A. pseudo-ferox*, *Salm-dyck, Cat.* 31.—*Pachidendron pseudo-ferox*, *Haw. Revis.* 38. Folia facie vix muricata. *C. B. Spei*.

Var. ? INCURVATA, *Baker*. Folia subplana abrupte incurvata facie haud muricata. *Hort. Cooper!*, in statu juniore tantum cognita.

78. *A. AFRICANA*, *Miller, Gard. Dict.* edit. vi. No. 4; *Haw. in Trans. Linn. Soc.* vii. 21; *Syn.* 76; *Sims in Bot. Mag.* t. 2517; *Schultes fil. Syst.* vii. 709; *Salm-Dyck, Aloe*, sect. xxvii. fig. 2; *Kunth, Enum.* iv. 532.—*Pachidendron africanum*, *Haw. Revis.* 36. Caulis simplex æstate 20-pedalis. Folia dense rosulata ensiformia $1\frac{1}{2}$ –2-pedalia deorsum $2\frac{1}{2}$ –3 poll. lata e basi ad apicem sensim angustata obscure viridia primum glauco tinçta immaculata haud lineata supra medium canaliculata medio 4–5 lin. crassa, aculeis dorsalibus rarissimis, marginalibus crebris deltoideo-cuspidatis supra basin corneis brunneis inferioribus $1\frac{1}{2}$ –2 lin. longis. Scapus validus simplex subpedalis deorsum anceps. Racemus densus pedalis, expansus 3 poll. diam., pedicellis brevissimis, bracteis rotundato-deltoideis 3–4 lin. longis. Perianthium luteum valde recurvatum 15–18 lin. longum, segmentis dorso viridibus tubo cylindrico duplo longioribus. Genitalia longe exserta. *C. B. Spei*, etc.

79. *A. SUPRALÆVIS*, *Haw. in Trans. Linn. Soc.* vii. 22; *Syn.* 77; *Schultes fil. Syst.* vii. 711; *Salm-Dyck, Aloe*, sect. xxvii. fig. 6; *Kunth, Enum.* iv. 533.—*A. africana caulescens*, etc., *Commel. Præhud.* t. 20.—*Pachidendron supralæve*, *Haw. Revis.* 40. Caulis simplex æstate 5–6-pedalis 3–4 poll. diam. Folia dense rosulata ensiformia bipedalia $2\frac{1}{2}$ –3 poll. lata facie supra medium canaliculata medio 5–6 lin. crassa glauco-viridia immaculata haud lineata facie aculeis paucis medio prædita, dorso magis aculeata, apice subpungente, aculeis marginalibus crebris deltoideo-cuspidatis apice corneis brunneis inferioribus 2– $2\frac{1}{2}$ lin. longis, superioribus sensim minoribus. Pedunculus validus ramosus. Racemi densissimi interdum pedales, expansi 3 poll. diam., pedicellis cernuis 2–3 lin. longis, bracteis deltoideis acutis 2–4 lin. longis post anthesin reflexis. Perianthium clavatum 9–12 lin. longum luteum vel rubrum, tubo brevi campanulato. Genitalia longe exserta. *C. B. Spei*.

80. *A. THRASKII*, *Baker*. Caulis simplex, basi tuberosus, in exemplis nostris junioribus nunc $1\frac{1}{2}$ –2-pedalis, $1\frac{1}{2}$ –2 poll. diam. Rosula foliorum 3 pedes diam. Folia densa ensiformia bipedalia deorsum $2\frac{1}{2}$ –3 poll. lata falcata profunde canaliculata medio 3–4 lin. crassa modice glauca immaculata haud lineata, aculeis marginalibus deltoideo-cuspidatis $1\frac{1}{2}$ –2 lin. longis apice brunneis corneis. Scapus validus simplex pedalis et ultra. Racemus densissimus semipedalis, expansus 3– $3\frac{1}{2}$ poll. diam., pedicellis brevissimis, bracteis deltoideis acutis 3–4 lin. longis. Perianthium pollicare

clavatum leviter recurvatum luteum, tubo brevi campanulato, segmentis lanceolatis apice viridulis. Genitalia 6-7 lin. exserta. *C. B. Spei, in ditione Orange Free State, Cooper, in hortos europæos anno circ. 1860 introduxit!*

81. *A. PLICATILIS*, *Miller, Gard. Dict.* edit. vi. No. 7; *Curt. Bot. Mag.* t. 457; *DC. Plantes Grasses*, t. 73; *Jacq. Hort. Schæn.* t. 423; *Haw. Syn.* 74; *Salm-Dyck, Aloe*, sect. xxviii. fig. 1.—*A. disticha*, var. *plicatilis*, *Linn. Sp. Plant.* edit. i. 321.—*A. africana arborescens*, etc., *Commel. Hort. Amst.* ii. 5, t. 3.—*Kumara disticha*, *Medic. Theod.* 69, t. 4.—*A. tripetala*, *Medic. Bot. Beob.* 55.—*Rhipidodendron distichum*, *Willd. in Berl. Mag.* v. 165.—*R. plicatile*, *Haw. Revis.* 45. Caulis arborescens 10-pedalis et ultra ramosissima diametro pedali. Folia 10-30 ad apices ramorum densissima disticha ligulata 6-9 poll. longa 15-18 lin. lata intense glauca immaculata obtusa, margine angustissimo albedo superne denticulato. Scapus gracilis sæpissime simplex pedalis et ultra. Racemus semipedalis 20-30-florus, expansus 3-3½ poll. diam., pedicellis 6-9 lin. longis, bracteis parvis deltoideis acuminatis. Perianthium rubro-luteum cylindricum 18-21 lin. longum, segmentis interioribus subliberis exterioribus ad medium coalitis. Genitalia perianthio æquilonga. *C. B. Spei, in ditione Tulbagh, Worcester, etc.*

Var. *MAJOR*, *Salm-Dyck*. Robustior, foliis pedalis et ultra 2 poll. latis, ramis ul timis et pedunculis validioribus, floribus majoribus. *C. B. Spei.*

Species minus cognitæ.

82. *A. PENDENS*, *Forsk. Fl. Ægypt. Arab.* 74. "Folia subdisticha digito angustiora sesquispithamæa vel pedalia vaginantia remota. Flores racemosi flavi. Crescendo dependet sæpe e rupibus, pedunculis tamen surgentibus." *Ægyptus vel Arabia*, *Forskahl.*

83. *A. INERMIS*, *Forsk. Fl. Ægypt. Arab.* 74. "Folia carnosia 1½ poll. lata curva subtus convexa viridia, supra concava ferruginescentia albidomaculata prorsus inermia; lineæ duæ longitudinales elevatæ in pagina superiori foliorum. Margo folii hyalinus crassus cartilagineus." *Arabia felix ad urbem Taes*, *Forskahl.*

84. *A. ARABICA*, *Lam. Encyc.* i. 91.—*A. variegata*, *Forsk. Fl. Ægypt. Arab.* 74, non *Linn.* "Folia lineari-lanceolata margine retrorsum spinosodentata maculis albis sparsis, basi vaginantia; interdum conferta digitum longa, interdum angustiora pedalia remota minus maculata. Caulis basi nudus." *Ægyptus inferior et Arabia felix*, *Forskahl.*

85. *A. CLAVIFLORA*, *Burch. Travels*, i. 272. "Acaulis. Folia elongata glauca marginibus aculeatis. Flores dense spicati. Spica simplex. Corolla clavata, laciniis conniventibus." *C. B. Spei, in ditione Roggeveld*, *Burchell.*

86. *A. FALCATA*, *Baker*. Habitus mihi ignotus. Folia lanceolata valde

falcata 8-12 poll. longa supra basin dilatam 15-18 lin. lata crassa immaculata haud lineata apice pungente dorso sub apicem tuberculato-aculeata, margine aculeis copiosis corneis deltoideis rubro-brunneis $1\frac{1}{2}$ -2 lin. longis armata. Inflorescentia 15-18-pollicaris, pedunculo valido, ramis ascendentibus elongatis 4-7. Racemi subdensi 4-8 poll. longi, expansi 2-2 $\frac{1}{2}$ poll. diam., pedicellis ascendentibus 4-6 lin. longis, bracteis lanceolato-cuspidatis scariosis pedicello longioribus. Perianthium cylindricum 12-13 lin. longum, tubo elongato, segmentis lanceolatis viridi vittatis tubo æquilongis. Stamina perianthio æquilonga. Stylus breviter exsertus. *C. B. Spei*, Zeyher 1678 !

Species exclusa.

Aloe africana caulescens perfoliata glauca non spinosa, Commel. Prælud. 74, fig. 23, a Kunth sub *A. paniculata* citata, est *Crassulæ* species.

2. GASTERIA, Duval.

Pl. Succ. Hort. Alanc. 6; *Haworth, Syn.* 85; *Suppl.* 48.—*Aloe*, *Linn. Gen.* No. 430 *ex parte*; *Salm-Dyck, Monog. Aloe*, sect. xxix.; *Kunth, Enum.* iv. 492, *ex parte*.

Perianthium rubro-viride, tubo gamophyllo curvato deorsum oblongo basi cuneato sursum cite constricto cylindrico, segmentis 6 viridibus æqualibus diu imbricatis flore expanso apice solum regulariter falcatis. *Stamina* 6 hypogyna declinata perianthio paulo breviora, filamentis filiformibus, antheris lineari-oblongis versatilibus. *Ovarium* sessile oblongum triloculare, ovulis in loculo crebris; *stylus* filiformis leviter declinatus ovario subæquilongus, stigmatibus capitato trilobato. *Capsula* oblongo-triquetra chartacea loculicido-trivalvis apice umbilicata, seminibus obliquis crebris discoideis alatis, testa brunnea membranacea, albumine carnoso, embryone axili. *Herbæ humiles suffruticosæ, rosulis foliorum raro pedunculatis, foliis crassis carnis sæpissime lingulatis vel ensiformibus maculis albidis emersis vel immersis decoratis distichis vel subdistichis vel multifariis, pedunculo nudo, floribus racemosis sæpe paniculatis, pedicellis rubris, bracteis parvis persistentibus.*

Folia regulariter disticha.

Stirps *Verrucosæ*. Caulis foliiferus brevis. Folia facie tuberculis margaritaceis emersis rugosa

1. *G. verrucosa.* 2. *G. subverrucosa.* 3. *G. repens.*

Stirps *Linguae*. Caulis foliiferus brevis. Folia lingulata maculis copiosis immersis decorata.

Folia stricta lævissima nitida 4. *G. nigricans.*

Folia recurvata obscure viridia.

5. *G. brevifolia*. 6. *G. obtusifolia*. 7. *G. disticha*.
8. *G. sulcata*. 9. *G. mollis*.

Stirps *Bicolores*. Caulis foliiferus elongatus. Folia stricta lævia immaculata vel parce maculata.

Species sola 10. *G. bicolor*.

Stirps *Planifoliæ*. Caulis foliiferus elongatus. Folia lævia maculis copiosis immersis confluentibus.

Species sola 11. *G. planifolia*.

Folia spiraliter disticha.

Stirps *Sublinguæ*. Caulis foliiferus brevis. Folia conferta.

Maculæ minores vix confluentes.

12. *G. excavata*. 13. *G. spiralis*. 14. *G. dicta*.
15. *G. relata*. 16. *G. cheilophylla*.

Maculæ majores confluentes.

17. *G. pallescens*. 18. *G. porphyrophylla*. 19. *G. variolosa*.

Stirps *Maculatæ*. Caulis foliiferus elongatus. Folia laxa.

Maculæ paucæ parvæ obscuræ 20. *G. Zeyheri*

Maculæ minores minus confluentes.

21. *G. colubrina*. 22. *G. picta*.

Maculæ majores valde confluentes.

23. *G. pulchra*. 24. *G. maculata*.

Folia rosulata multifaria (in plantæ formis juvenilibus sæpe disticha vel spiraliter disticha).

Stirps *Carinatæ*. Perianthium normale generis 9–12 lin. longum. Folia tuberculis emersis rugosa.

Folia deltoidea tuberculis viridulis confertis.

25. *G. decipiens*.

Folia lanceolata tuberculis margaritaceis sparsis.

26. *G. carinata*. 27. *G. subcarinata*. 28. *G. pethamensis*.

Stirps *Nitidæ*. Perianthium normale generis 9–12 lin. longum.

Folia lævia, maculis parvis immersis albidis.

Folia lanceolato-deltoidea 2–4 poll. longa.

29. *G. parvifolia*. 30. *G. gracilis*.

Folia lanceolata semipedalia vel pedalia.

31. *G. latepuncta*. 32. *G. obtusa*. 33. *G. glabra*.

Folia lorata vel ensiformia 6–9 poll. longa.

34. *G. trigona*. 35. *G. marmorata*.

Folia lanceolata semipedalia vel pedalia.

36. *G. nitida*. 37. *G. fusco-punctata*.

38. *G. excelsa*. 39. *G. Peacockii*.

Stirps *Grandifloræ*. Perianthium normale generis 18–24 lin. longum. Folia lævia maculis parvis immersis albidis.

Folia stricta ensiformia 40. *G. acinacifolia*.

Folia minus stricta lanceolata.

41. *G. candicans*.

42. *G. Croucheri*.

Stirps *Apicroidæ*. Perianthium breve parvum, tubo subrecto, segmentis apice patulis. (Omnes inter *Gasterias* proprias et *Apicas* verisimiliter hybridæ hortenses.)

Caulis foliiferus brevis. Folia densa ... 43. *G. Bayfieldii*.

Caulis foliiferus elongatus. Folia laxa.

44. *G. apicroides*.

45. *G. squarrosa*.

1. *G. VERRUCOSA*, *Haw. Syn.* 89.—*Aloe verrucosa*, *Miller, Gard. Dict.* edit. vi. No. 20; *Willd. Sp.* ii. 189; *Bot. Mag.* t. 837; *Salm-Dyck, Aloe*, sect. xxix. fig. 25; *Kunth, Enum.* iv. 543.—*A. carinata*, *DC. Plantes Grasses*, t. 63.—*A. disticha*, *Thunb. Diss.* No. 9.—*A. disticha* β , *Linn. Sp.* 459. Caulis foliiferus 1–2-pollicaris. Folia 10–12 disticha conferta ensiformia exteriora patentia interiora solum ascendunt 6–9 poll. longa 1–1½ poll. lata medio 3 lin. crassa obscure viridia facie concava apice subpungente dorso turgida ubique tuberculis creberrimis margaritaceis parvis emersis haud seriatis rugosa præter apicem haud marginata. Pedunculus semipedalis. Racemi 4–8 in paniculam deltoideam dispositi; terminalis subpedalis, pedicellis 6–9 lin. longis, bracteis lanceolatis duplo brevioribus quam pedicelli. Perianthium 1 poll. longum, tubo deorsum oblongo 3 lin. crasso. *C. B. Spei*, ante annum 1730 culta. Var. *LATIFOLIA*, *Haw. Revis.* 47, est forma foliis pedibus 18–21 lin. latis.

Var. *G. INTERMEDIA*, *Haw. Syn.* 89.—*Aloe intermedia*, *Haw. in Trans. Linn. Soc.* vii. 12! *Salm-Dyck, Aloe*, sect. xxix. fig. 24; *Kunth, Enum.* iv. 542.—*A. Lingua*, *Ker in Bot. Mag.* t. 1322, *excl. syn.* Minor, foliis 12–14 lin. latis maculis margaritaceis emersis creberrimis rugosis, pedunculo simplici, perianthii tubo graciliore 2–2½ lin. diam.

Var. *SCABERRIMA*.—*Aloe scaberrima*, *Salm-Dyck, Hort.* 332; *Monog.* sect. xxix. fig. 26; *Kunth, Enum.* iv. 543.—*Gasteria intermedia*, var. *asperima*, *Haw. in Phil. Mag.* 1827, 355. Folia 6–9 poll. longa tuberculis validioribus albidis vel viridulis prædita. Pedunculus simplex.

2. *G. SUBVERRUCOSA*, *Haw. in Phil. Mag.* 1827, 354.—*Aloe subverrucosa*, *Salm-Dyck, Obs.* 67; *Roem. et Schultes, Syst.* vii. 671; *Kunth, Enum.* iv. 544. Caulis foliiferus 1½–2-pollicaris. Folia 8–10 disticha conferta lingulata semipedalia 1 poll. lata medio 3 lin. crassa apice rotundata cuspidata præter apicem tuberculato-marginata ubique maculis crebris parvulis haud seriatis albidis leviter emersis scabra. Pedunculus simplex pedalis. Racemus subpedalis simplex, pedicellis 3–4 lin. longis, bracteis lanceolatis pedicello brevioribus. Perianthium 10–11 lin. longum, tubo oblongo 2½–3

lin. crasso. *C. B. Spei*. Inter *verrucosam* et *disticham* medium tenens. Var. *PARVIPUNCTATA*, *Haw. loc. cit.*, est forma foliis longioribus ad apicem magis angustatis maculis minoribus sursum paucioribus prope foliorum basin crebrioribus confluentibus. Var. *MARGINATA*, *Baker* (*Algoa Bay*, *Cooper!*), est forma foliis brevibus apicis margine albedo corneo longe decurrente.

3. *G. REPENS*, *Haw. Revis.* 48.—*Aloe repens*, *Roem. et Schultes, Syst.* vii. 674; *Kunth, Enum.* iv. 542. Caulis foliiferus pollicaris. Folia 8–10 patentia conferta disticha lingulata $2\frac{1}{2}$ –3 poll. longa 9–10 lin. lata $1-1\frac{1}{2}$ lin. crassa apice rotundato-vel deltoideo-cuspidata apicis margine corneo albedo subdecurrente utrinque maculis parvis margaritaceis emersis interdum transversaliter seriatis decorata. Flores ignoti. Ex icone inedita *Kewensi* anno 1821 facta descripta. Verisimiliter hybrida hortensis.

4. *G. NIGRICANS*, *Haw. Syn.* 86.—*Aloe nigricans*, *Haw. in Trans. Linn. Soc.* vii. 13; *Salm-Dyck, Monog.* sect. xxix. fig. 7; *Kunth, Enum.* iv. 534.—*Aloe obliqua*, *Jacq. Hort. Schoen.* tab. 418, *excl. syn.*—*A. Lingua*, var. *crassifolia*, *Soland. in Ait. Hort. Kew.* i. 469; *Ker in Bot. Mag.* t. 838. Caulis foliiferus 2–3-pollicaris. Folia 12–20 disticha dense conferta lingulata coriacea stricta 4–8 poll. longa $1\frac{1}{2}$ –2 poll. lata deorsum 5–6 lin. medio 3–4 lin. crassa apice obtusa cuspidata facie deorsum turgida superne plana dorso rotundata margine præter apicem corneum albidum vix tuberculata, basi dilatata rubella cornea, faciebus ubique lævibus atro-vel purpureo-*viridibus* maculis copiosis parvis albidis immersis vix seriatis decoratis. Pedunculus validus pedalis et ultra sæpissime simplex. Racemus pedalis vel sesquipedalis, pedicellis inferioribus 3–4 lin. longis, bracteis lanceolatis pedicello æquilongis. Perianthium 9–10 lin. longum, tubo deorsum oblongo 3 lin. crasso. *C. B. Spei*, circiter annum 1730 introducta. *Algoa Bay*, *Cooper!* *G. CRASSIFOLIA* *Haw. in Phil. Mag.* 1827, 350, est forma foliis crassioribus 3–4 poll. longis 1 poll. latis margine infra apicem obscure tuberculatis. Var. *MARMORATA*, *Salm-Dyck, Obs.* 64, est forma maculis majoribus albidis et roseis marmoratim confluentibus.

Var. *G. FASCIATA*, *Haw. in Phil. Mag.* 1827, 349.—*Aloe nigricans*, var. *fasciata*, *Salm-Dyck, Obs.* 64.—*A. vittata*, *Roem. et Schultes, Syst.* vii. 662. Caulis foliiferus 4–5-pollicaris. Folia lorata 6–8 poll. longa 18–21 lin. lata lævissima margine superne lævia, faciebus ubique maculis copiosis albidis immersis confluentibus decoratis. Pedicelli inferiores 5–6 lin. longi.

Var. *POLYSPILA*, *Baker*. Caulis foliiferus 3-pollicaris. Folia 10–12 semipedalia 12–15 lin. lata margine infra apicem haud tuberculata maculis minoribus crebrioribus magis viridulis. *Algoa Bay*, *Cooper!*

Var. *A. GUTTATA*, *Salm-Dyck, Hort.* 332; *Monog.* sect. xxix. fig. 9; *Kunth, Enum.* iv. 547.—*Gasteria subnigricans*, var. *glabrior*, *Haw. in Phil. Mag.* 1827, 351. Caulis foliiferus 2–3-pollicaris. Folia 6–8 poll. longa

1½ poll. lata lorato-lingulata, maculis quam in typo minoribus, marginibus præter apicem corneum albidotuberculatis.

Var. *G. SUBNIGRICANS*, *Haw. in Phil. Mag.* 1827, 353.—*Aloe subnigricans*, *Spreng. Syst.* ii. 71; *Salm-Dyck, Aloe*, sect. xxix. fig. 10; *Kunth, Enum.* iv. 547. Caulis foliiferus 2-pollicaris. Folia lingulata semipedalia vel ultra 1½ poll. lata basi 5–6 lin. crassa, faciebus minus lævibus quam in typo, marginibus infra apicem scabris albo tuberculatis. A typo ad *G. disticham* accedens.

Var. *G. PLATYPHYLLA*, *Baker*.—*G. latifolia*, *Hort. Kew. via Haw. Syn.* 87. Caulis foliiferus 2–3-pollicaris. Folia lingulata 6–10 poll. longa 2–2½ poll. lata lævia rigide erecto-patentia, maculis copiosis parvis immersis, marginibus infra apicem integrum rugoso-tuberculatis. Inflorescentia bipedalis ramosa, racemo terminali sesquipedali. Forma major *G. subnigricantis*.

5. *G. BREVIFOLIA*, *Haw. Syn.* 89; *Phil. Mag.* 1827, 350.—*Aloe brachyphylla*, *Salm-Dyck, Hort.* 332; *Monog.* sect. xxix. fig. 8; *Kunth*, iv. 535. Caulis foliiferus 1–1½-pollicaris. Folia 10–12 dense conferta lingulata 3–4 poll. longa deorsum 21–24 lin. lata. deorsum 4–5 lin. crassa minus rigida et lævia quam in *G. nigricante*, apice obtuso cuspidato, marginibus infra apicem tuberculato-rugosis, faciebus sordide viridibus ubique maculis parvis albidis immersis decoratis, basi dilatata rubello-cornea. Pedunculus pedalis simplex vel furcatus. Racemus pedalis, pedicellis inferioribus 3–4 lin. longis, bracteis lanceolatis pedicello æquilongis. Perianthium 10–11 lin. longum, tubo deorsum oblongo 3 lin. diam. *C. B. Spei*, ante annum 1809 introducta. Inter *G. nigricantem* et *obtusifoliam* medium tenens.

6. *G. OBTUSIFOLIA*, *Haw. in Phil. Mag.* 1827, 350.—*Aloe obtusifolia*, *Salm-Dyck, Obs.* 62; *Monog.* sect. xxix. fig. 37; *Kunth, Enum.* iv. 548.—*A. Lingua*, var. *brevifolia*, *Salm-Dyck, Cat.* 17. Caulis foliiferus 1½–2 pollicaris. Folia 12–14 disticha dense conferta lingulata 4–6 poll. longa 2–2½ poll. lata basi 3 lin. medio 2 lin. crassa minus rigida quam in *G. nigricante* apice rotundata cuspidata margine infra apicem tuberculato-rugosa, faciebus obscure viridibus ubique maculis parvis albidis immersis haud seriatis decoratis, basi dilatata rubello-cornea. Pedunculus simplex pedalis et ultra. Racemus densus pedalis vel sesquipedalis, pedicellis inferioribus 5–6 lin. longis, bracteis lanceolatis pedicello subduplo brevioribus. Perianthium 10–12 lin. longum, tubo deorsum oblongo 3–4 lin. crasso. *C. B. Spei*, circiter annum 1815 introducta. Ad *G. disticham* arcte accedens; præsertim recedit foliis latis brevibus.

7. *G. DISTICHA*, *Haw. in Phil. Mag.* 1827, 351.—*G. denticulata*, *Haw. Suppl.* 50.—*Aloe disticha a*, *Linn. Sp.* 459; *Roem. et Schultes, Syst.* vii. 666; *Kunth, Enum.* iv. 546.—*A. Lingua*, *Thunb. Diss.* No. 14, *ex parte*; *Salm-Dyck, Aloe*, sect. xxix. fig. 33.—*A. linguiformis*, *Miller, Dict.* edit. vi.

No. 13, *ex parte*; DC. in *Red. Plantæ Grasses*, tab. 68. Caulis foliiferus 1-1½-pollicaris. Folia 10-12 disticha dense conferta patentia lingulata 4-6 poll. longa 1½ poll. lata basi 3 lin. medio 2 lin. crassa facie plana utrinque obscure viridia maculis parvis albidis immersis haud seriatis decorata marginibus conspicue rugoso-tuberculata, basi dilatata anguste albido-corneis. Pedunculus pedalis et ultra simplex vel ramosus. Racemus pedalis et ultra, pedicellis inferioribus 4-6 lin. longis, bracteis parvis lanceolatis. Perianthium 9-10 lin. longum, tubo deorsum 3 lin. crasso. *C. B. Spei*, in hortis e temporibus remotis culta.

Var. MINOR, *Baker*, est forma debilis, foliis 6-8 2-3 poll. longis 1 poll. latis, pedunculo simplici semipedali, racemo paucifloro.

Var. G. CONSPURCATA, *Haw. in Phil. Mag.* 1827, 352.—*Aloe conspurcata*, *Salm-Dyck, Obs.* 59; *Monog. sect. xxix. fig. 31*; *Kunth, Enum. iv. 546*, a typo recedit foliis longioribus interdum pedibus maculis minoribus crebrioribus decoratis, tuberculis marginalibus minus conspicuis, floribus paulo majoribus.

Var. G. ANGUSTIFOLIA, *Haw. Syn.* 88.—*Aloe angustifolia*, *Salm-Dyck, Obs.* 57; *Monog. sect. xxix. fig. 30*.—*A. Lingua*, var. *angustifolia*, *Haw. in Trans. Linn. Soc. vii. 13*, ab typo recedit et ad var. *angulatam* accedit, foliis paulo crassioribus facie deorsum concavis.

Var. G. ANGULATA, *Haw. in Phil. Mag.* 1827, 353.—*G. longifolia*, *Haw. Syn.* 88.—*Aloe angulata*, *Willd. in Berl. Mag. v. 256*; *Salm-Dyck, Aloe, sect. xxix. fig. 29*; *Kunth, Enum. iv. 546*.—*A. Lingua*, var. *longifolia*, *Haw. in Trans. Linn. Soc. vii. 13*. Folia crassiora quam in typo minus patentia margine uno solum interdum incrassato duplicato faciebus pallidioribus maculis interdum obscure seriatis, floribus paulo majoribus.

Var. G. NATALENSIS, *Baker*. Folia 6-8 lingulata pedalia vel sesquipedalia recurvata 2½-2¾ poll. lata læviora et firmiora quam in typo medio 2 lin. crassa utrinque planiuscula maculis obscurioribus magis viridulis. *Natal, McKen!*

8. G. SULCATA, *Haw. in Phil. Mag.* 1827, 353.—*Aloe sulcata*, *Salm-Dyck, Obs.* 54; *Aloe, sect. xxix. fig. 32*; *Kunth, Enum. iv. 545*.—*A. Lingua*, var. *angulata*, *Haw. in Trans. Linn. Soc. vii. 13*. Caulis foliiferus 1½-2-pollicaris. Folia 10-12 disticha vel subdisticha lorato-lingulata 6-8 poll. longa 1½ poll. lata medio 3 lin. crassa faciebus obscure pallide viridibus maculis copiosis minutis albidis immersis haud seriatis vetustate evanescentibus decoratis, apice obtuso cuspidato, marginibus sæpe duplicatis, basi dilatata anguste albido-cornea. Pedunculus simplex pedalis et ultra. Racemus pedalis, pedicellis inferioribus 5-6 lin. longis, bracteis minutis lanceolatis. Perianthium 9-10 lin. longum, tubo deorsum 3 lin. crasso. *C. B. Spei*, ante annum 1804 introducta.

9. G. MOLLIS, *Haw. Revis.* 46, 203; *Phil. Mag.* 1827, 350.—*Aloe mollis*, *Roem. et Schultes, Syst. vii. 665*; *Kunth, Enum. iv. 548*. Caulis foliiferus subpollicaris. Folia 6-8 disticha conferta patentia lingulata

3-4 poll. longa $1\frac{1}{2}$ poll. lata basi 3-4 lin. crassa facie superne plana deorsum concava utrinque obscure viridia maculis parvis viridulis obscuris immersis decorata, apice deltoideo-cuspidato, marginibus rugulosis, basi dilatata anguste albedo-cornea. Pedunculus simplex pedalis. Racemus subpedalis, pedicellis inferioribus 4-6 lin. longis, bracteis parvis lanceolatis. Perianthium 10 lin. longum, tubo deorsum 3 lin. crasso. *C. B. Spei*, in hortos anno 1819 a Bowie introducta.

10. *G. BICOLOR*, *Haw. in Phil. Mag.* 1826, 275.—*Aloe bicolor*, *Roem. et Schultes, Syst.* vii. 682; *Salm-Dyck, Aloe*, sect. xxix. fig. 5; *Kunth, Enum.* iv. 537. Caulis foliiferus 4-5-pollicaris. Folia 12-16 disticha conferta firma stricta omnia erecto-patentia lorata 6-9 poll. longa 15-18 lin. lata basi 5-6 lin. crassa viridia ubique lævia facie subplana dorso turghida maculis subnullis vel paucis obscuris dorso prope basin prædita, apice subdeltoideo cuspidato, marginibus vix tuberculatis, basi dilatata late rubello-cornea. Pedunculus simplex subpedalis. Racemi 8-12 poll. longi, pedicellis inferioribus 3-4 lin. longis, bracteis parvis lanceolatis. Perianthium 6-7 lin. longum, tubo oblongo pallide rubro $2-2\frac{1}{2}$ lin. crasso. *C. B. Spei*, circiter annum 1825 introducta.

11. *G. PLANIFOLIA*, *Baker.*—*Aloe planifolia*, *Baker in Saund. Ref. Bot.* t. 162. Caulis foliiferus 6-10-pollicaris. Folia 12-20 disticha laxè disposita firma stricta omnia erecto-patentia ensiformia 6-8 poll. longa 9-12 lin. lata deorsum 3 lin. medio 2 lin. crassa lævia nitide viridia, facie plana maculis copiosis magnis albis immersis confluentibus decorata, apice deltoideo-cuspidato corneo denticulato, margine haud tuberculato, basi dilatata caulem amplectente deltoidea perspicua. Pedunculus simplex pedalis et ultra. Racemus latus pedalis, pedicellis 5-6 lin. longis, bracteis parvis linearibus. Perianthium 9 lin. longum, tubo subgloboso 4 lin. crasso. *Algoa bay*, Cooper circiter annum 1860 introduxit. Ad *A. maculatam* accedens; recedit foliis perfecte distichis, perianthii tubo globoso.

12. *G. EXCAVATA*, *Haw. in Phil. Mag.* 1827, 253.—*Aloe excavata*, *Willd. in Berl. Mag.* v. 276; *Salm-Dyck, Monog.* sect. xxix. fig. 22; *Kunth, Enum.* iv. 545.—*A. obscura*, *Willd. in Berl. Mag.* v. 275.—*G. latifolia*, var. *multifaria*, *Haw. Syn.* 89.—*Aloe Lingua*, var. *multifaria*, *Haw. in Trans. Linn. Soc.* vii. 12.—*Aloe africana*, etc., *Miller, Ic.* t. 19. Caulis foliiferus $1\frac{1}{2}$ -2-pollicaris. Folia 12-16 densa patentia lingulata spiraliter disticha 4-5 poll. longa $1\frac{1}{2}$ -1 $\frac{1}{2}$ poll. lata basi 3 lin. medio 2 lin. crassa facie concava utrinque pallide viridia maculis parvis albo-viridibus obscuris immersis decorata apice deltoideo-cuspidata, marginibus tuberculatis margine uno sæpe duplicato, basi dilatata anguste albedo-cornea. Pedunculus simplex subpedalis. Racemus subpedalis, pedicellis inferioribus 5-6 lin. longis, bracteis parvis lanceolatis. Perianthium 10-12 lin. longum, tubo oblongo $2\frac{1}{2}$ lin. crasso. *C. B. Spei*, e temporibus remotis culta. *A. G. sulcata* præsertim recedit foliis maturis spiraliter distichis.

13. *G. SPIRALIS*, *Baker*. Caulis foliiferus 3-4 pollicaris. Folia 16-20 densa stricta omnia erecto-patentia spiraliter disticha lingulata 4-6 poll. longa 1-1½ poll. lata medio 3 lin. crassa facie turgida dorso rotundata ubique lævia nitida viridia vel purpureo tincta maculis copiosis albidis immersis magnitudine mediocribus vix confluentibus decorata apice obtusa cuspidata cornea subintegra, marginibus haud tuberculatis, basi dilatata rubello-cornea. Pedunculus simplex subpedalis. Racemus pedalis et ultra, pedicellis inferioribus 3-4 lin. longis, bracteis lanceolatis pedicello subæquilongis. Perianthium 9-10 lin. longum, tubo deorsum oblongo 3 lin. crasso. *C. B. Spei*. Verisimiliter est varietas *G. nigricantis* foliis spiraliter distichis.

Var. *TORTULATA*, *Baker*, a typo recedit foliis conspicue tortis e basi ad apicem magis angustatis.

14. *G. DICTA*, *N. E. Br. in Gard. Chron.* 1876, ii. 68. Caulis foliiferus 2-pollicaris. Folia 12-14 conferta spiraliter disticha patentia lorata 4-5 poll. longa 1½ poll. lata firma lævia obscure viridia basi 5-6 lin. crassa facie subplana apice deltoidea cornea denticulata marginibus tuberculato-rugosis, margine uno solum sæpe duplicato, ubique maculis parvis rotundis sparsis immersis decorata. Pedunculus pedalis et ultra simplex vel ramosus. Racemi subdensi pedales, pedicellis inferioribus 3-4 lin. longis, bracteis lanceolatis pedicello subæquilongis. Perianthium 9 lin. longum, tubo deorsum oblongo 3 lin. crasso. *C. B. Spei*. V. v. in hort. Kew. A *G. subnigricanti* præsertim recedit foliis spiraliter distichis duplicato-marginatis.

15. *G. RETATA*, *Haw. in Phil. Mag.* 1827, 349.—*Aloe dictyodes*, *Roem. et Schultes, Syst.* vii. 663; *Salm-Dyck, Aloe*, sect. xxix. fig. 4; *Kunth, Enum.* iv. 539. Caulis foliiferus tripollicaris. Folia 10-12 conferta spiraliter disticha exteriora patula interiora ascendentia ensiformia pedalia deorsum 15-18 lin. lata basi 5-6 lin. crassa facie plana superne corneo-marginata denticulata, margine uno solum duplicato, maculis parvis obscuris rotundis confluentibus immersis decorata. Pedunculus validus ramosus. Racemus 7-8-pollicaris, pedicellis inferioribus 3-4 lin. longis, bracteis minutis lanceolatis. Perianthium 9 lin. longum, tubo deorsum oblongo 3 lin. crasso. *C. B. Spei*, anno 1826 a Bowie introducta.

16. *G. CHEILOPHYLLA*, *Baker*.—*G. undata*, *Hort. non Haw.* Caulis foliiferus 2-pollicaris. Folia 14-18 densa spiraliter disticha exteriora patula interiora ascendentia ensiformia 9-10 poll. longa supra basin 1 poll. lata ad apicem lanceolato-cuspidatum angustata basi 3 lin. crassa saturate viridia facie valde concava marginibus corneo-tuberculatis, margine uno incrassato, utrinque maculis copiosis albidis magnitudine mediocribus leviter emersis subconfluentibus decorata. Flores mihi ignoti. *C. B. Spei*. V. v. in hort. Kew. et Peacock. Folia *G. pulchræ*; recedit caule foliifero brevi, foliis facie valde concavis, maculis minoribus subemersis. An sit hybrida inter *pulchram* et *verrucosam*?

17. *G. PALLESCENS*, Baker. Caulis foliiferus bipollicaris. Folia 8-10 conferta exteriora patula interiora erecto-patentia ensiformia semipedalia deorsum 1 poll. lata basi 5-6 lin. medio 3 lin. crassa lævia viridia facie sursum turgida dorso rotundata apice deltoidea cuspidata cornea denticulata, marginibus deorsum lævibus haud tuberculatis, ubique maculis albidoviridibus immersis copiosissimis confluentibus decorata. Pedunculus simplex pedalis et ultra. Racemus pedalis, pedicellis inferioribus 3-4 lin. longis, bracteis lanceolatis acuminatis pedicello subæquilongis. Perianthium 9 lin. longum, tubo deorsum oblongo 3 lin. crasso. *Algoa bay*, Cooper! circiter annum 1860 introduxit. V. v. in hort. Saunders.

18. *G. PORPHYROPHYLLA*, Baker. Caulis foliiferus 1½-2-pollicaris. Folia 8-10 densa erecto-patentia lorata 7-8 poll. longa 1 poll. lata sordide purpurea lævissima facie subplana apice cornea denticulata deltoideo-cuspidata, marginibus infra apicem haud tuberculatis, margine sinistro (e medio rosulæ spectante) duplicato, ubique maculis magnis albidis immersis confluentibus decorata. Pedunculus simplex pedalis. Racemus laxus pedalis, pedicellis inferioribus 3-4 lin. longis, bracteis lanceolatis acuminatis pedicello subæquilongis. Perianthium 9 lin. longum, tubo deorsum oblongo 3 lin. crasso. *C. B. Spei*. V. v. in hort. Kew. anno 1873. Ad *G. pallescentem* arete accedit. An sit varietas foliis purpurascensibus duplicato-marginatis?

19. *G. VARIOLOSA*, Baker in *Saund. Ref. Bot.* t. 347. Caulis foliiferus 1½-2-pollicaris. Folia 15-18 conferta spiraliter disticha exteriora patula vel recurvata interiora ascendentia sæpe torta omnia lorata 8-9 poll. longa 1½ poll. lata medio 3-4 lin. crassa firma lævia obscure viridia facie concava dorso turgida apice deltoideo-cuspidata cornea marginibus haud tuberculatis, margine uno sæpe duplicato, ubique maculis magnis oblongis albidis immersis confluentibus decorata. Pedunculus simplex subpedalis. Racemus sesquipedalis, pedicellis inferioribus 3-4 lin. longis, bracteis lanceolatis pedicello subæquilongis. Perianthium 9 lin. longum, tubo oblongo 3 lin. crasso. *Algoa bay*, Cooper! circiter annum 1860 introducta.

20. *G. ZEYHERI*, Baker.—*Aloe Zeyheri*, *Salm-Dyck*, *Aloe*, sect. xxix. fig. 3 bis. Caulis foliiferus semipedalis. Folia 16-20 laxè disposita ascendentia spiraliter disticha lorata 8-9 poll. longa 9-12 lin. lata deorsum 3-4 lin. crassa lævia facie plana apice deltoideo-cuspidata cornea denticulata marginibus lævibus haud duplicatis utrinque obscure viridia maculis parvis obscuris immersis decorata, basi valde dilatata plicata. Pedunculus simplex pedalis. Racemus pedalis, pedicellis inferioribus 3-4 lin. longis, bracteis parvis lanceolatis. Perianthium 9 lin. longum, tubo deorsum oblongo 3 lin. crasso. *C. B. Spei*.

21. *G. COLUBRINA*, *N. E. Brown in Gard. Chron.* 1877, viii. 38. Caulis foliiferus 3-6-pollicaris. Folia 8-10 spiraliter disticha vel in plantis senioribus multifaria lorata interdum pedalia 1½ poll. lata deorsum 4-6

lin. crassa lævia facie concava apice deltoideo-cuspidata, marginibus infra apicem lævibus, margine uno duplicato, utrinque viridia vel purpureo tincta maculis albidis immersis magnitudine mediocribus decorata. Inflorescentia 4-pedalis. Pedunculus validus bipedalis et ultra ramosus. Racemi pedales et ultra, pedicellis inferioribus 3-4 lin. longis, bracteis acuminatis pedicellum superantibus. Perianthium 8-9 lin. longum, tubo deorsum oblongo 3 lin. crasso. *C. B. Spei*, circiter annum 1870 a Bolus introducta.

22. *G. PICTA*, *Haw. in Phil. Mag.* 1827, 348.—*Aloe Bowiciana*, *Roem. et Schultes, Syst.* vii. 662; *Salm-Dyck, Aloe*, sect. xxix. fig. 3; *Kunth, Enum.* iv. 536. Caulis foliiferus semipedalis vel pedalis. Folia 12-20 spiraliter disticha omnia erecto-patentia lorata interdum pedalia et ultra $1\frac{1}{2}$ -2 poll. lata deorsum 5-6 lin. crassa nitide atroviridia facie subplana apice deltoidea cuspidata cornea marginata, marginibus infra apicem lævibus, margine uno interdum obscure duplicato, dorso rotundata maculis iis *maculatæ* et *picte* consimilibus sed paulo minoribus minus confluentibus magis viridulis immersis decorata, basi dilatata rubro-cornea. Pedunculus validus sæpe ramosus. Racemi pedales, pedicellis inferioribus 3-4 lin. longis, bracteis lanceolatis pedicello æquilongis. Perianthium 8-9 lin. longum, tubo oblongo 4 lin. crasso. *C. B. Spei*, anno 1827 a Bowie introducta.

Var. *G. FORMOSA*, *Haw. in Phil. Mag.* 1827, 349, ad *G. maculatam* accedit, foliis brevioribus angustioribus (1 poll. latis) superne magis angustatis, maculis magis confluentibus decoratis.

23. *G. PULCHRA*, *Haw. Syn.* 86.—*Aloe pulchra*, *Jacq. Hort. Schoen.* t. 419; *Haw. in Trans. Linn. Soc.* vii. 14; *Salm-Dyck, Aloe*, sect. xxix. fig. 2; *Kunth, Enum.* iv. 536.—*A. obliqua*, *DC. Plantes Grasses*, t. 91.—*A. maculata*, *Ker in Bot. Mag.* t. 765.—*Aloe* foliis linguiformibus variegatis, *Miller, Ic.* t. 298. Caulis foliiferus semipedalis et ultra. Folia 16-20 laxè disposita spiraliter disticha lævia omnia ascendentia interdum pedalia deorsum 9-12 lin. lata ensiformia ad apicem sensim angustata facie deorsum concava medio 3 lin. crassa apice lanceolata corneo-marginata, marginibus infra apicem haud tuberculatis, margine uno sæpe duplicato, utrinque nitidula viridula vel purpureo tincta maculis magnis albidis immersis copiosis confluentibus decorata. Pedunculus pedalis et ultra ramosus. Racemi pedales, pedicellis inferioribus 5-6 lin. longis, bracteis linearibus pedicello brevioribus. Perianthium 9 lin. longum, tubo deorsum oblongo 3 lin. crasso. *C. B. Spei*, a temporibus remotis culta.

24. *G. MACULATA*, *Haw. in Phil. Mag.* 1827, 348.—*Aloe maculata*, *Thunb. Diss.* No. 10, *ex parte*; *Salm-Dyck, Monog.* sect. xxix. fig. 1; *Kunth, Enum.* iv. 536.—*A. obliqua*, *Haw. in Trans. Linn. Soc.* vii. 14.—*A. maculata*, var. *obliqua*, *Soland. in Ait. Hort. Kew.* i. 469.—*A. Lingua*, *Ker in Bot. Mag.* t. 979, *excl. syn.*—*Gasteria obliqua*, *Haw. Syn.* 85.

Caulis foliiferus 6-9-pollicaris. Folia 16-20 laxè disposita spiraliter disticha omnia erecto-patentia lorata firma lævia nitida saturate viridia vel purpurea 4-6 poll. longa 9-12 lin. lata deorsum 3 lin. medio 2 lin. crassa sæpe torta facie plana apice cornea deltoideo-cuspidata, marginibus lævibus, margine uno sæpe duplicato, ubique maculis magnis albidis valde confluentibus immersis decorata, basi dilatata cornea rosea. Pedunculus pedalis et ultra simplex vel ramosus. Racemi pedales, pedicellis inferioribus 5-6 lin. longis, bracteis lanceolatis parvis. Perianthium 8-9 lin. longum, tubo oblongo 3 lin. crasso. *C. B. Spei*, a temporibus remotis culta. *Graaf-Reinet*, Bolus!

Var. *FALLAX*, *Haw.*, est forma minor, foliis 7-8 lin. latis maculis albidis copiosissimis.

25. *G. DECIPIENS*, *Haw. in Phil. Mag.* 1827, 356.—*Haworthia nigricans*, *Haw. in Phil. Mag.* 1824, 301.—*Aloe decipiens*, *Roem. et Schultes, Syst.* vii. 674; *Salm-Dyck, Aloe*, sect. xxix. fig. 16; *Kunth, Enum.* 539. Caulis foliiferus 1-1½-pollicaris. Folia 12-20 densa multifaria deltoidea 2-3 poll. longa basi 15-18 lin. lata 5-6 lin. crassa facie concava dorso inæquilateraliter carinata apice deltoidea utrinque obscure atroviridia tuberculis crebris subconcoloribus vel viridulis emersis rugosa. Pedunculus simplex subpedalis. Racemus pedalis, pedicellis inferioribus 3-4 lin. longis, bracteis parvis lanceolatis. Perianthium 11-12 lin. longum, tubo deorsum oblongo 3 lin. crasso. *C. B. Spei*, anno 1824 a *Bowie* introducta.

26. *G. CARINATA*, *Haw. Syn.* 87.—*Aloe carinata*, *Miller, Gard. Dict.* edit. vi. No. 21; *Haw. in Trans. Linn. Soc.* vii. 13; *Bot. Mag.* t. 1331, *ex parte*; *Salm-Dyck, Aloe*, sect. xxix. fig. 20; *Kunth, Enum.* iv. 543.—*Aloe africana sessilis foliis carinatis verrucosis*, *Dill. Elth.* t. 18. Caulis foliiferus 1-1½-pollicaris. Folia 15-20 multifaria densa exteriora patula interiora ascendunt omnia lanceolata 5-6 poll. longa basi 1½-2 poll. lata 5-6 lin. crassa facie concava dorso inæquilateraliter distincte carinata apice deltoideo-cuspidata cornea utrinque viridia tuberculis multis albis vel viridulis emersis crebris magnitudine mediocribus prædita, marginibus carinatae valde tuberculatis. Pedunculus simplex sesquipedalis. Racemus pedalis, pedicellis inferioribus 5-6 lin. longis, bracteis parvis lanceolatis. Perianthium 1 poll. longum, tubo deorsum oblongo 2-2½ lin. crasso. *C. B. Spei*, a temporibus remotis culta, *Zeyher* 4180! *G. STRIGATA*, *Haw. in Phil. Mag.* 1827, 356, est forma major tuberculis paucioribus subseriatis. *G. PARVA*, *Haw. loc. cit.*, est forma parva, tuberculis paucis sparsis.

27. *G. SUBCARINATA*, *Haw. in Phil. Mag.* 1827, 357.—*Aloe subcarinata*, *Salm-Dyck, Obs.* 51; *Monog.* sect. xxix. fig. 21; *Kunth, Enum.* iv. 541.—*A. pseudo-angulata*, *Salm-Dyck, Cat.* 16.—*G. undata*, *Haw. in Phil. Mag.* 1827, 357,—*Aloe undata*, *Roem. et Schultes, Syst.* vii. 677; *Kunth*,

Enum. iv. 541. Caulis foliiferus 1-1½-pollicaris. Folia 10-15 densa patentia lanceolata multifaria 4-6 poll. longa deorsum 1-1½ poll. lata facie leviter concava dorso inæquilateraliter carinata apice obtusa cuspidata cornea utrinque pallide viridia maculis albidis sparsis parvis leviter emersis decorata, marginibus carinaque prorsus tuberculato-dentatis. Pedunculus pedalis et ultra simplex. Racemus pedalis, pedicellis inferioribus 5-6 lin. longis, bracteis parvis lanceolatis. Perianthium 1 poll. longum, tubo deorsum oblongo 2½ lin. crasso. *C. B. Spei.* Inter *G. carinatum* et *distichum* medium tenens. Verisimiliter hybrida hortensis. *G. STRIGOSA*, *Hort. Peacock*, est forma foliis spiraliter distichis. Forma adest in hortis culta foliis albo variegatis.

28. *G. PETHAMENSIS*, *Hort.* Caulis foliiferus 1½-pollicaris. Folia 16-20 densa multifaria exteriora patula interiora ascendentia omnia lanceolata 3-4 poll. longa basi 9-10 lin. lata 3-4 lin. crassa facie concava dorso ad basin inæquilateraliter distincte carinata apice lanceolata corneo-marginata utrinque saturate viridia vel vetustate purpureo tincta maculis copiosis albidis leviter immersis sparsis magnitudine mediocribus decorata, marginibus carinaque crebre tuberculatis. Flores non vidi. *V. v. in hort. Kew. et Peacock.* Hybrida hortensis inter *Gasteriam verrucosam* et *Aloem variegatam* ad locum dictum Petham a Ricketts anno 1840 facta et a Masters disseminata. De historia vide 'Gard. Chron.' 1841, 183.

29. *G. PARVIFOLIA*, *Baker.* Caulis foliiferus brevis. Folia 10-12 densa multifaria lanceolato-deltoidea 2-2½ poll. longa basi 1-1½ poll. lata 5-6 lin. crassa viridia vetustate purpurascens facie concava dorso oblique carinata utrinque maculis copiosis parvis albidis confluentibus immersis decorata apice rotundata cuspidata corneo-marginata, marginibus carinaque corneo-tuberculatis. Flores non vidi. *C. B. Spei*, Cooper circiter annum 1860 introduxit. *V. v. in hort. Saunders. et Kew.*

30. *G. GRACILIS*, *Hort. Saunders.* Caulis foliiferus brevis. Folia 9-10 densa multifaria exteriora recurvata omnia lanceolata 3-4 poll. longa 9-10 lin. lata obscure viridia apice rotundata cuspidata margine corneo continuo, dorso oblique carinata utrinque maculis minutis albidis crebris immersis decorata, marginibus carinaque tuberculato-rugosis. Flores non vidi. *Natal*, Cooper circiter annum 1860 introduxit.

31. *G. LÆTEPUNCTA*, *Haw. in Phil. Mag.* 1827, 356.—*Aloe lætepunctata*, *Roem. et Schultes, Syst.* vii. 676; *Kunth, Enum.* iv. 357. Caulis foliiferus 1-1½-pollicaris. Folia 15-20 densa multifaria lanceolata 4-6 poll. longa basi 18-21 lin. lata 4-5 lin. crassa ad apicem angustata facie concava apice deltoideo-cuspidata corneo-marginata dorso inæquilateraliter carinata utrinque viridia vel purpurascens maculis copiosis sparsis albis iis *G. trigonæ* majoribus decorata, marginibus carinaque tuberculato-rugosis. Pedunculus subpedalis simplex vel furcatus. Racemus 8-12-pollicaris, pedicellis 3-4 lin. longis, bracteis lanceolatis pedicello æquilongis. Peri-

anthium 10-11 lin. longum, tubo deorsum oblongo 3 lin. crasso. *C. B. Spei*, circiter annum 1825 a Bowie introducta.

32. *G. OBTUSA*, *Haw. in Phil. Mag.* 1827, 358.—*Aloe obtusa*, *Roem. et Schultes, Syst.* vii. 679.—*A. trigona*, *Salm-Dyck, Monogr.* sect. xxix. fig. 18; *Kunth, Enum.* iv. 540.—*A. trigona*, var. *obtusa*, *Salm-Dyck, Obs.* 46. Caulis foliiferus $1\frac{1}{2}$ -2-pollicaris. Folia 12-18 densa multifaria exteriora recurvata interiora erecto-patentia lanceolata semipedalia basi $1\frac{1}{2}$ poll. lata $\frac{1}{2}$ poll. crassa facie concava apice deltoideo-cuspidata dorso prorsus inæquilateraliter carinata obscure viridia maculis copiosis albidis immersis iis *G. distichæ* consimilibus decorata, marginibus carinaque tuberculato-rugosis. Pedunculus pedalis et ultra simplex. Racemus subpedalis, pedicellis 3-4 lin. longis, bracteis lanceolatis pedicello æquilongis. Perianthium 9-10 lin. longum, tubo deorsum oblongo 3 lin. crasso. *C. B. Spei*, circiter annum 1820 introducta. Ad *G. glabram* arcte accedit.

33. *G. GLABRA*, *Haw. Syn.* 87; *Phil. Mag.* 1827, 357.—*Aloe glabra*, *Salm-Dyck, Obs.* 48; *Monogr.* sect. xxix. fig. 19; *Roem. et Schultes, Syst.* vii. 677; *Kunth, Enum.* iv. 540.—*Aloe carinata*, var. *subglabra*, *Haw. in Trans. Linn. Soc.* vii. 14.—*A. carinata*, *Ker in Bot. Mag.* t. 1331, fig. sinistra. Caulis foliiferus $1\frac{1}{2}$ -2 poll. Folia 15-18 densa multifaria exteriora recurvata interiora erecto-patentia lanceolata 6-9 poll. longa basi 2-3 poll. lata 6-9 lin. crassa facie concava apice deltoideo-cuspidata corneo-marginata dorso inæquilateraliter carinata utrinque nitide viridia maculis copiosis parvis albidis sparsis immersis decorata, marginibus carinaque tuberculato-rugosis. Pedunculus simplex subpedalis. Racemus pedalis et ultra 40-50-florus, pedicellis 3-4 lin. longis, bracteis parvis lanceolatis. Perianthium 1 poll. longum, tubo deorsum oblongo 3 lin. crasso. *C. B. Spei*, versus annum 1796 a Masson introducta. Var. *МАЈОР*, *Kunth*, est forma robusta, foliis pedibus 3-3 $\frac{1}{2}$ poll. latis 1 poll. crassis.

34. *G. TRIGONA*, *Haw. in Phil. Mag.* 1827, 358.—*Aloe trigona*, var. *elongata*, *Salm-Dyck, Obs.* 45.—*Aloe elongata*, *Salm-Dyck, Monogr.* sect. xxix. fig. 15; *Kunth, Enum.* iv. 539.—Caulis foliiferus $1\frac{1}{2}$ -2-pollicaris. Folia 12-15 densa multifaria exteriora patula interiora erecto-patentia ensiformia 7-8 poll. longa 15-18 lin. lata basi 5-6 lin. crassa facie concava dorso prorsus inæquilateraliter carinata apice lanceolata utrinque viridia maculis parvis albidis copiosis immersis decorata, marginibus carinaque tuberculato-rugosis. Pedunculus pedalis et ultra simplex vel furcatus. Racemus pedalis, pedicellis 3-4 lin. longis, bracteis pedicello æquilongis. Perianthium 2-10 lin. longum, tubo deorsum oblongo 3 lin. crasso. *C. B. Spei*, a Swellingreben versus annum 1790 introducta.

35. *G. MARMORATA*, *Hort. Peacock*. Caulis foliiferus 6-9-pollicaris, 15-18 lin. diam. Folia 20-30 densa multifaria lorata 5-6 poll. longa basi 15-18 lin. lata 3-4 lin. crassa obscura viridia ubique lævia maculis magnis

obscuris confluentibus immersis decorata apice rotundata cuspidata, marginibus lævibus, margine uno duplicato. Pedunculus pedalis et ultra, furcatus. Racemus pedalis, pedicellis 3-4 lin. longis, bracteis parvis lanceolatis. Perianthium 9-10 lin. longum, tubo 3 lin. crasso. *V. v. in hort. Peacock.* Ad *G. Bowieanam* accedit; recedit foliis minoribus multifariis distincte duplicato-marginatis, maculis obscurioribus.

36. *G. NITIDA*, *Haw. in Phil. Mag.* 1827, 358.—*Aloe nitida*, *Salm-Dyck, Cat.* 13; *Bot. Mag.* t. 2304; *Salm-Dyck, Monog.* sect. xxix. fig. 17; *Kunth, Enum.* iv. 539. Caulis foliiferus 1½-2-pollicaris. Folia 12-15 densa multifaria, exteriora patula, interiora ascendente, omnia lanceolata 8-9 poll. longa basi 2-2½ poll. lata 6-9 lin. crassa ad apicem deltoideo-cuspidatum sensim angustata nitide viridia facie concava dorso oblique carinata utrinque maculis copiosis parvis albidis decorata, marginibus carinaque vix rugosis. Pedunculus simplex pedalis et ultra. Racemus pedalis vel sesquipedalis, pedicellis 3-4 lin. longis, bracteis lanceolatis pedicello subæquilongis. Perianthium 1 poll. longum, tubo deorsum oblongo 3 lin. crasso. *C. B. Spei*, versus annum 1790 introducta. *Var. GRANDIPUNCTATA*, *Haw.* est forma maculis majoribus.

37. *G. FUSCOPUNCTATA*, *Baker.* Caulis foliiferus 2-3 poll. longus, 2-3 poll. diam. Folia 20-30 densa multifaria omnia stricta ascendente lanceolata 6-10 poll. longa basi 2½-3 poll. lata 9-12 lin. crassa e basi ad apicem rotundatum cuspidatum angustata obscure viridia lævia maculis paucis albidis et pluribus fuscis immersis decorata facie leviter concava, marginibus lævibus, margine uno duplicato. Pedunculus simplex sesquipedalis. Racemus bipedalis, pedicellis 3-4 lin. longis, bracteis lanceolatis 1½-2 lin. longis. Perianthium 1 poll. longum, tubo deorsum oblongo 3-4 lin. crasso. *C. B. Spei*, Cooper versus annum 1860 introduxit.

38. *G. EXCELSA*, *Baker.* Caulis foliiferus bipollicaris. Folia 20-30 densa multifaria, exteriora patula, interiora erecto-patentia, omnia lanceolata pedalia basi 3 poll. lata 6-9 lin. crassa e basi ad apicem deltoideo-cuspidatum sensim attenuata facie concava dorso oblique carinata utrinque obscure viridia maculis paucis albido-viridulis obscuris immersis decorata, marginibus sublævibus. Inflorescentia 3-4-pedalis, racemis 8-10, ramis inferioribus compositis, pedicellis 3-4 lin. longis, bracteis lanceolatis pedicellis æquilongis. Perianthium 9-10 lin. longum, tubo deorsum oblongo 4 lin. crasso. *C. B. Spei ad ripas fluminis Chalamna*, Cooper versus annum 1860 introduxit.

39. *G. PEACOCKII*, *Hort.* Caulis foliiferus 2-3 poll. longus. Folia 12-15 densa multifaria, exteriora squarrosa, interiora ascendente, lanceolata 9-12 poll. longa basi 2 poll. lata 6-9 lin. crassa ad apicem deltoideo-cuspidatum sensim angustata facie concava dorso sursum oblique carinata utrinque viridia maculis paucis albis immersis sparsis præsertim dorsalibus

decorata, marginibus tuberculis albidis corneis emeris crebris rugosis. Flores ignoti. *Inter G. ensifoliam et Aloem heteracantham hybrida hortensis a Pfersdorff facta.*

40. *G. ACINACIFOLIA*, *Haw. Suppl.* 49.—*Aloe acinacifolia*, *Jacq. Ecl.* 49, t. 31; *Ker in Bot. Mag.* t. 2369; *Salm-Dyck, Monog.* sect. xxix. fig. 11; *Kunth, Enum.* iv. 537. Caulis foliiferus $1\frac{1}{2}$ –2-pollicaris. Folia 10–12 densa multifaria stricta, exteriora patula, interiora ascendente, ensiformia pedalia et ultra basi $1\frac{1}{2}$ –2 poll. lata 6–9 lin. crassa ad apicem acuminatum sensim attenuata lævia nitide saturate viridia facie leviter concava dorso inæquilateraliter concava utrinque maculis parvis viridulis immersis copiosis decorata, marginibus medio leviter tuberculato-rugosis. Inflorescentia ramosa 3–4-pedalis, racemis pedibus et ultra, pedicellis 4–6 lin. longis, bracteis lanceolatis pedicello brevioribus. Perianthium $1\frac{1}{2}$ –2 poll. longum, tubo oblongo-cylindrico 3–4 lin. crasso. *C. B. Spei*, ante annum 1810 introducta. *G. VENUSTA*, *Haw. in Phil. Mag.* 1827, 359, est forma foliis angustioribus nitidissimis maculis albidioribus obscure fasciatis.

Var. *G. ENSIFOLIA*, *Haw. in Phil. Mag.* 1825, 282.—*Aloe ensifolia*, *Roem. et Schultes, Syst.* vii. 681; *Salm-Dyck, Monog.* sect. xxix. fig. 12; *Kunth, Enum.* iv. 538. Folia breviora apice minus acuminata. *G. PLURIPUNCTA*, *Haw. in Phil. Mag.* 1827, 359, est forma adolescens, foliis paucis subdistichis loratis obtusis dorso haud carinatis basi 3 lin. crassis maculis copiosis distinctis minutis albidis.

Var. *G. NITENS*, *Haw. Suppl.* 48.—*Aloe nitens*, *Roem. et Schultes, Syst.* vii. 680; *Kunth, Enum.* iv. 538. Folia latiora interdum sesquipedalia quam in typo minus acuminata basi 2–3 poll. lata lævissima læte viridia maculis copiosis confluentibus marmorata.

41. *G. CANDICANS*, *Haw. in Phil. Mag.* 1827, 360.—*Aloe candicans*, *Roem. et Schultes, Syst.* vii. 681; *Salm-Dyck, Monog.* sect. xxix. fig. 13; *Kunth, Enum.* iv. 538. Caulis foliiferus $1\frac{1}{2}$ –pollicaris. Folia 12–20 densa multifaria lanceolata, exteriora recurvata, interiora ascendente, 6–15 poll. longa basi $2\frac{1}{2}$ –3 poll. lata 6–8 lin. crassa nitide viridia facie concava dorso inæquilateraliter carinata utrinque maculis parvis albidis copiosis immersis decorata apice deltoideo-cuspidata, marginibus vix tuberculato-rugosis. Inflorescentia 3–4-pedalis ramosa, pedunculo crasso ancipiti, racemis 5–6 pedibus et ultra, pedicellis 3–4 lin. longis, bracteis parvis lanceolatis. Perianthium $1\frac{1}{2}$ –2 poll. longum, tubo cylindrico 3 lin. crasso. *C. B. Spei*, versus annum 1820 introducta. *G. LINITA*, *Haw. loc. cit.* vix ab typo recedit.

42. *G. CROUCHERI*, *Baker*.—*Aloe Croucheri*, *Hook. fl. in Bot. Mag.* t. 5812. Caulis foliiferus $1\frac{1}{2}$ –2-pollicaris. Folia 15–18 densa multifaria, exteriora recurvata, interiora ascendente, lanceolata 12–15 poll. longa basi

3-3½ poll. lata 9-12 lin. crassa ad apicem deltoideo-cuspidatum sensim angustata facie concava dorso oblique carinata utrinque lævia saturate viridia maculis copiosis parvis albo-viridulis decorata, marginibus lævibus vel leviter rugulosis. Inflorescentia 2½-3-pedalis ramosa, racemis laxis pedibus et ultra, pedicellis 5-6 lin. longis, bracteis lanceolatis pedicello brevioribus. Perianthium 21-24 lin. longum, tubo cylindrico 3 lin. crasso. *C. B. Spei*, versus annum 1860 introducta.

43. *G. BAYFIELDII*, *Baker*.—*Aloe Bayfieldii*, *Salm-Dyck*, *Aloe*, sect. xxix. fig. 14; *Kunth*, *Enum.* iv. 538. Caulis foliiferus 2-pollicaris. Folia 12-14 multifaria densa omnia ascendentia lanceolata 3-4 poll. longa basi 10-12 lin. lata 3 lin. crassa facie leviter concava dorso sursum oblique carinata e basi ad apicem acutum angustata utrinque viridia tuberculis copiosis crebris albidis subimmersis magnitudine mediocribus decorata, marginibus regulariter albido-corneis vel tuberculatis. Pedunculus simplex gracilis 12-15-pollicaris. Racemus laxis semipedalis vel pedalis, pedicellis ascendentibus 2-3 lin. longis, bracteis lanceolatis pedicello æquilongis. Perianthium 7-8 lin. longum, tubo 2 lin. crasso, segmentis ligulatis apice patulis. *V. v. in Hort. Kew., Corderoy, &c.*

44. *G. APICROIDES*, *Baker*. Caulis foliiferus semipedalis et ultra. Folia 20-30 multifaria ascendentia lanceolata torta 4-6 poll. longa basi 12-15 lin. lata 3-4 lin. crassa ad apicem deltoideum cuspidatum sensim attenuata facie concava dorso sursum oblique carinata utrinque saturate viridia maculis copiosis sparsis subimmersis magnitudine mediocribus decorata, marginibus rugosis tuberculatis. Inflorescentia 2-3-pedalis, ramis 4-6. Racemus terminalis sesquipedalis, pedicellis ascendentibus 2-3 lin. longis, bracteis lanceolatis pedicello æquilongis. Perianthium 7-8 lin. longum, tubo oblongo 2 lin. crasso, segmentis ligulatis apice patulis. *V. v. in Hort. Kew., Peacock, etc.*

45. *G. SQUARROSA*, *Baker*. Caulis foliiferus semipedalis. Folia circiter 20 multifaria lanceolata squarrosa 4-5 poll. longa basi 1 poll. lata 3 lin. crassa ad apicem subpungentem sensim angustata facie profunde concava dorso rotundata utrinque viridia tuberculis paucis obscuris albidis immersis decorata, marginibus albidis continuis corneis elevatis crebre denticulatis. Inflorescentia 2-2½-pedalis, ramis 4. Racemus terminalis pedalis laxis 2 poll. diam., pedicellis inferioribus patulis rubellis 3 lin. longis, bracteis lanceolatis pedicello æquilongis vel paulo longioribus. Perianthium oblongum 8-9 lin. longum, tubo oblongo 2 lin. diam., segmentis ligulatis tubo æquilongis. *V. v. in Hort. Kew. anno 1879.*

3. HAWORTHIA, *Duval*.

Duval, *Pl. Succ. Hort. Alanc.* 7; *Haw. Syn.* 90, *Suppl.* 70; *Baker in Gard. Chron.* 1879, 717.—*Aloe*, *Linn. Gen.* No. 430,

ex parte; *Salm-Dyck, Monog. Aloe*, sect. i.-xiii.; *Kunth, Enum.* iv. 492, *ex parte*.—*Apicra, Willd. ex parte*.—*Catevala, Medic. ex parte*.

Perianthium albidum interdum leviter rubro tinctum, tubo gamophyllo oblongo, limbo bilabiato segmentis 6 ligulatis obtusis viridi vittatis, flore expanso 3 superioribus subrectis 3 inferioribus squarrosis. *Stamina* 6 hypogyna perianthio semper distincte breviora, filamentis filiformibus, antheris minutis globosis versatilibus. *Ovarium* sessile oblongum triloculare, ovulis in loculo crebris superpositis, stylo subrecto filiformi ovario subæquilongo, stigmatibus capitato trilobato. *Capsula* oblongo-triquetra chartacea loculicido-trivalvis, apice umbilicata; seminibus multis obliquis discoideis alatis, testa brunnea membranacea, albumine carnosio, embryone axili. *Herbæ humiles suffruticosæ, rosulis foliorum nunquam pedunculatis, foliis brevibus latis crassis carnosis dense imbricatis multifariis vel raro trifariis, caule foliifero brevi vel producto, pedunculo nudo simplici vel ramoso, floribus parvis laxè racemosis, bracteis parvis persistentibus.*

Caulis foliiferus elongatus.

Stirps *Triquetra*. Folia regulariter trifaria immaculata.

Folia facie subplana.

1. *H. cordifolia.* 2. *H. asperiuscula.*

Folia facie excavata 3. *H. viscosa.*

Stirps *Tortuosæ*. Folia spiraliter trifaria immaculata.

4. *H. tortuosa.* 5. *H. subrigida.*

Stirps *Papillosæ*. Folia multifaria, tuberculis margaritaceis vel maculis decorata.

Tubercula margaritacea multa prominula.

6. *H. papillosa.* 7. *H. Reinwardtii.*

Tubercula margaritacea pauca parva subimmersa.

8. *H. coarctata.* 9. *H. Greenii.*

Maculæ crebræ immersæ 10. *H. Peacockii.*

Stirps *Hybridæ*. Folia multifaria immaculata.

Folia scabra.

11. *H. hybrida.* 12. *H. rigida.* 13. *H. nigra.*

Folia lævia 14. *H. glauca.*

Caulis foliiferus brevis. Folia multifaria integra, tuberculis margaritaceis decorata. Stirps *Margaritifera*.

Tubercula margaritacea regulariter transversaliter seriata.

15. *H. attenuata.* 16. *H. fasciata.* 17. *H. subfasciata.*

Tubercula margaritacea magna vel magnitudine mediocria
haud regulariter fasciata.

18. *H. margaritifera*. 19. *H. semiglabrata*.
20. *H. subattenuata*. 21. *H. glabrata*.

Tubercula margaritacea parva creberrima.

22. *H. subulata*. 23. *H. Radula*. 24. *H. rugosa*.

Caulis foliiferus brevis. Folia multifaria integra, tuberculis mar-
garitaceis nullis prædita.

Stirps *Virescentes*. Folia firma facie sursum haud recurvata.

Folia utrinque lævia 25. *H. albicans*.

Folia utrinque scabra.

26. *H. scabra*. 27. *H. sordida*.
28. *H. icosiphylla*. 29. *H. Tisleyi*.

Vide etiam *H. glabrata* var. *concolor*.

Stirps *Recurvæ*. Folia crassa facie sursum valde recurvata.

Folia dorso scabra 30. *H. recurva*.

Folia dorso lævia.

31. *H. asperula*. 32. *H. retusa*.
33. *H. turgida*. 34. *H. cuspidata*.

Stirps *Mucronatæ*. Folia lævia pallide viridia, sursum lineolata
haud recurvata.

35. *H. cymbiformis*. 36. *H. altilinea*. 37. *H. reticulata*.

Caulis foliiferus brevis. Folia multifaria margine denticulata vel
ciliato-dentata.

Stirps *Chloracanthæ*. Folia coriacea denticulata haud lineata.

38. *H. angolensis*. 39. *H. angustifolia*. 40. *H. chloracantha*.

Stirps *Tessellatæ*. Folia coriacea denticulata facie tessellata
recurvata. 41. *H. tessellata*. 42. *H. venosa*.

Stirps *Denticulatæ*. Folia denticulata apice lineata.

Folia deltoidea 43. *H. mirabilis*.

Folia ovata 44. *H. subregularis*.

Folia oblongo-lanceolata.

45. *H. atrovirens*. 46. *H. lætevirens*.
47. *H. denticulata*. 48. *H. bilineata*.
49. *H. affinis*. 50. *H. polyphylla*.
51. *H. vittata*.

Stirps *Pallidæ*. Folia pallida breviter setoso-dentata, apice
sæpissime aquoso-pellucida lineata.

52. *H. translucens*. 53. *H. pallida*.
54. *H. filifera*. 55. *H. Cooperi*.
56. *H. minima*.

Stirps *Arachnoideæ*. Folia pallida longe setoso-dentata, apice sæpissime aquoso-pellucida lineata.

57. *H. arachnoides*. 58. *H. Bolusii*.

59. *H. setata*.

1. *H. CORDIFOLIA*, *Haw. Suppl.* 60.—*Aloe cordifolia*, *Roem. et Schultes, Syst.* vii. 653; *Salm-Dyck*, sect. iii. tab. 1; *Kunth, Enum.* iv. 496. Rosula foliorum semipedalis 2-2½ poll. diam. Folia trifaria omnia erecto-patentia ovata acuta 15-18 lin. longa 1 poll. lata atroviridia immaculata, juniora facie concava, seniora planiuscula, 4-5 lin. crassa dorso turgida scabra sursum carinata. Pedunculus simplex semipedalis. Racemus laxissimus semipedalis pauciflorus, pedicellis erecto-patentibus 5-6 lin. longis, bracteis minutis deltoideis. Perianthium 8-9 lin. longum, segmentis quam tubus duplo brevioribus. *C. B. Spei*, in hortis europæis a Mackrell anno 1818 introducta.

2. *H. ASPERIUSCULA*, *Haw. Suppl.* 60.—*Aloe asperiuscula*, *Roem. et Schultes, Syst.* vii. 653; *Salm-Dyck, Aloe*, sect. iii. fig. 2; *Kunth, Enum.* iv. 496. Rosula foliorum semipedalis 15-18 lin. diam. Folia trifaria omnia ascendentia deltoidea acuta 9-10 lin. longa 7-8 lin. lata medio 4-5 lin. crassa atroviridia immaculata facie deorsum concava dorso turgida scabra superne carinata. Pedunculus simplex semipedalis. Racemus laxissimus pauciflorus semipedalis, pedicellis ascendentibus 5-6 lin. longis, bracteis minutis deltoideis. Perianthium 7-8 lin. longum, segmentis quam tubus duplo brevioribus. *C. B. Spei*, in hortis anno 1818 a Mackrell introducta.

3. *H. VISCOSA*, *Haw. Syn.* 90.—*Aloe viscosa*, *Linn. Sp.* 460 (*Dill. Elth.* tab. 13); *DC. Plantes Grasses*, t. 16; *Bot. Mag.* t. 814; *Salm-Dyck, Aloe*, sect. iii. fig. 3.—*Apicra viscosa*, *Willd. in Berl. Mag.* v. 274.—*Aloe triangularis*, *Lam. Encyc.* i. 89. Rosula foliorum semipedalis vel pedalis 15-18 lin. diam. Folia trifaria omnia ascendentia apice leviter recurvata arcte imbricata ovata acuta atroviridia immaculata 12-15 lin. longa 5-6 lin. lata medio 1½-2 lin. crassa facie profunde excavata dorso turgida superne carinata leviter scabrula interdum viscosa. Pedunculus simplex gracillimus semipedalis. Racemus laxissimus 6-9-pollicaris pauciflorus, pedicellis erecto-patentibus 2-3 lin. longis, bracteis minutis lanceolatis. Perianthium 7-8 lin. longum, segmentis quam tubus duplo brevioribus. *C. B. Spei, Graaf-Reinet, alt. 2700 pedum*, *Bolus 559*!

Var. *H. INDURATA*, *Haw. Revis.* 49 (*Aloe viscosa indurata*, *Salm-Dyck, Aloe*, sect. iii. fig. 3β), ad *H. cordifoliam* accedit foliis paucioribus crassioribus majoribus facie minus excavatis. *C. B. Spei*, in anno 1818 a Mackrell introducta.

Var. *H. CONCINNA*, *Haw. Suppl.* 59.—*Aloe concinna*, *Roem. et Schultes*,

Syst. vii. 653; *Salm-Dyck, Aloe*, sect. iii. fig. 4, Folia longiora ($1\frac{1}{2}$ poll, longa) magis recurvata facie profunde excavata. *C. B. Spei*.

Var. H. PSEUDO-TORTUOSA, *Haw. Suppl.* 59.—*Aloe subtortuosa, Salm-Dyck, Aloe*, sect. iii. fig. 5, a typo solum recedit foliis spiraliter trifariis.

Var. H. TORQUATA, *Haw. in Phil. Mag.* 1827, 124.—*Aloe torquata, Salm-Dyck, Aloe*, sect. iii. fig. 6. Folia spiraliter trifaria ovato-lanceolata 18–24 lin. longa facie profunde excavata.

4. H. TORTUOSA, *Haw. Syn.* 90.—*Aloe tortuosa, Haw. in Trans. Linn. Soc.* vii. 7; *Roem. et Schultes, Syst.* vii. 655; *Salm-Dyck, Aloe*, sect. iv. fig. 2.—*A. rigida, Bot. Mag.* t. 1337, non DC. Rosula foliorum semipedalis 2–3 poll. diam. Folia spiraliter trifaria ovato-lanceolata omnia ascendunt $1\frac{1}{2}$ –2 poll. longa 8–9 lin. lata atroviridia immaculata medio 3–4 lin. crassa facie excavata dorso turgida superne carinata apice subpungentia dorso et margine tuberculis minutis copiosissimis concoloribus scabrula. Pedunculus simplex vel furcatus. Racemi laxissimi subsecundi 6–9 poll. longi, pedicellis $1\frac{1}{2}$ –3 lin. longis, bracteis minutis lanceolatis. Perianthium 7–8 lin. longum rubro tinctum, segmentis quam tubus duplo brevioribus. *C. B. Spei*, in hortis anglis anno 1794 introducta. Var. MAJOR, *Salm-Dyck*, est forma foliis 2–2 $\frac{1}{2}$ poll. longis; H. CURTA, *Haw. Suppl.* 60, forma humilior, foliis subuncialibus saturatoribus; H. TORTELLA, *Haw. Suppl.* 61, forma foliis numerosioribus nigricantibus, caule valde tortuoso basi valde ramoso.

5. H. SUBRIGIDA, *Baker*.—*Aloe subrigida, Salm-Dyck, Aloe*, sect. iv. fig. 1.—*A. pseudo-rigida, Salm-Dyck, Cat.* 9 et 41.—*Apicra pseudo-rigida, Haw. Suppl.* 62.—*Aloe rigida, Jacq. Fragm.* t. 108, non DC. Rosula foliorum semipedalis et ultra $2\frac{1}{2}$ –3 poll. diam. Folia spiraliter trifaria ovato-lanceolata recurvata $1\frac{1}{2}$ –2 poll. longa 6–8 lin. lata medio 2–3 lin. crassa concoloria immaculata atroviridia facie concava dorso turgida superne carinata utrinque tuberculis creberrimis quam ii *H. tortuosæ* majoribus apice albo-tinctis scabra. Pedunculus semipedalis et ultra interdum ramosus. Racemi laxissimi semipedales, pedicellis $1\frac{1}{2}$ –2 lin. longis, bracteis minutis lanceolatis. Perianthium 7–8 lin. longum rubro tinctum, segmentis quam tubus duplo brevioribus. *C. B. Spei*, in hortis nostris anno 1818 introducta. Inter *rigidam* et *tortuosam* medium tenens, foliis dorso valde rugosis prioris, caule foliifero elongato foliorum seriebus spiraliter tortis posterioris.

6. H. PAPILLOSA, *Haw. Suppl.* 58.—*Aloe papillosa, Salm-Dyck, Cat.* 7; *Monogr.* sect. vi. fig. 4; *Kunth, Enum.* iv. 501. Rosula foliorum interdum pedalis 5–6 poll. diam. Folia 50 vel ultra multifaria ascendunt ovato-lanceolata acuminata 3–4 poll. longa basi 15–18 lin. lata 5–6 lin. crassa facie turgida dorso rotundata apice obscure carinata utrinque viridia tuberculis magnis margaritaceis emersis haud seriatis decorata. Pedunculus pedalis vel sesquipedalis ramosus. Racemus semipedalis, pedicellis ascen-

dentibus 1-1½ lin. longis, bracteis minutis deltoideis. Perianthium 7-8 lin. longum, segmentis quam tubus duplo brevioribus. *C. B. Spei*, in hortis nostris ante annum 1750 introducta. Var. SEMIPAPILLOSA, *Haw. Rev.* 55, est forma minor, foliis facie vix tuberculatis. A formis magnis *H. margaritifera* vix recedit nisi caule foliifero producto.

7. H. REINWARDTII, *Haw. Rev.* 53.—*Aloe Reinwardtii*, *Salm-Dyck*, *Obs.* 1821, 37; *Monogr.* sect. vi. fig. 16; *Kunth*, *Enum.* iv. 506. Rosula foliorum 4-6-pollicaris 1½-2 poll. diam. Caules cæspitiosi. Folia ascendentia multifaria ovato-lanceolata 1-1½ poll. longa 5-6 lin. lata deorsum 3 lin. crassa facie turgida viridia lævia immaculata vel parce maculata dorso rotundata tuberculis emersis albis ¼ lin. diam. verticaliter et transversaliter seriatis, seriebus verticalibus 9-11, apice obscure carinata. Pedunculus simplex semipedalis. Racemus latus pauciflorus semipedalis, pedicellis 2-3 lin. longis, bracteis minutis lanceolatis. Perianthium 7-8 lin. longum, segmentis quam tubus duplo brevioribus. *C. B. Spei*, in hortis anno 1818 introducta. Var. MINOR, *Hort.*, est forma foliis 9-12 lin. longis tuberculis formæ typicalis. Var. MAJOR, *Hort.*, est forma foliis crebrioribus tuberculis multo majoribus ½ lin. diam.

8. H. COARCTATA, *Haw. in Phil. Mag.* 1824, 301.—*Aloe coarctata*, *Roem. et Schultes*, *Syst.* vii. 647; *Salm-Dyck*, *Monogr.* sect. vi. 17; *Kunth*, *Enum.* iv. 506. Rosula foliorum 4-8-pollicaris 2-3 poll. diam. basi ramosa. Folia multifaria ascendentia ovato-lanceolata acuminata 2-2½ poll. longa basi 8-9 lin. lata 3-4 lin. crassa facie plana vel turgida lævia immaculata dorso valde rotundata obscure verticaliter striata tuberculis parvis albidis subimmersis verticaliter seriatis decorata sursum carinata. Pedunculus simplex semipedalis. Racemus simplex latus semipedalis, pedicellis erecto-patentibus 1-2 lin. longis, bracteis minutis deltoideis. Perianthium 8-9 lin. longum, segmentis quam tubus duplo brevioribus. *C. B. Spei*, in hortis nostris a Bowie anno 1822 introducta.

9. H. GREENII, *Baker*. Rosula foliorum 6-8-pollicaris 2 poll. diam. Folia ascendentia multifaria lanceolato-deltoidea 15-16 lin. longa 9-10 lin. lata medio 3-4 in. crassa facie plana lævia immaculata dorso rotundata dimidio superiore leviter carinata obscure verticaliter lineata maculis paucis immersis albis verticaliter seriatis decorata. Flores ignoti. *C. B. Spei*. V. v. in hort. Peacock 1879. Ad *H. coarctatam* arcte accedit; recedit foliis brevioribus tuberculis minoribus paucioribus interdum obsoletis.

10. H. PEACOCKII, *Baker*. Rosula foliorum 6-9-pollicaris 2-2½ poll. diam. Folia multifaria deltoidea ascendentia 10-12 lin. longa et lata medio 2-3 lin. crassa omnia facie concava apice subpungentia utrinque lævia viridia maculis copiosis parvis immersis albido-viridibus inæqualibus haud seriatis decorata, dorso superne suboblique carinata, marginibus rugosis. Flores ignoti. *C. B. Spei*? V. v. in hort. Kew. et Peacock, anno 1879.

11. *H. HYBRIDA*, *Haw. Revis.* 51.—*Aloe hybrida*, *Salm-Dyck, Cat.* 7; *Monogr. sect. iv. fig. 4*; *Kunth, Enum.* iv. 499. Rosula foliorum 3-4-pollicaris 2-3 poll. diam., basi ramosa. Folia 20-30 multifaria ovato-lanceolata 12-18 lin. longa 6-8 lin. lata 3 lin. crassa sordide viridia facie subplana dorso rotundata deorsum oblique carinata utrinque tuberculis creberrimis parvis emersis apice albo tinctis rugosa. Pedunculus pedalis et ultra ramosus. Racemi laxi semipedalis, pedicellis ascendentibus 1-1½ lin. longis, bracteis minutis lanceolatis. Perianthium 8-9 lin. longum, segmentis quam tubus duplo brevioribus. *C. B. Spei?* In hortis ab anno 1814 culta.

12. *H. RIGIDA*, *Haw. Revis.* 49.—*Aloe rigida*, *DC. Plantes Grasses*, t. 62; *Roem. et Schultes, Syst.* vii. 655; *Salm-Dyck, Monog. sect. iv. fig. 3*; *Kunth, Enum.* iv. 499.—*H. expansa*, *Haw. Syn.* 91.—*Aloe expansa*, *Haw. in Trans. Linn. Soc.* vii. 8; *Lodd. Bot. Cab.* t. 1430. Rosula foliorum 3-4-pollicaris 2-3 poll. diam., basi ramosa. Folia ovato-lanceolata multifaria vetustate rubro-brunnea 12-15 lin. longa 7-8 lin. lata 2-3 lin. crassa, facie læviuscula superiorum concava, inferiorum subplana, dorso rotundato tuberculis minutis crebris concoloribus scabrulo superne obliquo bicarinato. Pedunculus semipedalis vel pedalis simplex vel ramosus. Racemi laxi semipedales, pedicellis ascendentibus 1½-2 lin. longis, bracteis minutis lanceolatis. Perianthium 7-8 lin. longum rubro tinctum, segmentis quam tubus duplo brevioribus. *C. B. Spei*, circa 1795 introducta.

13. *H. NIGRA*, *Baker*.—*Apicra nigra*, *Haw. in Phil. Mag.* 1824, 302.—*Aloe nigra*, *Roem. et Schultes*, vii. 657; *Kunth, Enum.* iv. 495. Rosula foliorum semipedalis 3 poll. diam. Folia multifaria ovato-lanceolata vetustate nigrescentia 15-24 lin. longa 9-12 lin. lata 2-3 lin. crassa facie concava dorso rotundata superne oblique carinata apice subpungentia recurvata utrinque immaculata tuberculis parvis crebris concoloribus rugosa. Pedunculus simplex semipedalis. Racemus simplex laxus semipedalis, pedicellis ascendentibus 1-1½ lin. longis, bracteis minutis lanceolatis. Perianthium 8-9 lin. longum, segmentis quam tubus duplo brevioribus. *C. B. Spei*, a Bowie anno 1822 introducta.

14. *H. GLAUCA*, *Baker*. Rosula foliorum 2-3-pollicaris 1-1½ poll. diam. Folia multifaria omnia ascendente arcte imbricata lanceolata 6-9 lin. longa 3-4 lin. lata 2 lin. crassa pallide viridia facie plana dorso turgida superne regulariter carinata striis 5-7 verticalibus saturatoribus percurva utrinque lævia immaculata. Flores *Haworthiæ*, teste Cooper. *C. B. Spei*. V. v. in Hort. Kew. anno 1879.

15. *H. ATTENUATA*, *Haw. Syn.* 92.—*Aloe attenuata*, *Haw. in Trans. Linn. Soc.* vii. 11; *Salm-Dyck, Aloe*, sect. iv. fig. 12; *Kunth, Enum.* iv. 505.—*Apicra attenuata*, *Willd. in Berl. Mag.* v. 270.—*Aloe Radula*, *Bot. Mag.* t. 1345, non *Jacq.* Rosulæ foliorum cæspitosæ 4-5 poll. diam. Folia 30-40 lanceolato-deltaidea acuminata 2½-3 poll. longa basi 8-9 lin.

lata 2 lin. crassa facie plana tuberculis minutis scabra, dorso turgida, tuberculis margaritaceis magnitudine mediocribus transversaliter confluentibus regulariter seriatis prædita, superne carinata. Pedunculus subpedalis simplex vel ramosus. Racemus latus semipedalis, pedicellis erecto-patentibus 1-1½ lin. longis, bracteis minutis deltoideis cuspidatis. Perianthium 8-9 lin. longum, segmentis quam tubus duplo brevioribus. *C. B. Spei*, in hortis anglis ante annum 1790 culta.

Var. *H. CLARIPERLA*, *Haw. in Phil. Mag.* 1826, 186.—*Aloe attenuata*, var. *clariperla*, *Salm-Dyck, Aloe*, sect. vi. fig. 12 β, a typo recedit tuberculis margaritaceis paulo majoribus minus regulariter seriatis.

16. *H. FASCIATA*, *Haw. Revis.* 54.—*Aloe fasciata*, *Salm-Dyck, Hort. Dyck.* 326; *Monogr.* sect. vi. fig. 15; *Kunth, Enum.* iv. 506.—*Apicra fasciata*, *Willd. in Berl. Mag.* v. 270. Rosula foliorum 3 poll. longa et lata. Folia 40-60 densa multifaria ascendentia lanceolato-deltoidea 15-18 lin. longa basi 5-6 lin. lata 1½ lin. crassa facie glauco-viridia immaculata dorso turgida seriebus transversis 15-20 tuberculorum margaritaceorum emersorum regulariter seriatorum prædita superne carinata. Pedunculus subpedalis simplex vel ramosus. Racemus latus semipedalis, pedicellis erecto-patentibus 2-3 lin. longis, bracteis minutis deltoideo-cuspidatis. Perianthium 8-9 lin. longum rubro tinctum, segmentis quam tubus duplo brevioribus. *C. B. Spei*, in hortis anno circiter 1800 introducta. Var. *MAJOR*, *Salm-Dyck, Mon.* sect. vi. fig. 15 β, est forma ad *A. REINWARDTII* accedens, caule foliifero magis producto, foliis majoribus.

17. *H. SUBFASCIATA*, *Baker.*—*Aloe subfasciata*, *Salm-Dyck, Hort.* 325; *Aloe*, sect. vi. fig. 14; *Kunth, Enum.* iv. 505.—*Haworthia fasciata*, var. *major*, *Haw. Revis.* 54. Rosula foliorum 5-6 poll. longa. Folia 30-40 densa multifaria ascendentia lanceolato-deltoidea acuminata 3-4 poll. longa basi 1 poll. lata 3-4 lin. crassa facie subplana haud tuberculata dorso rotundata tuberculis margaritaceis magnitudine mediocribus transverse irregulariter seriatis prædita superne carinata. Pedunculus ramosus subpedalis. Racemi laxiflori 6-9 poll. longi, pedicellis ascendentibus 2-3 lin. longis, bracteis paucis lanceolatis. Perianthium 8-9 lin. longum, segmentis quam tubus duplo brevioribus. *C. B. Spei*, anno 1814 introducta.

18. *H. MARGARITIFERA*, *Haw. Suppl.* 55.—*Aloe pumila a. margaritifera*, *Linn. Sp. edit.* i. 322.—*A. margaritifera*, *Miller, Dict.* edit. vi. No. 14; *Soland. in Ait. Hort. Kew.* edit. 1, i. 468; *Salm-Dyck, Aloe*, sect. vi. fig. 5; *Kunth, Enum.* iv. 502.—*Haworthia major*, *Duval, Pl. Succ. Hort. Alanc.* 7; *Haw. Syn.* 92. Rosula foliorum 4-5 poll. longa et lata. Folia 30-40 densa ascendentia multifaria lanceolato-deltoidea 2½-3 poll. longa basi 12-15 lin. lata 3-4 lin. crassa facie turgida dorso rotundata superne carinata utrinque ubique tuberculis magnis (½-1 lin. latis) margaritaceis emersis irregulariter seriatis prædita. Pedunculus pedalis et ultra ramosus. Racemi semipedales, pedicellis brevissimis, bracteis deltoideo-cuspidatis.

Perianthium 6-7 lin. longum, segmentis quam tubus duplo brevioribus. *C. B. Spei.*

Var. H. *ERECTA*, *Haw. Revis.* 55.—*Aloe africana margaritifera minor Dill. Hort. Elth.* tab. 16. fig. 17.—*Aloe erecta, Salm-Dyck, Aloe*, sect. vi. fig. 7.—*Haworthia minor, Duval, Pl. Succ.* 7, a typo recedit foliis paulo minoribus, tuberculis margaritaceis paulo minoribus crebrioribus.

Var. H. *GRANATA*, *Haw. Suppl.* 57.—*Aloe africana margaritifera minima, Dill. Hort. Elth.* tab. 16. fig. 18.—*A. granata, Salm-Dyck, Aloe*, sect. vi. fig. 6.—*Apicra granata, Willd. in Berl. Mag.* v. 269.—*Aloe margaritifera*, var. *minima, Bot. Mag.* tab. 1360.—*Haworthia brevis, Haw. Suppl.* 57. Minor, rosulis 3-4 poll. diam., foliis magis deltoideis $1\frac{1}{2}$ -2 poll. longis, tuberculis margaritaceis minoribus crebrioribus.

Var. H. *SEMIMARGARITIFERA*, *Haw. Suppl.* 53.—*Aloe semimargaritifera, Salm-Dyck, Cat.* 6; *Kunth, Enum.* iv. 501.—*Haworthia maxima, Duval, Pl. Succ.* 7.—*Aloe subalbicans, Salm-Dyck, Aloe*, sect. vi. fig. 1. Statura formæ typicalis, foliis acuminatis 3-4 poll. longis, tuberculis magnis ad dorsum versus apicem et basin paucioribus magis distantibus, ad faciem superiorem paucis carinalibus vel subnullis, carina dorsali magis prominente.

Var. H. *CORALLINA, Hort. Peacock.* Folia 2-2½ poll. longa, facie parce tuberculata tuberculis reductis sæpe viridulis scabra, dorso tuberculis emersis margaritaceis magnitudine mediocribus obscure transverse seriatis ubique prædita. *V. v. in hort. Peacock.*

19. H. *SEMIGLABRATA, Haw. Suppl.* 55.—*Aloe semiglabrata, Salm-Dyck, Hort.* 321; *Aloe*, sect. vi. fig. 2; *Kunth, Enum.* iv. 500. Rosula foliorum $3\frac{1}{2}$ -4 poll. longa et lata. Folia 30-40 ascendentia multifaria lanceolato-deltoidea acuminata 3-3½ poll. longa basi 9-12 lin. lata 3-4 lin. crassa facie plana lævia vel versus apicem parce tuberculata dorso rotundata superne carinata medio tuberculis multis margaritaceis emersis magnitudine mediocribus obscure seriatis prædita, tuberculis versus apicem et basin paucis sparsis. Scapus pedalis et ultra ramosus. Racemus semipedalis, pedicellis brevissimis, bracteis parvis deltoideo-cuspidatis. Perianthium 6-7 lin. longum, segmentis quam tubus duplo brevioribus. *C. B. Spei*, in hortis ante annum 1811 culta. A *H. margaritifera*, var. δ , arcte accedens.

20. H. *SUBATTENUATA, Baker.*—*Aloe subattenuata, Salm-Dyck, Hort.* 324; *Aloe*, sect. vi. fig. 11; *Kunth, Enum.* iv. 504.—*Haworthia Radula*, var. *magniperlata, Haw. Revis.* 54. Rosula foliorum 4-5 poll. longa et lata. Folia 40-50 densa multifaria lanceolato-deltoidea acuminata 2-3 poll. longa basi 8-9 lin. lata 2-3 lin. crassa facie plana lævia vel parce tuberculata dorso rotundata tuberculis crebris emersis margaritaceis haud seriatis $\frac{1}{4}$ - $\frac{1}{2}$ lin. diam. ubique decorata. Pedunculus pedalis sæpissime ramosus. Racemus semipedalis, pedicellis brevissimis, bracteis minutis lanceolatis. Perianthium 7-8 lin. longum, segmentis quam tubus duplo brevioribus. *C. B. Spei*, in anno circiter 1814 introducta.

21. *H. GLABRATA*, *Baker*.—*Aloe glabrata*, *Salm-Dyck*, *Hort.* 325; *Aloe*, sect. vi. fig. 13; *Kunth*, *Enum.* iv. 505. Rosula foliorum 5–6 poll. longa et lata. Folia 30–40 densa multifaria lanceolato-deltoidea acuminata 4–5 poll. longa basi 1 poll. lata 3–4 lin. crassa facie plana glauco-viridia immaculata lævia dorso rotundata superne distincte carinata ubique tuberculis parvis margaritaceis emersis distantibus haud seriatis prædita. Pedunculus pedalis et ultra ramosus. Racemus semipedalis, pedicellis 1–2 lin. longis, bracteis lanceolatis vel deltoideis. Perianthium 7–8 lin. longum rubro tinctum, segmentis quam tubus duplo brevioribus. *C. B. Spei*, ante annum 1834 introducta.

Var. *PERVIRIDIS*, *Salm-Dyck*, *Aloe*, sect. vi. fig. 13 β . Folia viridia tuberculis dorsalibus multo crebrioribus albo-viridibus.

Var. *CONCOLOR*, *Salm-Dyck*, *Aloe*, sect. vi. fig. 13 γ , est forma insignis, verisimiliter hybrida hortensis (inter *glabratam* et *rigidam*?), in hort. Kew. orta foliis iis plantæ typicæ conformibus sed ubique tuberculis minutis concoloribus rugosis.

22. *H. SUBULATA*, *Baker*.—*Aloe subulata*, *Salm-Dyck*, *Hort.* 324; *Aloe*, sect. vi. fig. 10; *Kunth*, *Enum.* iv. 504.—*H. Radula*, var. lævior, *Haw. Revis.* 54. Rosula foliorum 5–6 poll. longa et lata. Folia 30–40 densa multifaria lanceolato-deltoidea valde acuminata 3–4 poll. longa basi 10–12 lin. lata 3 lin. crassa facie subplana rugosula obscure tuberculata dorso rotundata superne carinata tuberculis minutis emersis albidis scabra. Pedunculus ramosus pedalis vel sesquipedalis. Racemi laxi semipedales, pedicellis 2–3 lin. longis, bracteis minutis lanceolatis. Perianthium 8–9 lin. longum, segmentis quam tubus duplo brevioribus. *C. B. Spei*, versus annum 1814 introducta.

23. *H. RADULA*, *Haw. Syn.* 93.—*Aloe Radula*, *Jacq. Hort. Schoen.* iv. 11, t. 422; *Salm-Dyck*, *Aloe*, sect. vi. fig. 8; *Kunth*, *Enum.* iv. 504.—*Apicra Radula*, *Willd. in Berl. Mag.* v. 270. Rosula foliorum 5–6 poll. longa et lata. Folia 30–40 densa multifaria lanceolato-deltoidea valde acuminata $2\frac{1}{2}$ –3 poll. longa basi 8–9 lin. lata 2–3 lin. crassa facie subplana dorso rotundata superne carinata ubique utrinque tuberculis minutis creberrimis albidis scabra. Pedunculus subpedalis simplex vel ramosus. Racemus laxus semipedalis, pedicellis ascendentibus 1–2 lin. longis, bracteis minutis lanceolatis. Perianthium 8–9 lin. longum, segmentis quam tubus duplo brevioribus. *C. B. Spei*, versus annum 1800 introducta.

24. *H. RUGOSA*, *Baker*.—*Aloe rugosa*, *Salm-Dyck*, *Hort.* 223; *Aloe*, sect. vi. fig. 9; *Kunth*, *Enum.* iv. 504.—*H. Radula*, var. asperior, *Haw. Revis.* 54. Rosula foliorum 5–6 poll. longa et lata. Folia 30–50 densa multifaria lanceolato-deltoidea valde acuminata 3–4 poll. longa basi 9–12 lin. lata 3 lin. crassa facie subplana dorso rotundata superne carinata utrinque ubique tuberculis parvis sed majoribus quam ea *H. Radulæ* albidis scaberrima. Pedunculus sesquipedalis ramosus. Racemi laxi semipedales, pedicellis brevissimis erecto-patentibus, bracteis parvis lanceolatis. Peri-

anthium 6-7 lin. longum, segmentis quam tubus duplo brevioribus. *C. B. Spei*, anno circiter 1814 introducta.

25. *H. ALBICANS*, *Haw. Syn.* 91.—*Aloe albicans*, *Haw. in Trans. Linn. Soc.* vii. 8; *Bot. Mag.* tab. 1452; *Salm-Dyck, Aloe*, sect. v. fig. 1; *Kunth, Enum.* iv. 500.—*Apicra albicans*, *Willd. in Berl. Mag.* v. 271.—*Aloe africana humilis*, etc., *Commel. Præhud.* t. 30, *Rar.* t. 48.—*A. marginata*, *Lam. Encyc.* i. 89.—*H. lævis*, *Haw. Revis.* 52.—*Aloe lævigata*, *Roem. et Schultes, Syst.* vii. 636. Rosula foliorum 4-5 poll. longa et lata. Folia circiter 30 densa multifaria lanceolato-deltaidea $2\frac{1}{2}$ -3 poll. longa 15-18 lin. lata basi 3-4 lin. crassa facie leviter concava dorso rotundata superne distincte carinata firma ubique lævissima nitidula marginibus carinaque albido-cartilagineis. Pedunculus validus pedalis sæpe ramosus. Racemus strictus semipedalis, pedicellis erecto-patentibus 1-2 lin. longis, bracteis parvis lanceolatis. Perianthium 7-8 lin. longum, segmentis quam tubus duplo brevioribus. *C. B. Spei*, circiter annum 1700 introducta. *H. RAMIFERA*, *Haw. Revis.* 52, est forma mera caule inferne ramuloso. *H. VIRESCENS*, *Haw. Revis.* 52, est forma foliis dorso præter carinam tuberculis emersis magnis paucis albicantibus præditis.

26. *H. SCABRA*, *Haw. Suppl.* 58; *Revis.* 51.—*Aloe scabra*, *Roem. et Schultes, Syst.* vii. 644; *Salm-Dyck, Mon.* sect. vii. fig. 1; *Kunth, Enum.* iv. 507. Rosula foliorum 2 poll. longa et lata. Folia 10-12 multifaria ascendentia lanceolato-deltaidea $1\frac{1}{2}$ -2 poll. longa basi 8-12 lin. lata 3-4 lin. crassa facie plana vel subconcava dorso rotundata superne oblique carinata firma saturate viridia immaculata ubique tuberculis emersis minutis concoloribus scabra. Pedunculus gracilis simplex subpedalis. Racemus laxus semipedalis, pedicellis brevissimis, bracteis minutis lanceolatis. Perianthium 7-8 lin. longum, segmentis quam tubus duplo brevioribus. *C. B. Spei*, anno 1818 introducta.

27. *H. SORDIDA*, *Haw. Revis.* 51.—*Aloe sordida*, *Roem. et Schultes, Syst. Veg.* vii. 644; *Salm-Dyck, Aloe*, sect. vii. fig. 2; *Kunth, Enum.* iv. 507. Rosula foliorum 4-4 $\frac{1}{2}$ poll. longa et lata. Folia 10-12 multifaria ascendentia lanceolato-deltaidea 3-4 poll. longa basi 12-15 lin. lata 3-4 lin. crassa facie leviter concava dorso rotundata superne carinata rigida luride viridia subtus scabriuscula. Pedunculus gracilis simplex subpedalis. Racemus laxus semipedalis, pedicellis brevissimis, bracteis minutis. Perianthium 8-9 lin. longum, segmentis quam tubus duplo brevioribus. *C. B. Spei*.

28. *H. ICOSIPHYLLA*, *Baker*. Rosula foliorum 2 poll. longa 3 poll. diam. Folia circiter 20 lanceolato-deltaidea multifaria 15-18 lin. longa basi 8-9 lin. lata medio $1\frac{1}{2}$ lin. crassa purpureo-viridia leviter recurvata apice subpungentia facie concava dorso rotundata superne carinata ubique papillis minutis concoloribus scabra. Pedunculus simplex semipedalis. Racemus debilis pedalis, pedicellis 1-1 $\frac{1}{2}$ lin. longis, bracteis parvis delta-

deis. Perianthium 8-9 lin. longum, segmentis quam tubus duplo brevioribus. *C. B. Spei*. V. v. in Hort. Kew. anno 1872.

29. *H. TISLEYI*, *Baker*. Rosula foliorum 2½-3 poll. longa et lata. Folia 30-40 densa multifaria deltoideo-cuspidata 12-15 lin. longa basi 7-8 lin. lata 2-3 lin. crassa firma atroviridia immaculata facie subplana dorso rotundata superne obscure oblique carinata ubique papillis minutis concoloribus creberrimis scabra. Flores non vidi. *C. B. Spei*. V. v. in Hort. Kew. 1879. Ad *H. subulatæ* var. *concolorem* arcte accedit.

30. *H. RECURVA*, *Haw. Synop.* 94; *Revis.* 51.—*Aloe recurva*, *Haw. in Trans. Linn. Soc.* vii. 60; *Bot. Mag.* t. 1353; *Salm-Dyck, Aloe*, sect. vii. fig. 3; *Kunth, Enum.* iv. 507.—*Apicra recurva*, *Willd. in Berl. Mag.* v. 270. Rosulæ foliorum cæspitosæ 2-3 poll. longæ et latæ. Folia 12-15 multifaria deltoidea valde recurvata 12-15 lin. longa basi 8-9 lin. lata 3-4 lin. crassa facie haud excavata pallide viridia lineis saturatoribus verticalibus percursa dorso rotundata superne carinata olivaceo-viridia papillis concoloribus crebris scabra. Pedunculus simplex gracilis semipedalis. Racemus latus pauciflorus, pedicellis 2-3 lin. longis, bracteis minutis. Perianthium 8-9 lin. longum, segmentis quam tubus duplo brevioribus. *C. B. Spei*, a Masson anno 1795 introducta. A *Recurvis* reliquis recedit foliis firmioribus dorso scabris.

31. *HASPERULA*, *Haw. in Phil. Mag.* 1824, 300.—*Aloe asperula*, *Roem. et Schultes, Syst.* vii. 635; *Salm-Dyck, Aloe*, sect. ix. fig. 2; *Kunth, Enum.* iv. 508. Rosula foliorum 1 poll. longa 2½-3 poll. diam. Folia 10-12 multifaria patentia oblonga acuta 1-1½ poll. longa 8-9 lin. lata medio 5-6 lin. crassa utrinque pallide viridia facie turgida superne cito recurvata papillis minutis concoloribus scabra lineis 7-9 pallidioribus verticalibus percursa dorso lævia concoloria triquetra ad margines carinamque obsolete denticulata. Pedunculus gracilis simplex subpedalis. Racemus latus semipedalis, pedicellis brevissimis, bracteis lanceolato-deltoideis. Perianthium 7-8 lin. longum rubro tinctum, segmentis quam tubus duplo brevioribus. *C. B. Spei*, circiter annum 1823 introducta. Habitus omnino *H. retusæ*.

32. *H. RETUSA*, *Haw. Syn.* 95.—*Aloe retusa*, *Linn. Sp.* 459; *DC. Plantes Grasses*, t. 45; *Haw. in Trans. Linn. Soc.* vii. 9; *Bot. Mag.* t. 455; *Salm-Dyck, Aloe*, sect. ix. fig. 3; *Kunth, Enum.* iv. 509.—*Apicra retusa*, *Willd. in Berl. Mag.* v. 271.—*Aloe africana* etc., *Commel. Hort.* ii. t. 6.—*Catevala retusa*, *Medic. Theod.* 68. Rosula foliorum 1 poll. longa 2-3 poll. diam. Folia 10-15 multifaria patentia oblonga acuta 1-1½ poll. longa 8-9 lin. lata medio 5-6 lin. crassa facie turgida lævia læte viridia sursum abrupte recurvata striis pallidis 5-7 verticalibus percursa dorso concoloria lævia triquetra margine integerrima, apice cuspidato. Pedunculus simplex subpedalis. Racemus latus semipedalis, pedicellis brevis-

simis, bracteis lanceolatis 2-3 lin. longis. Perianthium 8-9 lin. longum, segmentis quam tubus duplo brevioribus. *C. B. Spei*, ante annum 1700 introducta. *H. MUTICA*, *Haw. Revis.* 55, est forma foliis haud cuspidatis.

33. *H. TURGIDA*, *Haw. Suppl.* 22.—*Aloe turgida*, *Roem. et Schultes, Syst.* vii. 635; *Salm-Dyck, Aloe*, sect. ix. fig. 5; *Kunth, Enum.* iv. 509. Rosulæ foliorum cæspitosæ 2-2½ poll. latæ 1 poll. longæ. Folia 20-30 densissima multifaria patentia oblongo-lanceolata integra cuspidata pallide viridia vetustate rubescentia 9-12 lin. longa medio 3-4 lin. lata 3 lin. crassa utrinque lævia facie turgida recurvata apice pellucida lineis 3-5 verticalibus viridibus percursa margine integra dorso carinata. Pedunculus simplex semipedalis. Racemus semipedalis, pedicellis brevissimis, bracteis parvis lanceolato-deltaideis. Perianthium 8-9 lin. longum, segmentis quam tubus paulo brevioribus. *C. B. Spei*, anno 1818 a Bowie introducta.

34. *H. CUSPIDATA*, *Haw. Suppl.* 51, *Revis.* 58.—*Aloe cuspidata*, *Roem. et Schultes, Syst.* vii. 639; *Kunth, Enum.* iv. 510. Rosula foliorum 1-1½ poll. longa 2-2½ poll. diam. Folia 20-30 densa multifaria obovato-cuneata 1 poll. longa 9-10 lin. lata medio 3-4 lin. crassa pallide viridia facie plana sursum recurvata aquoso-pellucida lineis viridibus anastomosantibus percursa apice cuspidata dorso rotundata lævia sursum carinata. Pedunculus simplex 8-10-pollicaris. Racemus laxus semipedalis, pedicellis inferioribus 1½-2 lin. longis, bracteis deltaideo-cuspidatis 2-3 lin. longis. Perianthium 6-7 lin. longum, segmentis quam tubus paulo brevioribus. *C. B. Spei*, anno 1818 a Bowie introducta. Inter *H. retusam* et *cymbifoliam* medium tenens.

35. *H. CYMBIFORMIS*, *Haw. Syn.* 93.—*H. concava*, *Haw. Revis.* 98; *Aloe cymbiformis*. *Haw. in Trans. Linn. Soc.* vii. 8; *Bot. Mag.* t. 802.—*A. cymbæfolia*, *Schrad. Neues Journ.* ii. 17, t. 2; *Jacq. Fragm.* t. 112. fig. 1; *Salm-Dyck, Aloe*, sect. xi. fig. 1; *Kunth, Enum.* iv. 511.—*Apicra cymbæfolia*, *Willd. in Berl. Mag.* v. 271. Rosula foliorum 1½-2 poll. longa 3-4 poll. diam. Folia 20-25 obovata acuta 1-1½ poll. longa 9-10 lin. lata medio 2-2½ lin. crassa pallide viridia facie leviter concava superne lineis multis viridibus anastomosantibus percursa apice setaceo-aristata ubique lævia dorso rotundata sursum carinata. Pedunculus simplex subpedalis. Racemus laxus semipedalis, pedicellis 2-3 lin. longis, bracteis lanceolatis. Perianthium 7-8 lin. longum, segmentis tubo vix brevioribus. *C. B. Spei*, anno 1795 a Masson introducta. *Somerset*, Bowker!

Var. *H. OBTUSA*, *Haw. in Phil. Mag.* 1825, 282.—*Aloe hebes*, *Roem. et Schultes, Syst.* vii. 637; *Kunth, Enum.* iv. 511. Minor, foliis 1 poll. longis colore saturatoribus apice crassioribus magis distincte striatis.

Var. *H. PLANIFOLIA*, *Haw. in Phil. Mag.* 1825, 282.—*Aloe planifolia*, *Roem. et Schultes, Syst.* vii. 638; *Salm-Dyck, Aloe*, sect. xi. fig. 2. Folia medio 3 lin. crassa facie subplana.

6. *H. ALTILINEA*, *Haw. in Phil. Mag.* 1824, 301.—*Aloe altilinea*,

Roem. et Schultes, Syst. vii. 638; *Salm-Dyck, Aloe*, sect. xi. fig. 3; *Kunth, Enum.* iv. 512.—*H. mucronata*, limpida et aristata, *Haw. Suppl.* 50–51. Rosula foliorum 2 poll. longa 3–4 poll. diam. Folia circiter 30 densa multifaria ascendentia oblanceolato-obovata acuta longe setaceo-aristata $1\frac{1}{2}$ –2 poll. longa supra medium 8–9 lin. lata 2 lin. crassa pallide viridia facie plana dorso turgida superne carinata ubique lævia sursum aquoso-pellucida utrinque lineis 5–7 viridibus verticalibus haud anastomosantibus percursa. Pedunculus simplex gracilis 6–9-pollicaris. Racemus latus semipedalis, pedicellis brevissimis, bracteis lanceolato-deltoidis. Perianthium album 6–7 lin. longum, segmentis quam tubus duplo brevioribus. *C. B. Spei*, circiter annum 1818 introducta. *Uitenhage*, Zeyher 1053!

37. *H. RETICULATA*, *Haw. Syn.* 94; *Revis.* 57.—*Aloe reticulata*, *Haw. in Trans. Linn. Soc.* vii. 9; *Lodd. Bot. Cab.* t. 1354; *Salm-Dyck, Aloe*, sect. x. fig. 1; *Kunth, Enum.* iv. 510.—*Apicra reticulata*, *Willd. in Berl. Mag.* v. 272.—*Aloe pumilio*, *Jacq. Hort. Schoen.* t. 421.—*A. herbacea*, *DC. Hort. Monspel.* 76.—*A. arachnoides*, var. *reticulata*, *Bot. Mag.* t. 1314. Rosulæ foliorum cæspitosæ $1\frac{1}{2}$ poll. longæ 2–2 $\frac{1}{2}$ poll. diam. Folia 30–40 densa multifaria oblongo-lanceolata acuta pallide viridia 12–15 lin. longa 4–5 lin. lata $1\frac{1}{2}$ lin. crassa facie turgida superne lineolis viridulis anastomosantibus percursa dorso rotundata superne carinata margine obsolete denticulata. Pedunculus gracilis simplex semipedalis. Racemus latus pauciflorus semipedalis, pedicellis $1\frac{1}{2}$ –2 lin. longis, bracteis lanceolatis. Perianthium 8–9 lin. longum, segmentis quam tubus duplo brevioribus. *C. B. Spei*, ante annum 1794 introducta.

38. *H. ANGOLENSIS*, *Baker in Trans. Linn. Soc.* ser. 2, *Bot.* i. 263. Bulbus squamis ovato-lanceolatis dense imbricatis. Rosula foliorum 3–4 poll. diam. Folia 10–12 multifaria ascendentia linearia 2–3 poll. longa facie planiuscula marginibus dentibus minutis retrorsis armata. Pedunculus simplex semipedalis. Racemus latus 4–5-pollicaris, pedicellis brevissimis, bracteis deltoideo-cuspidatis 2–3 lin. longis. Perianthium 6 lin. longum, segmentis quam tubus duplo brevioribus. *Angola in dumetis arenosis regionis subtemperatæ ditionis Huilla*, Welwitsch!

39. *H. ANGUSTIFOLIA*, *Haw. in Phil. Mag.* 1825, 283.—*Aloe stenophylla*, *Roem. et Schultes, Syst.* vii. 641; *Salm-Dyck, Aloe*, sect. xiii. fig. 2; *Kunth, Enum.* iv. 514. Rosula foliorum $1\frac{1}{2}$ poll. longa 3 poll. diam. Folia circiter 20 ascendentia multifaria lanceolata valde acuminata $1\frac{1}{2}$ –2 poll. longa 3–4 lin. lata $1\frac{1}{2}$ lin. crassa utrinque læte viridia vetustate rubescentia immaculata haud lineata facie plana dorso convexa sursum 1–3-carinata apice cuspidata, marginibus carinaque minute ciliatis. Pedunculus gracillimus simplex semipedalis. Racemus latus pauciflorus, pedicellis brevissimis, bracteis deltoideo-cuspidatis. Perianthium 8–9 lin. longum, segmentis tubo vix brevioribus. *C. B. Spei*, anno 1824 a Bowie introducta.

40. *H. CHLOROCANTHA*, *Haw. Revis.* 57.—*Aloe chlorocantha*, *Roem. et Schultes, Syst.* vii. 641; *Salm-Dyck, Aloe*, sect. xiii. fig. 1; *Kunth, Enum.* iv. 514. Rosula foliorum 2 poll. longa et lata. Folia 20–30 multifaria lanceolato-deltaïdeia rigida obscure viridia 12–18 lin. longa basi 6–8 lin. lata $1\frac{1}{2}$ lin. crassa utrinque immaculata haud lineata facie lævia leviter concava dorso rotundata scabra superne carinata apice cuspidata, marginibus carinaque dentibus crebris minutis lanceolatis deflexis præditis. Scapus gracilis simplex semipedalis. Racemus brevis latus pauciflorus, pedicellis brevissimis, bracteis lanceolato-deltaïdeis. Perianthium 7–8 lin. longum rubro tinctum, segmentis quam tubus duplo brevioribus. *C. B. Spei*, in anno 1819 a Bowie introducta.

41. *H. TESSELLATA*, *Haw. in Phil. Mag.* 1824, 300.—*Aloe tessellata*, *Roem. et Schultes, Syst.* vii. 635; *Salm-Dyck, Aloe*, sect. viii. fig. 1; *Kunth, Enum.* iv. 508. Rosula foliorum 2 poll. longa $2\frac{1}{2}$ –3 poll. diam. Folia 12–15 multifaria deltaïdeia recurvato-potentia 15–18 lin. longa 9–12 lin. lata 3–4 lin. crassa coriacea facie plana obscure viridia lineis 5–7 pallidis verticalibus lineis transversalibus connexis tessellata dorso rotundata obscure viridia immaculata papillis parvis concoloribus scabra, apice subpungente, marginibus elevatis dentibus distinctis retrorsis armatis. Pedunculus gracilis simplex semipedalis et ultra. Racemus latus pauciflorus, pedicellis 1–2 lin. longis, bracteis minutis deltaïdeis. Perianthium 8–9 lin. longum, segmentis quam tubus duplo brevioribus. *C. B. Spei*, in anno 1822 introducta.

Var. *H. PARVA*, *Haw. in Phil. Mag.* 1824, 301.—*Aloe parva*, *Roem. et Schultes, Syst.* vii. 653; *Salm-Dyck, Aloe*, sect. viii. fig. 2. Rosula foliorum $1\frac{1}{2}$ poll. longa 2 poll. diam. Folia perfecte deltaïdeia 12–15 lin. longa et lata. *C. B. Spei*, a Bowie introducta.

Var. *INFLEXA*, *Baker*. Rosula foliorum 2–3 poll. longa 2 poll. diam. Folia deltaïdeia purpureo-viridia facie concava, inferiora marginibus prominulis inflexis. *C. B. Spei*. V. v. in *Hort. Kew.* anno 1879.

42. *H. VENOSA*, *Haw. Revis.* 44.—*Aloe africana humilis*, etc. *Commel. Præhud.* t. 29.—*Aloe venosa*, *Lam. Encyc.* i. 89; *Kunth, Enum.* iv. 514.—*Aloe tricolor*, *Haw. in Trans. Linn. Soc.* vii. 25.—*Apicra tricolor*, *Willd. in Berl. Mag.* v. 271.—*Haworthia distincta*, *N. E. Brown in Gard. Chron.* 1876, ii. 130, fig. 30. Rosula foliorum $1\frac{1}{2}$ poll. longa $3\frac{1}{2}$ – $4\frac{1}{2}$ poll. diam. Folia 12–15 multifaria recurvato-potentia lanceolato-deltaïdeia 3 poll. longa basi 7–8 lin. lata $2\frac{1}{2}$ – $3\frac{1}{2}$ lin. crassa ubique coriacea facie obscure viridia purpureo tincta lineis 5 pallidis verticalibus lineis transversalibus connexis percursa dorso rotundata superne rugosa apice subpungentia, marginibus denticulatis. Pedunculus simplex semipedalis. Racemus latus 6–9-pollicaris, pedicellis 1– $1\frac{1}{2}$ lin. longis, bracteis parvis deltaïdeio-cuspidatis. Perianthium 7 lin. longum, segmentis quam tubus duplo brevioribus. *C. B. Spei*. V. v. in *Hort. Kew.* anno 1876, a Bolus missa.

43. *H. MIRABILIS*, *Haw. Syn.* 95.—*Aloe mirabilis*, *Haw. in Trans. Linn. Soc.* vii. 9; *Bot. Mag.* t. 1354; *Salm-Dyck, Aloe*, sect. ix. fig. 1; *Kunth, Enum.* iv. 508.—*Apicra mirabilis*, *Willd. in Berl. Mag.* v. 269. Rosula foliorum 2 poll. longa et lata. Folia 15–20 multifaria deltoidea coriacea 12–15 lin. longa 9–10 lin. lata medio 5–6 lin. crassa facie plana cite recurvata lævia viridia lineis 3–5 pallidioribus percursa dorso obscure viridia rotundata scabra, marginibus carinaque denticulatis. Pedunculus simplex gracilis semipedalis et ultra. Racemus laxis pauciflorus, pedicellis 2–3 lin. longis, bracteis lanceolatis. Perianthium 7–8 lin. longum, segmentis quam tubus duplo brevioribus. *C. B. Spei*, ad annum 1795 a Masson introducta. Ab *Denticulatis* reliquis recedit foliis crassis deltoideis facie more *H. retusæ* valde recurvatis. *H. MULTIFARIA*, *Haw. in Phil. Mag.* 1824, 300, ex descriptione non possum segregare.

44. *H. SUBREGULARIS*, *Baker in Saund. Ref. Bot.* t. 232. Rosula foliorum 1 poll. longa $2\frac{1}{2}$ –3 poll. diam. Folia 20–30 multifaria ovata acuta 15–18 lin. longa 7–8 lin. lata 3 lin. crassa glauco-viridia facie subplana dorso convexa prorsus regulariter carinata utrinque dimidio superiore multilineata et tuberculis albidis parvis prædita apice haud aristata margine minute denticulata. Pedunculus simplex semipedalis. Racemus laxis 6–9 pollicaris, pedicellis $1\frac{1}{2}$ –2 lin. longis, bracteis lanceolatis pedicello longioribus. Perianthium 8–9 lin. longum, segmentis ligulatis subregulariter falcatis. *C. B. Spei*, anno 1860 a Cooper introducta.

45. *H. ATROVIRENS*, *Haw. Revis.* 57.—*H. pumila*, *Haw. Syn.* 95.—*Aloe atrovirens*, *DC. Plantes Grasses*, t. 51; *Salm-Dyck, Aloe*, sect. x. fig. 2; *Kunth, Enum.* iv. 510.—*A. pumila* ϵ , *Linn. Sp.* 460.—*A. herbacea*, *Miller, Dict.* edit. vi. No. 18.—*A. arachnoides*, var. *pumila*, *Willd. Sp.* ii. 188; *Bot. Mag.* t. 1361.—*Catevala atroviridis*, *Medic. Theod.* 69.—*Apicra atrovirens*, *Willd. in Berl. Mag.* v. 268. Rosula foliorum 1 poll. longa, 2 poll. diam. Folia 30–40 densa multifaria oblongo-lanceolata 6–8 lin. longa 4–5 lin. lata $1\frac{1}{2}$ lin. crassa atroviridia facie turgida apice aquosopellucida lineis 3–5 viridibus anastomosantibus percursa dorso rotundata superne carinata apice cuspidata, marginibus carinaque dentibus minutis deltoideo-cuspidatis armatis. Pedunculus simplex gracilis semipedalis. Racemus laxis pauciflorus, pedicellis brevissimis, bracteis lanceolatis. Perianthium 7–8 lin. longum, segmentis quam tubus duplo brevioribus. *C. B. Spei*, in hortis europæis a temporibus remotis culta.

46. *H. LÆTEVIRENS*, *Haw. Suppl.* 43.—*Aloe lætevirens*, *Link, Enum.* i. 335; *Salm-Dyck, Aloe*, sect. x. fig. 3; *Kunth, Enum.* iv. 511. Rosula foliorum 1 poll. longa 2–3 poll. diam. Folia 20–30 densa multifaria oblongo-lanceolata acuta 1 – $1\frac{1}{2}$ poll. longa medio 4–5 lin. lata 1 – $1\frac{1}{2}$ lin. crassa obscure pallide viridia vetustate rubescentia facie subplana sursum obscure lineolata apice pellucido-aristata dorso turgida superne carinata,

marginibus carinaque distincte denticulatis. Pedunculus gracilis simplex semipedalis. Racemus laxus pauciflorus, pedicellis 1-1½ lin. longis, bracteis lanceolatis. Perianthium 8-9 lin. longum, segmentis quam tubus duplo brevioribus. *C. B. Spei*, a Bowie anno 1818 introducta.

47. *H. DENTICULATA*, *Haw. Revis.* 58.—*Aloe denticulata*, *Roem. et Schultes, Syst.* vii. 639.—*A. altilinea* var. *denticulata*, *Salm-Dyck, Aloe*, sect. xi. fig. 3, β; *Kunth, Enum.* iv. 512. Rosula foliorum 1½-2 poll. longa 3-4 poll. diam. Folia 20-30 densa multifaria oblongo-lanceolata acuta basi cuneata 15-18 lin. longa medio 6-9 lin. lata 2-3 lin. crassa pallide viridia facie turgidula superne aquoso-pellucida lineis 5-7 viridibus haud reticulatis percursa apice pellucido-aristata dorso rotundata superne 1-2-carinata, marginibus carinaque dentibus albidis deltoideis superioribus patentibus inferioribus deflexis armatis. Pedunculus simplex semipedalis. Racemus laxus semipedalis, pedicellis brevissimis, bracteis lanceolato-deltoideis. Perianthium 7-8 lin. longum, segmentis tubo vix brevioribus. *C. B. Spei*, anno 1818 a Mackrell introducta. Habitus omnino *H. altilineæ*; solum recedit foliis marginibus carinaque ciliatis.

48. *H. BILINEATA*, *Baker*. Rosula foliorum 18-21 lin. longa 3 poll. diam. Folia 14-15 oblongo-lanceolata acuta 1½-2 poll. longa 6 lin. lata 4 lin. crassa obscure viridia facie subplana triente superiore aquoso-pellucida lineis 1-2 viridibus deorsum percursa apice haud aristata dorso rotundata superne carinata, marginibus carinaque ciliato-denticulatis. Pedunculus simplex 8-9-pollicaris. Racemus 5-6-florus semipedalis, pedicellis 1-1½ lin. longis, bracteis lanceolatis. Perianthium 7-8 lin. longum, segmentis rubro-vittatis tubo vix brevioribus. *C. B. Spei*, anno 1875 a MacGibbon introducta.

49. *H. AFFINIS*, *Baker*. Rosula foliorum 1 poll. longa 2-2½ poll. diam. Folia 18-20 multifaria oblongo-lanceolata acuta 1 poll. longa medio 6 lin. lata 4-4½ lin. crassa obscure viridia facie plana superne recurvata aquoso-pellucida lineis 1-2 viridibus brevibus percursa apice haud aristata dorso rotundata superne carinata, marginibus carinaque dentibus minutis armatis. Pedunculus simplex 6-9-pollicaris. Racemus 2-3-pollicaris 4-6-florus, pedicellis erecto-patentibus 1-1½ lin. longis, bracteis lanceolatis. Perianthium 7-8 lin. longum, segmentis tubo vix brevioribus. *C. B. Spei*, in anno 1875 a MacGibbon introducta. An sit varietas minor *H. bilineatæ*?

50. *H. POLYPHYLLA*, *Baker*. Rosula foliorum 2-2½ poll. longa 3-3½ poll. diam. Folia 40-50 densa multifaria oblongo-lanceolata acuta 1½ poll. longa 5-6 lin. lata 2-2½ lin. crassa viridia facie plana superne pallidiora lineis 7-9 crebris obscuris saturatoribus percursa apice acuminata dorso rotundata superne 1-3-carinata, marginibus carinisque aculeis crebris lanceolatis retrorsis albidis ½ lin. longis armatis. Pedunculus simplex

subpedalis. Racemus 12-15-pollicaris, pedicellis inferioribus $1\frac{1}{2}$ -2 lin. longis, bracteis lanceolatis. Perianthium 8-9 lin. longum rubro tinctum, segmentis tubo brevioribus. *C. B. Spei*, a Cooper anno 1860 introducta.

51. *H. VITTATA*, *Baker in Saund. Ref. Bot.* t. 263. Rosula foliorum $1\frac{1}{2}$ poll. longa 3-3 $\frac{1}{2}$ poll. diam. Folia 20-30 oblongo-lanceolata 18-21 lin. longa 6-7 lin. lata 3 lin. crassa pallide viridia utrinque sursum limpida lineis 3-5 viridibus haud anastomosantibus notata facie planiuscula dorso rotundata superne carinata apice pellucido-aristata, marginibus carinaque minute denticulatis. Pedunculus strictus simplex subpedalis. Racemus semipedalis, pedicellis brevissimis, bracteis lanceolatis. Perianthium 8-9 lin. longum, segmentis quam tubus duplo brevioribus. *C. B. Spei*, anno 1860 a Cooper introducta.

52. *H. TRANSLUCENS*, *Haw. Suppl.* 52.—*Aloe translucens*, *Soland. in Ait. Hort. Kew.* edit. ii. 2, 300; *Salm-Dyck, Aloe*, sect. xii. fig. 1.—*A. arachnoides*, var. *translucens*, *Bot. Mag.* t. 1417.—*Apicra translucens*, *Willd. in Berl. Mag.* v. 268.—*H. pellucens*, *Haw. Syn.* 96.—*Aloe pellucens*, *Haw. in Trans. Linn. Soc.* vii. 10. Rosula $1\frac{1}{2}$ poll. longa 2 $\frac{1}{2}$ -3 poll. diam. Folia 30-40 densa multifaria ascendentia albido-viridia sæpe purpureo tincta lanceolata $1\frac{1}{2}$ -2 poll. longa, 5-6 lin. lata $1\frac{1}{2}$ lin. crassa facie turgida dorso carinata superne translucida lineis 5-7 viridibus percursa apice pellucido-aristata, marginibus carinaque setis pellucidis deltoideo-cuspidatis $\frac{1}{2}$ lin. longis armatis. Pedunculus simplex semipedalis. Racemus laxis pauciflorus semipedalis, pedicellis inferioribus $1\frac{1}{2}$ -2 lin. longis, bracteis lanceolatis. Perianthium 7-8 lin. longum, segmentis quam tubus duplo brevioribus. *C. B. Spei*, anno 1795 a Masson introducta.

53. *H. PALLIDA*, *Haw. Revis.* 56.—*Aloe pallida*, *Roem. et Schultes, Syst.* vii. 641; *Kunth, Enum.* iv. 514. Rosula foliorum 1 poll. longa 2-3 poll. diam. Folia circiter 30 multifaria ascendentia lanceolata 15-16 lin. longa 4-4 $\frac{1}{2}$ lin. lata 3 lin. crassa pallide glauco-viridia facie plana superne pellucida lineata subtuberculata apice pellucido-aristata dorso rotundata superne bicarinata, marginibus carinaque setis albidis $\frac{1}{2}$ lin. longis armatis. Pedunculus simplex semipedalis vel pedalis. Racemus simplex 4-6-pollicaris, pedicellis inferioribus 1-2 lin. longis, bracteis lanceolatis. Perianthium 7-8 lin. longum, segmentis subregulariter falcatis tubo æquilongis. *C. B. Spei*, a Bowie anno 1820 introducta. *Habitus H. setatæ*; recedit aculeis brevioribus et limbo subregulari.

54. *H. PILIFERA*, *Baker in Saund. Ref. Bot.* t. 234. Rosula foliorum 1 poll. longa 2 poll. diam. Folia 20-30 multifaria oblonga 1 poll. longa medio $\frac{1}{2}$ poll. lata 3-3 $\frac{1}{2}$ lin. crassa pallide viridia immaculata sursum aquoso-pellucida lineis verticalibus viridibus 7-9 percursa facie subconvexa dorso rotundata sursum carinata apice cuspidata pellucido-aristata, margi-

nibus carinaque setis pellucidis crebris $\frac{1}{4}$ – $\frac{1}{2}$ lin. longis armatis. Pedunculus simplex 6–8-pollicaris. Racemus laxus semipedalis, pedicellis brevissimis, bracteis parvis lanceolatis. Perianthium 8–9 lin. longum, segmentis quam tubus duplo brevioribus. *C. B. Spei*, anno 1860 a Cooper introducta.

55. H. COOPERI, *Baker in Saund. Ref. Bot.* t. 233. Rosula foliorum $1\frac{1}{2}$ poll. longa $2\frac{1}{2}$ –3 poll. diam. Folia 30–40 oblongo-lanceolata acuta 15–21 lin. longa 7–8 lin. lata medio 3 lin. crassa pallide viridia sursum aquoso-pellucida lineis 7–9 viridulis percursa facie turgida dorso rotundata sursum regulariter carinata apice pellucido-aristata, marginibus carinaque setis lanceolatis pellucidis $\frac{1}{2}$ lin. longis armatis. Pedunculus simplex subpedalis. Racemus semipedalis, pedicellis brevissimis, bracteis parvis lanceolatis. Perianthium 8–9 lin. longum, segmentis quam tubus duplo brevioribus. *C. B. Spei*, anno 1860 a Cooper introducta.

56. H. MINIMA, *Baker*. Rosulæ foliorum cæspitose 12–15 lin. diam. Folia 40–50 densa multifaria lanceolata acuta 6–8 lin. longa 2 lin. lata medio 1 lin. crassa pallide glauco-viridia concoloria facie turgida apice pellucido-aristata dorso rotundata superne carinata, marginibus carinaque setis pellucidis lanceolato-cuspidatis crebris $\frac{1}{2}$ lin. longis armatis. Pedunculus simplex rubro tinctus 3–4-pollicaris. Racemus 10–12-florus 2–3-pollicaris, pedicellis inferioribus $1\frac{1}{2}$ –2 lin. longis, bracteis lanceolatis. Perianthium 6 lin. longum, segmentis subregulariter falcatis quam tubus duplo brevioribus. *C. B. Spei*, anno 1872 a Tuck introducta. Ab *Pallidis* reliquis recedit foliis sursum haud aquoso-pellucidis.

57. H. ARACHNOIDES, *Haw. Syn.* 96.—*Aloe arachnoides*, *Miller, Dict.* edit. vi. No. 17; *Haw. in Trans. Linn. Soc.* vii. 10; *DC. Plantes Grasses*, t. 50; *Bot. Mag.* t. 756; *Salm-Dyck, Aloe*, sect. xii. fig. 2; *Kunth, Enum.* iv. 513.—*Apicra arachnoides*, *Willd. in Berl. Mag.* v. 268.—*Catevala arachnoidea*, *Medic. Theod.* 68.—*Aloe pumila*, var. *arachnoidea*, *Linn. Sp.* 460.—*A. africana humilis arachnoidea*, *Commel. Prælucl.* t. 27. Rosula foliorum $1\frac{1}{2}$ poll. longa 3–4 poll. diam. Folia 30–40 multifaria oblongo-lanceolata $1\frac{1}{2}$ –2 poll. longa 7–8 lin. lata $1\frac{1}{2}$ lin. crassa pallide glauco-viridia sursum utrinque aquoso-pellucida lineis crebris viridulis verticalibus percursa apice longe pellucido-aristata dorso rotundata superne 1–2-carinata, marginibus carinisque setis pellucidis lanceolato-cuspidatis 1 – $1\frac{1}{2}$ lin. longis armatis. Pedunculus strictus simplex semipedalis vel pedalis. Racemus laxus semipedalis, pedicellis 1 – $1\frac{1}{2}$ lin. longis, bracteis lanceolatis. Perianthium 7–8 lin. longum, segmentis quam tubus duplo brevioribus. *C. B. Spei*, a temporibus remotis in hortis culta.

58. H. BOLUSII, *Baker*. Rosula foliorum 15–18 lin. longa $2\frac{1}{4}$ –3 poll. diam. Folia 30–40 multifaria densa ascendente oblongo-lanceolata 12–15 lin. longa medio 5–6 lin. lata 2 lin. crassa pallide viridia sursum aquoso-pellucida lineis pluribus viridibus longitudinalibus percursa, apice arista

pellucida 6-8 lin. longa prædita dorso rotundata sursum carinata, marginibus carinaque setis pellucidis crebris lanceolato-subulatis $1\frac{1}{4}$ -2 lin. longis armatis. Pedunculus simplex semipedalis. Racemus semipedalis multiflorus, pedicellis infimis $1\frac{1}{2}$ -2 lin. longis, bracteis lanceolatis. Perianthium 6-7 lin. longum, segmentis quam tubus duplo brevioribus. *C. B. Spei*, anno 1823 a *Bowie* introducta. *Graaf-Reinet*, Bolus 158! Ab *H. arachnoide* præsertim recedit foliorum setis longioribus tenuioribus.

59. *H. SETATA*, *Haw. Suppl.* 52, *Revis.* 36.—*Aloe setosa*, *Roem. et Schultes, Syst.* vii. 641; *Salm-Dyck, Aloe*, sect. xii. fig. 3; *Kunth, Enum.* iv. 513. Rosula foliorum $1\frac{1}{2}$ poll. longa $2\frac{1}{2}$ poll. diam. Folia 30-40 densa multifaria ascendente oblongo-lanceolata acuta 12-15 lin. longa 6-7 lin. lata $2-2\frac{1}{2}$ lin. crassa viridia concoloria facie turgida apice longe pellucido-aristata dorso rotundata 1-2-carinata, marginibus carinisque setis pellucidis subdistantibus lanceolato-cuspidatis 1 lin. longis armatis. Pedunculus simplex semipedalis. Racemus laxus semipedalis, pedicellis brevissimis, bracteis parvis lanceolatis. Perianthium 6-7 lin. longum, segmentis quam tubus duplo brevioribus. *C. B. Spei*, anno 1818 a *Mackrell* introducta. Var. *NIGRICANS*, *Haw.*, est forma foliis atroviridibus setis tenuioribus crebrioribus.

4. *APICRA*, *Willd.*

Willd. in Berl. Mag. v. 271, *ex parte*; *Haw. Suppl.* 61.—*Haworthia*, *Haw. Syn.* 90, *ex parte*.—*Aloe*, *Linn. Gen.* No. 430, *ex parte*.—*Aloe*, sect. i. et ii., *Salm-Dyck, Aloe*; *Kunth. Enum.* iv. 494.

Perianthium albidum flavido vel viridi tinctum, tubo oblongo recto, segmentis 6 subæqualibus brevibus flore expanso æquilatèraliter falcatis quam tubus 3-4plo brevioribus. *Stamina* 6 hypogyna tubo æquilonga, filamentis filiformibus, antheris minutis subglobosis versatilibus. *Ovarium* oblongum sessile triloculare, ovulis in loculo crebris superpositis; *stylus* filiformis leviter declinatus ovario æquilongus, stigmatè capitato. *Capsula* et semina *Haworthiæ*. *Plantæ parvæ, rosulis foliorum semper elongatis, foliis crassis latis nunquam spinoso-dentatis, pedunculis simplicibus vel furcatis, floribus parvis laxè dispositis subspicatis.*

Folia (in typo) in series 5 rectas regulariter disposita.

1. *A. pentagona*. 2. *A. deltoidea*.

Folia multifaria vel obscure spiraliter 5-faria.

Perianthium extus verrucosum ... 3. *A. spiralis*.

Perianthium extus læve.

Folia dorso lævia.

4. *A. congesta.*5. *A. foliolosa.*

Folia dorso tuberculis emersis aspera.

6. *A. aspera.*7. *A. bicarinata.*

1. *A. PENTAGONA*, Willd. in *Berl. Mag.* v. 273; *Haw. Suppl.* 62.—*Aloe pentagona*, *Haw. in Trans. Linn. Soc.* vii. 7; *Ker in Bot. Mag.* t. 1338; *Jacq. Fragm.* t. 111; *Salm-Dyck, Aloe*, sect. i. t. 4.—*Haworthia pentagona*, *Haw. Syn.* 97. Rosula foliorum semipedalis et ultra 2½–3 poll. diam. Folia densa regulariter quinquefaria (inferiora patula, superiora ascendunt) lanceolato-deltaidea 15–18 lin. longa deorsum 6–8 lin. lata nitide viridia facie plana medio 3–4 lin. crassa apice pungentia margine scabra dorso apice irregulariter 1–2-carinata tuberculis paucis albidis prædita. Pedunculus pedalis sæpe ramosus. Racemus semipedalis et ultra laxus, pedicellis inferioribus 2–3 lin. longis, bracteis minutis lanceolato-deltaideis. Perianthium albidum viridi vittatum 6–7 lin. longum læve, segmentis oblongis obtusis.

Var. *A. SPIRELLA*.—*Haworthia spirella*, *Haw. Syn.* 97.—*Aloe spirella*, *Salm-Dyck, Aloe*, sect. i. figs. 3 & 3β, a typo recedit foliis minoribus magis deltaideis 1 poll. longis deorsum 6–8 lin. latis irregulariter quinquefariis vel quasi multifariis.

Var. *A. BULLULATA*, Willd. in *Berl. Mag.* v. 273; *Haw. Suppl.* 62.—*Aloe bullulata*, *Jacq. Fragm.* t. 109, a typo recedit foliis irregulariter spiritaliter quinquefariis dorso tuberculis rugosis crebris præditis.

Var. *WILLDENOVII*, Baker.—*A. spiralis*, Willd. in *Berl. Mag.* v. 273. *Haworthia spiralis*, *Haw. Syn.* 97.—*Aloe spiralis*, *Haw. in Trans. Linn. Soc.* vii. 6; *Salm-Dyck, Aloe*, sect. i. fig. 3, non Linn. Major, rosula foliorum 3–4 poll. diam., seriebus 5 foliorum imbricatorum spiritaliter tortorum.

2. *A. DELTOIDEA*, Baker.—*Aloe (Apicra) deltaidea*, *Hook. fil. in Bot. Mag.* t. 6071.—Rosula foliorum semipedalis vel pedalis 2 poll. diam. Folia regulariter quinquefaria summis exceptis patula 9–12 lin. longa deltaidea nitide viridia haud tuberculata matura facie subplana apice pungentia medio 2–3 lin. crassa dorso superne distincte carinata, marginibus et carina minute serrulatis. Pedunculus subpedalis simplex vel ramosus. Racemus semipedalis et ultra subspicatus, pedicellis infimis brevissimis, bracteis lanceolato-deltaideis 3–4 lin. longis. Perianthium viridulum 5–6 lin. longum læve, segmentis albidis subrotundis apice erosis quam tubus quadruplo brevioribus. *C. B. Spei, in lapidosis montis Zuurberg*, Bolus 2687! Cooper in hortos nostros introduxit anno circiter 1865. Varietatem foliis crassioribus multifariis in hort. Peacock vidi.

3. *A. SPIRALIS*, Baker, non Willd.—*Aloe spiralis*, *Linn. Sp.* 459; *DC. Plantes Grasses*, t. 56; *Jacq. Fragm.* t. 110; *Ker in Bot. Mag.* t. 1455.

—*A. imbricata*, *Haw. in Trans. Linn. Soc.* vii. 7; *Salm-Dyck, Aloe*, sect. i. fig. 1.—*Haworthia imbricata*, *Haw. Syn.* 98.—*Apicra imbricata*, *Willd. in Berl. Mag.* v. 273.—*A. africana erecta*, etc., *Dill. Hort. Elth.* tab. 13. fig. 14; *Commel. Prælug.* t. 32. Rosula foliorum semipedalis vel pedalis 18–21 lin. diam. Folia densa multifaria valde ascendentia lanceolato-deltaidea 12–15 lin. longa 6–8 lin. lata viridia facie subplana utrinque lævia haud tuberculata apice pungentia medio 3 lin. crassa dorso turgida vix carinata, marginibus obscure crenulatis. Pedunculus subpedalis simplex vel ramosus. Racemus laxus semipedalis, pedicellis ascendentibus 2–3 lin. longis, bracteis lanceolato-deltaideis pedicello æquilongis. Perianthium albido-viridulum 6 lin. longum insigniter verrucosum, segmentis parvis oblongis flavidis. *C. B. Spei.*

4. *A. CONGESTA*, *Baker*.—*Aloe congesta*, *Salm-Dyck, Aloe*, sect. ii. fig. 1. Rosula foliorum pedalis 3 poll. diam. Folia densissima summis exceptis patula multifaria lanceolato-deltaidea 18–21 lin. longa deorsum 1 poll. lata viridia immaculata haud tuberculata facie subplana medio 3–4 lin. crassa dorso convexa apice inæquilateraliter carinata ad margines carinamque crenulata scabra. Pedunculus subpedalis simplex. Racemus laxus subspicatus semipedalis, pedicellis infimis brevissimis, bracteis lanceolato-deltaideis 3–4 lin. longis. Perianthium 6–7 lin. longum læve albidum viridi vittatum, segmentis oblongis quam tubus triplo brevioribus. *C. B. Spei*, circiter annum 1843 introducta.

5. *A. FOLIOLOSA*, *Willd. in Berl. Mag.* v. 274; *Haw. Suppl.* 64.—*Haworthia foliolosa*, *Haw. Syn.* 99.—*Aloe foliolosa*, *Haw. in Trans. Linn. Soc.* vii. 7; *Ker in Bot. Mag.* t. 1352; *Salm-Dyck, Aloe*, sect. ii. fig. 4; *Kunth, Enum.* iv. 495. Caulis foliiferus interdum pedalis 12–14 lin. diam. Folia densissima summis exceptis patula multifaria rotundato-deltaidea cuspidata 6–8 lin. longa et lata viridia immaculata haud tuberculata facie subplana medio $1\frac{1}{2}$ –2 lin. crassa dorso sursum oblique carinata ad margines carinamque obscure crenulata. Pedunculus subpedalis simplex. Racemus laxiflorus subspicatus semipedalis, pedicellis infimis 2–3 lin. longis, bracteis parvis lanceolatis. Perianthium viridulum 5–6 lin. longum læve, segmentis albidis rotundis. *C. B. Spei*, anno 1795 a Masson introducta.

6. *A. ASPERA*, *Willd. in Berl. Mag.* v. 274; *Haw. Suppl.* 63.—*Haworthia aspera*, *Haw. Syn.* 90.—*Aloe aspera*, *Haw. in Trans. Linn. Soc.* vii. 6; *Salm-Dyck, Aloe*, sect. ii. fig. 2; *Kunth, Enum.* iv. 496. Rosula foliorum 4–6-pollicaris 15–16 lin. diam. Folia densa multifaria summis exceptis patula rotundato-deltaidea 6–7 lin. longa et lata facie subplana lævia medio 3–4 lin. crassa dorso convexa hemisphærica papillis concoloribus rugosis ubique prædita ad margines crenulata scabra. Pedunculus gracilis simplex semipedalis. Racemus laxus 3–4-pollicaris, pedicellis infimis 3–4 lin. longis, bracteis minutis lanceolatis. Perianthium 6 lin.

longum læve viridi vittatum, segmentis oblongis obscure bilabiatis. *C. B. Spei*, anno 1795 a Masson introducta.

Var. MAJOR, *Haw. Suppl.* 63. Rosula foliorum semipedalis vel pedalis 2 poll. diam. Folia deltoidea 9–12 lin. longa deorsum 8–9 lin. lata 2 lin. crassa magis ascendentia facie in senioribus subplana dorso superne carinata tuberculis emersis ubique prædita. Pedunculus pedalis interdum furcatus. Racemus laxus 6–8-pollicaris expansus 15–16 lin. diam., pedicellis erecto-patentibus $1\frac{1}{2}$ –2 lin. longis. Perianthium 7–8 lin. longum. *C. B. Spei*. V. v. in hort. Kew.

7. A. BICARINATA, *Haw. Suppl.* 63.—*Aloe bicarinata*, *Roem. et Schultes, Syst.* vii. 652; *Kunth, Enum.* iv. 496. Rosula foliorum 6–9-pollicaris 18–21 lin. diam. Folia densa multifaria ascendentia lanceolato-deltoidea 9–12 lin. longa 6 lin. lata sordide viridia facie lævia in foliis adultis plana medio 2 lin. crassa margine scabra dorso tuberculis copiosis emersis asperis quam ea *A. asperæ* majoribus apice albidis transversaliter et verticaliter subseriatis præditis basi lævia sursum bicarinata. Flores ignoti. *C. B. Spei*, Hort. Kew. anno 1818 Mackrell misit iconem! *Orange Free State*, Cooper!

5. YUCCA, *Linn.*

Linn. Gen. No. 429; *Endl. Gen.* No. 1117; *Haw. Suppl.* 31; *Carrière in Rev. Hort.* viii. (1859) 395; *Lemaire in Ill. Hort.* xiii. (1866), *Misc.* 92; *Baker in Gard. Chron.* 1870, 828; *Engelm. Monogr. in Trans. Acad. Sc. St. Louis*, iii. 18; *Hemsley in Garden*, viii. (1875) 129; *Hamb. Gartenzeit.* xxxi. 435; *K. Koch in Berl. Monat.* 1873, 204; *S. Wats. in Proc. Amer. Acad.* xiv. 251.

Perianthium polyphyllum campanulatum album extus sæpe rubro vel viridi tinctum, segmentis subconformibus ovatis vel oblongis acutis venis indistinctis dispersis. *Stamina* 6 perianthio multo breviora, filamentis sæpissime clavatis obscure perigynis papillosis apice post anthesin falcatis, antheris minutis oblongis dorsifixis. *Ovarium* cylindricum vel oblongum 6-angulatum triloculare, carpellorum suturis dorsalibus introflexis imperfecte 6-loculare, ovulis in loculo crebris biseriatis horizontalibus; stylus sæpissime crassus stigmatibus magnis quadratis emarginatis deorsum coalitis, raro cylindricus stigmatibus capitato. *Fructus* varius, magnus, baccatus, siccus, indehiscens vel capsularis, septicide vel loculicide trivalvis. Semina discoidea, testa nigra, albumine firmo integro vel ruminato, embryone axili. *Arbores, frutices vel suffrutices Americanæ, caule infra foliorum rosulas sæpe producto, foliis plurimis dense rosulatis persistentibus linearibus vel ensiformibus, margine integro, serrulato vel filifero, floribus magnis vespertinis*

in paniculam amplam dispositis rarissime simpliciter racemosis, bracteis persistentibus, pedicellis solitariis cernuis apice articulatis.

Subgenus *EUYUCCA*, *Engelm.* Filamenta clavata papillosa profunde perigyna. Stylus crassus, stigmatibus quadratis emarginatis.

Clavis secundum folia.

SERRULATÆ. Folia margine serrulata.

Caulscentes, pedunculis brevibus.

- | | | |
|-------------------------|--------------------------|-----------------------------|
| 1. <i>Y. aloifolia.</i> | 2. <i>Y. yucatana.</i> | 3. <i>Y. brevifolia.</i> |
| | 4. <i>Y. Desmetiana.</i> | 5. <i>Y. guatemalensis.</i> |

Acaulis, pedunculo elongato 6. *Y. rupicola.*

INTEGRIFOLLÆ. Folia margine integra (vetustate interdum parce filifera, juvenilia deorsum obscure serrulata).

Acaules 7. *Y. glauca.* 8. *Y. exigua.*

Caulscentes.

Angustifoliæ.

- | | | |
|-------------------------|---------------------------|-------------------------|
| 9. <i>Y. Peacockii.</i> | 10. <i>Y. Boerhaavii.</i> | 11. <i>Y. flexilis.</i> |
|-------------------------|---------------------------|-------------------------|

Latifoliæ.

- | | | |
|-------------------------|-------------------------|---------------------------|
| 12. <i>Y. gigantea.</i> | 13. <i>Y. gloriosa.</i> | 14. <i>Y. Treculeana.</i> |
|-------------------------|-------------------------|---------------------------|

FILIFERÆ. Folia margine filis dejectis copiosis instructa.

Acaules.

- | | | |
|-----------------------------|----------------------------|-------------------------|
| 15. <i>Y. angustifolia.</i> | 16. <i>Y. filamentosa.</i> | 17. <i>Y. funifera.</i> |
|-----------------------------|----------------------------|-------------------------|

Caulscentes.

- | | | |
|-------------------------|---------------------------|------------------------|
| 18. <i>Y. Schottii.</i> | 19. <i>Y. constricta.</i> | 20. <i>Y. baccata.</i> |
|-------------------------|---------------------------|------------------------|

Clavis secundum fructus.

SARCOYUCCA, *Engelm.* Fructus baccatus, seminibus crassis, albumine ruminato.

- | | | | |
|----------------------|-----------------------|--------------------|---------------------|
| <i>Y. aloifolia.</i> | <i>Y. Treculeana.</i> | <i>Y. baccata.</i> | <i>Y. Schottii.</i> |
|----------------------|-----------------------|--------------------|---------------------|

CLISTOYUCCA, *Engelm.* Fructus indehiscens demum siccatus, seminibus tenuibus, albumine integro.

- | | |
|---------------------|-----------------------|
| <i>Y. gloriosa.</i> | <i>Y. brevifolia.</i> |
|---------------------|-----------------------|

CHENOYUCCA, *Engelm.* Fructus capsularis septicide trivalvis,

loculis demum apice apertis, seminibus tenuibus, albumine integro.

Y. rupicola. *Y. angustifolia.* *Y. constricta.* *Y. filamentosa.*

Subgenus *HESPEROYUCCA*, *Engelm.* Filamenta subulata glabra alte perigyna. Stylus gracilis, stigmatē parvo capitato.

Species sola 21. *Y. Whipplei.*

1. *Y. ALOIFOLIA*, *Linn. Sp.* 457 (*Dill. Hort. Elth.* tab. 323. fig. 416; *Commel. Prælucl. t.* 14); *DC. Plantes Grasses*, t. 20; *Red. Lil. t.* 401, 402; *Bot. Mag. t.* 1700; *Haw. Suppl.* 32; *Engelm. Mon.* 34.—*Y. serrulata*, *Haw. Syn.* 69. Caulis gracilis elongatus interdum 15–20-pedalis sæpissime simplex. Rosula foliorum 2–3 pedum diam. Pars foliosa caulis semipedalis vel pedalis. Folia 50–100 rigida ensiformia pedalia vel sesquipedalia medio 12–15 lin. supra basin 8–9 lin. lata recta saturate viridia glauco tincta, apice pungente corneo rubro-brunneo, margine albedo serrulato. Pedunculus brevissimus. Panicula rhomboidea densa pedalis vel bipedalis, ramis ascendentibus centralibus semipedalibus, bracteis parvis lanceolatis, pedicellis inferioribus 12–18 lin., superioribus 6–9 lin. longis. Perianthium album 1½–2 poll. longum, segmentis oblongis vel oblongo-lanceolatis medio 6–12 lin. latis. Ovarium 6–9 lin. longum, stylo brevi crasso. Stamina pistillo paulo breviora. Fructus baccatus oblongus prismaticus 3–4-poll. caris 15–21 lin. diam., seminibus 1½ lin. crassis. *India occidentalis et Mexico ad Carolinam borealem.* *Y. SERRULATA*, *Haw. Suppl.* 32, est forma foliis paulo angustioribus; *Y. TRICOLOR hort.* (*Y. lineata lutea, hort.*) est forma in hortis communis, foliis albo et luteo variegatis; *Y. QUADRICOLOR hort.* est forma foliis etiam rubello tinctis; *Y. PURPUREA* et *ATKINSI hort.* sunt formæ nanæ foliis purpurascensibus; *Y. CRENULATA*, *ARCUATA*, et *TENUIFOLIA*, *Haw. Suppl.* 33, 34, sunt formæ parvæ foliis angustis minus strictis plus minusve arcuatis; *Y. DRACONIS*, *Linn. Sp.* 457 (*Dill. Hort. Elth. t.* 417), est forma foliis laxioribus longioribus recurvatis; et *Y. CONSPICUA*, *Haw. Suppl.* 32, forma foliis laxioribus latioribus recurvatis medio 1½ poll. latis, cujus exemplum silvestre vidi a *Mexico prope urbem Cuernavaca*, Bourgeau 1408!

2. *Y. YUCATANA*, *Engelm. Monogr.* 37. Caulis ad 20-pedalis e basi ramosus. Folia ensiformia 14–16 poll. longa medio 1 poll. lata crassa lævia vix rigida ad basin vix angustata, margine obscure serrulato. Pedunculus subnullus. Panicula densa, ramis dense pubescentibus, bracteis albis lanceolatis. Perianthium 14 lin. longum, segmentis ovato-lanceolatis. Ovarium ei *aloifoliæ* conformia, stylo brevissimo, stigmatibus parvis erectis emarginatis. Stamina ovario distincte breviora, filamentis post anthesin falcatis. *Mexico in ditone Yucatan*, Dr. A. Schott.

3. *Y. BREVIFOLIA*, *Engelm. in S. Wats. Bot. 40th Parall.* 496; *Monogr.*

47; *S. Wats. in Proc. Amer. Acad.* xiv. 252.—*Y. Draconis*, var.? arborescens, *Torrey in Pacif. R. Report*, iv. 147. Arborescens 15–30-pedalis, trunco 1–2 ped. diam. sursum ramosissimo. Folia densa rigidissima crassa semipedalia, vel in plantis juvenilibus interdum pedalia, medio 3–4 lin. lata supra basin dilatatam deltoideam canaliculata, apice brunneo pungente, marginibus pallidis conspicue serrulatis. Pedunculus brevis. Panicula densa, pedicellis pro genere brevissimis, floribus erectis albo-viridulis. Perianthium $1\frac{1}{2}$ –2 poll. longum, segmentis lanceolatis. Stamina ovario subduplo breviora. Stylus subnullus, stigmatibus brevibus. Fructus indehiscens oblongus demum siccatus 2–3 poll. longus, pericarpio brunneo fragili, seminibus $1\frac{1}{2}$ lin. crassis. *California austro-orientalis, Arizona, Nevada, Utah, alt. 2000–4000 pedum ad montes aridos.*

4. *Y. DESMETIANA*, *Baker in Gard. Chron.* 1870, 1217; *Engelm. Mon.* 41. Caulis simplex gracilis, apice folioso pedali vel sesquipedali. Folia 100–200 sublaxe disposita linearia subpedalia medio 6–9 lin., supra basin 3–4 lin. lata, modice firma omnia recurvata, juniora purpurea glauca, seniora viridia medio plana basi et apice solum leviter concava apice haud pungentia, margine pallido angusto sursum integro deorsum serrulato, basi dilatata striata more *Y. aloifoliae* perspicua. Flores ignoti. *Mexico.*

5. *Y. GUATEMALENSIS*, *Baker in Saund. Ref. Bot.* t. 313; *Engelm. Mon.* 38.—*Y. Roezlii et Ghiesbreghtii hort.*—*Dracæna Ehrenbergii*, *Fintelmanni*, *Lennei*, yuccoides et ensifolia *hort.* Habitus omnino *Y. aloifoliae*. Caulis interdum 15–20-pedalis sæpissime simplex basi tuberosus. Pars foliosa caulis 1–2-pedalis. Folia 50 vel ultra laxè disposita ensiformia 2–3-pedalia medio 2–3 poll., supra basin 10–12 lin. lata nitide viridia lævia, apice vix pungente, margine obscure serrulato albido, superiora ascendentia multo recurvata. Pedunculus brevissimus. Panicula densa rhomboidea 2–3-pedalis, ramis centralibus semipedalibus, pedicellis 9–18 lin. longis, bracteis albis scariosis pedicello brevioribus. Perianthium album $2\frac{1}{2}$ –3 poll. longum, segmentis oblongo-lanceolatis acutis 9–12 lin. latis, exterioribus latioribus. Ovarium oblongum 7–8 lin. longum, stylo crasso 1 lin. longo, stigmatibus quadratis patulis profunde emarginatis, stylo æquilongis. Stamina ovario distincte breviora, filamentis apice post anthesin patulis. Fructus ignotus. *Mexico et Guatemala*, ab Ehrenberg versus annum 1850 in hortos introducta. *Hacienda de la Laguna*, Schiede & Deppe anno 1829! (*Herb. Mus. Brit.*). *Y. MOOREANA*, *hort. Peacock*, a typo recedit floribus multo minoribus, segmentis ovato-lanceolatis $1\frac{1}{2}$ poll. longis.

6. *Y. RUPICOLA*, *Scheele in Linnæa*, xxiii. (1850) 143; *Engelm. Monogr.* 48; *S. Wats. in Proc. Amer. Acad.* xiv. 253.—*Y. lutescens*, *Carrière in Rev. Hort.* vii. (1858) 579.—*Y. tortifolia*, *Lindheimer MSS.*—*Y. tortilis et contorta hort.* Acaulis. Folia densa ensiformia sesquipedalia vel bipedalia medio 9–18 lin., supra basin 5–6 lin. lata, textura iis *gloriosæ* consi-

milia modice firma sæpe contorta, apice pungente, marginibus pallidis serrulatis, saturate viridia, facie lævia, dorso scabrula. Pedunculus tripedalis, foliis paucis reductis præditus. Panicula laxa, ramis ascendentibus inferioribus semipedalibus, pedicellis 6-9 lin. longis, bracteis parvis lanceolatis. Perianthium albidum extus viridulum 2-3 poll. longum, segmentis oblongis acutis medio 9-14 lin. latis. Ovarium cylindricum 7-8 lin. longum; stylus ovario æquilongus, stigmatibus parvis. Stamina ovario longiora, filamentis post anthesin vix divergentibus. Fructus capsularis rostratus 2-2½ poll. longus 1 poll. diam., seminibus tenuibus. *Texas*, Lindheimer 709! A Trécul versus annum 1850 introducta.

Var. *RIGIDA*, *Engelm. loc. cit.* Folia rigidiora pallidiora glauco tincta recta 8-12 poll. longa medio 4-6 lin. lata. Inflorescentia 5-10-pedalis. Perianthium 2 poll. longum. Capsula sesquipollicaris. *New Mexico et Mexico borealis.*

7. *Y. GLAUCA*, *Sims in Bot. Mag. t. 2662; Kunth, Enum. iv. 274; Baker in Saund. Ref. Bot. t. 315.* Acaulis. Folia 25-30 densa ensiformia sesquipedalia medio 15-18 lin., supra basin 5-6 lin. lata consistentia iis *filamentosæ* consimilia, juniora leviter glauco tincta facie medio subplana apice subpungentia margine angustissime rubro-brunneo integro vel parce filifero, exteriora recurvata. Pedunculus foliis duplo longior. Panicula rhomboidea 2-3-pedalis, ramis ascendentibus glabris, bracteis parvis lanceolatis, pedicellis inferioribus 5-6 lin. longis. Perianthium albidum late campanulatum, segmentis oblongis 1½ poll. longis. Ovarium cylindricum, stylis quam ovarium triplo brevioribus. Stamina ovario æquilonga post anthesin divergentia. Fructus ignotus. *America borealis australis.* V. v. in hort. Saunders. An sit varietas *Y. filamentosæ?*

8. *Y. EXIGUA*, *Baker in Saund. Ref. Bot. t. 314.* Acaulis. Folia 30-40 ensiformia sesquipedalia supra medium 12-15 lin., basi 3-4 lin. lata obscure viridia iis *Y. gloriosæ* consistentia consimilia facie lævia concava dorso scabrula apice pungentia, margine integro brunneo. Inflorescentia 5-6-pedalis. Pedunculus elongatus, foliis multis reductis lanceolatis præditus. Panicula laxa tripedalis, ramis semipedalibus pubescentibus ascendentibus, pedicellis brevissimis, bracteis magnis lanceolatis scariosis pedicello longioribus. Perianthium campanulatum extus viridulo tinctum, segmentis oblongis acutis 1½ poll. longis. Ovarium cylindricum 9-10 lin. longum, stylis quam ovarium triplo brevioribus, stigmatibus parvis. Stamina ovario æquilonga post anthesin divergentia. *America borealis australis.* Stirps singularis, inter *filamentosam* et *gloriosam* medium tenens, foliis magis posterioris sed deorsum valde angustatis, floribus bracteis pedicellisque prioris.

9. *Y. PEACOCKII*, *Baker.*—*Y. lævigata hort. Peacock.* Acaulis. Rosula foliorum 3 pedum diam. Folia 100 densa stricta linearia 15-18 poll.

longa medio 1 poll., supra basin 4 lin. lata obscure viridia facie lævia canaliculata apice pungentia dorso rotundata scabrula, margine integro rubro-brunneo. Flores ignoti. *Mexico?* V. v. in hort. Peacock anno 1879.

10. Y. BOERHAAVII, *Baker in Gard. Chron.* 1870, 127; *Engelm. Mon.* 41. Breviter caulescens, caule gracili apice folioso bipedali. Folia 200 linearia stricta (inferiora solum recurvata) bipedalia et ultra medio 9-12 lin. lata acuminata ad basin valde dilatata vix angustata saturate viridia (juniora leviter glaucescentia) ubique lævissima facie media plana apice vix pungentia, margine integro angustissime rubro-brunneo vel pallido. Flores ignoti. *Mexico?* V. v. in hort. Saunders.

11. Y. FLEXILIS, *Carrière in Rev. Hort.* viii. (1859) 398, tab. 89.—Y. mexicana, stenophylla, acuminata, angustifolia, et longifolia hort. Breviter caulescens, caudice simplici. Folia densa linearia 2-2½-pedalia medio 1-1½ poll., basi 5-6 lin. lata modice firma nitide viridia (juniora leviter glaucescentia) medio plana obscure plicata apice pungentia, margine corneo rubro-brunneo integro vel interdum deorsum obscure serrulato. Inflorescentia 4-pedalis, pedunculo subpedali, ramis centralibus semipedalibus 6-9-floris, pedicellis 6-9 lin. longis, bracteis parvis. Perianthium album 3 poll. longum, segmentis oblongis acutis. Ovarium cylindricum 8-9 lin. longum, stylis quam ovarium triplo brevioribus, stigmatibus parvis emarginatis. Stamina pistillo vix breviora, post anthesin divergentia. Fructus mihi ignotus. *Mexico.*

Var. Y. ENSIFOLIA, *Baker in Saund. Ref. Bot.* t. 318.—Y. Eylesii hort. Peacock. Caulis gracilis interdum 4-5-pedalis. Folia 40-80 substricta pallide viridia (primum leviter glaucescentia) 2-2½-pedalia medio 15-18 lin. lata. Pedunculus foliis paulo brevior. Perianthium 2 poll. longum extus leviter rubro tinctum. Stamina ovario æquilonga.

Var. Y. FALCATA, hort. Peacock.—Y. gloriosa, var. planifolia, *Engelm. Mon.* 39? Subacaulis, foliis 100-150 viridibus strictis bipedalibus medio 15-18 lin. latis. Pedunculus foliis duplo brevior. Panicula rhomboidea sublaxa bipedalis, floribus albis extus leviter viridi tinctis 2-2½ poll. longis.

Var. ? Y. NOBILIS, hort. Peacock. Breviter caulescens, foliis 60-80 substrictis 12-15 poll. longis medio 15-18 lin. latis facie concavis junioribus valde glaucescentibus, margine corneo pallido vel rubro-brunneo. Flores ignoti.

Var. ? Y. SEMICYLINDRICA, *Baker in Gard. Chron.* 1870, 1217. Breviter caulescens, foliis 40-50 sesquipedalibus vel bipedalibus medio 9-10 lin., supra basin 3-4 lin. latis pallide viridibus (primum leviter glaucescentibus) exterioribus recurvatis facie e basi ad apicem canaliculatis margine rubro-brunneis. Flores ignoti.

12. Y. GIGANTEA, *Lemaire, Ill. Hort.* vi. (1859), *Misc.* 91; *Carrière in Rev. Hort.* ix. (1860) 222. Caulis (in horto) simplex gracilis 3-4-pedalis. Apex foliosus caulis sesquipedalis. Folia ensiformia stricta patula nitide viridia 4-5-pedalia medio 3-3½ poll. lata acuminata medio

plana apice pungentia margine tenuissime albido deorsum scabro, inferiora vix recurvata. Panicula 2-2½-pedalis, ramis 12-15, centralibus subpedalibus 8-10-floris. Perianthium album 3-3½ poll. longum, segmentis oblongis acutis. Ovarium oblongum 9-10 lin. longum. *Mexico?* Hort. Verschaffelt anno 1859. Non vidi.

13. *Y. GLORIOSA*, *Linn. Sp.* 456 (*Parkins, Parad.* 435, fig. 1); *Red. Lil.* t. 326, 327; *Bot. Mag.* t. 1260; *Haw. Suppl.* 37; *Kunth, Enum.* iv. 273; *Engelm. Mon.* 38; *Carrière in Rev. Hort.* ix. 359; *Baker in Saund. Ref. Bot.* t. 320; *S. Wats. in Proc. Amer. Acad.* xiv. 251. Caulis brevis (vetustate 4-6-pedalis) simplex vel ramosus. Folia 100 vel plura dense rosulata ensiformia 1½-3-pedalia medio 2-3 poll., supra basin 1 poll. lata, rigida recta obscure viridia leviter glaucescentia facie lævia leviter concava dorso scabrula apice pungentia, margine anguste rubro-brunneo integro vel in formis juvenilibus deorsum obscure serrulato. Inflorescentia 5-8-pedalis, pedunculo elongato foliis reductis multis patulis prædito. Panicula rhomboidea subdensa 4-6-pedalis, ramis erecto-patentibus glabris vel pubescentibus, inferioribus pedalis vel sesquipedalibus, pedicellis inferioribus 9-12 lin. superioribus 4-6 lin. longis, bracteis parvis lanceolatis. Perianthium campanulatum extus rubro tinctum 1½-2½ poll. longum, segmentis oblongis acutis. Ovarium cylindricum 6-12 lin. longum, stylis ligulatis quam ovarium 2-3plo brevioribus, stigmatibus emarginatis. Stamina ovario æquilongia vel longiora, post anthesin divergentia. Fructus siccus indehiscens oblongus 2-2½-pollicaris, 1 poll. diam., seminibus tenuibus. *Regiones littorales a Carolina boreali ad Floridam.*

Var. *MINOR*, *Carrière in Rev. Hort.* ix. 361; *Baker in Saund. Ref. Bot.* t. 319. Humilior, foliis strictis 12-18 poll. longis medio 15-18 lin. latis. Inflorescentia 3-4-pedalis, pedicellis brevibus, floribus 1½ poll. longis.

Var. *Y. SUPERBA*, *Haw. Suppl.* 14.—*Y. gloriosa*, *Andr. Bot. Rep.* t. 473, a typo recedit trunco altiore demum 10-pedali, foliis latis strictis, floribus majoribus, paniculæ ramis magis patulis.

Var. *PLICATA*, *Carrière in Rev. Hort.* ix. 359; *Engelm. Mon.* 39. Folia tenuiora sed stricta valde plicata 18-27 poll. longa 2-2½ poll. lata dorso scabrula. Panicula magna, floribus 2 poll. longis.

Var. *Y. RUFOCINCTA*, *Haw. Suppl.* 37, est forma subcaulis, foliis leviter recurvatis subglaucescentibus 2 poll. latis undique lævibus, margine rubro-brunneo magis perspicuo.

Var. *Y. OBLIQUA*, *Haw. Syn.* 69, est forma caulescens, foliis glaucis 1½-2 poll. latis oblique flexis.

Var. *Y. RECURVIFOLIA*, *Salisb. Parad.* t. 31; *Kunth, Enum.* iv. 272; *Baker in Saund. Ref. Bot.* t. 321.—*Y. recurva*, *Haw. Syn.* 69.—*Y. pendula*, *Siebold*; *Carrière in Rev. Hort.* viii. 488, t. 104.—*Y. japonica hort.* Caulis brevis sæpe ramosus. Folia 100-150 debiliora quam in typo 2-3-pedalia exteriora multum recurvata (juniora glauca) apice minus pungentia

media facie plana obscure plicata infra apicem et supra basin solum concava. Perianthii segmenta apice magis angustata.

Var. Y. ELLACOMBEI, *Baker in Ref. Bot.* t. 317. Subacaulis, foliis 40-50 substrictis 2-2½-pedalibus medio 18-21 lin. latis facie concavis diu glaucescentibus utrinque lævibus, perianthii segmentis acuminatis 2½-3 poll. longis, pedicellis inferioribus 12-18 lin. longis.

Var. Y. ACUMINATA, *Sweet, Brit. Flow. Gard.* t. 195; *Baker in Saund. Ref. Bot.* t. 316. Subacaulis, foliis 50-60 semipedalibus vel bipedalibus viridibus strictis acuminatis medio 18-21 lin. latis. Pedunculus foliis duplo brevior. Panicula minor quam in typo, floribus paucioribus 1½-2 poll. longis. Y. PATENS, *André in Ill. Hort.* 1870, 121, cum icone, est forma similis, foliis numerosioribus latioribus magis glaucescentibus.

Var. Y. TORTULATA, *Baker in Gard. Chron.* 1870, 1122. Acaulis, foliis circiter 40 strictis glaucescentibus 18-21 poll. longis medio 14-15 lin. latis sæpe oblique flexis.

Var. Y. PRUINOSA, *Baker in Gard. Chron.* 1870, 1122. Acaulis, foliis 70-80 strictis medio subplanis 2-2½-pedalibus medio 15-16 lin. latis glaucescentibus.

14. Y. TRECULEANA, *Carrière in Rev. Hort.* vii. (1858) 580, 1861, 305, 1863, 55, 1869, 406, fig. 82; *Baker in Gard. Chron.* 1870, 828; *Engelm. Monogr.* 41.—Y. aspera, *Réglé, Ind. Sem. Hort. Petrop.* 1858; *Gartenft.* 1859, 14.—Y. canaliculata, *Hook. in Bot. Mag.* t. 5201; *S. Wats. in Proc. Amer. Acad.* xiv. 252.—Y. longifolia, *Engelm.*; *Buckley in Proc. Phil. Acad.* 1862, 8.—Y. undulata, agavoides, cornuta, concava contorta, et revoluta hort. Caulis ad 20-25 pedes attingens, 1-2 pedum diam., copiose ramosus. Folia densa ensiformia 2-4½ pedes longa medio 2-3½ poll. supra basin 1 poll. lata coriacea obscure viridia utrinque scabra facie profunde concava dorso rotundata apice pungente, margine lato rubro-brunneo extus pallido primum deorsum obscure serrulato, vetustate interdum parce filifero. Pedunculus brevis. Panicula densa 2-4-pedalis, ramis glabris sæpe pedalibus, pedicellis inferioribus 15-18 lin. longis, bracteis albis pedicello æquilongis. Perianthium albidum campanulatum 1½-2½ poll. longum, segmentis oblongis acutis 5-6 lin. latis. Ovarium cylindricum 6 lin. longum, stylo crasso 1 lin. longo, stigmatibus quadratis emarginatis. Stamina ovario sæpe longiora, filamentis apice patulis. Fructus baccatus rostratus 3-4 poll. longus 1 poll. diam., seminibus 1½ lin. crassis. *Texas et Mexico borealis*, a Trécul et Karwinski versus annum 1850 introducta. Y. CANALICULATA, *Hook.*, est forma foliis subpedalibus profunde canaliculatis, floribus parvis.

15. Y. ANGUSTIFOLIA, *Pursh, Flora*, i. 227; *Sims in Bot. Mag.* t. 2236; *Haw. Suppl.* 35; *Kunth, Enum.* iv. 273; *Baker in Gard. Chron.* 1870, 923; *S. Wats. in Proc. Amer. Acad.* xiv. 253, non *Carrière*.—Y. angustifolia genuina, *Engelm. Monogr.* 50. Subacaulis. Folia 100 vel plura

densa rigida linearia sesquipedalia vel bipedalia supra basin deltoideam dilatam 3-4 lin. lata facie deorsum plana superne canaliculata a medio ad apicem pungentem sensim attenuata dorso subtriquetra margine pallide rubro-brunneo filis copiosis albidis tenuibus dejectis. Inflorescentia 3-4-pedalis, pedunculo subpedali, racemo terminali 30-40-floro interdum simplici, sæpe ad basin ramis paucis ascendentibus glabris 6-12-floris additis, pedicellis inferioribus 9-12 lin. longis, bracteis albis lanceolatis 6-12 lin. longis. Perianthium campanulatum, extus viridulum, segmentis oblongis acutis 2-2½ poll. longis medio 9-15 lin. latis. Ovarium oblongo-cylindricum 6-9 lin. longum, stylis quam ovarium duplo brevioribus, stigmatibus magnis viridibus emarginatis. Stamina pistillo paulo breviora, filamentis clavatis papillois post anthesin divergentibus. Capsula coriacea oblonga trisulcata breviter rostrata 2-3 poll. longa 12-15 lin. diam., seminibus nigris opacis ½ lin. crassis. *Missouri et Iowa ad Colorado et New Mexico*, Fendler 850! C. Wright 1810! Formam nanam habemus a Colorado foliis semipedalibus 1½-2 lin. latis ab apice ad basin canaliculatis. *Y. angustifolia* hortorum (e. gr. Garden, vol. viii. 134, icon) est sæpe forma *Y. filamentosa*.

Var. *Y. STRICTA*, Sims in *Bot. Mag.* t. 2222; Kunth, *Enum.* iv. 273; Reich. *Fl. Exot.* t. 201; Carrière in *Rev. Hort.* viii. 467, tab. 101-102; Baker in *Gard. Chron.* 1870, 293.—*Y. angustifolia*, var. *mollis*, Engelm. *Monogr.* 50; S. Wats. in *Proc. Amer. Acad.* xiv. 253. A typo recedit foliis minus rigidis apice minus pungentibus medio 6-9 lin. latis ad basin angustatis, inflorescentia magis composita, pedunculo 2-3-pedali. *Arkansas, Louisiana et Texas*, C. Wright 686! 1911! etc.

16. *Y. FILAMENTOSA*, Linn. *Sp.* 457 (Trew, *Ehret*, t. 37); *Bot. Mag.* t. 900; Red. *Lil.* t. 227, 228; Haw. *Suppl.* 34; Kunth, *Enum.* iv. 278; Carrière in *Rev. Hort.* ix. 212, figg. 47, 48; Engelm. *Monogr.* 51; Baker in *Saund. Ref. Bot.* t. 324. Acaulis vel subacaulis. Folia 30-50 dense rosulata ensiformia sesquipedalia vel bipedalia medio 1½-2 poll. lata firmula arundinacea recta obscure viridia leviter glaucescentia apice haud pungentia margine albida filis multis gracilibus albidis disintegratis. Inflorescentia 4-8-pedalis, pedunculo elongato, foliis reductis bracteato. Panicula rhomboidea, ramis flexuosis glabris vel puberulis ascendentibus semipedalibus, pedicellis cernuis 3-6 lin. longis, bracteis magnis scariosis lanceolatis. Perianthium album extus viridi tinctum 1½-2 poll. longum, segmentis oblongis vel oblongo-lanceolatis 6-9 lin. latis. Ovarium cylindricum 6-8 lin. longum, stylo angustiore duplo brevior quam ovarium, stigmatibus parvis quadratis emarginatis. Stamina ovario æquilonga vel longiore, filamentis post anthesin divergentibus. Fructus capsularis oblongus rostratus 1½-2 poll. longus, seminibus tenuibus. *Regiones littorales Americæ borealis a Maryland ad Floridam.*

Var. *MAXIMA*, Baker in *Ref. Bot.* t. 325, a typo recedit floribus 2½-3 poll. longis segmentis magis acuminatis. Forma adest foliis albo variegatis.

Var. Y. *CONCAVA*, *Haw. Suppl.* 34. A typo recedit foliis latioribus (3-4 poll. latis) erecto-incurvatis sesquipedalibus facie concavis.

Var. Y. *GLAUDESCENS*, *Haw. Suppl.* 35; *Sweet, Brit. Flow. Gard.* t. 53. A typo recedit foliis magis glaucis angustioribus 1 poll. latis, filis marginalibus rarioribus tenuioribus, panicularum rachibus dense griseo-pubescentibus, perianthii segmentis 15-16 lin. longis.

Var. Y. *PUBERULA*, *Haw. in Phil. Mag.* 1828, 186; *Sweet, Brit. Flow. Gard.* t. 21; *Baker in Saund. Ref. Bot.* t. 322. A typo recedit foliis deoilioribus magis recurvatis, paniculæ ramis pubescentibus, perianthii segmentis oblongo-lanceolatis 18-21 lin. longis.

Var. Y. *FLACCIDA*, *Haw. Suppl.* 34; *Carrière in Rev. Hort.* viii. 555, figg. 119, 120; *Lindl. Bot. Reg.* t. 1895; *Baker in Saund. Ref. Bot.* t. 323. A typo recedit foliis tenuioribus debilibus valde recurvatis, fibris marginalibus validioribus, paniculæ ramis pubescentibus, perianthii segmentis latis $1\frac{1}{2}$ poll. longis extus viridulis.

Var. *BRACTEATA*, *Engelm. Mon.* 52. Folia 50-100 sesquipedalia vel bipedalia 1- $1\frac{1}{2}$ poll. lata, filis marginalibus multis tenuibus. Pedunculus 4-6-pedalis foliis multis reductis magnis bracteatus, inferioribus 9-12 poll., superioribus 4-6 poll. longis. Panicula pedunculo duplo brevior. Perianthium 3 poll. longum, extus viridulum. Pistillum 15-16 lin. longum. Stamina pistillo duplo breviora. *Carolina australis*, formis reliquis magis serotina.

Var. *LÆVIGATA*, *Engelm. Monogr.* 52. Folia 25-50 firmiora longiora 30-40 poll. longa 10-15 lin. lata lævia saturate viridia apice pungentia ad basin valde angustata. Pedunculus 8-10-pedalis. Panicula pauciflora 4-5-pedalis. Flores sæpe geminati, perianthio 15-18 lin. longo subfœtido extus purpureo tincto. Stigmata profunde biloba.

Var. Y. *ANTWERPENSIS hort.*—Y. orchioides, var. major, *Baker in Bot. Mag.* t. 6316. Folia 12-20 erecto-patentia 12-15 poll. longa 1 poll. lata, filis marginalibus paucis tenuissimis brevissimis. Inflorescentia 2-3-pedalis, panicula pedali vel sesquipedali ramis 4-6 brevibus pubescentibus, perianthii segmentis 18-24 lin. longis.

Var. Y. *ORCHIOIDES*, *Carrière in Rev. Hort.* 1861, 369, figg. 89, 90. Forma valde depauperata, foliis 10-12 6-9 poll. longis 8-10 lin. latis filis marginalibus subnullis, pedunculo sesquipedali, racemo simplici quam pedunculus duplo brevior, perianthii segmentis ovatis 1 poll. longis.

17. Y. *FUNIFERA*, *Lemaire in Ill. Hort.* 1866 (xiii.), *Misc.* 99. Acaulis. Folia haud numerosa ensiformia 6-7-pedalia crassa rigida sordida viridia striolata margine filis robustis tenacibus sæpe 10-12 poll. longis prædita. *Mexico*, versus annum 1866 a Torrel introducta. Non vidi. An sit forma magna filifera *Y. Trecaleana*?

18. Y. *SCHOTTII*, *Engelm. Monogr.* 46; *S. Wats. in Proc. Amer. Acad.* xiv. 252.—Y. brevifolia, *Schott, MSS.*, non *Engelm.*—Y. puberula, *Torrey in Bot. Mex. Bound.* 221, non *Haw.* Caulis 2-5-pedalis sæpius a basi

ramosus. Folia crassa rigida recta linearia 9-10 poll. longa 6-8 lin. lata facie concava dorso convexa utrinque lævissima versus basin paulo angustata margine filis tenuissimis rectis prædita. Panicula elata laxiflora, pedunculo et ramis flexuosis sæpe puberulis. Perianthium pro genere parvum. Stylus brevis crassus. Filamenta apice demum patula. Fructus baccatus ovoideus 2 poll. longus breviter rostratus haud sulcatus, seminibus crassis. *Arizona australis*, Dr. Schott. (Non vidi.)

19. *Y. CONSTRICTA*, *Buckley in Proc. Philad. Acad.* 1862, 8?—*Y. angustifolia*, *Carrière in Rev. Hort.* ix. 20, t. 3, non *Pursh*.—*Y. polyphylla*, *Baker in Gard. Chron.* 1870, 1088.—*Y. albospica*, *Flore des Serres*, ser. ii. vol. vii. 110, fig. 1612.—*Y. angustifolia*, var. *radiosa*, *Engelm. in S. Wats. Bot. 40th Parall.* 496.—*Y. angustifolia*, var. *elata*, *Engelm. Mon.* 50; *S. Wats. in Proc. Amer. Acad.* xiv. 253. Caulis simplex ad 3-5 pedum longitudinem attingens. Folia 100-200 densa rigida linearia sesquipedalia vel bipedalia medio 6-8 lin. lata ad basin leviter angustata facie deorsum plana apice pungentia superne canaliculata, margine anguste rubro-brunneo filis multis tenuibus prædita. Inflorescentia 6-8-pedalis, pedunculo elongato Panicula deltoidea 3-4-pedalis, racemo terminali valido, ramis ascendentibus 6-9 poll. longis 10-15-floris, pedicellis 4-6 lin. longis. Perianthium 2 poll. longum, segmentis oblongis acutis. Ovarium oblongum, stylis quam ovarium subduplo brevioribus. Filamenta papillosa clavata pistillo breviora demum apice divergentia. Fructus capsularis coriaceus 2-3-pollicaris, seminibus tenuibus. *Utah et Arizona ad Mexico borealem*.

20. *Y. BACCATA*, *Torrey, Bot. Mex. Bound.* 221; *Engelm. Monogr.* 44; *André in Rev. Hort.* n. s. t. 115; *S. Wats. in Proc. Amer. Acad.* xiv. 252.—*Y. californica*, *Nuttall herb.*! Acaulis vel breviter caulescens, interdum 8-10-pedalis. Folia ensiformia crassa rigidissima 1½-3-pedalia medio 1-2 poll. supra basin 9-12 lin. lata facie leviter concava utrinque scabra apice pungentia, margine rubro-brunneo filis copiosis validissimis squarrosis disintegratis. Inflorescentia 5-6-pedalis, pedunculo elongato, ramis semipedalibus sæpissime glabris, bracteis magnis lanceolatis. Perianthium 2-3 poll. longum, segmentis oblongo-lanceolatis 6-9 lin. latis. Ovarium cylindricum 7-8 lin. longum, stylo elongato cylindrico. Stamina ovario longiora, filamentis post anthesin divergentibus. Fructus ovoideus vel oblongus baccatus purpureus edulis 3-5-pollicaris 1½ poll. diam., seminibus crassis. *Colorado, Texas, California australis, Mexico borealis*, Fendler 849! etc.

Var. *AUSTRALIS*, *Engelm. loc. cit.*—*Y. filifera*, *Chabaud in Rev. Hort.* 1876, 432, fig. 97. Arborecens, interdum 50-pedalis, trunco 2-3 ped. diam., foliis sesquipedalibus obscure viridibus medio leviter canaliculatis 12-15 lin. latis, fibris marginalibus tenuioribus, inflorescentia 6-8-pedali, pedunculo brevi, ramis interdum bipedalibus. *Mexico*, a Roehl in hortos introducta.

Var. *Y. PERICULOSA*, *Baker in Gard. Chron.* 1870, 1088. Folia stricta

2½-3 pedalia medio 8-9 lin. lata a basi ad apicem canaliculata dimidio superiore filis copiosis squarrosis circinatis prædita. Flores ignoti.

Var. Y. CIRCINATA, *Baker, loc. cit.* Folia 2-2½-pedalia minus stricta medio 5-6 lin. lata filis copiosis spiraliter circinatis prædita. Flores ignoti.

Var. HYSTRIX, *Baker.* Folia dura strictissima subpedalia medio 6-7 lin. lata a basi ad apicem concava, filis marginalibus copiosis spiralibus. Flores ignoti.

Var. Y. SCABRIFOLIA, *Baker, l. c.* Truncus humilior gracilior. Folia minus stricta et fragiliora exteriora recurvata sesquipedalia vel bipedalia medio 4-5 lin. lata facie canaliculata lævia nitide saturate viridia medio pallidiora dorso a basi ad apicem rotundatum scabra, filis marginalibus tenuioribus arcuatis haud circinatis. Flores ignoti.

Var. Y. FRAGILIFOLIA, *Baker, l. c.* Truncus brevis gracilis. Folia minus stricta et fragiliora exteriora recurvata sesquipedalia medio 6-7 lin. lata, margine superne solum filis paucis tenuibus brevibus arcuatis instructo. Flores ignoti.

21. Y. WHIPPLEI, *Torrey, Bot. Mex. Bound.* 221; *Engelm. Monogr.* 54; *Baker in Gard. Chron.* 1876, ii. 196, fig. 42; *S. Wats. in Proc. Amer. Acad.* xiv. 254.—Y. aloifolia, *Torrey, Pacif. R. Rep.* iv. 147.—Y. californica, *Lemaire in Ill. Hort.* 1813, sub t. 372.—Y. graminifolia, *Wood in Proc. Phil. Acad.* 1868, 167. Acaulis vel subacaulis stolonifera. Folia 150-200 densa rigida stricta linearis pedalia vel sesquipedalia medio 4-6 lin. lata deorsum haud attenuata viridia leviter glauco tincta basi dilatata deltoidea facie deorsum plana dorso canaliculata subtriquetra apice canaliculata pungentia, margine pallido minute serrulato. Inflorescentia 4-12-pedalis. Pedunculus elongatus, foliis reductis pluribus bracteatus. Panicula densa oblongo-lanceolata, ramis gracilibus semipedalibus, pedicellis ascendentibus 12-18 lin. longis, bracteis minutis albis linearibus. Perianthium album extus viridi tinctum 15-21 lin. longum, segmentis lanceolatis medio 3-6 lin. latis. Filamenta subulata vix clavata haud papillosa 4-6 lin. longa alte perigyna flore expanso cum perianthii segmentis patula. Ovarium oblongum 4 lin. longum profunde 6-sulcatum; stylus gracilis 1 lin. longus, stigmatibus capitato obscure trilobato papillis albis crystallinis incrustato. Fructus coriaceus demum loculicido-trivalvis oblongus 6-sulcatus 1-2 poll. longus, 1 poll. diam., seminibus nigris ½ lin. crassis. *California et Arizona.* Y. GRAMINIFOLIA, *Wood*, est forma foliis bipedalibus 3-4 lin. latis minus rigidis recurvatis. Inter *Euyuccam* et *Hesperaloem* medium tenens, perianthio prioris cum pistillo posterioris conjuncto.

Species exclusæ.

Y. SPINOSA, *H. B. K. Nov. Gen.* i. 289, est species spuria ex floribus *Yuccæ* cum folio *Dasyliirionis crotrichia* commixtis facta.

Y. ACAULIS, H. B. K. *loc. cit.* Flores *Yuccæ*; folia *Agaves* vel *Fourcroyæ*?

6. HESPERALOE, *Engelm.*

Engelm. in S. Wats. Bot. 40th Parall. 497; S. Wats. in Proc. Amer. Acad. xiv. 219.—*Aloes et Yuccæ* sp., *auct.*

Perianthium polyphyllum cylindricum albidum extus rubro tinctum, segmentis subconformibus lanceolatis venulis 5–6 in tertiam partem centram congestis. *Stamina* 6 perianthio paulo breviora, filamentis obscure perigynis lineari-subulatis, antheris parvis lanceolatis versatilibus introrsis basi sagittatis. *Ovarium* sessile ampullæforme triloculare, ovulis in loculo crebris horizontalibus; stylus elongatus filiformis, stigmatem parvo capitato obscure trilobato. *Capsula* coriacea subglobosa septicide trivalvis, carpellis demum dorso dehiscentibus, seminibus multis discoideis, testa nigra, albumine firmo, embryone axili. Flores *Ornithogali*, cum habitu omnino *Yuccæ filiferæ*.

1. H. YUCCÆFOLIA, *Engelm. loc. cit.*; *S. Wats. in Proc. Amer. Acad. xiv. 250.*—*Yucca*? *parviflora*, *Torrey in Bot. Mex. Bound. 221; Baker in Gard. Chron. 1870, 923.*—*Aloe yuccæfolia*, *A. Gr. in Proc. Amer. Acad. vii. 390.* Caulis 2–4-pedalis interdum ramosus. Folia dense rosulata lineari-subulata rigida arcuata sesquipedalia vel bipedalia basi 5–6 lin. lata ad apicem pungentem sensim angustata facie profunde canaliculata, marginibus filis copiosis validis brevibus squaroso-circinatis præditis. Pedunculus gracilis 2–3-pedalis foliis 1–2 reductis instructus. Inflorescentia racemosa vel parce paniculata; racemi pedales et ultra inferne laxi, bracteis lanceolatis membranaceis, pedicellis 5–6nis ascendentibus apice articulatis, floriferis 3–6 lin., fructiferis 9–12 lin. longis. *Perianthium* 9–12 lin. longum, segmentis 1–1½ lin. latis. *Antheræ* 1 lin. longæ. Stylus demum exsertus ovario 2–3plo longior. *Capsula* subpollicaris. *Texas occidentalis*, C. Wright 1908! H. ENGELMANNI, *Krauskopf*, est forma stylo incluso, antheris majoribus, ramis gracilioribus magis flexuosis, bracteis minoribus.

7. HERRERIA, *Ruiz & Pavon.*

Ruiz & Pavon, Fl. Peruv. iii. 70, t. 303; Endl. Gen. No. 1195; Griseb. in Fl. Bras. iii. 64. t. 4–5; Kunth, Enum. v. 291.—*Salsa, Feuillé.*

Flores hermaphroditi. *Perianthium* viridulum campanulatum, segmentis subconformibus oblongis vel lineari-oblongis dorso 3–5-nerviis, flore expanso falcatis. *Stamina* 6 profunde perigyna

perianthio paulo breviora, filamentis filiformibus, antheris lineari-oblongis versatilibus introrsis. *Ovarium* sessile ovoideum trilobulatum, ovulis in loculo paucis superpositis; *stylus* brevis cylindricus, stigmatibus capitatis. *Capsula* globosa coriacea profunde lobata loculicide trivalvis, seminibus paucis discoideis alatis, testa membranacea brunnea, albumine firmo, embryone axili. *Frutices volubiles habitu* Dioscoreæ et Smilacis, *caulibus sæpe aculeatis, foliis ad ramorum latera rosulatis linearibus vel lanceolatis distincte multinerviatis deorsum costatis, ramulis floriferis simpliciter racemosis vel paniculatis, bracteis minutis membranaceis persistentibus, pedicellis medio articulatis.*

Folia papyracea.

Folia lanceolata, venis 20–25..... 1. *H. Salsaparilha.*

Folia linearia, venis 10–15 2. *H. montevidensis.*

Folia rigida linearia, venis 9–13 3. *H. stellata.*

1. *H. SALSAPARILHA*, *Mart. Iter*, ii. 545; *Schultes, Syst. Veg.* vii. 363; *Griseb. Fl. Bras.* iii. 23, t. 4, 5; *Kunth, Enum.* v. 294.—*H. parviflora*, *Lindl. Bot. Reg.* t. 1042.—*Rajania verticillata*, *Vell. Fl. Flum.* x. t. 115. Late volubilis, ramis sæpe aculeatis. Folia lanceolata papyracea glabra 4–9 poll. longa medio 6–12 lin. lata ad apicem et basin angustata venis 20–25 distinctis percursa. Rami floriferi 2–8 poll. longi simplices vel paniculati foliis productis haud præditi, bracteis minutis deltoideis membranaceis, pedicellis 2–3nis 2–3 lin. longis. Perianthium 3–4 lin. longum, segmentis lineari-oblongis. Fructus coriaceus, profunde lobatus, 4 lin. longus 6 lin. diam. *Brasilia centralis et meridionalis*, Burchell 1687! 5001! 8189! 8160! Vauthier 149! etc.

VAR. *H. INTERRUPTA*, *Griseb. in Fl. Bras.* iii. 24; *Kunth, Enum.* v. 293. Folia minora 2–4 poll. longa 6–8 lin. lata. Racemi stricti simplices foliis longiores, rachi hispidula, floribus per 4–6 fasciculatis. Perianthium 2 lin. longum, segmentis oblongis. *Brasilia meridionalis.*

2. *H. MONTEVIDENSIS*, *Klotzsch; Griseb. in Flor. Bras.* iii. 24; *Kunth, Enum.* v. 293. Rami graciles inermes. Folia papyracea glabra linearia 2–3 poll. longa medio 2–4 lin. lata venis 10–15 percursa. Rami simplices 2–6 poll. longi foliis productis haud præditi, bracteis minutis deltoideis, pedicellis 1–4nis 1–2 lin. longis. Perianthium $1\frac{1}{2}$ –2 lin. longum, segmentis oblongis. Capsulam non vidi. *Uruguay*, Sello! Fox 344! Tweedie 745! etc.

3. *H. STELLATA*, *Ruiz & Pavon, Fl. Peruv.* iii. 70. t. 303; *Kunth, Enum.* v. 291.—*H. verticillata*, *Molina, Sagg. Chili*, edit. ii. 136. Rami sæpe aculeati. Folia rigida linearia 2–3 poll. longa medio 2–3 lin. lata venis exsculptis 9–13 percursa. Rami floriferi elongati sæpissime panicu-

lati nodis inferioribus foliis productis bracteati, bracteis propriis minutis deltoideis, pedicellis 1-3nis 3-4 lin. longis. Perianthium $2\frac{1}{2}$ -3 lin. longum, segmentis lanceolatis. Capsula orbicularis 4-6 lin. longa apice emarginata, valvis conspicue lineatis. *Chili*, Pavon! Cuming 850! C. Gay! etc. Plantæ affinis exempla haud florifera adsunt in Herb. Kew. a Tweedie ad Passagrande in ditone Uruguay lecta, foliis firmis anguste linearibus $\frac{1}{2}$ -1 $\frac{1}{2}$ poll. longis $\frac{1}{2}$ - $\frac{1}{2}$ lin. latis venis 5-7 crebris exsculptis percursis.

8. BEAUCARNEA, *Lemaire*.

Lemaire, *Ill. Hort.* viii. *Misc.* 59, cum iconè; *Baker in Trimen's Journ.* 1872, 323.—*Dasylyrion*, *Zucc. et Kunth*, ex parte.—*Roulinia*, *A. Brongn.* ex parte.—*Nolina*, *S. Wats. in Proc. Amer. Acad.* xiv. 218, 264, ex parte.—*Yuccæ* sp., *Karw.*—*Cordylines* sp., *H. B. K.*

Flores polygamo-dioici. *MASC.* *Perianthium* parvum campanulatum 6-partitum, segmentis oblongis conformibus. *Stamina* 6 profunde perigyna, filamentis subulatis perianthio brevioribus, antheris oblongis introrsis versatilibus. *Ovarium* rudimentarium. *FÆM.* *Perianthium* omnino maris. *Stamina* rudimentaria. *Ovarium* 3-loculare, ovulis in loculo 2 erectis collateralibus; *stylus* brevissimus, stigmate tricuspido. *Capsula* trilocularis membranacea subgloboso-triquetra profunde trilobata, angulis sæpe alatis, loculis sæpe ante seminis maturationem irregulariter disruptis. *Semina* subglobosa in loculo solitaria, testa tenui, albumine corneo, embryone axili. *Frutices vel arbores americanæ, trunco vario interdum subnullo, foliis siccis linearibus acuminatis persistentibus dense rosulatis margine scabris nunquam spinoso-dentatis, floribus copiosis minutis laxè paniculatis, bracteis floriferis membranaceis persistentibus, pedicellis apice articulatis.*

Folia pro genere lata.

Paniculæ rami elongati.

1. *B. longifolia.*

2. *B. recurvata.*

3. *B. parviflora.*

4. *B. Bigelovii.*

Paniculæ rami breves..... 5. *B. Palmeri.*

Folia anguste linearia.

Folia apice in setas dissoluta.

6. *B. erumpens.*

7. *B. microcarpa.*

Folia apice integra.

Fructus magnus papyraceus.

8. *B. Lindheimeriana.*

9. *B. Watsoni.*

Fructus parvus cite disruptus.

10. *B. texana*.

11. *B. humilis*.

Fructus ignotus 12. *B. Hartwegiana*.

1. *B. LONGIFOLIA*, *Baker in Trimen's Journ.* 1872, 324.—*Dasyliirion longifolium*, *Zucc. et Karw. in Pl. Nov. Hort. Monac.* iv. 224, tab. i. fig. 2 (fructus); *Morren in Hort. Belg.* xv. (1865) 321, t. 20, 21; *Rev. Hort.* 1876, fig. 100; *Gard. Chron.* 1877, 493, fig. 73, 567, fig. 90.—*Yucca longifolia*, *Karw. in Schultes fil. Syst.* vii. 715.—*Roulinia Karwinskiana*, *A. Brongn. in Ann. Sc. Nat.* ser. 2, xiv. 319. Truncus in hortis interdum 4–6-pedalis, diametro sub foliorum corona semipedali, basi vix tuberosa. Folia 100–200 valde recurvata linearia viridia 4–6-pedalia deorsum 9–15 lin. lata a medio ad apicem scariosum integrum sensim angustata margine scabra, venis crebris perspicuis 50–60. Inflorescentia 5–6-pedalis, pedunculo brevissimo, ramis ascendentibus decompositis interdum pedalibus, bracteis floriferis lanceolatis, pedicellis aggregatis perianthio interdum longioribus. Perianthium $1\frac{1}{2}$ lin. longum. Fructus orbicularis 4–5 lin. longus apice emarginatus, angulis late alatis. *Mexico*, *Karwinski* etc. Forma adest (*B. longifolia glauca hort.*) foliis angustioribus glauco tinctis.

2. *B. RECURVATA*, *Lemaire in Ill. Hort.* viii. *Misc.* 59, cum icone; *Gard. Chron.* 1870, 1445, fig. 244; *Flore des Serres*, xviii. *Misc.* 26, cum icone; *Baker in Trimen's Journ.* 1872, 325.—*Pincenicitia tuberculata hort.* Truncus in hortis interdum 5–6-pedalis, diametro sub foliorum corona 2–3-pollicari, basi valde tuberosa pedali et ultra. Folia 100 vel ultra valde recurvata linearia 3–4-pedalia medio 8–9 lin. lata ad basin æquilata viridia venis crebris subtilibus 40–50 margine scabra apice integra longe acuminata. Inflorescentia 3–4-pedalis, pedunculo brevissimo, ramis ascendentibus decompositis semipedalibus, bracteis lanceolatis, pedicellis floriferis $1\frac{1}{2}$ –2 lin. longis. Perianthium $1\frac{1}{2}$ lin. longum. Fructus orbicularis 4–5 lin. diam., apice et basi emarginatus, angulis late alatis. *Mexico*, versus annum 1845 introducta.

Var. *B. INTERMEDIA*, *hort.*, a typo recedit foliis brevioribus minus recurvatis.

Var. *B. RUBRA*, *hort.*, est forma foliis prope basin rubro tinctis.

Var. *B. STRICTA*, *Lemaire, loc. cit.*—*Pincenicitia glauca hort.* Folia breviora angustiora (2–3-pedalia, medio 5–6 lin. lata) glauca venis magis exsculptis. *Mexico ad Santa Fe*, *Hahn* 520! et *Montes Guadalupe*, *Bourgeau*!

3. *B. PARVIFLORA*, *Baker in Trimen's Journ.* 1872, 328.—*Cordylina parviflora*, *H. B. K. Nov. Gen.* i. 269. t. 674.—*Dracæna parviflora*, *Willd.*; *Schultes fil. Syst. Veg.* vii. 348.—*Dasyliirion Humboldtii*, *Kunth, Enum.* v.

42.—*Roulinia Humboldtiana*, *A. Brong. loc. cit.* Truncus 1–2-orgyalis. Folia pro genere verisimiliter lata. Panicula subdensa 1–2-pedalis, ramis ascendentibus decompositis 3–4 poll. longis foliis reductis elongatis basi valde dilatatis 1 poll. latis bracteatis, bracteis floriferis lanceolatis integris 3–4 lin. longis, pedicellis brevissimis aggregatis. Perianthium 1 lin. longum. Fructus ignotus. *Mexico in alta planitie*, Humboldt. (Non vidi.)

4. *B. BIGELOVII*, *Baker in Trimen's Journ.* 1872, 326.—*Dasyllirion Bigelovii*, *Torrey in Bot. Whipple*, 95 (151).—*Nolina Bigelovii*, *S. Wats. in Proc. Amer. Acad.* xiv. 247. Truncus ignotus. Folia crassa stricta plana 3–4-pedalia supra basin dilatata 10–12 lin. lata ad apicem sensim angustata venis perspicuis crebris 50 vel ultra, margine corneo rubello integro. Pedunculus tripedalis. Paniculæ rami inferiores 6–8 poll. longi sessiles, ramis multis ascendentibus simplicibus 1–2 poll. longis. Bracteæ floriferæ minutæ deltoideæ. Pedicelli solitarii vel gemini, fructiferi $1\frac{1}{2}$ lin. longi. Perianthium ignotum. Fructus orbicularis 5–6 lin. latus apice et basi emarginatus angulis late alatis. *Arizona occidentalis*, Dr. Bigelow! Plantam affinem imperfecte cognitam a Schott in Sonora lectam a *Torrey in Bot. Mex. Bound.* 216 memoratam “trunco 6-pedali diam. 2–3-pedali, foliis 3–5-pedalibus planis medio circiter pollicem latis margine scabrilis interdum filiferis, inflorescentia 6–8-pedali, paniculæ ramis pedaliibus vel sesquipedalibus, fructu papyraceo,” non vidi. *N. PARRY*, *S. Wats. l. c.*, a deserto San Bernardino Californiæ, *Parry*, trunco 3–6-pedali, a typo recedit foliis crassioribus superne subconcavis margine scaberrimis, paniculæ ramis pedicellisque robustioribus.

5. *B. PALMERI*, *Baker*.—*Nolina Palmeri*, *S. Wats. in Proc. Amer. Acad.* xiv. 248. Folia verisimiliter plana pro genere lata margine scaberrima. Panicula angusta tripedalis, ramis 2–3 poll., ramulis 1 poll. longis. Fructus specierum omnium minimus 2 lin. diam., loculis ante seminis maturationem ruptis. Pedicelli fructiferi 2 lin. longi. *California inferior ad montes Tantillas*, Palmer. (Non vidi.)

6. *B. ERUMPENS*, *Baker in Trimen's Journ.* 1872, 326.—*Dasyllirion erumpens*, *Torrey, Bot. Mex. Bound.* 216.—*Nolina erumpens*, *S. Wats. in Proc. Amer. Acad.* xiv. 248. Truncus 2–5-pedalis. Folia stricta rigida 2–3-pedalia supra basin 5–6 lin. lata facie canaliculata dorso rotundata apice acuminata in setas dissoluta margine scaberrima. Paniculæ rami inferiores semipedales deltoidei, ramulis multis ascendentibus densifloris inferioribus 2–3 poll. longis simplicibus vel pinnatis, bracteis minutis deltoideis, pedicellis floriferis $\frac{1}{2}$ –1 lin. longis. Perianthium 1 lin. longum. Ovarium suborbiculare vel obovoideum apice emarginatum, angulis anguste alatis. Fructus parvus, angulis vix alatis, loculis ante seminis maturationem ruptis. *Texas occidentalis*, C. Wright 1918!

7. *B. MICROCARPA*, *Baker*.—*Nolina microcarpa*, *S. Wats. in Proc. Amer. Acad.* xiv. 247. Truncus brevis. Folia rigida stricta linearia supra basin 4-6 lata facie concava dorso convexa apice in setas dissoluta margine scaberrima. Inflorescentia 6-pedalis, pedunculo valido, paniculæ ramis pedalis, ramulis ascendentibus 2-3 poll. longis. Fructus papyraceus 3 lin. diam., loculis haud ruptis, pedicello gracillimo 2-3 lin. longo. *Arizona australis*, Rothrock 278. (Non vidi.)

8. *B. LINDHEIMERIANA*, *Baker in Trimen's Journ.* 1872, 328.—*Dasy-lirion Lindheimerianum*, *Scheele in Linnæa*, xxv. 262.—*D. tenuifolium*, *Torrey, Bot. Mex. Bound.* 216.—*Nolina Lindheimeriana*, *S. Wats. in Proc. Amer. Acad.* xiv. 247. Truncus brevissimus. Folia ad rosulam 15-20 anguste linearia 2-3-pedalia supra basin 3-4 lin. lata leviter concava venis crebris 20-25 apice integra longe acuminata margine scabrida. Inflorescentia 2-4-pedalis, pedunculo elongato foliis multis erectis longe acuminatis prædito. Panicula rhomboidea pedalis vel sesquipedalis, ramis multiis simplicibus 1-6 poll. longis, bracteis floriferis minutis deltoideis, pedicellis 2-5nis, floriferis $\frac{1}{2}$ -1 lin. longis. Perianthium 1 lin. longum. Fructus suborbicularis papyraceus 4-5 lin. diam., apice et basi emarginatus, loculis late alatis, pedicello cernuo 2-3 lin. longo. *Texas*, Lindheimer 551! 552! *C. Wright* 693! 1919!

9. *B. WATSONI*, *Baker*.—*Nolina humilis*, *S. Wats. in Proc. Amer. Acad.* xiv. 248, *ex parte*. Truncus brevissimus. Folia ad rosulam 10-12 anguste linearia sesquipedalia vel bipedalia supra basin 2-2 $\frac{1}{2}$ lin. lata facie concava venis 10-12 perspicuis apice integra acuminata margine scabra. Inflorescentia semipedalis, pedunculo brevissimo, ramis densis ascendentibus sessilibus simplicibus 1-3 poll. longis, bracteis floriferis lanceolatis acuminatis albis membranaceis 3-4 lin. longis. Perianthium 1 lin. longum. Fructus orbicularis papyraceus 4-4 $\frac{1}{2}$ lin. diam., loculis haud ruptis dorso late alatis, pedicello cernuo 2-2 $\frac{1}{2}$ lin. longo. *Mexico in ditione San Luis Potosi*, alt. 6000-8000 *pedum*, Parry & Palmer 874!

10. *B. TEXANA*, *Baker*.—*Nolina texana*, *S. Wats. in Proc. Amer. Acad.* xiv. 248.—*B. Hartwegiana*, *Baker in Trimen's Journ.* 1872, 327, *ex parte*. Truncus brevissimus, foliorum cæspitibus pluribus. Folia ad cæspitem 10-15 anguste linearia 1-4-pedalia supra basin 1 $\frac{1}{2}$ -2 lin. lata facie concava venis 6-8 perspicuis percursa dorso rotundata apice integra acuminata margine scabra. Inflorescentia 1-2-pedalis, pedunculo brevi, interdum subnullo. Panicula rhomboidea semipedalis vel pedalis, ramis ascendentibus compositis inferioribus 3-4 poll. longis foliis longe acuminatis bracteis, bracteis floriferis membranaceis lanceolatis acuminatis 2-4 lin. longis, pedicellis 1-2nis $\frac{1}{2}$ -1 $\frac{1}{2}$ lin. longis. Perianthium 1-1 $\frac{1}{2}$ lin. longum. Fructus 2-3 lin. diam. membranaceus, loculis ante seminis maturationem ruptis dorso haud alatis, semine globoso 2 lin. crasso, pedicello 2-3 lin. longo. *Texas*, *C. Wright* 692! Lindheimer 550! 712!

11. *B. HUMILIS*, Baker.—*Nolina humilis*, *S. Wats. in Proc. Amer. Acad.* xiv. 248, *ex parte*. Truncus brevissimus. Folia ad rosulam 10–12 anguste linearia sesquipedalia supra basin 2 lin. lata facie concava venis 7–9 percursa dorso rotundata apice integra acuminata margine scabra. Panicula subsessilis semipedalis, ramis paucis strictis ascendentibus simplicibus 1–2 poll. longis, bracteis floriferis membranaceis lanceolato-delloideis integris $1\frac{1}{2}$ –2 lin. longis, pedicellis solitariis floriferis brevissimis. Perianthium 1 lin. longum. Fructus parvus, loculis haud alatis cite disruptis, semine subgloboso $2\frac{1}{2}$ lin. diam., pedicello $1\frac{1}{2}$ –2 lin. longo. *Mexico in ditione San Luis Potosi, alt. 6000–8000 pedum, Parry & Palmer 875!*

12. *B. HARTWEGIANA*, Baker in *Trimen's Journ.* 1872, 327, *ex parte*.—*Dasylium Hartwegianum*, *Zucc. in Pl. Nov. Hort. Monac.* v. 22.—*D. junceum*, *Zucc. loc. cit.* v. 19?—*Roulinia longifolia*, *A. Brongn. loc. cit.*—*Cordyline longifolia*, *Benth. Fl. Hartweg.* 53.—*Beaucarnea gracilis*, *Lemaire, Ill. Hort.* viii. *Misc.* 61? Truncus? Folia anguste linearia bipedalia supra basin 2 lin. lata facie concava venis 7–9 percursa dorso rotundata apice longe acuminata integra margine scabra. Inflorescentia pedalis vel sesquipedalis, pedunculo brevissimo. Panicula rhomboidea, ramis inferioribus compositis 4–6 poll. longis foliis subulatis pedalibus basi dilatatis bracteatis, bracteis floriferis membranaceis deltoideo-cuspidatis 1– $1\frac{1}{2}$ lin. longis, pedicellis 1–2nis 1– $1\frac{1}{2}$ lin. longis. Perianthium 1 lin. longum. Fructus ignotus. *Mexico ad Zacatecas, Hartweg 406!*

9. DASYLIBION, Zucc.

Zucc. in Plant. Nov. Hort. Monac. fasc. iv. 221, v. 19, *ex parte*; *Kunth, Enum.* v. 38, *ex parte*; *K. Koch in Hort. Belg.* xv. 325, *ex parte*; *Baker in Trimen's Journ.* 1872, 296; *S. Wats. in Proc. Amer. Acad.* xiv. 249.—*Roulinia*, *A. Brong. in Ann. Sc. Nat.* ser. 2, xiv. 319, *ex parte, non Decaisne*.—*Yuccæ* sp., *Schiede*.—*Anatis, Moc. et Sessé*.

Flores polygamo-dioici. *MASC.* *Perianthium* parvum campanulatum 6-partitum, segmentis 6 obovato-oblongis obtusis subconformibus diu ascendentibus. *Stamina* 6 profunde perigyna exserta, filamentis subulatis, antheris oblongis versatilibus. *Ovarium* rudimentarium. *FÆM.* *Perianthium* omnino maris. *Stamina* rudimentaria. *Ovarium* sessile uniloculare, ovulis in loculo paucis erectis; *stylus* brevis erectus subulatus, stigmatē tricuspido. *Fructus* siccus indehiscens triqueter, angulis sæpissime alatis, semine solitario ovoideo erecto, testa tenui membranacea, albumine firmo, embryone cylindrico axili. *Frutices vel arbores*

*Americanae, trunco valido sæpissime brevi simplici, foliis dense ro-
sulatis duris augustis elongatis sæpissime spinoso-dentatis apice in
setas dissolutis, pedunculo foliis siccis lanceolatis bracteato, flori-
bus sæpissime in paniculas elongatas ramis densifloris racemosis
dispositis, bracteis parvis membranaceis persistentibus, pedicellis
brevisimis apice articulatis, floribus parvis albidis.*

Folia margine spinoso-dentata.

Raceni breves densiflori. Panicula angustata, bracteis prima-
riis magnis.

Folia apice in setas dissoluta.

1. *D. graminifolium.*

2. *D. texanum.*

3. *D. Wheeleri.*

4. *D. acrotrichum.*

Folia apice integra 5. *D. glaucophyllum.*

Racemi elongati laxiflori 6. *D. serratifolium.*

Folia ignota 7. *D. Berlandieri.*

Folia integra

Folia late linearia 8. *D. pliabile.*

Folia anguste linearia 9. *D. Hookeri.*

Folia quadrangulata 10. *D. quadrangulatum.*

1. *D. GRAMINIFOLIUM, Zuccar. in Plant. Nov. Hort. Monac. fasc. iv. 225, fig. 1; Kunth in Otto & Dietr. Allg. Gartenzeit. 1841, 121, tab. 1, Enum. v. 39; Baker in Trimen's Journ. 1872, 297, ex parte.*—*Yucca graminifolia, Zucc. in Cat. Hort. Monac. 1837.* Truncus brevissimus. Rosula foliorum 4–5 ped. diam. Folia densissima linearia 3–4-pedalia supra basin dilatata 6–7 lin. lata læte viridula subnitidula longe acuminata apice in setas squarrosas 6–8 dissoluta margine aculeis curvatis corneis flavidis $\frac{1}{2}$ –1 lin. longis armata inter dentes serrulata. Inflorescentia 8–9-pedalis. Panicula angusta pedunculo æquilonga, racemis inferioribus densissimis 3–5nis, centralibus distincte pedunculatis $1\frac{1}{2}$ –2 poll. longis, masculis expansis oblongis 5–6 lin. diam., bracteis late ovatis laceratis. Perianthium masculum albidum 1 lin. longum, staminibus exsertis. Fructus ignotus. *Mexico, versus annum 1835 in hortis introducta. (Non vidi.)*

2. *D. TEXANUM, Scheele in Linnæa, xxiii. 140; Walp. Ann. iii. 644; S. Wats. in Proc. Amer. Acad. xiv. 249.*—*D. graminifolium, Baker in Trimen's Journ. 1872, 247, ex parte.* Truncus simplex 2–5-pedalis. Folia densissima linearia 3–4-pedalia supra basin dilatata 5–6 lin. lata læte viridula longe acuminata apice in setas squarrosas dissoluta margine aculeis curvatis corneis flavidis $\frac{1}{2}$ –1 lin. longis armata inter dentes serrulata. Inflorescentia 8–10-pedalis. Panicula angusta 2–3-pedalis, racemis densissimis, inferioribus sæpe 7–9nis congestis subsessilibus, centralibus 1–2 poll. longis, masculis expansis 4 lin. diam., bracteis late ovatis 1 lin. longis albis

membranaceis copiose dentatis. Perianthium masculum 1 lin. longum, staminibus exsertis. Fructus late ellipticus 3-3½ lin. longus apice haud emarginatus, alis superne 1 lin. latis ad stylum adnatis. *Texas et New Mexico*, C. Wright 694! Lindheimer 548! 549! etc. An a *D. graminifolia* specificè distinguenda?

3. *D. WHEELERI*, *S. Wats. in Proc. Amer. Acad.* xiv. 249. 12-14-pedalis, habitu *D. texani*. Folia linearia supra basin 7-9 lin. lata, aculeis apice brunneis. Racemi eis *D. texani* longiores (2-4 poll. longi) flexuosi sæpe penduli. Fructus obovoideus albidus 4 lin. longus 3 lin. diam., apice emarginatus alis superne latioribus ad stylum haud adnatis. *Arizona et New Mexico*, Rothrock 329, 655 etc. (Fructum tantum vidi.)

4. *D. ACROTRICHUM*, *Zucc. Pl. Nov. Hort. Monac. fasc. iv. tab. 1. fig. 4; Kunth, Enum. v. 40; Hook. in Bot. Mag. t. 5030; Flore des Serres, t. 1448; Baker in Trimen's Journ. 1872, 297.*—*Yucca acrotricha*, *Schiede in Schultes fil. Syst. Veg. vii. 176.*—*Roulinia acrotricha*, *A. Brong. in Ann. Sc. Nat. ser. 2, xiv. 320.*—*D. gracile*, *Zucc. in Pl. Nov. Hort. Monac. v. 22; C. Martens in Ann. Soc. Hortic. Hérault, 1866, cum icone.*—*Roulinia gracilis*, *A. Brong. loc. cit.*—*Barbacenia gracilis et Bonapartea gracilis hort.* Truncus validus simplex in hortis nostris interdum 4-5-pedalis. Folia densissima 200 vel plura exteriora recurvata linearia 2-3-pedalia supra basin dilatata 6-8 lin. lata pallide viridia vix glauco tincta apice in fibras 20-30 dissoluta margine aculeis flavidis lanceolatis corneis uncinatis pungentibus ¼-1 lin. longis armata inter dentes distincte serrulata. Inflorescentia 8-10-pedalis. Panicula densa cylindrica 4-5-pedalis, racemis inferioribus 5-7nis centralibus 2-4 poll. longis distincte pedunculatis, masculis expansis 5-6 lin. crassis, bracteis ovatis 1 lin. longis subintegris. Perianthium masculum 1 lin. longum, segmentis obovato-oblongis obtusis, antheris exsertis. Fructus obovoideus 4 lin. longus apice emarginatus, alis superne latioribus ad stylum haud adnatis. *Mexico*, *Schiede* (Cerro de la Ventana, anno 1829), *Repper!* etc. Vidi exemplum in herb. DC. anno 1813 in hort. Malmaison cultum. *D. GRAMINIFOLIUM*, *S. Wats. in Proc. Amer. Acad. xiv. 249* (San Luis Potosi, *Parry & Palmer 876!*), est forma reducta foliis glauco tinctis pedibus vel sesquipedalibus, racemis densissimis 1-2 poll. longis.

5. *D. GLAUCOPHYLLUM*, *Hook. in Bot. Mag. t. 5041.*—*D. glaucum*, *Zucc.; Carrière in Rev. Hort. 1872, 435, cum icone.*—*D. serratifolium Baker in Trimen's Journ. 1872, 228, ex parte.* Truncus in hortis nostris interdum pedalis. Folia 100-200 densissima linearia substricta exteriora recurvata 2-3-pedalia supra basin dilatata 8-9 lin. lata intense glauca acuminata apice integra margine aculeis luteis uncinatis lanceolatis corneis ½-1 lin. longis armata inter dentes serrulata. Inflorescentia 8-10-pedalis. Pedunculus elongatus, foliis reductis multis squarrosis instructus. Panicula angusta 3-4-pedalis, deorsum 3-4 poll. diam., bracteis magnis lanceo-

latis acuminatis scariosis integris, racemis inferioribus 3-5nis, centralibus breviter pedunculatis 2-3 poll. longis, masculis expansis 5-6 lin. diam., bracteis ovatis subintegris 1 lin. longis, pedicellis brevissimis. Perianthium 1 lin. longum, antheris exsertis. Ovarium obovoideum apice emarginatum alis superne latoribus ad stylum haud adnatis. Fructus mihi ignotus. *Mexico*, ad hort. Kew., a Repper introducta. Floruit in Hort. Kew. annis 1857 et 1874, in hort. Glasnevin 1873.

6. *D. SERRATIFOLIUM*, Karw. et Zucc. in *Pl. Nov. Acad. Monac. fasc. iv. 225*, tab. 1. fig. 3 (fructus).—*D. laxiflorum*, Baker in *Trimen's Journ.* 1872, 299. Folia omnino *D. acrotrichi*, bipedalia, supra basin 7-8 lin. lata, aculeis marginalibus corneis luteis $\frac{1}{2}$ -1 $\frac{1}{2}$ lin. longis. Panicula laxa pedalis, bracteis primariis perparvis, ramis ascendentibus laxifloris simplicibus 2-4 poll. longis, inferioribus ternis. Flores subdistantes 3-6ni, bracteis parvis latis membranaceis more *Cordylines* imbricatis, pedicellis bracteis æquilongis (1 lin. longis) apice articulatis. Perianthium masculum 1 lin. longum. Fructus (fide tab. cit.) suborbicularis, alis latis ad stylum adnatis. *Mexico in ditione Oaxacana*, Andrieux 68!

7. *D. BERLANDIERI*, S. Wats. in *Proc. Amer. Acad.* xiv. 249. Habitus et folia ignota. Panicula sesquipedalis, racemis inferioribus 5-7nis congestis sessilibus strictis ascendentibus centrali 2 poll. longo. Bracteæ ovatæ subintegræ 1 $\frac{1}{2}$ lin. longæ. Pedicelli fructiferi 1 $\frac{1}{2}$ lin. longi. Perianthium fructiferum 1 lin. longum. Fructus obovoideus vel suborbicularis 3 $\frac{1}{2}$ -4 lin. longus apice emarginatus, alis latis ad stylum haud adnatis. *Mexico ad Cerro de la Silla Nuevo Leon*, Berlandier 3218! An sit varietas *D. acrotrichi*?

8. *D. PLIABILE*, Baker. Truncus interdum 25-pedalis ramosus. Folia iis *Beaucarniæ recurvatæ* consimilia linearia plana recurvata subtiliter nervata bipedalia infra medium 6-7 lin. lata longe acuminata apice integra margine haud serrulata. Inflorescentia tripedalis. Paniculæ rami inferiores pedales longe pedunculati, basi bracteis magnis lanceolatis acuminatis scariosis præditi, ramulis 8-14 laxifloris 1-2 poll. longis inferioribus patulis, bracteis floriferis minutis deltoideis membranaceis integris, pedicellis solitariis vel geminis apice articulatis, fructiferis 1-1 $\frac{1}{2}$ lin. longis. Fructus late ellipticus 6 lin. longus, 4-4 $\frac{1}{2}$ lin. diam., alis a basi ad apicem æquilatis 1 $\frac{1}{2}$ lin. latis ad stylum haud adnatis. *Mexico, in ditione Yuçatan ad Sisal*, Schott 892! (Herb. Mus. Brit.)

9. *D. HOOKERI*, Lenaire MSS., teste Morren, *Hort. Belg.* xv. 324.—*D. Hartwegianum*, Hook. in *Bot. Mag.* t. 5099, non Zuccar.—*D. cæspitosum*, Scheidw. in *Wochenschrift*, 1861, No. 36?—*Beaucarnea Hookeri*, Baker in *Trimen's Journ.* 1872, 327. Truncus ei *Testudinariæ elephantipedis* consimilis durus globosus areolatus diam. sesquipedali. Rosulæ foliorum ad truncum unum 20-30. Folia (viva) ad cæspitem unum 40-50 anguste linearia recurvata sesquipedalia vel bipedalia deorsum 2-3 lin. lata

pallide glauco-viridia facie canaliculata apice integra margine haud serrulata. Inflorescentia sesquipedalis, pedunculo brevissimo, panícula densa, ramis permultis ascendentibus simplicibus sublaxifloris 2-4 poll. longis, inferioribus foliis reductis basi dilatatis longe acuminatis bracteatis. Bracteæ floriferæ minutæ deltoideæ membranaceæ integræ. Pedicelli brevissimi sæpissime solitarii. Perianthium 1 lin. longum, staminibus exsertis. Fructus indehiscens triquetro-ellipticus 2 lin. longus, angulis nullo modo alatis. *Mexico ad Real del Monte*, a Repper anno 1846 introducta. (V. v. in Hort. Kew.).

10. *D. QUADRANGULATUM*, *S. Wats. in Proc. Amer. Acad.* xiv. 250. Truncus 3-pedalis. Folia saturate viridia bipedalia et ultra inermia recurvata deorsum 2-3 lin. lata sursum angustiora quadrangulata. Pedunculus 5-pedalis. Panícula angusta, pedicellis brevissimis, floribus $1\frac{1}{2}$ lin. longis. Fructus $3\frac{1}{2}$ -5 lin. longus, alis latis ad styli summum adnatis. *Mexico borealis orientalis ad Sierra Nola, Tamaulipas*, Dr. Palmer, anno 1878. (Non vidi.)

Species exclusa.

D. pitcairniæfolium, Zucc., = *Hechtia glomerata*, Zucc.

10. CLARA, Kunth.

Kunth, Enum. v. 295; *Griseb. Symb. Fl. Argent.* 1878, 321.

Flores hermaphroditi. *Perianthium* 6-partitum subcorollinum flavido-viridulum regulare urceolato-campanulatum, segmentis ellipticis basi connatis medio 3-nervatis. *Stamina* 6 profunde perigyna perianthii segmentis duplo breviora, filamentis deorsum dilatatis, antheris versatilibus ovato-oblongis. *Ovarium* liberum sessile ellipticum triloculare, ovulis in loculo paucis superpositis, stylo crasso, stigmatibus tribus brevibus. *Capsula* ovoideo-subglobosa loculicide trivalvis, seminibus in loculo 3-4 compressis alatis, testa atra crustacea, albumine carnosio, embryone axili. Genus mihi haud visum, verisimiliter Anthericoideum.

1. *C. OPHIOPOGONOIDES*, *Kunth et Griseb. loc. cit.* Herba glabra, rhizomate obliquo, foliis radicalibus plurimis graminoidis planis rigidulis 2-3 poll. longis 2-3 lin. latis. Pedunculus sesquipedalis foliis bracteiformibus paucis præditus fere ut in *Antherico ramoso* divisus. Racemi semipedales, bracteis ovato-cuspidatis, pedicellis 2-3nis laxis. Perianthium expansum 3 lin. diam. Capsula semipollicaris. *Brasilia meridionalis*, Sello 3320. *Entre Rios*, Lorentz.

On some new Aroideæ; with Observations on other known forms.
—Part I. By N. E. BROWN, A.L.S., Herbarium Royal
Gardens, Kew.

[Read April 15, 1880.]

(PLATES IV.—VI.)

UNDER the above title I propose to make known to science some of the numerous undescribed Aroideæ contained in the Kew Herbarium, to redescribe or add notes upon imperfectly described or little known species, to give references to figures or descriptions of species which have been omitted by Prof. Engler in his recent account of the Order in DeCandolle's 'Monographiæ Phanerogamarum,' vol. ii., and, lastly, to call attention to those species which have been described or figured since the publication of that work. This, it is hoped, will form a useful supplement to Engler's monograph, and bring our knowledge of Aroids down to the present date.

As regards the limitation of the genera, I have, in most cases, followed Engler; but in their arrangement I prefer to follow Schott, as upon the whole his classification appears to me much the best and simplest that has yet been proposed. The type specimens of all the new species and all the numbers quoted under other species mentioned or described in this part, are preserved in the Kew Herbarium, with the exception of those recently described by other authors, and of Lamont's specimen of *Arisæma penicillatum* from Hong Kong, which is in the British-Museum Herbarium.

Subtribe CRYPTOCORYNINÆ.

CRYPTOCORYNE, *Fischer.*

C. CAUDATA, *N. E. Br.* (Plate IV.)

Lamina folii late elliptica vel ovata, acutiuscula vel obtusiuscula, basi cordata, margine eroso-dentata, intra venas valde depresso-bullata. Spatha petiolo longior, tubo cylindrico, limbo in cuspidem subuliformem quam tubus duplo longiorem prolongato. Spadix $\frac{1}{2}$ poll. longus, syncarpidio* sessili, 6-7 loculari. Borneo, ad flumen Lawas (*Burbridge*!).

* The term syncarpidium was given by Schott to the entire female inflorescence in this genus, which differs from that of all other Aroids. The one-celled ovaries are in a single whorl around and adnate to the base of the slender spadix, and are more or less connate, so as to appear like a several-celled syncarpic ovary, with the slender axis of the spadix rising from its centre. Immediately above the syncarpidium and partly concealed by its styles and stigmas is a second whorl of minute utterly abortive ovaries.

A glabrous aquatic. Petioles 2-6 in. long, vaginate at the base, 1-1½ line thick. Lamina elliptic, broadly elliptic, or ovate, subacute or obtuse, base cordate, with rounded lobes and a short narrow sinus; margin erose-dentate (the teeth are formed by the margin being revolute for short semilunar spaces); primary lateral veins four on each side of the midrib, the two lowest pairs arising at the base and excurrent at the margin, the third pair arising a little above the base, and together with the fourth pair, which arises from ¼-1 in. above the base of the midrib, uniting again with the midrib near the apex, all strongly curved; secondary veins transverse between the primary, between them the leaf is strongly depressed-bullate, dark green above, paler beneath. Spathe subsessile, longer than the petioles; tube cylindric, 2-2½ in. long, pallid; limb blackish purple, in the unopened spathe slightly inflated, and prolonged into a subulate erect tail 4-4½ in. long. Spadix ½ lin. long; syncarpidium sessile, 6-7-celled; styles linear-subulate, stigmatic down the underside, somewhat spreading. Fruit ovoid, ½ in. long, the cells with four seeds in each; seeds elongate, falcate, pale brown. Plumule of embryo of four or five subulate leaves, arising from the dorsal side a little below the middle.

Discovered by Mr. Burbidge in pools, in shady jungles near the Lawas River, North-west Borneo. Mr. Burbidge informs me he found some plants entirely floating, others growing in shallow water with only their leaves floating; it flowers during the dry season, when the water is very shallow. In the specimens seen by me all the spathes were closed, as represented in my drawing, but probably the base of the limb opens a little.

This species seems to be closely allied to *C. longicauda*, Becc., which I have not seen; but, according to Prof. Engler's description of it, my plant differs in its strongly depressed-bullate leaves with erose-dentate margins and an extra pair of primary lateral veins. It is also allied to *C. bullosa*, Becc., from which it differs in its much longer pointed spathe, and to *C. Griffithii*, Sch., from which it is easily distinguished by its much longer pointed spathe and bullate leaves.

CRYPTOCORYNE CORDATA, *Griff.*

The following is an extract from a MS. description of *C. cordata*, made by Mr. J. Mottley in Borneo, and now preserved in the Kew Herbarium, which adds to our knowledge of the plant:—

“A very common and very variable plant, differing in luxuriance, size, and even other more important points, as the rivulets in which it grows are muddy or sandy, shallow or deep, swift or slow. In swift deep water all the parts of the plant are much more developed, the leaves and petioles are longer, and the pedicels [peduncles] some inches long, bearing up the inflated part of the tube of the spathe above the ground; in this form the pointed sterile apex of the spadix is mostly wanting, and the spadix itself is firmly attached by apex to the spathe. In very shallow and still water, on the contrary, the leaves are broader, and the lower part of the spathe covered by the imperfectly sheathing bases of the leaves is, as it were, sessile on the root below the surface of the mud. In every case the long tube is adapted to the depth of the water and keeps up a supply of light and air to the submerged parts of fructification; in very dry weather it rises out of the mud, and is then only 1–2 inches long. The fly-catching disposition of the valve I have found always the same after the pollen is shed, and the inflated tube generally contains half a dozen living insects, attracted probably by the slight carrion smell of the limb of the spathe; the valve rises with force enough sometimes to tear away the attachment of the summit of the spadix. The native name is ‘Tropong ayr,’ or ‘water-trumpet.’ The fruit I have never been able to find; perhaps, as in many extensively creeping plants, it is rarely produced, for I have sought it very industriously.”

CRYPTOCORYNE GRIFFITHII, *Schott, Synop.* p. 1; *Prod.* p. 14.

This plant Engler in his monograph (*DC. Monog. Phanerog.* ii. p. 631) has placed next *C. Gomezii*, Sch., in a subsection characterized as having an oblong-ovoid tube to the spathe; but the tube of the spathe is most distinctly cylindrical, and considerably longer than the limb. Its real affinity is with *C. cordata*, Griff., to which it is closely allied. The Kew Herbarium contains the following specimens:—Malacca (*Griffith*), no. 6012 ex parte! & 6028 ex parte!

C. DALZELLII, *Schott in Bonplandia*, 1857, p. 221; *Prod.* p. 15; *Engler in DC. Monog. Phanerog.* ii. p. 631.

As very little is known of this species, I here add a MS. note of Mr. Dalzell's preserved in the Kew Herbarium:—“It has one sessile leaf at base. Leaf lanceolate, without petiole, and appa-

rently amplexicaul; margin transparent and finely crenated; veins parallel; surface woolly, as if covered closely with cobweb."

CRYPTOCORYNE CILIATA, *Fisch.* To the synonymy of this species add *C. drymorrhiza*, Zipp. in *Miq. Ann. Mus. Bat. i.* p. 122.

The following species of *Cryptocoryne* have recently been described by Prof. Engler:—

C. STRIOLATA, *Engl. in Bull. Soc. Tosc. di Ort.* iv. p. 301; *Reprint (Ar. Born. & Pap.)*, p. 15.

Borneo, Sarawak (*Beccari*, no. 1240).

C. PALLIDINERVIA, *Engl. in Bull. Soc. Tosc. di Ort.* iv. p. 301; *Reprint (Ar. Born. & Pap.)*, p. 15.

Borneo, Sarawak (*Beccari*, no. 3857).

C. LINGUA, *Becc. in Bull. Soc. Tosc. di Ort.* iv. p. 301; *Reprint (Ar. Born. & Pap.)*, p. 15.

Borneo, Sarawak (*Beccari*, no. 3998).

C. SPATHULATA, *Engl. in Bull. Soc. Tosc. di Ort.* iv. p. 301; *Reprint (Ar. Born. & Pap.)*, p. 15.

Borneo, Sarawak (*Beccari*, no. 3917).

C. LONGICAUDA, *Becc. in Bull. Soc. Tosc. di Ort.* iv. p. 302; *Reprint (Ar. Born. & Pap.)*, p. 16.

Borneo, Sarawak (*Beccari*).

C. BULLOSA, *Becc. in Bull. Soc. Tosc. di Ort.* iv. p. 302; *Reprint (Ar. Born. & Pap.)*, p. 16.

Borneo, Sarawak (*Beccari*, no. 3487).

C. AURICULATA, *Engl. in Bull. Soc. Tosc. di Ort.* iv. p. 302; *Reprint (Ar. Born. & Pap.)*, p. 16.

Borneo, Sarawak (*Beccari*, no. 3845).

C. FERRUGINEA, *Engl. in Bull. Soc. Tosc. di Ort.* iv. p. 302; *Reprint (Ar. Born. & Pap.)*, p. 16.

Borneo, Sarawak (*Beccari*, no. 3983).

Subtribe *AMBROSININÆ*.

AMBROSINIA, *Bassi*.

ADDITIONAL ICONES.

A. BASSII, *L., Bot. Mag.* t. 6860.

Subtribe ARISARÆÆ.

PINELLIA, Tenore.

To *P. TRIPARTITA*, Schott, should be added as a synonym *Arisæma tripartitum*; Engler, in DC. Monog. Phanerog. ii. p. 538; and the figure in 'So-Mokou-Zoussets,' 2nd ed. xix. t. 3.

Japan (*Oldham*, nos. 819! 821!), ins. Loo-choo (*Wright*, 319!).

ADDITIONAL ICONES.

P. TUBERIFERA, Ten. Acad. Neap. iv. t. 10; Schott, Gen. Aroid. t. 4. f. 1-20, 30.—*Arum ternatum*, Thbg. Bot. Zeit. 1879, p. 689, xylogr.; *Abh. Leipz.* vii. t. 7 (ex *Pritzel*); *So-Mokou-Zoussets*, 2nd ed. xix. t. 1, and var. *ANGUSTATA*, Engl. at t. 2.

ARISARUM, Targ.-Tozz.

ADDITIONAL ICONES.

A. VULGARE, Targ.-Tozz., *Exp. Scient. de l'Algér.* t. 44. f. 10-12 (seed); Schott, Gen. Aroid. t. 5.

N.B. The plant figured under the erroneous name of *Arum corsicum* in the 'Gardeners' Chronicle,' 1871, p. 1357, f. 301, and Belg. Hort. xxii. 1872, p. 75, f. 1, is an *Arisarum*, and is probably identical with *A. vulgare*.

A. PROBOSCIDEUM, Savi, *Nuovo Giorn. Bot. It.* xi. t. 1.

ARISÆMA, Martius.

Sect. i. Folia trisecta.

A. GALEATUM, N. E. Br. in *Gardeners' Chronicle*, 1879, n. s. xii. p. 102.

Folium solitarium, folio *A. speciosi* simillimum. Petiolum pedunculo quadruplo longius. Spatha extus viridi et albo striata, tubo intus purpureo et albo striata, limbo galeato-fornicato, cum lobo apicali elliptico-oblongo mucronato pendulo instructo. Spadix unisexualis (masculum tantum vidi), synandria 3-5-antherifera, antheris rima circumcissa dehiscentibus; appendice alba, basi incrassata truncata superne sub galea procurva in filum prælongum dependentem attenuata.—*Bot. Mag.* t. 6457. India, Sikkim (*Gammie!*).

Leaf solitary; petiole 1-2 ft. long, terete, tapering upwards, striate, entirely pale green; leaflets 3, all on footstalks about an inch long, rich bright green, with narrow purple crimped margins, the course of the midribs whitish, somewhat rugose above from the impressed midrib and veins, which are all prominent

beneath; lateral leaflets 7-11 in. long, 4-5 in. broad, very oblique, the part on inner side of midrib semilanceolate or semi-oblong-lanceolate, acute at base, the part on outer side semicordate and twice as broad as the inner part; middle leaflet rather shorter than the lateral ones, $3\frac{3}{4}$ - $5\frac{3}{4}$ in. broad, elliptic; all abruptly cuspidate at apex. Peduncle 3-6 in. long, terete, striate, pale green, without markings. Spathe-tube 2-2½ in. long, outside green with white lines, tinted with purplish at base, inside purple with white lines, not plaited; limb galeate, arched over the tube, with a pendent, elliptic-oblong, longitudinally folded, mucronate, terminal lobe, which hangs to about halfway down the tube; galea light green with white lines, the pendent lobe entirely light green. Spadix unisexual, much longer than the spathe; stamiferous part of the male spadix pale purple, 6-8 lines long; synandria scattered (in very lax spirals), stipitate, with 3-5 anthers, with a circumciss dehiscence; pollen white. Appendix white, smooth, shortly stipitate, gradually attenuate from the thick truncate base into a long pendulous thread-like apex. Female unknown.

A very distinct species, resembling *A. speciosum* in its leaf and spadix; but the spathe is entirely different, more resembling that of *A. ringens* and *A. præcox* than any other described species.

ARISEMA ALBUM, *N. E. Br.*

Segmenta folii solitarii petiolulata, subæquilonga. Pedunculus petiolo longior. Spatha alba, limbo ovato-lanceolato subulato-acuminato, tubo subæquilongo. Spadix spatha brevior, androgynus, inflorescentia ex ovariis et synandriis irregulariter mixtis usque medium tubi attingente; appendice tenui, apice decurva, tota organis neutris subulatis obsessa. India, Khasia ad Mausmai 4000 ped. (*Clarke*, no. 7257!).

Leaf solitary, the three leaflets all petiolulate, lateral ones obliquely oblong-elliptic, 8 in. long, $4\frac{1}{2}$ in. broad, somewhat cuspidate-acuminate, ending in a short thread-like point, base of outer moiety broadly rounded-obtuse, of inner moiety cuneate-acute, petiolules 7 lines long; middle leaflet $8\frac{1}{2}$ in. long, $4\frac{1}{2}$ in. broad, rhomboid elliptic, apex acuminate, ending in a short thread-like point, base broadly cuneate acute, petiolule 1 in. long; primary lateral veins 13-15 on each side of the midrib, nearly straight, ascending, making with the midrib an angle of about 40°, united in a collective vein 2-3 lines from the margin. Peduncle longer than the petiole. Spathe white; tube $1\frac{3}{4}$ -2 in. long, smooth

within, margins of the mouth not revolute; limb about as long as the tube, ovate-lanceolate, acuminate into a filiform apex. Spadix bisexual, much shorter than the spathe, but exerted from the tube, apex recurved, the flower-bearing part reaching to about halfway up the tube of the spathe; appendix slender, not thickened at base, the whole of it covered with scattered subulate neuter organs. Synandria stipitate, 2-4-6-anthered; anthers purple. Ovaries globose, with a short style, green.

A very marked plant, quite distinct from all other described Indian species, and of those at present known comes nearest to the following species (*A. penicillatum*) and to *A. ornatum*, Miq., from both of which it is abundantly distinct; it is also allied to *A. cuspidatum*, Roxb., but is quite distinct. It was only once collected by Mr. C. B. Clarke in the Khasia hills at the village of Mausmai; on his label is written, "Plant white: spathe white." Mr. Clarke does not now recollect what the first two words imply, but that probably the leaves are of a very pale whitish green, or perhaps the petiole is white. The position of the ovaries and synandria seems variable, as in one spadix the basal half of the inflorescence is entirely male, the upper half being entirely female; in the other spadix the basal half of the inflorescence is composed of ovaries and synandria mixed, the upper half being entirely male.

ARISEMA PENICILLATUM, N. E. Br. (Plate V.)

Folia duo. Lamina trisecta, segmentis æquilongis, lanceolatis vel ovato-lanceolatis, apice acuminatis, aristatis; lateralibus subsessilibus, basi inæquilatis, intermedio breviter petiolulato. Pedunculus petiolo brevior vel longior. Spathæ tubus limbo longior; limbus incurvatus, breviter oblongus, subrepentino cuspidatus, aristatus. Spadix unisexualis tenuis spatha paulo brevior; appendice apicem versus procurva et processibus subulatis instructa; femineus supra ovaria organis neutris subulatis adscendentibus obsitus.—*A. laminatum*, Benth. in Flora Hongkongensis, p. 342, nec Blume. Hongkong (*Urquhart*, no. 182!; *Harland*, no. 1026!, = *Hance*, 1238, ex *Harland in Herb. Kew.*; "Ravine, Mount Victoria, May 1874," *Lamont in Herb. Mus. Brit.*! *Ford*, no. 1!).

Leaves two. Lamina trisect; leaflets subequal in length, 4-6 in. long, $1\frac{1}{4}$ -2 in. broad, lanceolate or ovate-lanceolate, acuminate and terminated by an arista-like point $\frac{1}{4}$ in. long; middle leaflet shortly petiolulate, cuneate at base; lateral leaflets subsessile, rounded, and the outer side much the broadest at the base, margins entire or very slightly crenulated. Peduncle shorter or

longer than the petiole. Spathe-tube $1\frac{1}{2}$ – $2\frac{3}{8}$ in. long, smooth inside, margins of the mouth not revolute. Limb shorter than the tube, and curved over its mouth, shortly oblong, rather abruptly cuspidate, ending in a short arista-like point. Spadix unisexual, slender, a little shorter than the spathe, exerted, apex more or less curved forwards and covered (in both sexes) with short, stiff, subulate processes (neuter organs?); on the female spadix above the ovaries are also some similar ascending processes or neuter organs, which are absent in the male.

This species has been confounded by Mr. Bentham, in the 'Flora Hongkongensis,' p. 342, with the Javanese *A. laminatum*, Blume; and although it has some slight resemblance to that plant, it is easily distinguished by its very different spathe and spadix. According to a note upon one of Col. Urquhart's specimens (female), the spathe has a green tube and a white limb, and the spadix ends in "short stiff dark-brown hairs."

ARISÆMA LAMINATUM, Blume, var. *INCLUSUM*, N. E. Br.

Spathæ lamina basi absque fascia atro-purpurea transversa. Spadix cum spathæ tubo æquilongus, non exertus. Java (Lobb!).

It is probable that this may prove to be a distinct species, and if so may bear the name of *A. inclusum*; but the material at Kew is not sufficient to decide upon, as there is but one specimen, collected by Lobb in Java, consisting of two inflorescences, one of each sex, and two leaves; unfortunately the larger of the two leaves is detached, and may not belong to the inflorescence. This leaf is much larger, the leaflets different in form, and the veins very much less spreading than in *A. laminatum*; but the leaf attached to the male inflorescence does not seem to differ from that of *A. laminatum*. The spathe is like that of *A. laminatum*, but longer, measuring in the male specimen $4\frac{1}{2}$ in., and in the female 6 in. in extreme length. The limb appears to be concolorous and pale, there being not the slightest trace of a dark fascia at its base, such as *A. laminatum* has, and which is very distinct in all the dried specimens I have seen, although suffused upwards. Lastly, the spadix in both sexes only just reaches to the top of the tube of the spathe, whilst in *A. laminatum* it projects $\frac{1}{2}$ in. beyond and curves forward.

ADDITIONAL ICONES.

A. SPECIOSUM, Mart.—*Arum speciosum*, Wall. Tent. Nepal, p. 29, t. 20.

A. GRIFFITHII Schott, *Bot. Mag.* t. 6491.—*A. Hookeri*, Schott, *Gen. Aroid.* t. 6. figs. 11–19.

A. UTILE, Hook. f. *Bot. Mag.* t. 6474.

A. RINGENS, Schott, *Fl. des Serres*, t. 1269–1270; *So-Mokou-Zoussets*, 2nd ed. xix. t. 16; *Rev. Hort.* 1859, p. 154, f. 34 & 35.—*A. PRÆCOX*, *De Vreise, Regel Gartenfl.* x. p. 1, t. 313; *Rev. Hort.* 1868, p. 331, f. 37; and coloured plate.

A. ATRO RUBENS, Blume.—*Arum triphyllum*, Bigelow, *Med. Bot.* p. 52, t. 4; Schott, *Gen. Aroid.* t. 6. f. 27 (germination).

Sect. ii. Folia pedatisecta.

ARISEMA HETEROPHYLLUM, Blume, *Rumphia*, i. p. 110.

“*A. foliis pedatisectis, segmentis (7–11) omnibus sessilibus oblongis breviscupidatis integerrimis simpliciter penninervigeris, intermedio bilaterilibus minore.*” “*Habitat in Japonia. Ab A. japonico, cui proximum est, satis differre videtur segmento intermedio sessili, vicinis dimidio minori. Hoc scilicet fere 1½ poll. longum, ¼ poll. latum est, cum vicina satis distantia duplo sunt longiora ac latiora, quæ vero ad extremitatem rachidis petiolaris sita sunt magis decrescunt.*”—Bl.

This species Engler, in DC. Monog. Phanerog. ii. p. 546, considers to be a variety of *A. Thunbergii*, Bl., but gives no indication as to whether he had seen the type specimen or not; but if I am right in my identification of this plant, it is, in my opinion, much more nearly allied to *A. tortuosum*, Schott, and *A. curvatum*, Kth. Blume does not describe the inflorescence, neither do Schott or Engler, so that it is probably unknown.

The plant that I identify as *A. heterophyllum*, Bl., is a specimen collected by Oldham (no. 817!) in Surly Island, Korean archipelago, where, he says (in a note attached to the specimen), it is “rather common on the island, amongst grass.” The pedatisect leaf has 15–17 sessile, oblong-lanceolate, shortly cuspidate segments, the middle one being about as long as the first pair of lateral ones. Peduncle longer than petiole. Spathe-tube 2 in. long, margins of the mouth not revolute; limb 3 in. long, ovate-lanceolate, shortly acuminate, apparently curved over the mouth of the tube. Spadix unisexual, the flowering part reaching $\frac{3}{4}$ – $\frac{1}{2}$ the length of the tube; appendix caudiform, 6–7 in. long, at first rather abruptly curved downwards, then recurving upwards, just as in *A. tortuosum*. Synandria stipitate, 2–4-anthered. Female spadix not seen. It will be observed that the leaflets of this specimen are more numerous

than described by Blume; but in another specimen collected by Dr. Shearer in the province of Kew Kiang, China, which I am unable to separate specifically from the Surly Island plant, the leaflets are only 11 in number. As before stated, I would place *A. heterophyllum* (*i. e.* if I am correct in my identification of it), near *A. tortuosum*, Schott, and *A. curvatum*, Kunth. From both of these, and from all others of the group at present known, it is readily distinguished by the middle leaflet being shorter than the lateral ones next it, and by all the leaflets being shortly cuspidate at apex, not acuminate.

ARISEMA DECIPIENS, Schott. In Engler's recent monograph (DC. Monog. Phanerog. ii. 542) this species is placed in a section characterized as having a long subulate pendulous appendix to the spadix; but the spadix of *A. decipiens* (the type specimen of which is in the Kew Herbarium!) is straight and subtruncate at apex, and only slightly exceeds the mouth of the spathe-tube. Its affinity seems to be with *A. japonicum*, Bl., *A. amurense*, Maxim., and *A. quinatum*, Schott. Engler, at the place quoted, says, probably indigenous in Java; but it is a native of the Khasia hills. Schott, in his original description in Oestr. bot. Wochenbl. 1857, p. 373, gives the locality as "Khasia?"; the "?" should have been omitted. The following specimens are in the Kew Herbarium:—Khasia, 5000–7000 feet, Hook. f. & Thoms., at Nurtiung and Pomrang!; Griffith, no. 5973!; Clarke, no. 18363!, at Jaintea.

The descriptions of the following two species are omitted by Engler in his monograph (DC. Monog. Phanerog. ii. p. 560); they will be found fully described at the places cited below:—

A. SIKOKIANUM, Franch. & Savat. En. Plant. Japon. ii. p. 507 (and p. 6, name only).

Seems to be allied to *A. quinatum*, Schott, and perhaps is the same as the plant figured in the second edition of the 'So-Mokou-Zoussets,' vol. xix. t. 17. It is intermediate between the sections *Trisecta* and *Pedatisecta*.

A. ANGUSTATUM, Franch. & Savat. En. Plant. Japon. ii. p. 507 (and p. 6, name only).

Allied to *A. serratum*, Schott.

The names only of the above two species appeared in part i., and the descriptions in part. ii. of vol. ii.; both parts were published in 1876.

ADDITIONAL ICONES.

- A. FILIFORME, *Blume, Schott, Gen. Ar. t. 6. figs. 1-10, 28.*
 A. DRACONTIUM, *Schott, Torrey, Fl. New York, ii. p. 240, t. 123.*
 —ARUM DRACONTIUM, *L., Schkuhr, Handb. iii. p. 216, t. 277.*
 A. JAPONICUM, *Bl., So-Mokou-Zoussets, 2nd. ed. xix. t. 12.*
 A. SERRATUM, *Schott, So-Mokou-Zoussets, 2nd ed. xix. t. 13.*
 A. THUNBERGII, *Schott, So-Mokou-Zoussets, 2nd ed. xix. t. 14-15.*

Sect. iii. Folia radiatisecta.

ARISEMA PULCHRUM, *N. E. Br. (Plate VI.)*

Segmenta folii solitarii circiter 10, radiata, obverse lanceolata, apice repentino cuspidata, longe cuneata, margine integerrimo revoluto. Spathæ tubus 3 poll. longus, albo et viridi vel purpurascente vittatus, parte superiore hiante, faucis marginibus valde revolutis; limbus 5 poll. longus, viridis albo vittatus, e basi late ovata in caudam longam procurvam pendulam sensim acuminatus. Spadix androgynus (in specim. unico), spathæ tubum paulo superans, supra parte feminea cylindrica (in specim. viso), organis neutris subulatis patentibus et synandriis obsitus; appendice viridi, cylindrica, obtusa, basi paulo incrassata. Ex India allatum in hort. W. Bull cultum.

Leaf solitary, petiole stout, terete, smooth, pale green, suffused with pale reddish brown, and marked with spots of a lighter faintly pinkish colour, shaded with darker. Leaflets about 10, subsessile, radiate, dark green above, pale, somewhat glaucous green beneath, obovate-lanceolate, apex abruptly cuspidate, cuneate from about $\frac{1}{3}$ below apex in a nearly straight line to the very acute base, margins revolute, entire; leaflets decreasing in size from the posterior one, which is 6 in. long and $2\frac{1}{2}$ in. broad, to the anterior ones, which are about $4\frac{1}{2}$ in. long and $1\frac{1}{2}$ in. broad. Primary lateral veins numerous, nearly straight, ascending, and as well as the midrib impressed above, prominent beneath; pseudo-nerve $1\frac{1}{2}$ -2 lines distant from the margin. Peduncle stout, terete, smooth, pale green, suffused with reddish brown, darker upwards. Spathe-tube 3 in. long, smooth inside, light green, tinged with purplish at base, with numerous parallel white stripes, basal half convolute, upper half gaping, margins of the mouth of the tube strongly revolute; limb 5 in. long, basal half light, somewhat yellowish green with white stripes (continued up from the tube), broadly ovate-acuminate, overarching the tube and prolonged into a long pendent caudiform apex, green, tinged with brownish.

Spadix a little longer than the tube, and androgynous (always?), female part cylindric, about $8\frac{1}{2}$ lines long; ovaries crowded, green, globose, with a short style, about 5-ovuled; the part between the ovaries and base of appendix sparsely covered with scattered, subulate, spreading, neuter organs and a few synandria; synandria with 3-5 purple anthers; appendix 2 in. long, bright green, stout, cylindric, obtuse, slightly thickened at base.

The only specimen I have seen of this is a plant cultivated by Mr. W. Bull, introduced from some part of India. The spadix of this is androgynous; but I suspect that properly it should have been female, and that the synandria are abnormally developed, especially as on the dorsal side of the spadix at its base, mixed with the ovaries, are also a few (about 8) synandria, as shown in Pl. VI. fig. 3 at *a*. On the left side of the spadix, at *b*, is shown, among the neuter organs, three which show a transition from the ovaries to the subulate neuter organs: two of these are magnified in figs. 8 and 9, the three bodies protruding from the middle of fig. 8 represent ovules, probably abortive; the organ represented by fig. 9 has merely a triangular cavity at apex.

This species comes near to *A. Cumingii*, Sch., but may easily be distinguished by the following characters:—leaflets distinctly cuspidate, and without the long arista-like point terminating those of *A. Cumingii*; the subulate apical part of the limb of the spathe is not half as long and not so slender as in *A. Cumingii*, and the female part of the spadix only half as long.

ARISÆMA FILICAUDATUM, N. E. Br.

Folii solitarii segmenta 6, radiata, breviter petiolulata, late lanceolata vel oblongo-lanceolata, apice acuminata, basi cuneata. Pedunculus petiolo subæquilongus. Spathæ tubus $1\frac{1}{2}$ poll. longus, limbus basi vix 1 poll. longus, latissime ovatus, in filum 6 poll. longum apice clavato repentino excurrens. Spadix (masculus tantum notus) tenuis, unisexualis, $1\frac{1}{2}$ poll. longus, masculi inflorescentia $\frac{1}{2}$ poll. longa; appendice basi non incrassata, supra medium leviter attenuata, apice clavata levi. Ceylon, Morowekorle 3000 ped., July 1868 (*Thwaites*, no. 3980!).

Leaf solitary, petiole 1 foot long; leaflets 6, radiate, shortly petiolulate, the larger 7 in. long, $2\frac{1}{2}$ in. broad, the smallest 5 in. long, $1\frac{1}{2}$ in. broad, broadly lanceolate or oblong-lanceolate, acuminate, ending in a fine point, base cuneate, acute; texture of the dried leaves extremely thin and delicate. Peduncle as long as petiole. Tube of spathe about $1\frac{1}{2}$ in. long, smooth inside; basal

part of limb hardly 1 in. long and about $1\frac{1}{2}$ in. broad, very broadly elliptic ovate, abruptly contracted into a filiform tail 6 in. long, slightly clavate at apex. Spadix unisexual; male $1\frac{1}{2}$ in. long, straight, very slender, less than 1 line thick in the dried state, with the basal third rather closely covered with subsessile 4-anthered synandria; appendix not thickened at base, or but very slightly so, slightly attenuate above the middle, with a clavate smooth apex; female not seen.

Of this I have seen but one specimen, in the Kew Herbarium, sent by Dr. Thwaites in 1868. Its nearest affinity appears to be with *A. echinatum*, Schott; but it is very distinct from that species, being easily recognized by its smaller longer-tailed spathe, and more slender non-echinate spadix.

ARISÆMA CONCINNUM, Schott in *Bonpl.* 1859, p. 27; Schott, *Prod.* p. 50; *Bot. Mag.* t. 5914; *Gardeners' Chronicle*, 1880, n. s. xiii. p. 434.

In all the places here quoted, this species is described as having the spathe of the male plant purple with white stripes, and of the female green with white stripes; but in reality both sexes occur with both colours. I have seen male and female spathes purple and white, and also green and white, upon plants cultivated at Kew; and the very plants mentioned by the writer in the 'Gardeners' Chronicle' were males with green and white spathes. I scarcely think the colour in this case of specific value.

ADDITIONAL ICONES.

A. NEPENTHOIDES, *Mart.*, *Bot. Mag.* t. 6446; Schott, *Gen. Aroid.* t. 6. figs. 20-26.

A. MURRAYI, *Grah.*, *Fl. des Serres*, t. 1322.

Subtribe ARINEÆ.

BIARUM, Schott.

Sect. *Ischarum*, Blume.

The following species are omitted from Engler's monograph:—

B. FRAASIANUM, *N. E. Br.*—*Ischarum Fraasianum*, Schott in *Oest. bot. Zeitschr.* 1859, p. 98; *Prod.* p. 68.

“Vaginæ bracteantes 5-6, latæ. Folia . . . Spathæ tubus parum ventricosus, subcylindroideus ad medium circiter connatus; lamina ovato-lanceolata vel oblonga, breviter cuspidata, expansa. Spadix mediam

spatham paulo superans, dimidia sua longitudine sexualis. Ovaria longe stylata. Organa neutra rara, sparsa, longa, ovariis vicina. Appendix sensim incrassata, apicemque versus reattenuata.—In campis Thebaicis (*Fraas*)."

BIARUM ANGUSTATUM, *N. E. Br.*—*Ischarum angustatum*, *Hook. f. in Bot. Mag. t. 6355.*

"Foliis longe crasse petiolatis oblongo-lanceolatis subacutis, spathæ tubo oblongo modice inflato in laminam anguste lineari-oblongam vel loriformem acuminatam saturate purpuream vix angustato, spadiceis parte feminea brevi, organis neutris subulatis sparsis, antherarum spica pollicari, appendice gracillimo atro-purpureo spatha brevior, ovariis confertis, stylo brevi adscendente apice recurvo." Syria.

B. SEWERZOWI, *Regel, Descript. Plant. fasc. vii. p. 203 (1879).*

"Folia omnia radicalia, e basi vaginata in petiolum excurrentia; foliorum lamina hastato-triloba, lobis basilaribus horizontaliter patentibus lanceolatis acutis, lobo intermedio magis elongato ovato-lanceolato acuto. Scapus folia circiter æquans. Spatha basi in tubum brevem connata, in laminam oblongo-lanceolatam sensim attenuatam producta. Spadix basi foemineus, supra infraque spicam masculam organis neutris filiformibus vestitus, in appendicem elongatam teretem nudam excurrens. Baccæ depresso-globosæ, stigmatibus sessilibus hemisphæricis umbilicatæ. *Hab.* In montibus Karatavicis (*Sewerzow*, cfr. pl. *Semenov. no. 1006* in adnotatione), in valle fluvii Sarawschan prope Chos-chaduk, in angustiis Makschewat et inter Warsaminor et Peti, in Kokania in angustiis Chodscha Tschiburgan et prope Schagimardan (*O. Fedtschenko*)."

ADDITIONAL ICONES.

B. TENUIFOLIUM, *Schott, Rehb. Fl. Germ. vii. p. 4, t. 6; Gard. Chron. 1871, p. 647, f. 133.*

B. HAENSLERI, *Willk. Bot. Zeit. 1847, p. 49, t. 2.*

SAUROMATUM, *Schott.*

The three following species are omitted by Engler in his monograph:—

S. PULOHURUM, *Miq. Ann. Mus. Bot. Lug. Bat. i. p. 221.*

"Scapus basi bibracteatus; spathæ lamina lanceolata sursum angustata, extus pallide e flavo viridula, intus margine purpurea, cæterum in superficie flavescente purpureo maculata; spadix spatham circiter adæquans; pars sterilis gracilis teres apice obtusa saturate viridis subsulcata; folia pedato-septempartita." Sumatra, in prov. Palembang.

SAUROMATUM *SESSILIFLORUM*, *Kunth, En. Plant.* iii. p. 28; *Schott, Prod.* p. 71.—*Arum sessiliflorum, Roxb. Fl. Ind.* iii. p. 507; *Wight, Icones*, iii. p. 6, t. 800. India, ad Cawnpore (*Roxburgh*).

This species is readily distinguished from all the others by the coloration of the spathe, which I nowhere find properly described. The following note upon the colour is based upon a copy of Roxburgh's original drawing in the Kew Herbarium:—Tube of the spathe externally of a dirty green suffused with purple; the limb externally is green marked with red at the edges. Internally it has a very broad, obscurely mottled, deep violet-purple band running up the centre; on each side of this band it is light greenish with small red linear markings, the margins narrowly bordered with darker green. The appendix is light chrome-green.

S. PUNCTATUM, *C. Koch in Wochenschrift für Gärtn. und Pflanzenk.* 1858, i. p. 263; *N. E. Br. in Gardeners' Chronicle*, 1880, n. s. xiv. pp. 134, 198.

“Petiolus clatus, maculatus; lamina trifoliata, foliolo medio solitario elliptico, longe acuminato, lateralibus pedato-septempartitis, laciniis exterioribus minoribus; pedunculus brevis; spathe elongatæ pars aperta, basi brunneo maculata excepta, unicolor, sed striata.” *Habitat?*

S. SIMLENSE, *Schott in Oesterr. bot. Zeitsch.* 1858, p. 349; *Prod.* p. 72.

“Folium pedatum sub 9-partitum, partitionibus oblongo-lanceolatis, longe acuminatis, petiolo maculato variegato. Spatha brevis, 4-pollicularis, acuminata. Spadix spatha longior, supra ovaria organis neutris nonnullis contiguis obsitus. Appendix subulata quam reliquus spadix paulo brevior.” *Habit.* in Simla (*T. Thomson*).

This is considered by Engler as synonymous with *S. venosum*, Schott (see Engler in DC. Monog. Phanerog. ii. p. 571); but it is very distinct, being easily distinguished from that and all other described species by its small inflorescence, the spathe being not more than about $\frac{1}{3}$ or $\frac{1}{4}$ as large as that of *S. venosum*; the limb appears to be unspotted, and the appendix of the spadix (in the dried specimen) is very slender and subulate; furthermore, it produces leaves at the time of flowering, which does not appear to be the case with any of the other described species. Its affinity seems to be with *S. punctatum*, C. Koch. The type specimen of *S. simlense* is in the Kew Herbarium, and has not been seen by Prof. Engler.

ADDITIONAL ICONES.

SAUBROMATUM VENOSUM, *Schott.*—*S. guttatum*, *Lem. Jard. Fleur.* i. t. 12.

ARUM, *L.*

A. GRIFFITHII, *Schott, Synop.* p. 15; *Prod.* p. 99.

Petiolus $4\frac{1}{2}$ –18 poll. longus. Lamina folii hastata vel hastato-oblonga, lobo antico oblongo-acuto, 3–6 poll. longo, $1\frac{1}{2}$ – $2\frac{1}{2}$ poll. lato, lobis posticis oblongis vel elongato-oblongis, obtusis, 1–3 poll. longis. Pedunculus petiolo longior vel subæquilongus. Spatha $3\frac{1}{2}$ –4 poll. longa, tubo subcylindrico, limbo anguste lanceolato-acuminatus. Spadix spatha brevior, subsessilis; ovariis globosis; organis neutris filiformibus tortuosis, inferioribus 4–5-cyclis, superioribus 2–3-cyclis; appendice cylindrica obtusa, basi in stipitem angustata.—*Engler in DC. Monog. Phanerog.* ii. p. 596.—*Arum* sp., *Griffith's Itinerary Notes*, p. 350. Afghanistan (Otipore Bharowul, *Griffith*, no. 6001!; Kuram Valley, *Aitchison*, no. 125!).

Tuber subglobose or oblong, producing 2–3 leaves; petioles $4\frac{1}{2}$ –18 in. long, vaginate from $\frac{1}{3}$ to $\frac{1}{2}$ their length; lamina hastate or hastate-sagittate, 3–6 in. long, front lobe oblong acute, basal lobes oblong or narrow oblong, obtuse, half as long as the front lobe. Peduncle as long or longer than the petioles. Spathe $3\frac{1}{2}$ –4 in. long; tube subcylindric before fertilization of the ovaries, afterwards ventricose, green; limb narrow lanceolate acuminate, longer than the tube, outside green suffused with purple, inside purple. Spadix shorter than the spathe, almost sessile, floriferous part included in the spathe-tube; ovaries subglobose, greenish; anthers dark purple; neuter organs filiform from a swollen base, curled, purple, the lower series 4–5-cyclic, upper series 2–3-cyclic; appendix stipitate, $1\frac{1}{2}$ in. long, cylindric, obtuse, narrowed at base into the stipes, dark purple. Ripe berries bright red, 2–4-seeded; seeds globose, slightly scrobiculate, pale brown, $\frac{1}{8}$ in. in diameter. The appendix, anthers, and ruptured spathe persist during the ripening of the fruit.

According to a note of Dr. Aitchison's, this species is "profuse under bushes from the foot of Péwár Kotal to Alikhél." Its affinity is with *A. hygrophilum*, Boiss.

ADDITIONAL ICONES.

A. SYRIACUM, *Bl., Schott, Gen. Aroid.* t. 18. figs. 1, 5–15, 17–39.

A. NIGRUM, *Schott, Gen. Aroid.* t. 18. f. 16.

ARUM ITALICUM, *Mill.*, *Acad. Neap.* 1851, vi. t. 1; *Kern. Hort.* t. 209; *Regel, Gartensfl.* xiii. p. 36, t. 426; *Engl. Bot.* 3rd ed. ix. p. 15, t. 1393; *Ann. Sc. Nat.* 3rd ser. xv. p. 37, t. 2 (abnormal flower).

A. NUMIDICUM, *Schott, Gen. Aroid.* t. 13. f. 2-4.

A. ORIENTALE, *Mar. v. Bieb., Rehb. Fl. Germ.* vii. p. 5, t. 9; *Abh. Leipz.* vii. t. 7 (ex *Pritzel*).

A. MACULATUM, *L., Woodv. Med. Bot.* iv. t. 249; *Baxter, Brit. Bot.* iv. t. 261; *Schrank, Fl. Monac.* ii. t. 123; *Sturm, Flora*, xi. t. 44; *Nees, Plant. Med.* i. t. 20; *Dietr. Fl. Bor.* iv. t. 223; *Dict. Sc. Nat.* t. 3; *Curt. Fl. Lond.* ii. t. 35 (ex *Pritzel*), and large ed., plates not numbered; *Verhandl. Rheinl.* v. t. 1; *Ann. Nat. Hist.* 1853, xii. p. 13, t. 3, f. 8 (ovary); *Abh. Leipz.* vii. t. 7 (ex *Pritzel*); *Engl. Bot.* 3rd ed. ix. p. 13, t. 1392; *Burnett, Pl. Util.* ii. t. 50 a.—A. vulgare, *Lamk. Encycl.* t. 740.

A. CRETICUM, *Boiss., Raulin, l' Ile de Crète*, p. 568, t. 17.

THERIOPHONUM, *Blume.*

T. ZEYLANICUM, *N. E. Br.*

Lamina folii hastata, lobo antico quam postici duplo longiore, omnibus anguste oblongo-linearibus subacutis, vel antico elongato-ovato-deltoido acuminato posticis deltoideo-ovatis subobtusis vel lanceolatis acuminatis. Pedunculus petiolis multo brevior. Spatha $2\frac{3}{4}$ – $3\frac{1}{2}$ poll. longa. Spadix $1\frac{3}{4}$ – $2\frac{1}{4}$ poll. longus; antheris rotundatis, breviter rostratis; organis neutris inferioribus $1\frac{1}{2}$ lin. longis, quam superiores quadruplo longioribus.—Arum (Typhonium) divaricatum, *Thwaites, En. Pl. Zeyl.* p. 334. Ceylon (*Thwaites*, no. 3666!).

Tuber subglobose, $\frac{1}{2}$ in. in diameter, producing 2-3 leaves. Petioles 4-12 in. long, shortly vaginate at base. Lamina trilobate-hastate; lobes all narrow oblong-linear, subacute, about $\frac{1}{2}$ in. broad, or the front lobe elongate-deltoid-ovate-acuminate, and the nearly horizontally spreading basal lobes ovate subobtusate or lanceolate-acuminate, basal sinus broad and shallow; front lobe $3\frac{1}{2}$ –7 in. long, $\frac{1}{2}$ – $2\frac{1}{4}$ in. broad above the basal lobes, which latter measure $3\frac{1}{2}$ – $7\frac{1}{2}$ in. from point to point. Peduncle $1\frac{1}{2}$ –4 in. long. Spathe $2\frac{1}{2}$ – $3\frac{1}{2}$ in. long. Spadix $1\frac{3}{4}$ – $2\frac{1}{4}$ in. long.; ovaries few, ascending; anthers short and roundish, shortly rostrate; lower neuter organs subulate-filiform, $1\frac{1}{2}$ line long, upper neuter organs $\frac{1}{3}$ – $\frac{1}{2}$ line long, subclavate. Appendix slender, cylindric.

This species is allied to *T. Wightii*, Schott, which it resembles in the form of the leaf, but differs in its very much smaller spathe, and especially in its anthers, which are not more than half as long as those of *T. Wightii* and have a roundish outline, whereas in *T. Wightii* they are most distinctly oblong. The first leaf, or the leaves of young plants, seem to be sometimes oblong-acute or acuminate, sagittate at base, with short rounded auricles.

As to *T. Wightii*, Schott, I do not agree with Engler in considering it a variety of *T. crenatum*, Bl.; and he is decidedly wrong in quoting *Arum crenatum*, Wight, as a synonym of *T. Wightii*, as that is the very plant upon which Blume founded *Therophonum crenatum*, and in my opinion is quite distinct from *T. Wightii*; of this latter there is but a single specimen (the type!) in the Kew Herbarium, which Prof. Engler has not seen. The two species may be distinguished by the following characters:—

THERIOPHONUM CRENATUM, Blume, *Rumphia*, i. p. 128.

Leaves roundish oblong, or deltoid-oblong, or deltoid, cordate-sagittate, or sagittate-hastate at base; front lobe nearly as broad as long, or sometimes broader, very obtuse, apiculate; basal lobes short and roundish, or rhomboid-oblong. Anthers with a very short beak, much shorter than the cells, which, taken together, are as broad as long, or rather broader, and somewhat roundish in outline. Lower neuter organs $1\frac{3}{4}$ – $2\frac{1}{4}$ lines long.—*Arum crenatum*, Wight in *Hook. Bot. Misc.* ii. p. 100, t. 3.—*Typhonium crenatum*, Schott, *Melet.* i. p. 17.—*Therophonum crenatum*, Miq. *Fl. Ind. Bat.* iii. p. 196; Schott in *Oest. bot. Zeitschr.* 1858, p. 2; *Prod.* p. 102; Engler in *DC. Monog. Phanerog.* ii. p. 606.—*T. crenatum*, var. *Heynei*, Engler in *DC. Monog. Phanerog.* ii. p. 607. India, Madras, Wight! "Mootaloor, in wet places, hb. Wight," Wallich, no. 8934!

T. WIGHTII, Schott in *Oesterr. bot. Zeitschr.* 1858, p. 3.

Leaves distinctly hastate, the front lobe about twice as long as broad, acutish; basal lobes rhomboid-oblong, obtuse, not deflexed. Anthers twice as large as those of *T. crenatum*, with a long beak, which is as long, or longer, than the cells; the cells, taken together, are longer than broad and distinctly oblong in outline. Lower neuter organs 3– $3\frac{1}{4}$ lines long, twice as stout as those of

T. crenatum.—Schott, *Prod.* p. 103.—*T. crenatum*, var. *rostratum*, Engler in *DC. Monog. Phanerog.* ii. p. 607 (excluding syn. *Arum crenatum*, Wight). Madras (Wight!).

The restitution of the above species renders it necessary to change the name of *T. Wightii*, Engler, for which I substitute the following:—

TYPHONUM INFAUSTUM, *N. E. Br.*—*T. Wightii*, Engler in *DC. Monog.* ii. p. 608, non Schott.—*Calyptrocoryne Wightii*, Schott in *Oesterr. bot. Wochenbl.* 1857, p. 262; *Prod.* p. 105; *Gen. Aroid.* t. 16. India (Paulhauthcherry, August 1844, Wight, no. 2775 Kew distribution!).

TYPHONIUM, Schott.

T. PEDATUM, Schott in *Oesterr. bot. Wochenbl.* 1857, p. 262; *Prod.* p. 108.

Petiolus 7 poll. longus. Lamina pedatisecta, segmentis 7 subdistantibus lanceolatis acuminatis basi angustatis, 4 poll. longis, 8–9 lin. latis, extimis minoribus. Pedunculus $1\frac{3}{4}$ poll. longus. Spatha $2\frac{1}{4}$ poll. longa, acuminata. Spadix spatha brevior; ovariis oblongo-ovoidiis, uniovulatis; organis neutris erectis, ovariis contiguis, numerosissimis, confertis, polycyclis, omnibus filiformibus, interstitii partem inferiorem tantum occupantibus; appendice tenui, quam spadix cetera duplo longiore. Pegu (McLelland!).

Engler appears to have misunderstood this species; the plant he describes as *T. pedatum*, in *DC. Monog. Phanerog.* ii. p. 613, is the *Heterostalis pedata* of Schott, which name Engler gives as a synonym of *Typhonium pedatum*. I have not seen *Heterostalis pedata*, Sch.; but, to judge from the description, it must be very different from *Typhonium pedatum*.

Schott founded his *T. pedatum* upon a flowering specimen collected by Dr. McLelland in Pegu and some fruiting specimens collected by Sir J. D. Hooker in Sikkim; but these latter are different from the Pegu plant; and being incomplete, I deem it best to consider the Pegu plant the sole type of the species: therefore I have given the above description of it.

The Sikkim plant has also been collected by Mr. C. B. Clarke, no. 26708, Darjeeling, 7500 feet, but only in a fruiting state; so that until flowering specimens are obtained it cannot be fully described. For the Javan plant I propose the following name:—

T. (§ HETEROSTALIS) FALLAX, *N. E. Br.*—*T. pedatum*, Engler in

DC. Monog. Phaner. ii. p. 613 (*nec Schott.*).—*Heterostalis pedata*, *Schott in Ann. Mus. Lugd. Bat.* i. p. 278.

TYPHONIUM TRILOBATUM, Schott.

To the synonymy of this species as given by Engler add:—*Engler in Bull. Soc. Tosc. di Ort.* iv. p. 301; *Reprint (Ar. Born. & Pap.)*, p. 15.—*T. siamense*, *Engler in DC. Monog.* ii. p. 615.—*T. triste*, *Griffith, Notulæ*, iii. p. 145.—*Arum orixense*, *Roxb., Lodd. Bot. Cab.* t. 422.

I can find nothing whatever whereby to separate *T. siamense* from *T. trilobatum*; the synonym *T. triste*, Griff., is entirely omitted by Engler. From his monograph it appears that he has seen very few specimens of *T. trilobatum*. The following are contained in the Kew Herbarium:—

Ceylon (*Thwaites* no. 2896! *Walker* no. 123!); Bengal (*Griffith* no. 5999! *Hook. f. & Thomson!* *Jenkins!*); Assam (*Masters*); Mergui (*Griffith* no. 5998!); Malacca (*Griffith* nos. 5996 = *T. triste*, *Griff.*! 5997!); Siam (*Schomburgk* no. 334 = *T. siamense*, *Engl.*!); *Wallich, Cat.* no. 8829 c!; *Dacca (C. B. Clarke* nos. 17082! 6739!).

T. HUEGELIANUM, Schott, vide *N. E. Brown in Gardeners' Chronicle*, 1879, n. s. xii. p. 70, sub *Heterostalis Huegeliana*; and *Schott, Gen. Aroid.* t. 18. f. 4-6.

Engler, in *DC. Monog. Phanerog.* ii. p. 618, places this as a variety of *T. diversifolium*, Wall. It may be so; but there are differences in the inflorescence that ought not to be overlooked.

In *T. Huegelianum*, Schott, the appendix of the spadix is as long and usually very much longer than the rest of the spadix; the neuter interval (between ovaries and anthers) is covered in the upper part with very small pointed deflexed tubercles, which almost become obliterated in drying.

In *T. diversifolium*, Wall., the appendix of the spadix is shorter than the rest of the spadix, and much more slender than that of *T. Huegelianum*; the upper part of the neuter interval covered with short deflexed subulate-pointed tubercles, which are distinctly seen in the dried state, and are longer than those of *T. Huegelianum*. The spathe, too, seems to be smaller than that of *T. Huegelianum*.

The only specimens of *T. diversifolium* I have seen belong to no. 8933 A of Wallich's Catalogue, from Nepal, the type of this species! No. 8933 B, from Kumaon, is *T. Huegelianum*, Schott.

TYPHONIUM CUSPIDATUM, *Dcne.*

To the synonymy of this plant as given by Engler, add:—*Arum angulatum*, *Griff. Notulæ*, iii. p. 143?—*A. flagelliferum*, *Griff. Notulæ*; iii. p. 144.—*A. flagelliforma*, *Griff. Itinerary Notes*, p. 13. no. 193.

ADDITIONAL ICONES.

T. DIVARICATUM, *Dcne. Schott, Gen. Aroid. t. 17; So-Mokou-Zoussets*, 2nd ed. xix. t. 4.—*Arum trilobatum*, *Lodd. Bot. Cab. t. 516; Engler in Bull. Soc. Tosc. di Ort. iv. p. 300; & Reprint (Ar. Born. & Pap.), p. 14.—? Kern. Hort. t. 285 (ex Pritzel).*

HELICOPHYLLUM, *Schott.*

ADDITIONAL ICONES.

H. ANGUSTATUM, *Schott, Aroid. p. 20, t. 29; Schott, Gen. Aroid. t. 20. figs. 2, 9–11, 14, 15.*

H. CRASSIPES, *Schott, Aroid. p. 20, t. 28; Schott, Gen. Aroid. t. 20. figs. 1, 3–8, 13, 16–29.*

H. OLIVIERI, *Schott, Aroid. p. 20. t. 30.*

HELICODICEROS, *Schott.*

ADDITIONAL ICONES.

H. CRINITUS, *Schott, Geel. Sert. Bot. 6. t. 49.*

DRACUNCULUS, *Schott.*

ADDITIONAL ICONES.

D. VULGARIS, *Schott, Icon. Ar. t. 23–24.—Arum Dracunculus, L., Trans. Linn. Soc. xxii. p. 407, t. 68. f. 16–19 (germination).*

D. CANARIENSIS, *Schott, Icon. Ar. t. 25.*

EXPLANATION OF THE PLATES.

PLATE IV.

Cryptocoryne caudata, N. E. Br.

- Fig. 1. Leaf, natural size.
 2. Spathe, natural size.
 3. Base of spathe cut open, magnified 2 diameters.
 4. Spadix, magnified 5 diameters.
 5. Anther, seen from above, magnified 25 diameters.

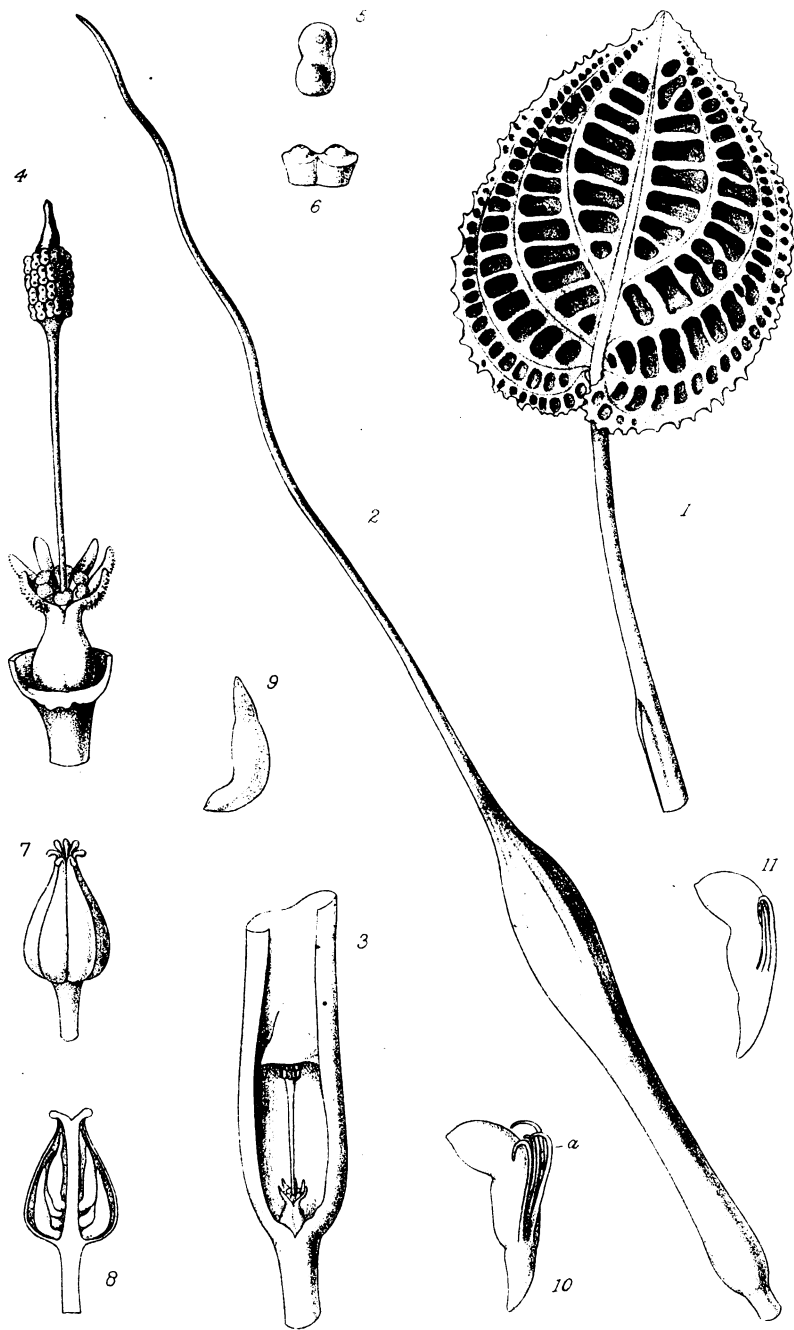

J.N.Fitch lith.

CRYPTOCORYNE CAUDATA, NE.Brown.

Fitch





- Fig. 6. Anther, side view, magnified 25 diameters.
 7. Fruit, natural size.
 8. Fruit, longitudinal section, natural size.
 9. Seed, magnified 2 diameters.
 10. Embryo, showing the leaves of the plumule at *a* slightly displaced, magnified 4 diameters.
 11. Embryo, longitudinal section, magnified 4 diameters.

PLATE V.

Arisæma penicillatum, N. E. Br.

- Fig. 1. Part of plant, natural size.
 2. Female spadix, slightly enlarged.
 3. Male spadix, slightly enlarged.
 4. Ovary, enlarged.
 5. Ovary, longitudinal section, enlarged.
 6. Ovary, transverse section, enlarged.
 7. Two groups of stamens, enlarged.

PLATE VI.

Arisæma pulchrum, N. E. Br.

- Fig. 1. Part of leaf, natural size.
 2. Inflorescence, natural size.
 3. Spadix, natural size.
 4. Ovary, enlarged.
 5. Ovary, longitudinal section, enlarged.
 6. Ovary, transverse section, enlarged.
 7. Ovule, enlarged.
 Figs. 8 and 9. Organs showing a transition from ovaries to neuter organs, enlarged. These are shown in position upon the spadix in fig. 3 at *b*.
-

Notes on a Collection of Flowering Plants made by L. Kitching, Esq., in Madagascar in 1879. By J. G. BAKER, F.R.S.

[Read November 4, 1880.]

(PLATES VII. & VIII.)

IN the present paper I wish to describe 28 new flowering plants, and notice a few of the most interesting of those already known, which are contained in a collection made last year (1879), during an extensive missionary tour in Madagascar, by my friend Langley Kitching of Leeds. The party to which he belonged landed at Tamatave and first made their way to Antananarivo, the capital city of the Hovas, which is situated on a dry bare rocky eminence about 70 miles from the coast in S. lat. 19° , at an elevation of about eight thousand feet above sea-level. The principal districts in which the plants were collected are the northern and eastern slopes of the mountains of Ankaratra, the highest range in the island, situated some thirty miles south-west of the capital, in the province of Imerina, or, as Bojer wrote it, Emirna, attaining an elevation of 9000 feet or more. The Betsileo country occupies the central mountain-range between the 21st and 22nd parallels of latitude, and the Ibara country lies still further south. Tanala occupies the slope of the central mountains towards the eastern coast between lat. 21° and 23° . The part visited was the neighbourhood of the town of A'manga, in the extreme north. I have already, in the Journal of Botany, 1880, p. 326, given a full list of the Ferns of the collection. There are now upwards of 200 species known in the island, of which Mr. Kitching gathered about 120, of which 10 proved to be new. The majority of the 200 are, of course, tropical and subtropical types; but the higher mountains, like those of Bourbon, produce a few characteristically temperate forms, such as *Lycopodium clavatum*, *Nephrodium Filix-mas*, and *Aspidium aculeatum*. The flowering-plants of the island are much less fully known than the Ferns; and we have in the Kew herbarium considerable collections made by Bojer, Lyall, and Meller, which have never been worked out specifically.

RANUNCULUS PINNATUS, Poir. Ankaratra mountains. Widely spread in the Cape and Tropical Africa.

CLEMATIS (§ *FLAMMULA*) *IBARENSIS*, Baker, n. sp.

A climber, with very slender obscurely pubescent branches. Fully-developed leaves pinnate; petiole 1-1½ in. long; leaflets 5, ovate-lanceolate, cuspidate, rounded at the base, dentate, 2-3

in. long, all distinctly stalked, green and obscurely pubescent above, grey and more densely pubescent beneath. Flowers forming a lax panicle a foot long at the end of the branches, its lower forks about as long as the fully-developed leaves which subtend them, and bearing five flowers in a lax deltoid raceme. Sepals and stamens not seen. Achene suborbicular, compressed, $\frac{1}{2}$ in. long, obscurely stipitate, with a densely plumose, curved, persistent style above an inch long.—Ibara country. Belongs to DeCandolle's first group of the section *Flammula*, near *C. Vitalba*.

CLEMATIS (§ FLAMMULA) STRIGILLOSA, *Baker*, n. sp.

A climber, with slender branches, the young ones clothed with dense, short, brown pubescence. Leaves pinnately trifoliolate; petiole above an inch long; leaflets ovate or ovate-oblong, acute, cuneate at the base, crenate, rigidly subcoriaceous, 3-4 in. long, obscurely hispid on the upper surface when mature, nearly glabrous beneath, with raised veins and veinlets. Inflorescence a very lax few-flowered panicle, terminal on the branches, the forks from the axils of the fully-developed leaves bearing 3-9 distant flowers. Sepals oblong, obtuse, whitish, densely pilose on the outside, under an inch long. Stamens nearly as long as the sepals. Style in the flowering stage $\frac{1}{2}$ in. long, densely plumose.—Tanala. Gathered also by Dr. Meller in 1862 in the Anevoca valley, between Tamatave and Antananarivo; and a nearly allied species, with 5-foliolate leaves with smaller entire leaflets, by Bojer in woods at Mazangay. It is a near ally of the only Mauritian species, *C. mauritiana*, Lam.

CLEMATIS OLIGOPHYLLA, *Hook. Ic. t. 80*. Mr. Kitching's fine range of specimens from the Ankaratra mountains show clearly that this is a variety, with lacinated leaflets, of *C. trifida*, *Hook. Ic. t. 79*.

NYPHÆA STELLATA, *Willd.* Between Tamatave and Antananarivo.

APHLOIA THEÆFORMIS, *Bennett*. Ankaratra mountains and between Tamatave and Antananarivo.

POLYGALA VOLUBILIS, *Bojer*. Ankaratra mountains.

GOMPHIA DELTOIDEA, *Baker*, n. sp.

A tree or shrub, glabrous in all its parts. Stipules deciduous; petiole very short; blade oblanceolate-oblong, acute, cuneate at

the base, finely serrated, rigid in texture, glossy on both surfaces, 3-4 in. long. Flowers in a sessile deltoid terminal panicle about as long as the leaves; pedicels strict, glabrous, $\frac{1}{4}$ - $\frac{1}{2}$ in. long; bracts minute, lanceolate. Sepals oblong, subacute, much imbricated, under $\frac{1}{4}$ in. long. Petals obovate-euneate, bright yellow, half as long again as the sepals. Filaments nearly obsolete; anthers half as long as the petals, erect, connivent, dehiscing by a distinct pore at the side of the tip of each cell. Style a little protruded from the calyx. Fruit not seen.—Between Tamatave and Antananarivo. Three Madagascar species of this genus are figured in DeCandolle's memoir on the Ochnaceæ. The present plant comes nearer the common Asiatic *G. angustifolia* than any of these, differing in the more distinct serrations of the leaves and fewer larger flowers to a panicle.

CALODRYUM TUBIFLORUM, *Desv.* Mr. Kitching's excellent specimens from the Ibara country show clearly that the petals are perfectly free when the flower expands, so that the genus cannot be maintained as distinct from *Quivisia*, with which C. DeCandolle has united it in his recent monograph.

VITIS (§ *CISSUS*) *MICRODIPTERA*, *Baker*, n. sp.

A shrubby climber, nearly glabrous in all its parts. Stems slender, angular, striated; tendrils much curved spirally above the base, simple, margined by a couple of narrow crisped wings. Leaves deltoid, bipinnate, immature at the flowering time, distinctly petioled, thin in texture, green on both sides; leaflets ovate-acuminate, inciso-serrate, placed singly on the main rachis, except the lowest, which are opposite, ternate, and distinctly stalked. Flowers in a dense cyme 3-4 inches broad, on a short stout leaf-opposed peduncle; bracts obsolete; pedicels erect, $\frac{1}{2}$ - $\frac{3}{4}$ in. long. Flowers tetramerous. Calyx green, glabrous, truncate, patellæform, $\frac{1}{2}$ - $\frac{3}{4}$ lin. diam. Bud oblong. Petals bright red, $\frac{1}{2}$ in. long, falling without expanding. Style filiform, under $\frac{1}{2}$ in. long.—Ankaratra mountains, gathered previously by Mr. Pool. Marked from all the Tropical-African species by its pinnate leaves.

INDIGOFERA BOJERI, *Baker*, n. sp.

A copiously-branched shrub, with slender, stiff, terete twigs, thinly clothed with adpressed white hairs. Leaves about $\frac{1}{2}$ in. long; petiole very short; stipules minute; leaflets 9-11, oblanceolate, often complicate, obtuse with a cusp, narrowed gradually

to the base, firm in texture, $\frac{1}{8}$ – $\frac{1}{3}$ in. long, thinly coated on both sides with adpressed white bristly hairs. Flowers in copious capitate racemes about as long as the leaves; pedicels finally $\frac{1}{8}$ – $\frac{1}{2}$ in. long; bracts minute, deciduous. Calyx campanulate, $\frac{1}{2}$ in. long, clothed with adpressed black and white hairs; teeth lanceolate, as long as the tube. Corolla purple, $\frac{1}{4}$ in. long; blade of the standard nearly orbicular. Pod straight, brown, subterete, thinly bristly, about $\frac{1}{2}$ in. long, many-seeded.—Ankaratra mountains. Gathered previously by Bojer and Lyall, and distributed by the former under the manuscript name of *I. polyphylla*, but quite different from the Indian plant so called by DeCandolle. It does not fit into any of the groups defined in the 'Flora of Tropical Africa,' having the narrow leaves of the *Stenophylla* in combination with a shrubby habit and congested capitate racemes.

INDIGOFERA LEUCOCLADA, *Baker*, n. sp.

A shrub, with pale, slender, glabrous woody branches. Leaves $\frac{3}{4}$ –1 in. long; petiole very short; stipules minute; leaflets 7, oblanceolate-oblong, alternate, petiolulate, obtuse, with a minute cusp, green and glabrous on both sides, the upper $\frac{1}{4}$ – $\frac{1}{3}$ in. long, the lower smaller, suborbicular. Flowers in copious congested racemes about as long as the leaves; bracts minute, linear; pedicels under $\frac{1}{2}$ in. long. Calyx obliquely campanulate, $\frac{1}{2}$ lin. long; teeth linear or deltoid-cuspidate, shorter than the tube. Corolla purple, glabrous, $\frac{1}{8}$ – $\frac{1}{3}$ in. long; blade of the standard obovate. Staminal tube as long as the corolla. Ovary linear, multiovulate. Pod not seen.—Ankaratra mountains. Belongs to the section *Tinctoria*, near *I. Schimperii*, Jaub. & Spach. A much smaller species, not at all argenteous.

DESMODIUM SCALPE, *DC.* Betsileo country.

D. OXYBRACTEUM, *DC.* Between Tamatave and Antananarivo.

CLITORIA LASCIVA, *Bojer.* Between Tamatave and Antananarivo.

STRONGYLODON MADAGASCARIENSIS, *Baker*, n. sp.

A shrubby climber, glabrous in all its parts. Leaves pinnately trifoliolate; petiole $1\frac{1}{2}$ –2 in. long; leaflets obovate or oblong cuspidate, entire, rather rigid in texture, green on both sides, $1\frac{1}{2}$ –2 in. long; stipellæ minute, persistent, subulate. Flowers in dense lateral racemes about 3 in. long, with tumid nodes, bearing each a pair of flowers; peduncle as long as the raceme; pedicels slender, an inch long. Calyx green, campanulate, $\frac{1}{4}$ – $\frac{1}{3}$ in. long;

teeth very short. Corolla red; standard reflexing, the oblong acute blade an inch long; wings standing forward, oblique oblong, more than half as long as the standard; keel half as long again as the standard, narrowed gradually into an acute incurved beak. Style and stamens reaching into the beak of the keel.—Between Tamatave and Antananarivo. A striking plant, with flowers rather like those of *Olianthus puniceus*. There are only two or three species known previously, in Ceylon and Polynesia.

DICHOSTACHYS TENUIFOLIA, *Benth.* Ankaratra mountains.

RUBUS ROSÆFOLIUS, *Smith.* Between Tamatave and Antananarivo.

BREXIA MADAGASCARIENSIS, *Thouars.* Between Tamatave and Antananarivo.

BRYOPHYLLUM CALYCINUM, *Salisb.* Between Tamatave and Antananarivo.

KITCHINGIA, *Baker*, genus novum. Nat. Ord. *Crassulaceæ*.

Flowers tetramerous. Calyx small, gamosepalous, campanulate, the deltoid or deltoid-orbicular segments as long as the tube. Corolla gamopetalous, tubuloso-campanulate, the 4 orbicular or deltoid-orbicular segments much shorter than the tube. Stamens 8, slightly biseriate, inserted at above the middle of the corolla-tube; filaments filiform; anthers minute, globose. Carpels of the pistil 4, free, diverging; ovaries small, oblong, multiovulate; styles filiform, long, slender; stigma capitate; hypogynous scales minute, quadrate, truncate. Follicles small, oblong, membranous, many-seeded.—Succulent perennial glabrous herbs, with flexuose stems, numerous opposite sessile or petioled crenate fleshy cauline leaves, and large bright-red flowers in lax terminal cymes. Allied to *Bryophyllum*, from which it recedes by its small calyx and divergent carpels.

KITCHINGIA GRACILIPES, *Baker.* (Plate VII.)

Stems slender, terete, flexuose from a decumbent base, $\frac{1}{2}$ –1 ft. long, sending out root-fibres from the lower nodes. Leaves opposite, oblong, obtuse, shortly petioled, about an inch long, cuneate at the base, deeply crenate. Flowers 3–6, in a lax terminal cyme; bracts very minute; pedicels very slender, $\frac{1}{2}$ – $\frac{3}{4}$ in. long, thickened beneath the calyx. Calyx $\frac{1}{8}$ in. long, the semiorbicular obtuse segments as long as the tube. Corolla bright red, 1–1 $\frac{1}{4}$ in. long, the tube broadest at the middle, where it is half an inch in diameter; segments semiorbicular, $\frac{1}{8}$ in. long. Stamens inserted just below the throat of the tube, those opposite the corolla-segments

a little higher than the other four; filaments filiform, $\frac{1}{8}$ – $\frac{1}{2}$ in. long; anthers black, globose. Ovaries oblong, $\frac{1}{2}$ in. long, cuneate at the base and apex; styles very slender, nearly an inch long; stigma minute, capitate.—Betsileo-land, on trunks of trees in the forests.

KITCHINGIA CAMPANULATA, *Baker*.

Stems stouter than in the other species, terete, flexuose. Leaves sessile, linear-oblong, obtuse, cuneate at the base, conspicuously crenate, 2–3 in. long. Flowers 12–20, in a lax globose compound terminal cyme; bracts minute, linear; pedicels $\frac{1}{2}$ – $\frac{3}{4}$ in. long. Calyx $\frac{1}{4}$ in. long; segments deltoid, subacute, rather longer than the tube. Corolla bright red, $\frac{3}{4}$ in. long, the tube broadest at the throat, where it is $\frac{1}{2}$ in. diam.; segments deltoid-orbicular, half as long as the tube. Stamens inserted about the middle of the corolla-tube; filaments filiform, $\frac{1}{4}$ – $\frac{1}{2}$ in. long; anthers minute, globose. Ovaries oblong, $\frac{1}{2}$ in. long; style rather longer than the ovary; stigma minute, capitate.—Betsileo-land.

COTYLEDON PANNOSA, *Baker*, n. sp.

Main stem creeping to a length of a foot, rooting from the nodes, terete, densely coated, like the leaves on both sides, with a thick mass of white woolly hairs, sending up short leafy branches, some of which terminate in an inflorescence. Leaves crowded towards the tips of the branches, opposite, decussate, oblong, entire, under an inch long, densely coated on both sides with persistent white hairs. Peduncle stiffly erect, under half a foot long, pubescent, furnished only with a single much-reduced leaf above the middle. Flowers few, tetramerous, arranged in a lax simple terminal cyme; bracts minute, lanceolate; pedicels erect, densely pubescent, about $\frac{1}{2}$ in. long. Calyx campanulate, pubescent $\frac{1}{4}$ – $\frac{1}{2}$ in. long; segments deltoid, acute, longer than the tube. Corolla red-purple, $\frac{1}{2}$ in. long; segments oblong-spathulate, minutely cuspidate, thinly cottony on the outside. Stamens inserted about the middle of the corolla-tube; filaments rather flattened, $\frac{1}{2}$ in. long; anthers minute, globose. Carpels with a linear-oblong ovary, $\frac{1}{8}$ in. long, narrowed gradually into a subulate style.—Ankaratra mountains. Remarkable in the genus for its creeping and rooting main stem, densely matted pubescence, and tetramerous flowers.

DROSERA RAMENTACEA, *Burchell* (*D. madagascariensis*, *DC.*).—Betsileo-land and Ankaratra mountains. Extends to the Cape, Angola, and Upper Guinea.

COMBRETUM PACHYCLADUM, *Baker*, n. sp.

A tree 20–30 feet high, with stout terete branchlets coated with brown tomentum. Leaves shortly petioled, opposite, oblong, obtuse, entire, rounded at the base, rigidly subcoriaceous, 4–6 in. long, glabrous on the upper surface, minutely pubescent beneath, with prominent veins and veinlets. Flowers in an ample terminal deltoid panicle, the lower branches of which are compound and subtended at the base by large leaves, the upper simple and subtended by small ones; racemes dense, subsecund, 1–3 in. long; pedicels spreading, $\frac{1}{2}$ – $\frac{3}{8}$ in. long; bracts minute, subulate. Flowers pentamerous. Calyx campanulate, $\frac{3}{8}$ in. long; teeth ciliated, deltoid, shorter than the glabrous tube. Petals oblong, bright crimson, twice as long as the calyx-teeth. Stamens 10, exserted $\frac{1}{8}$ – $\frac{1}{6}$ in. beyond the petals; filaments bright red; anthers small, oblong, versatile. Fruit not seen.—Between Tamatave and Antananarivo, where it was gathered by Dr. Meller in 1862. A near ally of the well-known *C. (Poivreæ) coccineum*, Lam., from which it differs by its small flowers, leaves rugose beneath, &c.

WOODFORDIA FLORIBUNDA, *Salisb.* Ibara country.*LAGERSTREEMIA MADAGASCARIENSIS*, *Baker*, n. sp.

A shrub, with slender, straight, terete, finely pubescent branchlets. Leaves oblanceolate, obscurely petioled, obtuse, with a minute cusp, narrowed gradually from the middle to the base, entire, rigidly subcoriaceous, an inch long, green, with minute black dots on the upper surface, whitish, with more copious and more distinct black dots beneath. Flowers pentamerous, in lax racemes, with leaves from the nodes; pedicels erecto-patent, $\frac{1}{2}$ – $\frac{3}{8}$ in. long. Calyx campanulate, not at all plicate, $\frac{1}{4}$ in. long, with a thin coating of white tomentum outside, and minutely dotted like the leaves; teeth deltoid, much shorter than the tube, spreading or reflexing. Petals oblong-unguiculate, bright mauve-purple, $\frac{1}{4}$ in. long. Stamens inserted low down in the calyx-tube, $\frac{1}{2}$ in. long; filaments erect, bright mauve-purple; anthers minute, globose, bright yellow. Style filiform, just overtopping the stamens; stigma capitate. Fruit not seen.—Ibara country. Adds this well-known genus of Tropical Asia to the flora of Madagascar. It is not known on the African continent.

DICHETANTHERA MADAGASCARIENSIS, *Triana*. Between Tamatave and Antananarivo.

ALBERTA LAURIFOLIA, *Baker*, n. sp.

A shrub or small tree, with slender terete branchlets, glabrous in all its parts. Leaves shortly petioled; stipules deltoid, scarious, deciduous; blade oblong or obovate-oblong, obtuse, entire, 1-2½ in. long, rigidly subcoriaceous, glossy and bright green above, paler beneath, with prominent veinlets. Flowers in dense cymes from the end of the branchlets and axils of the upper leaves; pedicels finally ¼-½ in. long. Calyx oblong-cylindrical, angled, ⅓ in. long; calyx-segments oblanceolate, obtuse, equal, persistent, finally ⅓ in. long, pale brown, conspicuously veined, moderately firm in texture. Corolla tubular, reddish, ½ in. long, with 5 deltoid contorted segments. Anthers 5, linear, hairy, inserted near the throat of the corolla-tube; filaments very short. Style much exerted from the corolla-tube.—Ankaratra mountains. This is the Madagascar species of the genus alluded to in the 'Genera Plantarum.' It was gathered long ago by Bojer, who says on his label that the Malagash name for the tree is "La-loona." The only other species known is a plant of the Cape.

VERNONIA (§ *DECANEURUM*) *TANALENSIS*, *Baker*, n. sp.

A shrub, with slender terete branchlets, clothed with dense short brown silky pubescence. Leaves alternate, distinctly petioled, broad oblong, acute, cuneate at the base, 2-3 in. long, minutely dentate, moderately firm in texture, nearly glabrous above, thinly matted with persistent brownish silky pubescence beneath. Heads 12-20, in a dense terminal corymb on short ascending pubescent pedicels ⅓-½ in. long. Involucre hemispherical, under ¼ in. diam.; bracts 3-4-seriate, lanceolate, the outer rows gradually smaller, dull brown, thinly pubescent. Achenia multicositate, only seen immature; pappus of about 30 whitish shortly ciliated setæ under ¼ in. long. Corolla purple, with a tube as long as the pappus and a funnel-shaped limb with linear segments. Style-arms 1 line long.—Tanala. Allied to the Abyssinian *V. Hochstetteri*, Schultz Bip.

CENTAUBOPSIS FRUTICOSA, *DC.* Tanala.*SENECIO MICRODONTUS*, *Baker*, n. sp.

A glabrous herbaceous perennial, with erect stems a foot or a foot and a half long, simple below the inflorescence. Lower leaves crowded near the base of the stem, simple, oblong-spathulate, obtuse, minutely inciso-crenate, the lowest almost petioled, but

dilated at the base, 3-4 in. long, those next above them oblong-lanceolate, amplexicaul, those of the upper part of the stem much smaller, lanceolate-acuminate. Heads 4-12, in a dense or lax terminal corymb. Involucre campanulate, $\frac{1}{4}$ in. diam., with a few linear outer bracts, besides the equal main ones, which are linear, glabrous, with a paler border on each side of the green keel. Outer flowers with a yellow ligule as long as the involucre. Achene $\frac{1}{8}$ - $\frac{1}{6}$ in. long, pubescent, with five strong ribs; pappus soft, white, caducous, as long as the achenes.—Ankaratra mountains. Gathered previously by Bojer in the province of Emirna. Nearly allied to the Cape *S. coronatus*, Harv. (*Cineraria*, Thunb.).

GERBERA PODOPHYLLA, *Baker*, n. sp.

An acaulescent perennial herb, with a densely silky rootstock. Leaves 4-6 in a radical rosette; petiole 1-1 $\frac{1}{2}$ in. long, clothed with dense, short, spreading hairs; blade oblong, subentire, rounded at the base, 1 $\frac{1}{2}$ -2 in. long, moderately firm in texture, hairy principally on the midrib beneath. Scape about a foot long, clothed throughout, especially just below the solitary capitulum, with soft pale brown, spreading hairs. Involucre campanulate, $\frac{1}{2}$ in. diam.; bracts few, linear, subequal, densely silky. Achenes only seen immature, glabrous, cylindrical. Outer flowers pistillate only, with a bright yellow ligule $\frac{1}{3}$ in. long. Pappus $\frac{1}{2}$ - $\frac{1}{4}$ in. long, composed of very copious soft white setæ. Disk-florets pale yellow, hermaphrodite, with a tube as long as the pappus and short bilabiate limb.—Ankaratra mountains. Nearly allied to *G. abyssinica*, Schultz Bip. The widely-spread *G. piloselloides*, Cass., which is common to the Cape, Tropical Africa, and the Himalayas, also occurs on the mountains of Madagascar.

LEUCOTHOE LITTORALIS, *DC.* Ankaratra mountains.

MÆSA LANCEOLATA, *Forsk.* Tanala.

BADULA LAURIFOLIA, *Bojer.* Between Tamatave and Antananarivo.

JASMINUM KITCHINGII, *Baker*, n. sp.

A shrub, with slender terete branchlets, finely pubescent in an early stage. Leaves opposite, nearly sessile, pinnate; leaflets 7-9, oblong or the end one obovate, obtuse, cuspidate or emarginate, $\frac{1}{2}$ -1 in. long, rather firm in texture, green and glossy on both sides, slightly pubescent beneath. Flowers 8-12 in a terminal

corymb, and also singly from the axils of some of the upper leaves, on long slender erect pedicels. Calyx $\frac{1}{3}$ in. long, the 6 linear teeth half as long as the campanulate tube. Corolla white, with a cylindrical tube $\frac{1}{2}$ – $\frac{5}{8}$ in. long, and 6 lanceolate, acute, contorted patent segments nearly as long. Anthers sessile at the dilated top of the corolla-tube.—Betsileo-land. Allied to the Abyssinian *J. floribundum*, R. Br., from which it differs by its subsessile leaves, more numerous leaflets, and short calyx-teeth.

VINCA LANCEA, *Bojer*. Ankaratra mountains and Betsileo country.

STRYCHNOS SPINOSA, *Lam*. Between Tamatave and Antananarivo.

CHIRONIA MADAGASCARIENSIS, *Baker*, n. sp.

A herbaceous perennial, much branched from the crown of the root, with slender, square, finely pubescent stems not more than 2–3 in. long. Leaves subsessile, oblong, acute, entire, cuneate at the base, about $\frac{1}{2}$ in. long, nearly glabrous. Flowers pentamerous, solitary, erect, terminal, rarely axillary, on slender ascending pedicels $\frac{1}{4}$ – $\frac{1}{2}$ in. long. Calyx green, glabrous, $\frac{1}{3}$ in. long, with a short funnel-shaped tube and 5 large lanceolate segments. Corolla pink, rotate, with a tube as long as the calyx and 5 oblique, oblong, obtuse spreading segments $\frac{1}{3}$ – $\frac{1}{2}$ in. long. Anthers linear-oblong, erect, connivent, a third as long as the corolla-segments, not twisting up when mature. Capsule ampullæform, glabrous, rather longer than the calyx.—Between Tamatave and Antananarivo. Adds this well-known Cape genus to the Madagascar flora.

TACHIADENUS CABINATUS, *Griseb*. Between Tamatave and Antananarivo.

LIMNANTHEMUM INDICUM, *Griseb*. Ankaratra mountains.

SOPUBIA MADAGASCARIENSIS, *Benth*. Between Tamatave and Antananarivo.

HALLERIA LIGUSTRIFOLIA, *Baker*, n. sp.

A much-branched shrub, glabrous in all its parts, with quadrangular branchlets. Leaves opposite, shortly petioled, oblong, obtuse, minutely cuspidate, subentire, 1–1 $\frac{1}{2}$ in. long, rigidly coriaceous, green on both sides. Flowers in sessile umbels from the axils of the leaves, on slender glabrous pedicels $\frac{1}{4}$ – $\frac{1}{3}$ in. long, which

are usually without bracteoles, but have rarely one or two minute ones. Calyx broadly campanulate, $\frac{1}{2}$ in. long, firm in texture, green, with 5 obscure subdeltoid teeth. Corolla oblong from a cylindrical base, bright red, $\frac{3}{4}$ – $\frac{7}{8}$ in. long, the lobes short and obscure. Stamens 4, exserted, the filiform filaments inserted at the throat of the contracted lower portion of the corolla-tube; anthers with 2 small, oblong, divaricating lobes. Style filiform, about an inch long.—Betsileo-land. This is not the undescribed Madagascar species mentioned in the 'Genera Plantarum,' ii. 936, which has smaller, ovate, distinctly dentate leaves and conspicuous calyx-segments, and is closely allied to *H. elliptica*, Linn., of the Cape.

COLEA FLORIBUNDA, Bojer. Between Tamatave and Antananarivo.

KIGELIA MADAGASCARIENSIS, Baker, n. sp.

A shrub with the leaves in a rosette at the tip of the branchlets, not fully developed at the flowering-time, distinctly petioled, imparipinnate; leaflets 7-jugate, oblanceolate, slightly pubescent, the lowest binate. Flowers 6–10 in a corymbose cyme at the end of the branchlets; pedicels cernuous, $\frac{1}{2}$ –1 inch long; bracts minute, deltoid, deciduous. Calyx campanulate, glabrous, an inch long; segments semiorbicular, shorter than the tube. Corolla infundibuliform, bright red, 3–3 $\frac{1}{2}$ in. long; tube dilated gradually from the base to a throat above an inch in diameter, pilose at the insertion of the stamens; segments subequal, oblong, obtuse, under an inch long. Stamens 4, decurved, inserted near the base of the tube, reaching to its throat; filaments filiform, above an inch long; anthers cordate-ovate, obtuse, versatile, $\frac{1}{3}$ in. long. Ovary cylindrical; style reaching up to the anthers; stigma with two oblong lamellæ.—Ibara country. Differs from *K. ethiopica*, Dcne. in Deless. Ic. vol. v. t. 93 A, by its more numerous leaflets, the lower ones binate, corolla-tube dilated gradually from the base to the throat, and corolla-segments about half an inch broad.

PHYLLAETHRON BOJERIANUM, DC. Betsileo-land.

MIMULOPSIS SPECIOSA, Baker, n. sp.

A diffuse herbaceous perennial, with square stems, conspicuously constricted above the nodes, the young branches clothed with short dense glandular pubescence. Leaves petioled, oblong-

lanceolate, acute, glabrous, finely deutate. Flowers in an ample terminal panicle with spreading, few-flowered, secund, glandulose, slender branches, with small oblong bracts similar to the leaves in texture, produced at the base of the primary and secondary pedicels. Calyx $\frac{1}{2}$ in. long, densely glandular-pubescent, cut down nearly to the base into linear segments. Corolla glabrous, bright yellow, twice as long as the calyx, with an oblique oblong decurved tube nearly half an inch in diameter, and 5 small orbicular, subequal, ascending segments. Stamens 4, included, arcuate, inserted about the middle of the corolla-tube. Style filiform, as long as the corolla. Capsule oblanceolate, glabrous, rather longer than the calyx.—Betsileo-land and Tanala. Two Madagascar species of the genus have been gathered previously.

CLEODENDRON MACROCALYCINUM, *Baker*, n. sp.

Shrubby, glabrous in all its parts. Leaves shortly petioled, oblong-lanceolate, acute, entire, moderately firm in texture, green on both sides, 2-3 in. long. Flowers in a lax terminal panicle, with cymose branches; bracts minute, linear; pedicels slender, ascending, $\frac{1}{4}$ - $\frac{1}{2}$ in. long. Calyx oblong, glabrous, half an inch long; segments 5, deltoid. Corolla subrotate, with a cylindrical tube twice as long as the calyx, and 5 nearly equal spreading, obovate, obtuse segments half an inch long. Stamens 4, reaching to the top of the limb; anthers minute, oblong. Style filiform, nearly 2 in. long, cleft at the stigmatic apex. Fruit not seen.—Tanala. Remarkable in the genus for its very large calyx and nearly equal corolla-segments.

SALVIA CRYPTOCLADA, *Baker*, n. sp.

A shrub, with long, straight, finely pubescent, wand-like branches, entirely hidden by the ascending leaves. Leaves crowded up to the base of the raceme, sessile, oblanceolate-oblong, subobtusate, minutely crispato-crenulate, 1-1 $\frac{1}{2}$ in. long, rigidly coriaceous, green, rugose, and shortly pubescent on the upper surface, densely matted with persistent white tomentum beneath. Raceme moderately dense, 2-3 in. long, the flowers about four in a whorl; pedicels $\frac{1}{2}$ in. long; bracts small, oblong-lanceolate, leaf-like in texture. Calyx under $\frac{1}{2}$ inch long, green or purple, finely glandular-pubescent; upper lip $\frac{1}{4}$ in. long, with three lanceolate-cuspidate teeth; lower lip with two large lanceolate-acuminate teeth. Corolla reddish, 1-1 $\frac{1}{4}$ in. long, the tube dilated gradually from

the base to a throat $\frac{1}{4}$ in. diam.; upper lip oblong, $\frac{1}{3}$ in. long; lower as long, with a deltoid central lobe. Stamens protruding a little from the corolla; upper arcuate fork of the connective $\frac{1}{3}$ in. long; lower deflexed, $\frac{1}{8}$ in. long, polliniferous at the tip. Style arcuate, a little longer than the stamens.—Ankaratra mountains. This and the three following species are nearly allied. They quite correspond with the section *Euspace* of the subgenus *Salvia* proper, as defined by Bentham in the 'Genera Plantarum,' except that they have not the ring of hairs at the insertion of the stamens inside the corolla-tube, as in *S. officinalis* and other well-known species of the Mediterranean region.

SALVIA LEUCODERMIS, *Baker*, n. sp.

A shrub, with long, slender, wand-like branches, which are quite hidden by the crowded ascending leaves, and thinly coated with white tomentum, like that of their under surface. Leaves subsessile, oblanceolate-oblong, obtuse, minutely crenulate, not more than an inch long, rigidly coriaceous, pale green, and thinly tomentose on the upper surface, not rugose, as in the last species, matted with adpressed, thin, white, persistent tomentum beneath. Raceme sessile, 2-3 in. long, the flowers 5-6 in a whorl; pedicels $\frac{1}{8}$ - $\frac{1}{6}$ in. long, erecto-patent; bracts deltoid, connate at the base. Calyx $\frac{1}{2}$ in. long, densely glanduloso-pilose; tube infundibuliform; upper lip $\frac{1}{8}$ in. long, with 3 lanceolate-deltoid teeth, the central one the smallest; lower lip with two larger deltoid-cuspidate teeth. Corolla whitish, 15-16 lines long, the tube dilated gradually from the base to a throat $\frac{1}{3}$ inch in diameter; upper lip suborbicular, $\frac{1}{8}$ in. long; lower $\frac{1}{3}$ in. long, deflexed, with a cuneate central segment $\frac{1}{3}$ in. broad. Stamens just exerted from the upper lip of the corolla; arcuate upper fork of the connective $\frac{1}{4}$ in. long, including the anther; lower fork short, deflexed, polliniferous at the tip. Style arcuate, filiform, a little longer than the stamens.—Betsileo country.

SALVIA SESSILIFOLIA, *Baker*, n. sp.

A shrub, with slender woody branches, densely clothed with short, spreading, whitish hairs. Leaves sessile, crowded, spreading or ascending, oblanceolate-spathulate, subobtuse, crispato-crenulate, 1-1 $\frac{1}{2}$ in. long, moderately firm in texture, green, rugose, and shortly pubescent on the upper surface, thickly matted with persistent white tomentum beneath. Raceme sessile, terminal, 2-3 in. long, the flowers 4-6 in a whorl; pedicels erecto-patent, $\frac{1}{2}$ in. long;

bracts ovate or lanceolate, leaf-like in texture, the lower as long as the calyx. Calyx infundibuliform, pubescent, $\frac{1}{2}$ in. long, green or purple; upper lip $\frac{1}{2}$ in. long, with three deltoid teeth with long cusps; lower lip with two larger lanceolate-acuminate teeth. Corolla red, 1-1 $\frac{1}{4}$ in. long, slightly pubescent, the tube gradually dilated from the base to a throat $\frac{1}{4}$ in. diam.; upper lip oblong, cucullate, $\frac{1}{3}$ - $\frac{1}{2}$ in. long; lower lip shorter, deflexed, with a broad cuneate central lobe. Stamens considerably exerted from the upper lip of the corolla; arcuate upper fork of the connective about $\frac{1}{2}$ in. long; lower fork short, deflexed, polliniferous at the tip. Style arcuate, protruded beyond the anthers.—Ankaratra mountains.

SALVIA PORPHYROCALYX, *Baker*, n. sp.

A shrub, with slender terete branches, densely clothed with short spreading whitish hairs. Leaves sessile, ascending, oblong, subobtuse, crispato-crenulate, about an inch long, moderately firm in texture, green, rugose, and slightly setose on the upper surface, densely clothed with whitish hairs beneath. Raceme sessile, about 3 inches long and broad; flowers about 4 in a whorl; pedicels short, densely pubescent; bracts ovate or oblong, similar to the leaves in texture, the lowest as long as the calyx. Calyx $\frac{1}{2}$ in. long, broadly funnel-shaped, bright purple, pubescent; upper lip $\frac{1}{2}$ in. long, with a truncate limb and 3 small, distant, linear-subulate teeth from a broad base; lower lip with two larger lanceolate acuminate teeth. Corolla whitish, 1 $\frac{1}{2}$ in. long, finely pubescent, the tube $\frac{1}{3}$ in. diam. at the throat; upper lip semicircular, $\frac{1}{4}$ in. long and broad; lower deflexed, with an orbicular-cuneate central segment $\frac{2}{3}$ in. broad. Stamens just exerted from the upper lip of the corolla; upper arched fork of the connective $\frac{1}{3}$ in. long; lower shorter, deflexed, polliniferous at the end. Style acuminate, protruded a little beyond the anthers.—Ankaratra mountains.

LORANTHUS (§ *DENDROPTHOE*) *HOYÆFOLIUS*, *Baker*, n. sp.

Branches pale, terete, rugose, with copious lenticels. Leaves opposite, shortly petioled, obovate-oblong, obtuse, entire, cuneate at the base, 1 $\frac{1}{2}$ -2 in. long, very thick in texture, coriaceous, green on both sides, glabrous, the veins entirely hidden. Flowers 3-8, in copious sessile clusters in the axils of the leaves. Bracteole oblique, cupular, with a ciliated deltoid apex. Calyx glabrous, $\frac{1}{2}$ in. long, with an oblong tube and 5 deltoid teeth.

Corolla 18–21 lin. long, clavate in bud, finally slit down one side below the middle; teeth 5, linear-spathulate, $\frac{1}{8}$ in. long. Anthers linear, basifixed, $\frac{3}{8}$ – $\frac{1}{2}$ in. long; filaments very short, inserted at the throat of the corolla-tube. Style very slender, longer than the corolla.—Betsileo-land. Closely allied to the next species, the Mauritian *L. Bojeri*, and Seychelles *L. seychellensis*.

LORANTHUS LENTICELLATUS, *Baker*, n. sp.

Branches slender, pale, terete, rugose, with copious lenticels. Leaves opposite, shortly petioled, oblong-lanceolate, acute, cuneate at the base, $1\frac{1}{2}$ –2 in. long, entire, moderately thick in texture, green and glabrous on both sides. Flowers 1–3 from the axils of the leaves, on short pedicels. Bracteole minute, cupular, with a deltoid tip. Calyx glabrous, $\frac{1}{12}$ in. long, with an oblong tube and 5 minute orbicular teeth. Corolla spathaceous, $1\frac{1}{2}$ in. long, finally slit down one side below the middle; teeth 5, minute, orbicular. Anthers linear, $\frac{1}{2}$ in. long, inserted below the throat of the tube, nearly sessile. Style about as long as the corolla.—Tanala.

EUPHORBIA (§ *RHIZANTHIUM*) *PRIMULÆFOLIA*, *Baker*, n. sp.

Stem tuberous, fleshy, oblong-cylindrical, 2–3 in. long, with a brown epidermis. Leaves 4–6 in a tuft at the summit of the stem; petiole short, crisped at the margin, dilated at the base; blade obovate-oblong, obtuse, cuneate at the base, subentire, 1– $1\frac{1}{2}$ in. long, rather coriaceous in texture, green on both sides, slightly pilose on the conspicuous reticulated veins beneath. Heads 2–3 in a cluster at the summit of erect peduncles shorter than the leaves. Involucre campanulate, $\frac{1}{2}$ in. long, clasped and hidden by a couple of pale-green cuneate-orbicular bracts, which wrap it tightly and envelop it; glands transversely oblong, not horned. Fruit glabrous.—Ankaratra mountains. A near ally of the well-known *E. tuberosa* of the Cape.

PHYLLANTHUS CASTICUM, *Müll. Arg.* Ankaratra mountains.

UAPACA CLUSIACEA, *Baker*, n. sp.

A shrub or tree, with puberulent, white, rather stout, terete branchlets. Leaves rather crowded, nearly sessile, oblanceolate-oblong, obtuse, cuneate at the base, entire, 2–3 in. long, rigidly coriaceous, glabrous on both surfaces, with erecto-patent main veins. Male flowers in a globose head $\frac{1}{2}$ in. diam., placed on a stiff erect peduncle $\frac{1}{2}$ – $1\frac{1}{4}$ in. long, surrounded by an involucre of

about 6 unequal, persistent, much imbricated, orbicular or obovate-oblong reflexing bracts. Perianth infundibuliform, $\frac{1}{2}$ lin. long, consisting of 5 orbicular-cuneate segments, which are similar in texture to the bracts of the involucre. Stamens 5, exerted; filaments flattened; anthers oblong. Pistil rudimentary in the male flower. Female flowers and fruit unknown.—Ankaratra mountains.

HYDROSTACHYS VERRUCULOSA, *A. Juss.* Tanala.

H. IMBRICATA, *A. Juss.* Tanala.

H. GOUDOTANA, *Tulasne.* Tanala and Betsileo country.

URERA RADULA, *Baker*, n. sp.

A tree or shrub, with stout terete branchlets, with a brown bristly epidermis. Leaves crowded at the end of the branches; stipules large, brown, deltoid, scariose, persistent; petiole $1\frac{1}{2}$ –2 in. long, densely armed with minute pellucid stinging bristles; blade cordate, half a foot long and broad, bipinnatifid, acute, the secondary lobes reaching about halfway down to the midrib, conspicuously crenate, the upper surface dark green, very rugose, and minutely bristly, especially on the main veins; the under surface similarly bullate and bristly. Flowers in a bipinnate sessile panicle shorter than the leaves; rachises slender, densely bristly. Flowers sessile, pentamerous, male only seen; bud depressoglobose, brown, glabrous. Sepals obovate-cuneate, $\frac{1}{2}$ lin. long. Stamens included.—Betsileo-land.

OTTELIA LANCIFOLIA, *A. Rich.* Between Tamatave and Antananarivo.

APONOGETON QUADRANGULARE, *Baker*, n. sp.

Root-stock tuberous. Petiole not above a few inches long in the specimens; lamina lorate, a foot or a foot and a half long, $1-1\frac{1}{4}$ in. broad, obtuse, moderately firm in texture, narrowed gradually from the middle to the base, with distinct vertical ribs and distinct horizontal cross bars, the interspaces entirely filled up with parenchyma. Peduncle very thick, reaching a length of a couple of feet. Spikes about 6, crowded at the apex of the peduncle, cylindrical, 2–3 in. long, sometimes branched. Bracts none. Bracteoles minute, orbicular. Stamens 5–6; filaments filiform; anthers minute, yellow, globose. Carpels usually 3, shorter than the stamens in the flowering stage.—Tanala.

A. ULVACEUM, *Baker*, n. sp. Leaves entirely submerged, very

thin and membranous in texture, with a long petiole and a bright-green, crisped, lorate blade above a foot long, 2-3 in. broad, cuneate at the base, with a distinct midrib, the vertical veins distinct, the cross bars fine and close. Peduncle reaching a length of 2-3 feet. Spikes 2, cylindrical, simple, about 2 in. long; large bracts, like those of *A. distachyum*, entirely absent; bracteoles 2-3 to each flower, minute, oblong. Stamens 6-8, longer than the bracteoles; filaments linear-subulate; anthers minute, black, globose. Carpels 3-4, shorter than the stamens in an early stage of the flower.—Ankaratra mountains. Gathered previously by Dr. Lyall, from whose specimens the above description of the inflorescence and flower is taken.

RHODOCODON, *Baker*, genus novum Liliacearum.

Perianth gamophyllous, campanulate, the six equal deltoid, permanently erect, 1-nerved segments much shorter than the campanulate tube. Stamens 6, obscurely biseriate, inserted low down in the corolla-tube; filaments filiform, about equalling in length the lanceolate, erect, basifixed anthers, which do not reach to the summit of the perianth-tube. Ovary 3-celled, globose, sessile; ovules two in a cell, erect, collateral; style filiform, as long as the ovary; stigma capitate, obscurely tricuspidate. Fruit unknown, no doubt capsular.—A bulbous caulescent herb, with subulate leaves, a slender scape, small red, laxly racemose flowers, and peculiar small spurred bracts, like those of some of the *Urgineas*. Comes in between *Muscari* and *Urginea*.

R. MADAGASCARIENSIS, *Baker*. (Plate VIII.)

Bulb ovoid, under an inch in diameter, with white inner and thin grey outer tunics. Leaves as many as 6-7 to a bulb, subulate, glabrous, not seen fully developed. Scapes sometimes two to a bulb, reaching a foot in length, slender, terete, fragile, glabrous. Raceme laxly 6-12-flowered, 1-2 in. long, the upper flowers small and abortive; pedicels erecto-patent or cernuous, $\frac{3}{8}$ - $\frac{1}{2}$ in. long; bracts minute, persistent, bright red, with a lanceolate or deltoid lamina and a curved ligulate spur with reflexed edges, which in the lower bracts, but not in the upper, is longer than the lamina. Perianth campanulate, $\frac{1}{4}$ in. long, whitish at the base, bright red upwards; segments with a single central nerve, which is decurrent to the base of the tube. Anthers and style each about half a line long.—Ankaratra mountains and Ibara country.

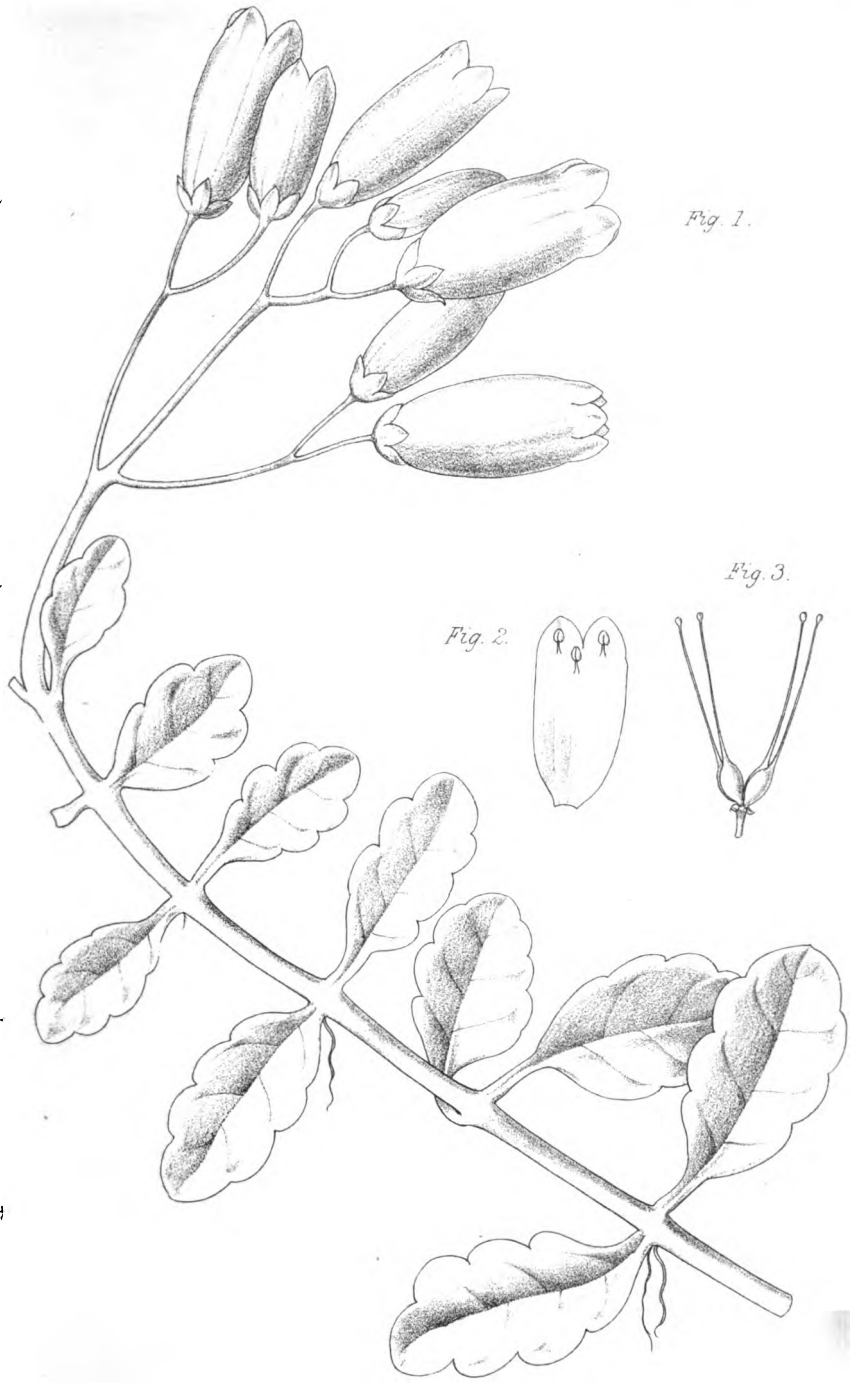

Fig. 1.

Fig. 3.

Fig. 2.

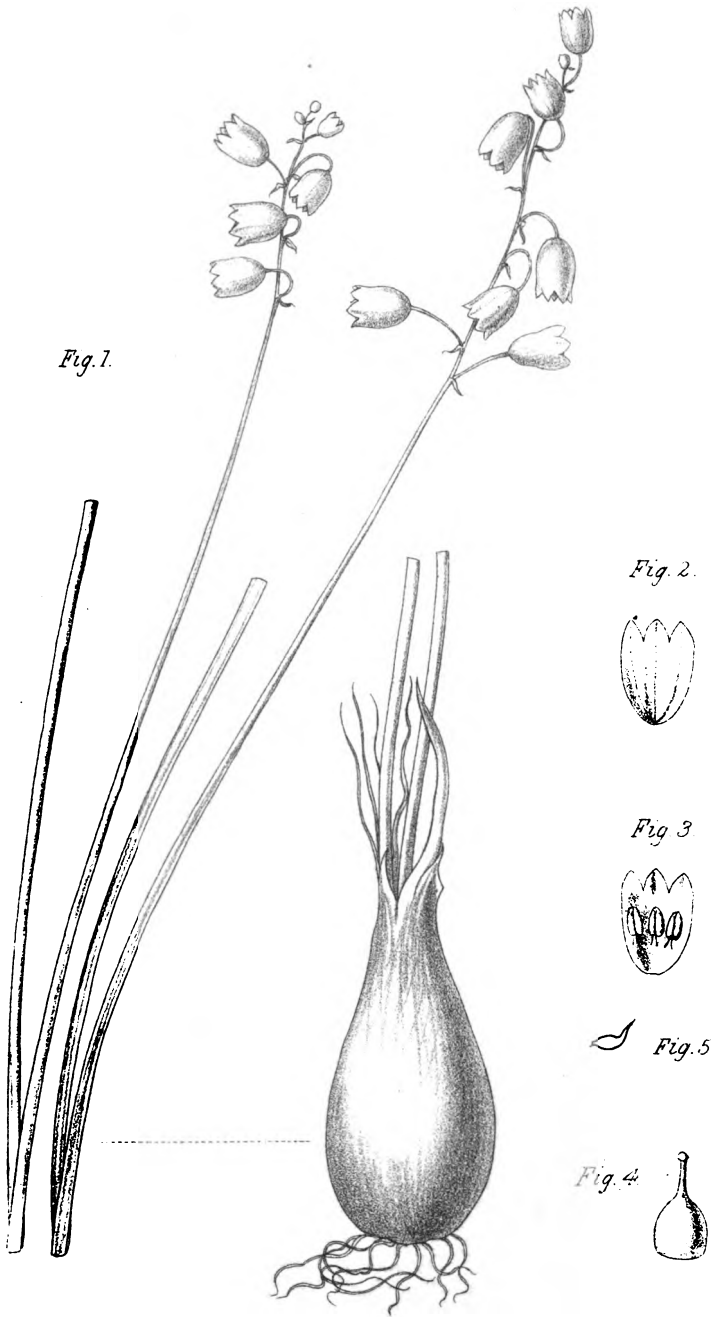

Fig. 1.

Fig. 2.



Fig. 3.



Fig. 5.

Fig. 4.



J.N.Fitch lith.

Fitch imp

RHODOCODON MADAGASCARIENSIS, Baker.

DESCRIPTION OF THE PLATES.

PLATE VII.

Fig. 1. *Kitchingia gracilipes*, Baker.

2. Section of the corolla, to show stamens and their insertion, nat. size.
3. The carpels, also of natural size.

PLATE VIII.

Fig. 1. *Rhodocodon madagascariensis*, Baker.

2. A section of the perianth, to show nerving and proportion of segments to tube, enlarged.
3. A section of the perianth, to show the stamens and their insertion, also enlarged.
4. The pistil, magnified.
5. The lower bract, also enlarged.

Notes on Orchidæ. By GEORGE BENTHAM, F.R.S.

[Read January 20, 1881.]

THE wonderful variety in the forms of tropical Orchidæ, and the singular complications of their fertilizing-apparatus, early caught the attention of several of the most eminent botanists; and in the latter portion of last century and the first decades of the present one we had already special treatises on them from Swartz, the two Richards (father and son), Dupetit-Thouars, Robert Brown, Blume, and others. The sagacious observations of Brown, backed by the splendid drawings of Bauer, induced Lindley to devote himself to the study of the Order, of which he became the great master. At the same time one of the results of the labours of the Horticultural Society was the general spread of a taste for the cultivation of tropical plants amongst the wealthy, and amongst these Orchidæ soon took a prominent place. Already, in the celebrated stoves of Loddiges of Hackney, a considerable number were successfully grown, and they began to appear in the then newly established Horticultural exhibitions. It was at one of these that the Duke of Devonshire, President of the Horticultural Society, was so struck with the singularity of the *Oncidium Papilio*, that he determined to form a special collection of the Order in the stoves at Chatsworth. This set

the fashion amongst the wealthy amateurs; and the amount of money now spent in the collection, importation, cultivation, and illustration of the innumerable showy forms would, if summed up, appear quite fabulous. At the same time, in a scientific point of view, the interest in the Order has been as much intensified by the investigations of Darwin, showing how important in the life-history of the several races are those singular modifications in the fertilizing-apparatus and its protecting perianth, which had till then only excited curiosity.

For the systematic arrangement of the several races of Orchidæ the preliminary labours of Swartz, published in the Transactions of the Academy of Stockholm for 1800, were excellent for the time, but became obsolete from the great influx of new forms unknown to him. Robert Brown, in the fifth volume of the second edition of Aiton's 'Hortus Kewensis,' and in his Prodrômus of the Australian Flora, first established the principles of their classification on a solid basis; and this was thoroughly worked out by Lindley, in as far as his materials allowed, in a variety of works, and the results summarized in his 'Genera and Species of Orchids,' many of the genera further revised, with the fresh materials received up to the years 1853 to 1855, in his 'Folia Orchidacea.' Since that time, notwithstanding the many eminent botanists who have worked at the Order, we have had no systematic digest of the genera and species so largely multiplied during the twenty-five or thirty years that have elapsed; and the greater number of the splendidly illustrated works on Orchidæ which have been published have been chiefly devoted to showy species, and almost always unaccompanied by any analysis exhibiting their generic characters. There are, however, some important exceptions; and in the first rank must be placed Blume's works. They all show, in whatever tribe of plants he took in hand, a wonderful acuteness and correctness of observation. His first great work, the 'Bijdragen tot de Flora van Nederlandsch Indië,' worked out and printed in Java without the aid of European herbaria and libraries, is exceptionally free from mistakes and blunders; and though many of his sections may have become genera, or some of his genera reduced to sections, yet they have almost all been adopted as distinct groups. In Orchidæ the portion of the fourth volume of his 'Rumphia,' and the splendid volume devoted to the Order, are as yet unsurpassed models of true botanical illustration.

Besides these, the best analyses of the generic characters are given in Sir William Hooker's 'Exotic Flora,' in some of the plates of the 'Botanical Magazine,' in the Illustrations of Wight and of Griffith, in the younger Hooker's Floras, in Fitzgerald's 'Australian Orchids,' and in a few of Lindley's illustrated works. I would also call attention to the excellent detailed exposition of the structure of the flower given in the fourth volume of the Memoirs of the Paris Museum (1818), under the title of "De Orchideis Europæis Adnotationes," by the elder Richard, who in this, as in all his other works, was much in advance of his time.

I now come to speak of the great Orchidologist of the present day, who took up the pen and pencil as they fell from the hands of Lindley, and who, having since devoted himself almost exclusively to the study of the Order, is now the only authority for the determination of species, especially for those in cultivation. I allude to the younger Reichenbach. No one has a richer collection of specimens than his, no one has more opportunities of examining the flowers in a living state, no one is more thoroughly acquainted with their peculiarities, or has better means of giving us a new Genera and Species of Orchidacæ; but unfortunately no such a one has as yet appeared, and I cannot learn that any one is in preparation. In his numerous publications he has proposed, modified, combined, or suppressed a large number of genera; but he has nowhere as yet given any synopsis of contrasted characters so as to give a clue to the principles upon which he would limit the tribes and genera he would adopt; so that whilst cordially agreeing in many of the changes he proposes, there are others for which I have failed to comprehend his reasons. He appears, for instance, generally to rely absolutely on floral characters, to the exclusion of vegetative ones, more on the absolute number than on the form and arrangement of the pollen-masses, and often to attach much more importance to the calli, lobes, and appendages of the labellum and column than I should do in respect of genera. I trust, however, he may yet give us a clue to his systematic views in time for use in the new part of our 'Genera Plantarum' now in preparation.

Dr. Pfister, of Heidelberg, has, on the other hand, taken up the study of Orchidæ according to their vegetative characters, the importance of which I did not fail to recognize as soon as I

began to consider the general arrangement of the Order. I am not aware that he has as yet published the results of his investigations; but on the occasion of his visit to Kew last spring he called my attention to various points which I had overlooked.

The general principles upon which Lindley divided the Order remain true to the present day, although his tribes may require some modification in detail, the distinctive characters having become better understood, and proving not near so constant as they appear at first sight, and their definitions, as generally received, often very vague, owing chiefly to the inaccuracy of some of the terms used. Some botanists have therefore recently proposed to overturn the system altogether; but I am not aware of any plausible one being substituted for it. J. G. Beer, of Vienna, in his 'Praktische Studien an der Familie der Orchideen,' 1854, a work chiefly horticultural, after strongly criticising Lindley's classification, proposes a division of the Order into six tribes founded solely on modifications of the labellum, to the total neglect of all other characters, structural or vegetative. He goes no further in his systematic arrangement, but gives under each tribe an alphabetical list of genera; where we find, for instance, *Orchis* and *Habenaria* in the second tribe associated with *Angræcum*, *Phaius*, *Calanthe*, *Corallorhiza*, and others, whilst *Serapias* and *Ophrys* are in the fifth tribe associated with *Oncidium*, *Luisia*, *Malaxis*, *Epipactis*, *Caladenia*, and others, resulting in the most incongruous medley conceivable. Nine years later, in his 'Beiträge zur Morphologie und Biologie der Orchideen,' a larger work, valuable for the accurate delineation and description of the capsules and seeds of all the species which he could obtain in fruit, and of the germination of several of them, he still insists on the value of his tribes, reducing them only from six to five, by the exclusion of *Cypripedium* from the order.

The Lindleyan system has been shortly summarized as follows:—

* *Pollen-masses waxy.*

Malaxideæ. No caudicle.

Epidendreeæ. One or two caudicles, but no gland.

Vandææ. One or two caudicles attached to a gland.

** *Pollen-masses granular or powdery.*

Ophrydeæ. Anther adnate to the top of the column.

Arethuseæ. Anther operculate, over the rostellum.

Neottieæ. Anther erect, behind the rostellum.

*** *Abnormal tribes.*

Cypripediæ. Anthers 2.

Apostasiæ. Anthers 2 or 3 ; ovary 3-celled.

The primary division, founded on the consistence of the pollen, has not been replaced by any other equally good, although it is by no means absolute. The waxy pollen-masses of some species of *Phaius* and *Bletia*, for instance, appear to be tardily formed, the granular mass of pollen sometimes filling the whole anther-cells; the powdery pollen of *Eriochilus*, *Acianthus*, and some others is almost consolidated into waxy masses; and the waxy masses of *Earina* and others will at length resolve themselves into powdery granules; but these exceptions are very rare, and almost isolated among the immense number of genera where the distinction is constant.

The distinctions, however, founded upon the so-called caudicles and gland can scarcely be maintained, independently of the confusion occasioned by the term *caudicle* having been applied to three very different parts of the pollinary system:—1. The true caudicle is the extension of the smaller end of a pollen-mass into a tail-like point, corresponding to the caudicle of the pollen-mass in *Asclepiadææ*. It is specially exemplified in most *Ophrydeæ*, and to a certain degree in a few other genera, such as *Liparis*, *Eria*, *Calanthe*, &c. It is a part of the pollen-mass, though often of a rather different consistence, and is included with it in the as yet unopened anther-cell. 2. The so-called caudicle of *Epidendrum* and its allies is, in like manner, included in the anther-cell before it opens, but does not form part of each distinct pollen-mass. It is a variously shaped mass of loosely connected pollen-grains, as variously attached to the two or four pollen-masses of each cell, to which it forms a sort of appendage, and might therefore, in technical descriptions, be distinguished from the caudicle by the term *appendicula*, which seems more appropriate than that of *caudicula spuria* given it by Blume. It may be sometimes so much reduced as to make its presence or absence very difficult to ascertain from dried specimens, and to have caused several genera to be alternately placed in *Malaxideæ* and in *Epidendreæ*; in other, often closely allied, genera it may

exceed in bulk the pollen-masses themselves. 3. The so-called caudicle in *Vandææ* is very different both in origin and substance; it forms no part of the pollen, nor even of the anther, but is a production of the upper surface or back of the rostellum, being a prolongation of the so-called gland or detachable disk of the rostellum. Darwin, distinguishing it from the caudicle, proposes to call it a *pedicel*, which would have been an appropriate term but for its universal use in descriptive botany for the special designation of the pedicel of a flower. The term *stipes* is equally appropriate, and has not the same inconvenience, for it is generally used as the support of any organ. The presence of this stipes, though general in *Vandææ*, is by no means universal, and traces of it may be found in genera belonging to other tribes. The tribe of *Vandææ* can, however, be maintained with advantage with very nearly the limits assigned to it by Lindley, but founded on other characters; but the *Malaxideæ* and *Epidendreæ* must be amalgamated, as already suggested by Lindley, and may be divided into several tolerably distinct subtribes.

Of the three tribes with granular or powdery pollen, that of *Ophrydeæ* remains as a very natural and perfectly distinct group as limited by Lindley, but requiring some little modification of the technical character; but the separation of *Arethuseæ* from *Neottieæ* has proved to be purely artificial, without even the advantage of a constantly definite distinctive character, although here again, as in *Epidendreæ*, several natural and tolerably well-characterized subtribes may be recognized.

In the small anomalous tribes *Cypripediæ* and *Apostasieæ* there is no alteration to propose other than their consolidation into a single one.

The result of a detailed examination of all the genera proposed or established of which I could procure specimens, living or dry, checked by published descriptions and illustrations, has been their distribution into five tribes, slightly modified from those of Lindley, and twenty-seven subtribes, of which I now give a short summary of the most essential characters, passing over for the present the exceptional forms. These exceptions will, I think, be found to be very few as connecting the tribes; but the subtribes are not always so definite, and it may be hoped that a further study of numerous forms of which we have at present only very imperfect materials may lead, in many respects, to considerable improvements in their circumscription.

I shall follow up this summary or conspectus with a few observations on the most important tribal and subtribal characters, and on the exceptions to them which have come under my notice, and on the genera I would include under each.

CONSPECTUS TRIBUUM (exceptis neglectis).

Tribus 1. *EPIDENDRÆ*. Anthera 1, postica, opercularis, sæpius incumbens, loculis distinctis parallelis. Pollinia cerea, 1-2-seriata, parallela, in quaque serie 2 v. 4 (in quoque loculo 1-4), libera v. visco parco v. appendicula granulosa in quoque loculo connexa, rarissime v. casu tantum rostello affixa.

Subtribus 1. *Pleurothallæ*. Caulis ebulbosus, folio unico et inflorescentia terminatus.

Subtribus 2. *Microstyleæ*. Anthera erecta v. prona, sæpe persistens nec incumbens.

Subtribus 3. *Liparidæ*. Inflorescentia terminalis. Pollinia 4, rarius 8, subæqualia, conferta, sæpius libera, inappendiculata.

Subtribus 4. *Dendrobicæ*. Inflorescentia lateralis v. pseudoterminalis v. in scapo distincto aphylo. Pollinia 4, rarius 2, 1-seriata, parallela, inappendiculata.

Subtribus 5. *Eriæ*. Inflorescentia lateralis v. pseudoterminalis v. in scapo distincto aphylo. Pollinia 8, subæqualia, conferta, vix v. non appendiculata.

Subtribus 6. *Bleticæ*. Inflorescentia lateralis v. rarius terminalis. Pollinia 2-seriata (rarius 1-seriata), in quaque serie 4, parallela, omnia ascendentia, appendicula granulosa connexa.

Subtribus 7. *Cælogyneæ*. Inflorescentia terminalis. Pollinia 8 v. 4, subæqualia, conferta, visco v. appendicula parca connexa.

Subtribus 8. *Stenoglosseæ*. Inflorescentia terminalis. Pollinia 4, 6, v. 8, in locellis distinctis 1-2-seriata, libera v. visco tenui connexa.

Subtribus 9. *Lælicæ*. Inflorescentia sæpissime terminalis. Pollinia 1-2-seriata, in quaque serie 4, collateralia, parallela, compressa, appendicula granulosa connexa, inferiora ascendentia, superiora dum adsint descendentia.

Tribus 2. *VANDÆ*. Anthera 1, postica, opercularis, rostello incumbens v. applicita, loculis sub anthesi sæpissime confluentibus. Pollinia cerea, sæpissime 2 oblique v. transverse sulcata, v. 4 per paria sibimet applicita linea transversa separata, anthera dehiscente (sæpius jam in alabastro) rostelli processu (*glandulæ* v. *stipiti*) sigillatim v. per paria affixa, quocum *pollinarium* deciduum formant.

Subtribus 1. *Eulophicæ*. Folia pseudobulborum plicato-venosa. Scapi florentes aphylli v. foliati. Labellum calcaratum. *vel saccatum.*

Subtribus 2. *Cymbidicæ*. Folia pseudobulborum plicato-venosa. Scapi florentes aphylli v. foliati. Labellum ecalcaratum. Columna sæpissime apoda.

Subtribus 3. *Cyrtopodieæ*. Folia pseudobulborum plicato-venosa. Scapi florentes aphylli. Columna sæpissime in pedem producta.

Subtribus 4. *Stanhopieæ*. Folia pseudobulborum plicato-venosa. Scapi florentes aphylli. Columna sæpius apoda. Labellum carnosum.

Subtribus 5. *Maxillarieæ*. Folia non plicata. Scapi florentes aphylli v. pedunculi axillares. Columna in pedem producta.

Subtribus 6. *Oncidieæ*. Folia non plicata. Scapi florentes aphylli v. pedunculi axillares. Columna apoda.

Subtribus 7. *Sarcantheæ*. Caules ebulbosi, distichophylli, rarius aphylli, radicanter. Folia non plicata. Pedunculi laterales v. axillares.

Subtribus 8. *Notylieæ*. Rostellum terminale, erectum v. antrorsum inclinatum, postice sæpius concavum antheram fovens. Pollinarii stipes simplex v. duplex, angustus v. apice dilatatus, ab apice rostellii pendulus.

Tribus 3. NEOTTIEÆ. Anthera 1, postica, opercularis v. erecta persistensque, loculis distinctis parallelis. Pollinia granulosa pulverea v. sectilia. Caules ebulbosi.

Subtribus 1. *Vanilleæ*. Caules elati, sæpe ramosi, erecti v. alte scandentes. Racemi v. paniculæ terminales v. simul axillares. Anthera subopercularis, rostello brevi incumbens.

Subtribus 2. *Corymbieæ*. Caules elati interdum ramosi, foliis amplis. Racemi v. paniculæ terminales. Anthera erecta, rostello erecto parallela.

Subtribus 3. *Spirantheæ*. Caules simplices, erecti, foliis membranaceis rarius 0, rhizomate non tuberifero. Anthera erecta v. antrorsum inclinata, rostello longiusculo parallela.

Subtribus 4. *Diurideæ*. Caules simplices, erecti, aphylli, 1-foliati v. rarius paucifoliati, rhizomate varie tuberifero. Anthera erecta v. antrorsum inclinata, rostello brevi v. rarius longiusculo.

Subtribus 5. *Arethuseæ*. Caules simplices, erecti, aphylli 1-foliati v. rarissime paucifoliati, rhizomate sæpius varie tuberifero. Anthera opercularis, incumbens v. suberecta.

Subtribus 6. *Limodoreæ*. Caules simplices, erecti, foliati v. rarius aphylli, rhizomate non tuberifero. Anthera opercularis, incumbens v. suberecta.

Tribus 4. OPHRYDEÆ. Anthera 1, postica, erecta prona v. reflexa, loculis parallelis v. divergentibus distinctis clinandrio adnatis basi que sæpe in rostello continuis. Pollinia granulosa, in quoque loculo basi in caudiculam producta, caudiculis anthera dehiscente extremitate glandulæ a rostello solvendæ affixis.

Subtribus 1. *Serapiadeæ*. Anthera erecta. Polliniorum glandula in sacco a dorso rostellii elevato inclusæ.

Subtribus 2. *Habenarieæ*. Anthera erecta. Polliniorum glandulæ nudæ v. rarius rostellii lobis canaliculatis v. apice inflexis semiinclusa.

Subtribus 3. *Diseæ*. Anthera reclinata v. in dorso columnæ reflexa rarius suberecta. Stigma amplum pseudoterninale v. labello subadnatum.

Subtribus 4. *Corycieæ*. Sepalum posticum cum petalis sæpius in galeam

Subtribus 5. *Cyrtopodieæ*

cohærens. Labellum basi columnæ adnatum, ultra antheram varie productum v. appendiculatum.

Tribus 5. CYPRIPEDIÆ. Antheræ 2, ad latera rostellii v. styli sessiles v. stipitatæ, polline granuloso; anthera postica in antheridium polymorphum mutata, rarius perfecta v. omnino deficiens.

I now proceed to enter into a few explanatory details, taking the several tribes in the above order.

Tribe 1. EPIDENDRÆ.

This tribe is formed of the union of Lindley's Malaxidæ and Epidendræ, which, as already observed, he had distinguished by the absence or presence of a caudicle to the pollen-masses; but owing to the vagueness of the meaning attached to the term caudicle, and the real uncertainty in many cases as to the substance which often connects the pollen-masses, there are so many genera whose place in the one or the other tribe has been a matter of doubt, that Lindley himself had suggested the consolidation of the two, and their subdivision on other principles. This process he unfortunately never carried out in detail, although he gave some indication of it in his lists of genera in his 'Vegetable Kingdom.'

As a whole, Epidendræ are chiefly distinguished from Vandæ, the other great tribe of Orchidæ with waxy pollen-masses, by the distinctness of the two anther-cells, which are always parallel, or nearly so, and after discharging their pollen leave their margins or valves prominent within the anther-case, and by the removal of the pollen without carrying off any scale-gland or stipes formed by a layer or plate detached from the rostellum. This character is, in the great majority of genera, well marked and readily ascertained; but in some instances it requires very careful observation not to mistake it, and sometimes may really be rather uncertain. In coming to the following conclusions, I have been guided in the first instance by Darwin's clear exposition of the results of his careful study of the process of fertilization in a few leading genera; and I have followed them up by the observation of such species as I have been able to procure in a living state, and by the close examination of buds and open flowers in dried specimens of a great majority of the genera, and generally of many species of the larger genera. I am fully aware, however, that in this respect dried specimens often give but very unsatisfactory data. In those gathered wild the pollen is often already carried off by insects from flowers but just expanded; and it is so readily dis-

turbed by the process of pressing in drying, that its true form and relation to the rostellum is difficult to ascertain. It is very likely, therefore, that some of the statements here made may require considerable modification from further observation.

In the *Epidendrea* generally, before the anthers open, the pollen-masses are either quite distinct or are more or less connected in each cell, on the side next to the opening of the cell, by a substance formed of pollen-grains loosely connected by a tissue of highly elastic threads. This substance is exceedingly variable in appearance and amount in different genera. In those forming several of the first subtribes it is usually very small, or more frequently disappears altogether; in the latter tribes it is more often abundant and definite, and has been inappropriately termed caudicle, and taken as the distinctive character of *Epidendrea* as separated from *Malaxideæ*. In several genera of the *Ericæ* it is so variable in different species that the genera have been placed by some in *Malaxideæ*, by others in *Epidendrea*. In some *Bletieæ* it is very abundant, and almost envelops the waxy masses, or these are distinctly formed only at so late a stage that they have been overlooked, and the genera placed in *Arethuseæ* (now merged in *Neottieæ*). When the flower expands, the anther will sometimes fall away entire, with its pollen-masses; but, generally speaking, as soon as the anther-cells open, which often takes place in the bud, the exposed part of the pollen-masses (their points when they are pear-shaped or more or less acuminate or produced into short caudicles) becomes endued with a transparent, very viscid, almost liquid substance or viscum, by means of which the masses are connected together and adhere to any insect or other extraneous object with which they come in contact. This viscum has been shown by Darwin, Hooker, and others to exude in many cases, and perhaps in all, from the rostellum. It is sometimes so scanty as only to be detected by the fact of the pollen adhering to extraneous objects, and even to have failed entirely where the pollen-masses are seen loose about the flower in or out of the anther-case; in others so abundant as to completely envelop the rostellum and anther; sometimes, on opening a bud just ready to expand, I have found the whole inside a mass of viscum, from which it was difficult to extract the pollen. After the flower expands, if the pollen is not immediately carried away, this viscum will in some instances dry into a highly elastic thread, which may remain attached at one end to the rostellum

and at the other to the pollen-masses, and has given rise to the contradictory statements of careful observers as to whether such genera as *Tipularia*, *Oreorchis*, *Amblostoma*, *Seraphyllum*, *Collabium*, *Acrochæne*, *Chrysoglossum*, &c. have or have not the pollinarium of Vandææ. In some genera amongst Eriææ and Cœlogyneæ, and in a very marked manner in *Calanthe veratrifolia* and its allies, the viscum connecting the points of the acuminate or caudate pollen-masses is readily consolidated into a gland or disk lying on the rostellum, analogous, but not very similar, to that of Vandææ, whilst in all other respects the anther is entirely that of those subtribes of Epidendreæ, and not of Vandææ.

There are a few general characters in the vegetative organs or in inflorescence by which the majority of Epidendreæ may be distinguished from Vandææ; but they are not sufficiently constant to be taken into the tribal character, or are peculiar to some of the subtribes into the consideration of which I shall now enter.

Subtribe 1. PLEUROTHALLEÆ.—The chief character of this subtribe resides in the vegetative organs and inflorescence, the pollinary apparatus being generally that of Liparidææ, or the pollen-masses usually, but not always, smaller and fewer. The Pleurothalleæ are usually, but not always, small epiphytes. The flowering-stems, arising from the nodes of the rhizome or of a creeping caudex, are simple, not thickening into fleshy pseudo-bulbs; they bear, at the base or at intervals below the leaf, one, two, or more sheathing scales, and apparently terminate in a single leaf, either sessile or petiolate, but not forming any sheathing base; apparently also at the base or in the axil of this leaf is the inflorescence, sometimes a one-flowered peduncle, sometimes a raceme or a cluster of one- or several-flowered peduncles issuing from a sheath, which is sometimes very minute, sometimes long and spathe-like. In reality, however, this inflorescence is terminal, and the leaf lateral immediately under it. In the majority of the genera the stem is well developed under the leaf and inflorescence; but in *Masdevallia* the peduncles have the appearance of leafless scapes proceeding from the rhizome and mixed in the tuft with unifoliate stems; but in reality, as pointed out to me by Dr. Pfister, these apparently unifoliate stems are long petioles, bearing no sheathing scales, and the peduncles are always joined at the base to one of them within one of the scarious sheaths of the rhizome, both, in fact, normally terminating an exceedingly short stem. A nearly similar growth may be observed in a few

species of *Pleurothallis* itself, where the creeping caudex is stem-like and the peduncles and unifoliate stems or branches appear distinct, but are, in fact, joined together from the same node.

The *Pleurothalleæ* are all tropical American, and include, according to present estimates, above 600 species in ten genera, very fairly characterized, and, as to the great majority of species, readily distinguished from each other. *Pleurothallis* itself comprises about 350 species; and from amongst them it has been proposed by various authors to separate eight genera, mostly monotypic or nearly so, which, however, Lindley, in his latest monograph in the 'Folia Orchidaceæ,' has again reunited. He there distributes the species into ten series, which, for the 'Genera Plantarum,' I have somewhat modified and reduced to seven. *Stelis* (including *Dialissa*, Lindl.) with about 150 species, *Lepanthes* with 40, and the smaller genera *Physoziphon* and *Octomeria* remain intact. There has been some difficulty in the distinction between *Restrepia* and *Pleurothallis*, however marked it may be in some cases. Lindley was disposed to rely chiefly on the curious antenna-like form of the petals in some species; but this character is much too vague in others. Reichenbach would fix absolutely on the number of pollen-masses—two (one in each cell) in *Pleurothallis*, four in *Restrepia*; and, as far as is at present known, this may be the safest course to pursue; but the separation is not always natural, and perhaps not always quite definite. In *P. tubulosa*, for instance, which is clearly a *Pleurothallis*, Lindley found four pollen-masses, although in two specimens I examined I could only find two; and there are a large number of minute-flowered species in which the pollen has not been accurately observed. True *Restrepias* appear to have always single one-flowered peduncles; whilst true *Pleurothallises* have usually (but by no means always) a racemose or clustered inflorescence.

Distinct as the characters are, both vegetative and floral, which separate *Masdevallia* from *Pleurothallis*, there is one species which has apparently with equal right been published by Lindley himself in both genera—*Pleurothallis purpurea* or *Masdevallia fenestrata*. It has the stem elongated below the leaf and the sepals without spreading points, as in *Pleurothallis*; but the flowers are large, as in *Masdevallia*, under which genus it has been figured and has established itself in our collections. *Brachionidium*, Lindl., is a small genus evidently allied to *Masdevallia*, but requiring some

further investigation of its pollen, which our specimens do not enable us to carry out.

To the above eight genera already recognized as *Pleurothallæ*, I would add two somewhat anomalous ones—1. *Arpophyllum*, a Mexican and Central-American genus recently found also in Jamaica, comprising two or three closely allied species or varieties differing from the rest of the subtribe in their large size and long dense cylindrical flower-raceme. 2. *Meiracyllium*, Reichb. f., a little Mexican plant with small broad sessile leaves on very short stems at the nodes of the creeping rhizome, and bearing at their base a one- or two-flowered peduncle, entirely as in several species of *Pleurothallis*; but the pollinary apparatus is more that of *Eriæ*, and the rostellum is elongated and recurved over the column, in a manner very different from that of any other *Orchidea* hitherto observed.

Subtribe 2. *MICROSTYLÆ*.—The genus *Malaxis* of Swartz comprised a considerable number of terrestrial or bog-plants, with small flowers, chiefly from the temperate or subtropical regions of the northern hemisphere. Louis Claude Richard, perceiving that it included two very distinct groups, and considering the European, and especially Scandinavian, *M. paludosa* as the typical species of Swartz's genus, established the other group as a separate genus under the name of *Liparis*. Nuttall, apparently unaware of Richard's observations, and unacquainted with the *M. paludosa*, which is not American, regarded the *Liparis*-group as the true *Malaxis*, and proposed to separate the other one under the generic name of *Microstylis*. Lindley retained both Richard's and Nuttall's genera as distinct from *Malaxis*, which he limited to the single *M. paludosa*. Darwin has since shown the very close connexion of *Microstylis* with that species, which Nuttall indeed would probably have included in *Microstylis* if he had been acquainted with it. It appears, however, to have sufficient peculiarities to justify us in following Lindley and maintaining it as a monotypic genus, which with *Microstylis* (including *Dientia*) I should place in a subtribe separated from *Liparidæ* by the very remarkable position of the anther first distinctly explained by Darwin. Instead of being incumbent over or inclined towards the rostellum and falling off at or after the discharge of the pollen, as in the great mass of *Epidendrææ*, it is thrown back with the cells turned upwards, and, in most species at least, the anther-case either shrivels up or remains long persistent after the removal

of the pollen-masses. Whether this persistence is really constant in all the species remains to be proved; the flowers are generally so minute that their accurate observation in dried specimens is exceedingly difficult. Similar anthers have only been observed in *Sunipia*, an East-Indian pseudobulbous epiphyte with the habit nearly of some species of *Bulbophyllum*, but which, on account of this very important peculiarity in the anther, one cannot help associating with *Malaxis* and *Microstylis* in an artificial but distinct subtribe. For this subtribe I have taken the name of *Microstyleæ*, in preference to that of *Malawææ*, to prevent all confusion with Lindley's tribe Malaxidææ.

Subtribe 3. LIPARIDÆÆ.—The chief character of this subtribe rests in the terminal inflorescence without the terminal leaf of Pleurothallææ, and in the more or less distinctly 2-seriate pollen-masses (usually four), which in the normal genera are either quite free or with their points slightly connected after dehiscence by a very small quantity of viscum. The species are either terrestrial or more or less epiphytical, mostly natives of the temperate regions of the northern hemisphere or of the tropical Indo-Australian region, very few being found in tropical America. Of the eight genera we would include in the subtribe, the two principal ones (*Oberonia* and *Liparis*), which have each about 50 species. Reichenbach unites the former with *Malaxis*, from which it appears to me to differ as much in the structure of the flower as in habit. The operculate incumbent anther is quite that of *Liparis*, from which the generic distinction consists chiefly in the shortness of the column and in a peculiar distichous foliage with usually minute flowers in an almost spike-like dense inflorescence. It is also more tropical in its geographical distribution, and limited to the Indo-Australian and South Pacific regions. *Liparis* itself is somewhat variable in habit, often assuming that of the Asiatic species of *Microstylis*, from which the most remarkable deviations are Thouars's section *Distichis*, with its elegantly distichous bracts and flowers, and the Andine *L. ramosa*, Poepp., with decumbent, more or less branched, leafy stems. The generic name *Liparis* was altered by the elder Reichenbach into *Sturmia* and by Hoffmannsegg into *Alysia* as having been previously in use among entomologists; but that objection is now no longer held as tenable, and Richard's name is universally adopted. I should include in the genus not only *Empusa*, Lindl., already reduced to it by Reichenbach, but also that author's genus *Ephippianthus*

from Sachalin, and Blume's section *Platystylis* of *Malaxis*, raised by Lindley to the rank of a genus. Blume's *Gastroglottis*, only known from the short character in the 'Bijdragen,' may also possibly be a *Liparis*; but the *Gastroglottis montana*, published in the 'Xenia Orchidacea,' from the rude figure of Kuhl and Van Hasselt, is certainly a very different plant, probably allied to *Bulbophyllum*.

Dendrochilum, Blume, is placed by Lindley next to *Liparis*, to which the author's second section, including the *D. glumaceum* (figured, Bot. Mag. t. 4853), appears to be very nearly allied, differing chiefly in the long brachia to the column and the broad membranous clinandrium. Blume's second section, however, has in many respects the characters rather of the Dendrobieæ. I have therefore proposed to separate the first section generically under the name of *Platyclinis*, Blume himself having given no names to his sections. *Microstylis commelynifolia*, Zoll., from Java, a very distinct plant, with something of the habit of the above-mentioned *Liparis ramosa*, is certainly not a true *Microstylis*, but, as far as I could ascertain from the single minute flower I had to dissect, appears to be well referrible to *Platyclinis*.

The very distinct genera *Calypso* and *Aplectrum*, both monotypic, and *Corallorhiza* with about ten species, all northern and extratropical, are true Liparideæ. There are also three other small or monotypic northern extratropical genera which, on account of their evident affinity in many respects to *Corallorhiza*, I should refer to the same subtribe, notwithstanding some considerable differences in their pollinary arrangements. Two of them, *Tipularia* and *Oreorchis*, differ from each other chiefly in the labellum, spurred in the former and not in the latter; both of them have their pollen-masses more or less connected with the rostellum by a filiform stipes analogous to that of Vandææ; but there is no gland detachable from the rostellum, to which I often find the stipes remaining attached after the pollen-masses have been removed by insects or otherwise, and I sometimes find two only of the four pollen-masses adhering to the stipes, the other two remaining in the anther-case and falling off with it. The anther is described as two-celled in *Tipularia* and one-celled in *Oreorchis*, and so I have found them in the few flowers examined; apparently the dissepiment dries up early in the latter genus. This, however, requires further investigation in living specimens. Both genera have the remarkable reflexed capsule of *Corallorhiza*. The third anomalous genus of the

group, *Hexalectris*, Rafin., established on the *Bletia aphylla*, Nutt., has eight pollen-masses connected by a rather abundant granular appendage. This character has caused it to be referred to *Bletia*, and to be included by Blume in his admirable illustrations of Javan Orchideæ, where it is introduced for the purpose of comparison with the Old-World genus *Phaius*. *Hexalectris*, however, not only agrees much better with *Corallorhiza* in habit and general floral characters as well as in the capsule, but even the pollen-masses have the shape and position much more of *Liparideæ* than of *Bletieæ*.

Subtribe 4. DENDROBIEÆ.—In this subtribe there are either four collateral, more or less parallelly compressed, pollen-masses, without the points or short caudicles of *Erieæ* or the pollinary appendage of *Lælieæ*, or sometimes the four are reduced to two by the more or less complete union of the two of each cell. The inflorescence is normally lateral (the peduncles or leafless scapes either axillary or distinct from the leaf-bearing stems), and the flowers have almost always a prominent mentum, the column being more or less produced at the base. The form of the pollen-masses is somewhat modified in the smaller monotypic genera *Drymoda*, *Dendrochilum*, *Panisea*, and *Acrochæne*, and the lateral inflorescence is doubtful in a few species of *Dendrobium*; otherwise the subtribe is fairly distinct and easy to recognize. The plants are all (except, sometimes, *Chrysoglossum* and *Collabium*) epiphytical, and generally either pseudobulbous or with fleshy leaf-stems. They are all tropical and limited to the Indo-Australian or Mascarene regions, except *Bulbophyllum*, which is well represented in Africa and sparingly in tropical America.

The largest genus, *Dendrobium*, including at present nearly 200 species, is distinguished chiefly by the inflorescence, the peduncles proceeding always from the leaf-bearing stems or pseudobulbs, either lateral or apparently (perhaps sometimes really) terminal. When the inflorescence is lateral, in this genus as in some others of *Erieæ* or of some subtribes of *Vandææ*, it is often described as leaf-opposed; and so would it at first sight appear to be, for the leaf-sheaths are often very thin and closely cover the whole internode, the lamina starting from the top of the sheath close to the commencement of the leaf-sheath next above it, while the peduncle, really axillary in the base of the sheath, breaks its way through much below the lamina, and often but just above the opposite lamina of the lower leaf.

Blume proposed separating from *Dendrobium* no less than nine

subgenera or genera, which have, however, subsequently been reunited with it. Lindley divided it into ten sections, of which *Aporum* alone (including *Oxystophyllum* and *Macrostromum* of Blume, and *Schismoceras* of Presl) has any really distinctive characters, the others all pass much into each other; but, taking the most marked of them, I have for the 'Genera Plantarum' reduced Lindley's ten sections to seven, dividing *Stachyobium* into six and *Eudendrobium* into five subordinate series. Of these sections there are two only which call for any observations on the present occasion:—1. *Sarcopodium*, reduced to Lindley's § 1 of his genus of that name, was founded on *D. amplum*, Wall., and two or three allied East-Indian species with the peduncle to all appearance terminating short two-leaved stems, and bearing a single large flower. I have not had any opportunity of examining living specimens; but in the dried ones I can find nothing to show that the peduncle is not really terminal. Lindley's § 2 of *Sarcopodium*, with the leafless scapes proceeding from the rhizome, forms the section *Sectochilus* of *Bulbophyllum*. 2. *Cadetia* contains about a dozen mostly small species, with short stems or pseudobulbs proceeding from the creeping rhizome or caudex, and bearing each an apparently terminal single leaf with one or more axillary pedicels, almost as in *Pleurothallæ*, except that here, as in most species of the section *Stachyobium*, the inflorescence, although apparently terminal, is in fact in the axil of an almost terminal leaf.

Latourea, a single New-Guinea species, was described and figured by Blume chiefly from notes and a drawing made on the spot by Latour, and has not been reexamined by any other botanist. It is a handsome large-flowered plant, distinguished from *Dendrobium* only by the auricles at the base of the labellum encircling the column and united behind it. Further investigation may possibly induce its union with *Dendrobium*.

Bulbophyllum, Thou. (a name altered by some subsequent purists to *Bolbophyllum*), is a genus of about 80 species, differing from *Dendrobium* generally, but not always, by a more versatile or articulate labellum, and by prominent brachia or teeth to the column, and constantly by the inflorescence, the leafless scapes arising from the rhizome, either at the base of, or at a distance from, the leaf-bearing stems or pseudobulbs. The two pollen-masses of each cell are in several species unequal in size or more or less united into one, which has not to my knowledge been

observed in *Dendrobium*; and the genus has, as above mentioned, a much wider geographical range. As now circumscribed, it is somewhat polymorphous, and would include about a dozen small or monotypic ones, proposed at various times by Lindley, Reichenbach, or others, but since more or less abandoned by the authors themselves; and Reichenbach would now add three or four more which might yet be retained as separate with tolerably definite characters; whilst the seven series in which, for the 'Genera Plantarum,' I have proposed to distribute such species as I would regard as true *Bulbophylla*, being founded chiefly on inflorescence, often run too much one into the other to be considered as distinct sections.

Among the genera now united with *Bulbophyllum*, the following are the most important:—1. *Sestochilus*, Kuhl and Van Hasselt, being § 2 of Lindley's *Sarcopodium*, and including *B. Lobbii* and a few others with their scapes bearing a single large flower, and the teeth or brachia of the column less prominent than usual. 2. *Epicranthes*, Blume, a single species with two-flowered scapes, remarkable for several "antenna-like processes" on each side of the column. I have only seen two loose flowers in Parish's collection, which I could not dissect for examination; but these processes appeared to be lobed petals, and, if so, would not alone be sufficient for generic distinction. The differences in shape and size of the petals of Orchidæ are, generally speaking, of little more than specific value. 3. *Ione*, Lindl., was separated from *Bulbophyllum*, and transferred to Vandææ, as having two distinct oval cartilaginous glands connecting the pairs of the pollen-masses. I have not been able to examine the first three of Lindley's species; but in his *I. paleacea* (Bot. Mag. t. 6344), and in the several small or narrow-leaved species, I find the pollen-masses, when in the anther, quite those of *Bulbophyllum*, and sometimes remaining free, though often connected after dehiscence by an elastically extensive viscum, which will more or less dry up into one or two short laminæ, variously described or drawn by Lindley, Griffith, and others. *I. paleacea* has a peculiar habit; but the several narrow-leaved species are very difficult to distinguish from the common *B. reptans*. 4. *Didactyle*, Lindl., including *Xiphisusa*, Reichb. f., contained a few tropical-American species with a small tooth on each side of the column below the terminal brachia; but these teeth are more or less observable in several African species, and vary much from one species to another.

At the best the character connects species in other respects very dissimilar. 5. *Malachadenia*, Lindl., is a Brazilian species with the brachia of the column long and reflexed, and "a soft cubical gland to the pollen-masses," which is most probably a mass of viscum exuded from the rostellum. 6. *Bulbophyllaria*, Reichb. f., was originally founded on *Bulbophyllum bracteolatum*, Lindl. (in which I should include *Pleurothallis pachyrhyncha*, A. Rich., *Bulbophyllum sordidum*, Lindl., and probably also *Bulbophyllaria Erstedii*, Reichb. f.), a widely spread tropical-American species with the rhachis of the raceme thickened as in *B. clavatum*, Thou., and the ovary bearing at the top a little tooth or bract on each side of the perianth between the dorsal and lateral sepals. *Didactyle meridensis*, Lindl. (including *D. exalata*, Lindl.), is a closely allied species with the rhachis scarcely thickened, and the teeth or bracteoles very small, though certainly present. Reichenbach has since added to the supposed genus the *Bulbophyllum bisetum*, Lindl. (*B. cirrhopetaloides*, Griff.), an East-Indian species with a totally different habit, the rhachis not thickened, but the teeth or bracteoles of the ovary linear-setaceous and nearly as long as the perianth, and the *B. clavatum*, Thou., from Madagascar, with the thickened rhachis, but no teeth to the ovary, at least in our specimens. Whatever be the homology of these curious appendages to the ovary, it is evident that they are here of specific value only, and have not the more important character of those which distinguish *Epistephium* from *Sobralia*. 7. *Odontostylis*, v. Breda, and 8. *Oxysepalum*, Wight, must be considered rather as a series of species than as sections, distinguished by peculiarities of habit more or less conspicuous in about twenty species of the former and six of the latter, all Asiatic, unless the Brazilian *B. Regnelii*, Reichb. f., be referrible to *Odontostylis*. 9. *Cochlia*, Blume, only known from the short characters in the 'Bijdragen,' may probably be a *Bulbophyllum* of that umbellate or capitate series which in some measure connects the genus with *Cirrhopetalum*, but has the more regular sepals of the *Bulbophylla*. 10. *Lyræa*, Lindl., was founded on A. Richard's figure of *B. prismaticum*, Thou., which is evidently faulty; and Blume has restored the plant to *Bulbophyllum*.

Cirrhopetalum, Lindl. (*Zygoglossum*, Reinw.), consists of about 30 species from the Indo-Australian and Mascarene regions, closely connected with *Bulbophyllum*, and united with it by Blume and sometimes by Reichenbach, who, however, retains it as a

genus in some of his horticultural articles. The umbellate inflorescence, accompanied by the elongated parallel lateral sepals, give the great majority of species so peculiar an aspect that the group may be more conveniently considered as a genus than as a section, notwithstanding the *C. Wallichii*, Lindl. (*C. refractum*, Zoll.), in which the umbel is elongated into a raceme, but with the characteristic lateral sepals very conspicuous, and the few umbellate species retained in *Bulbophyllum* as having the sepals equal and regular. The only really intermediate species I am acquainted with is the Australian *C.* or *B. Elisæ*, which F. Mueller published under either generic name, giving, however, the preference to *Cirrhopetalum*, to which, after all, it may be more nearly allied than to *Bulbophyllum*, under which I entered it in the 'Flora Australiensis.' *Bulbophyllopsis*, Reichb. f., was a genus proposed for the *Cirrhopetalum maculosum*, Lindl. (*C. bootanense*, Griff.), but since given up by the author as being in every respect a true *Cirrhopetalum*.

Megaclinium, Lindl., about nine African species with a very exceptional inflorescence, and *Trias*, Lindl., three East-Indian species with a distinct habit and a marked appendage to the anthers, although united by Reichenbach with *Bulbophyllum*, appear to be sufficiently constant in habit and character to be retained as genera. *Osyricera*, Blume, a single Javan species only known to me from the author's figure and description, is probably also very near *Bulbophyllum*, but distinguished by a curious appendage to the anther and other minor characters.

Drymoda, Lindl., is a curious little Malayan plant with the general aspect of *Eria extinctoria*; but the filiform scape is attached under the base of the orbicular pseudobulb as in *Bulbophyllum*. The lateral sepals are attached to the end of the long basal projection of the column as in *Monomeria*, and the pollen-masses are rather those of *Bulbophyllum* than of *Eria*, but with a curious globular appendage, which, according to Griffith's drawing, is of the colour of the pollen, but exerted from the anther-cells. The only flower I could examine was in too imperfect a state to ascertain the real nature of this appendage.

Monomeria, Lindl., was founded on a Nepal plant evidently very closely allied to some of the larger species of *Bulbophyllum*, but with the lateral sepals attached to the end of the long basal projection of the column. Lindley described and sketched out in his herbarium the pollen-masses as parallel and laterally com-

pressed, as in *Bulbophyllum*, but almost connate into a globular mass. In Parish's Moulmeyn collection is a specimen very closely resembling the Nepal species; but the pollen, according to Parish's drawing, though similar in shape, has become attached to a stipes with a gland precisely as in Vandææ. Mr. Parish's analytical drawings of Moulmeyn Orchids are so exceedingly accurate and so generally taken from living specimens, that Reichenbach, in describing the collection for the Linnean Transactions (vol. xxx.), accepted his representation of the pollinarium of *Monomeria* without hesitation, and had it copied in the plate in which he figured the plant as a genus of Vandææ, very unlike any one yet known in that tribe. Unfortunately neither Parish's nor Lindley's specimens afford the means of verifying the point; but in two flowers ready to open, taken from a specimen I had from Wallich, I find the pollen exactly as drawn by Lindley without the stipes and gland. I cannot help thinking, therefore, that the pollen figured by Parish had become accidentally attached to some extraneous body mistaken for the stipes, a conjecture somewhat confirmed by the very exceptional manner in which the pollen appears attached to the supposed stipes, which, moreover, does not correspond in shape with that of the rostellum, from which it would have been detached.

Dendrochilum, Blume, reduced to his first section, certainly in some measure connects Liparidææ (to which I have above referred Blume's second section) with the Dendrobicææ allied to *Bulbophyllum*; for it has the small flowers in a slender raceme of the former subtribe, with flowering leafless scapes issuing from the stem-like caudex distinct from the unifoliate pseudobulbs, and the labellum articulate on the basal projection of the column as in *Bulbophyllum*. The pollen-masses are in some measure intermediate between those of the two subtribes, but appear to be rather nearer to those of *Bulbophyllum* than of *Liparis*.

Panisea, Lindl., reduced to the two original species, *P. parviflora* and *P. reflexa*, with the habit of *Bulbophyllum reptans*, appears also in its flowers to be much nearer to that genus than to *Cælogyne*, of which Lindley had at first made it a section. But *P. apiculata* and *P. uniflora*, afterwards added by Lindley, have not the peculiar labellum of *Panisea*, and appear in all respects to be true species of *Cælogyne*, to which, indeed, Reichenbach has already transferred the *P. apiculata*. I cannot, however, concur with him in referring *Cælogyne bilamellata*, Lindl.,

to *Panisea*. The labellum is shortly saccate at the base, as in *C. prolifera*, Lindl., not flexuose, as Reichenbach may have been led to conclude from the sketch in Herb. Lindl., taken from an accidentally injured flower.

Acrochane, Lindl., a single species from Sikkim, has the habit of some of the larger species of *Bulbophyllum*; but the anther is one-celled at the time of dehiscence, with two globular pollen-masses, as in Vandææ. These pollen-masses are, however, connected by a bipartite lamina, apparently a pollinary appendage, almost as in Bletieæ, and not a production of the rostellum. The genus thus shows some affinity to each of the three groups, but rather more to Dendrobieæ than to either of the others.

Chrysoglossum, Blume (including *Diglyphosa*, Blume), four species, and the closely allied *Collabium*, Blume, one species, all from the Malayan archipelago or the eastern provinces of India, have a peculiar habit connected with that of the Dendrobieæ. The anther-cells are very distinct and parallel as in that tribe, and there is no stipes or gland to the two pollen-masses, although in their globular shape they much resemble those of Vandææ.

Subtribe 5. ERIÆ.—The inflorescence is lateral, as in Dendrobieæ (axillary, pseudoterminal, or on independent leafless scapes), but the pollen-masses, always eight in number, four in each cell, have their points or short caudicles more or less connected by a pollinary appendage or viscum, varying in amount, often so scanty that the genera have usually been placed in Lindley's tribe Malaxideæ; whilst in many cases it is so conspicuous that Blume, Reichenbach, and others have transferred them to Epidendrea. With the exception of the small American genus *Cælia* and a single African *Pachystoma*, they are all limited to the Indo-Australian and South-Pacific regions.

The principal genus *Eria*, Lindl. (*Dendrobium*, Blume; *Octomeria*, Don, not of R. Br.), includes about 80 species, more varied in aspect than most large genera of Orchids, and yet very generally admitted with little diversity of opinion as to the limits to be assigned to it, except as to individual species which have occasionally been proposed as distinct genera, but subsequently restored to *Eria* by Lindley, Blume, or Reichenbach. For our 'Genera Plantarum' I have adopted the ten following sections, almost entirely the same as those characterized by Lindley and others either as sections or as genera:—1. *Porpax*, Lindl., including *Ageianthus* and *Lichenora*, Wight, dwarf plants with the

flowers, often rather large, almost sessile amongst the pseudobulbs. Reichenbach has referred Lindley's two original species to *Cryptochilus*, on account of the sepals being united almost to the top; but the sepals are more or less united in *E. lichenora*, Lindl., *E. ustulata*, Reichb. f., and *E. Parishii*, Lindl., which Reichenbach retains in *Eria*, and the other floral characters and inflorescence are completely at variance with those of *Cryptochilus*. 2. *Conchidium*, Griff., dwarf plants with slender one-flowered peduncles, which often appear terminal on a leafless pseudobulb, but are really in the axil of a leaf which has disappeared before the time of flowering. 3. *Bryobium*, Lindl., including *Alvisia*, Lindl., dwarf plants with the habit of *Conchidium*, except that the peduncle bears a raceme of small flowers. 4. *Mycaranthus*, Blume, with longer, scarcely pseudobulbous bifoliate stems, and one or two peduncles from the upper nodes bearing a dense secund raceme of numerous small flowers. 5. *Eriura*, Lindl., with taller several-leaved stems, and several racemes of small flowers. 6. *Hymeneria*, Lindl., and 7. *Urostachya*, Lindl., the stems leafy, with loose racemes of rather larger glabrous flowers, pseudoterminal in *Hymeneria*, lateral in *Urostachya*. 8. *Dendrolirium*, Lindl., the flowers usually woolly, or, if glabrous, rather large, on leafless scapes arising from the base or near the base of the leaf-bearing pseudobulbs. This is a rather polymorphous section not very well defined, as it includes:—*E. rosea* and its allies (*Xiphosium*, Griff.) and *E. acridostachya*, Reichb. f., in which the upper sheaths of the scape bear sometimes a leafy lamina and the rather large flowers are glabrous; *E. stellata*, Lindl., and its allies (*Octomeria vaginata*, v. Breda, &c.), with a long loose raceme; and *E. barbata*, Reichb. f., formerly referred by Lindley to *Tainia*, differing from all other *Erias* in its long, loose, branching raceme. *Dendrolirion*, Blume, appears to have been originally intended for the whole genus *Eria*. 9. *Trichotosia*, Blume, robust hispid leafy stems, with short axillary racemes; and 10. *Cylindrolobus*, Blume, including *Ceratium*, Blume, with glabrous leafy stems and very short lateral peduncles bearing two or three rather large flowers on long pedicels. Lindley's section *Trichosma*, is here omitted, as being more appropriately considered a distinct genus of Cœlogyneæ.

Cœlia, Lindl., is a genus of four or five species from Central America and the West Indies, scarcely differing from *Eria* except

in stature, and, as far as known, in the broad wings to the capsule.

Phreatia, Lindl., including *Plexaure*, Endl., contains about ten species from the Indo-Australian and South-Pacific regions, with the foliage of *Oberonia*, and apparently similar small racemose flowers; but the lateral peduncles and pollinary apparatus are entirely those of *Eriæ*; and Reichenbach unites the genus with *Eria* itself.

Pachystoma, Blume (*Apturia*, Lindl.), as originally constituted, was a very natural group of about eight East-Indian or Malayan species, all leafless, with much of the aspect of the flowering-stems of *Pogonia*, but with the characters of *Eriæ*. Blume, and even Lindley himself, have since added to it as a section Lindley's *Ipsea*, which, besides the flowering scapes, produces pseudobulbs with one or two leaves, and the flowers are few, large, with characters slightly different from those of the typical *Pachystoma*; and the section might well have been kept up as a distinct genus, especially since it has been confirmed by the addition of a tropical-African species, *P. Thomsonianum*, Reichb. f.

Spathoglottis, Blume, as limited by Lindley, comprises about ten species from the Indo-Australian and South-Pacific regions, separable into two series, distinguished, however, more by stature and size and number of leaves and flowers than by any definite characters; and I cannot concur with Reichenbach in transferring one of these series to *Pachystoma*, from which it appears to me to differ as much in the shape of the flowers as in habit. *Paxtonia*, Lindl., from the Philippine Islands, precisely resembles the larger species of *Spathoglottis*, excepting in its perfectly regular perianth, the labellum being similar to the petals. Lindley has suggested that it might be a peloria-state of a true *Spathoglottis*, to which Reichenbach has consequently referred it with doubt in Walpers' 'Annales.' The supposition, however, requires further confirmation.

Subtribe 6. BLETIÆ.—This subtribe of about 50 species is a fairly natural one, and, making allowance for a very few exceptional species, it is well defined. The leaves of the pseudobulbs are large or long, with prominent veins, often plicate; the inflorescence, with the exception of two or three species of *Phaius* and *Bletia*, on separate leafless scapes; the pollen-masses, usually 8, are, like those of *Læliæ*, laterally compressed and parallel

in two series; but the pollinary appendage is very abundant and the masses of both series are adnate to it upwards or nearly their whole length, the smaller series is deficient only in *Anthogonium*. The genera mostly belong to the Indo-Australian region; but *Chysis* and *Bletia* itself are tropical American with one Chinese and Japanese species of the latter, and one species of *Phaius* has been found in tropical Africa.

The three genera *Acanthephippium*, *Phaius*, and *Bletia* have been admirably worked out and illustrated in Blume's great work on Javan Orchids, and my own observations lead in every respect to confirm his conclusions, except in regard to the North-American *Bletia aphylla*, Nutt., which I have above mentioned as an anomalous Liparidea allied to *Corallorhiza* under Rafinesque's name *Hexalectris*. The Chinese and Japanese *Bletia hyacinthina* and the Indian and Malayan *Phaius albus* and its allies, differ from the rest of the subtribe in their racemes terminating leafy stems; and Reichenbach has proposed to separate them generically, the former under the name of *Bletilla*, the latter under that of *Thunia*, and to transfer them to Lindley's tribe of Arethuseæ on the supposition that the pollen was entirely granular. But Blume has well shown that this is a mistake. In the early stage the pollen-masses are quite continuous with, and scarcely distinguished from, the mass of pollinary matter forming the appendage, and in withered flowers a considerable quantity of granular pollen will sometimes remain in or about the anther-case; but about the time of dehiscence I have seen the eight pollen-masses quite distinct, and as waxy as in other Bletieæ, in dried specimens of *Bletia hyacinthina* and *Phaius albus* and in living specimens of *Phaius Bensoniæ* (Bot. Mag. t. 5694). I therefore follow Blume in reuniting them with *Bletia* and *Phaius* respectively, dividing *Bletia* into two sections, *Eubletia* and *Bletilla*, and *Phaius* into four, *Euphaius*, *Gastrorchis* (including *Pesomeria*, Lindl.), *Thunia*, and *Limatodes*. I should exclude, however, from the latter the *L. gracilis* and *L. rosea*, Lindl., which are both referrible rather to *Calanthe*.

Chysis, Lindl., is a tropical-American genus of half a dozen species, in which the granular mass or pollinary appendage is remarkably large, sometimes almost enclosing the pollen-masses. *Nephelephyllum*, Blume (*Cytheris*, Lindl.), contains four species from the Indo-Malayan region, and is well illustrated by Blume.

Tainia, Blume (*Ania*, Lindl.), six or seven Indo-Malayan species, appears to me to be a well-defined genus, connecting in some measure *Eriæ* with *Bletieæ*, but much nearer to the latter, both in habit and in pollen. Reichenbach, however, refers *Ania angustifolia*, Lindl., to *Pachystoma*, and the other species to *Eria* itself, upon grounds which I have failed to discover. The original *T. speciosa*, Blume, differs from all the other species in the long setiform tails to the sepals and petals.

Anthogonium, Lindl., a single Himalayan and Burmese species, is remarkable in the subtribe for the deficiency of the upper smaller series of pollen-masses; but the habit, inflorescence, and some other characters, besides the stature, prevent the transferring it to *Lælieæ*.

Subtribe 7. CÆLOGYNEÆ.—The genera collected in this subtribe are perhaps not very well connected with each other, and the character of the subtribe is not so definite as might be wished, yet none of the genera appear to be more nearly related to any one of any other subtribe. The pollen-masses, four or eight, are usually clustered, tapering into points or short caudicles, as in *Liparidæ* and *Eriæ*, but are often more compressed than in those subtribes, and sometimes as much so as in *Lælieæ*; they are often connected by a more or less distinct granular appendage, or more frequently after dehiscence by more or less of viscum, sometimes even consolidated into a gland. The inflorescence, always terminating the leaf-bearing stem, separates them well from *Eriæ*; and although in a few species the flower appears at the end of a stiff, leafless stem, or pseudobulb, it is because the leaves are produced at a later season, and can only be seen when the specimen is already in ripe fruit, or even still more advanced. The distinction from *Liparidæ* is not so easily expressed in words, although each of the four or five groups in which the subtribe may be divided is marked by some special character in foliage, inflorescence, or structure which does not occur in *Liparidæ*; and in Lindley's arrangement the genera were mostly placed in *Epidendrææ*, or in *Vandææ*, not in *Malaxidææ*. They are all natives of the Indo-Australian and South-Pacific region, with the exception of *Calanthe*, which is very sparingly represented in Africa and tropical America, and *Elleanthus*, which is exclusively American.

As a first group we have two genera with small flowers in a pedunculate, more or less branched panicle, both of them with four

pollen-masses. In *Josepha*, Wight, two species from the Indian Peninsula and Ceylon, the flowers are racemose along the more or less elongated branches of the panicle. In *Earina*, Lindl., two New-Zealand species, and four more or less marked varieties of a third, if not all distinct species, from the South-Pacific islands, the flowers are crowded along the short branches, sometimes almost reduced to sessile clusters.

The next group includes three genera with small flowers collected in terminal sessile heads, all three from the Indo-Malayan and South-Pacific region:—*Glomera*, Blume, two species with rather loose heads, terminating leafy stems, the flower protruding beyond the bracts, and only four pollen-masses. *Agrostophyllum*, Blume, about five species, the dense sessile heads terminating the leafy stems as in *Glomera*, but the flowers almost concealed by the imbricated bracts and the pollen-masses eight, with some other differences in the structure of the flower. *A. megalurus*, Reichb. f., from the Samoa Islands is, however, unknown to me; but from the long spiciform inflorescence and other characters given (from an imperfect specimen) it can scarcely be a congener. *Ceratostylis*, Blume, has the eight pollen-masses of *Agrostophyllum*; but the stems having only a single apparently terminal leaf continuous with them, the little head of flowers appears lateral.

The third group comprises three genera from the Indo-Malayan region with spicate or racemose flowers and eight pollen-masses, the lateral sepals more or less connate at the base, with the protruding base of the column forming a mentum or protuberance, as in several of the preceding genera:—*Callostylis*, a single Javan species, only known from Blume's 'Bijdragen'; *Cryptochilus*, Lindl., two Himalayan species remarkable for the sepals connate into a tubular perianth; *Trichosma*, Lindl., a single Khasiya species, which Lindley had at first described as a *Cœlogyne*, but which he later followed Reichenbach in referring as a section to *Eria*, but the habit, the strictly terminal raceme, and the laterally compressed pollen-masses are those of *Cœlogyneæ* rather than of *Eriæ*.

The fourth and typical group of *Cœlogyneæ* comprises six genera with spicate racemose or solitary flowers, and no basal projection to the column, of which three (*Cœlogyne*, *Otochilus*, and *Pholidota*) are epiphytical and usually pseudobulbous, with four pollen-masses, and three (*Calanthe*, *Arundina*, and *Elleanthus*) are

usually tall terrestrial herbs, with plicate leaves, no pseudobulbs and eight pollen-masses.

Cœlogyne, as defined by Lindley in some of his latest works, is a natural genus of about 50 species from the Indo-Malayan region. His three sections, *Neogyne*, *Pleione*, and *Cœlogyne* proper, have been regarded by some as distinct genera; and of these *Pleione*, Don, is kept up by such in most horticultural publications, for, as far as is shown by the species in cultivation, it is easily recognized by its handsome flowers solitary on the stems or pseudobulbs, which, as in other sections of *Cœlogyne*, are sometimes leafless at the time of flowering. But there are a few species of *Cœlogyne* proper in which the raceme is reduced to two flowers or to a single one, and all other characters assigned break down in one or more species of one or the other group. *Otochilus*, Lindl. (including *Tetrapeltis*, Wall.), containing three or four species, is reduced by Reichenbach to a section of *Otochilus*, to which it is certainly closely allied; but the marked difference in vegetation, which alone might not have been a sufficient generic distinction, is here accompanied by the small racemose flowers and differences in the labellum which may justify the separation. *Pholidota*, Lindl., about 20 species from the same region, is also reduced by Reichenbach to a section of *Cœlogyne*; but here, besides the small flowers and the inflorescence, we have a well-marked character in the shortness of the column. The genus is divisible into two sections by the vegetative characters which separate *Otochilus* from *Cœlogyne*, but by no other. In the one the new shoots proceed from the rhizome at the base of the previous year's pseudobulb, as in *Cœlogyne*; in the other, as in *Otochilus*, the new shoots are formed near the apex of the previous year's growth, giving the older stems a jointed appearance, as if formed by a succession of pseudobulbs. In Blume's 'Bijdragen,' *Pholidota* and *Cœlogyne* formed sections of his genus *Chelonanthera*.

Calanthe, Lindl., including *Centrosia*, Thou., *Amblyglottis*, Blume, *Styloglossum*, v. Breda, *Ghiesbreghtia*, A. Rich., and *Preptanthe*, Reichb. f., is a genus of about 40 species, chiefly from the Indo-Malayan region, but extending also to the South-Pacific islands and to tropical and South-eastern Africa, and represented by two or three species from Central America and the West Indies. It has usually been placed in *Vandææ*, because the viscum which after dehiscence connects the points or caudicles

of the pollen-masses hardens into a disk-like gland contiguous to the rostellum; but the perfectly 2-celled anther and the eight distinct pollen-masses tapering into points or caudicles are totally unlike what is observed in *Vandææ*; and although the viscum forming the gland may be, as in many of the preceding genera, an exudation of the rostellum, it does not appear to me to be a scale or lamina detaching itself from the upper surface of the rostellum, as in true *Vandææ*, although it might, perhaps, be compared to the gland of *Ophrydææ*. *Calanthe* therefore appears to me to be referrible, as well in character as in habit, to *Cœlogynææ* and not to *Vandææ*. The species have been distributed by Lindley into two series, according as the spur of the labellum is elongated, or short or quite obsolete, but the distinction is vague and not confirmed by habit. Some species, however, such as *C. densiflora*, Lindl., and *C. curculigoides*, Lindl., are well marked by their dense racemes and scarcely spreading perianths; and, again, three species, *C. gracilis*, Lindl., without any spur, *C. brevicornis*, Lindl., with a short spur, and *C. densiflora*, Lindl., with a long one, have the column exceptionally produced above the tube which it forms by its connection with the labellum.

The facility with which *Limatodes rosea*, Lindl., can be made to hybridize with *Calanthe vestita* has been given as an instance of ready hybridization between two distinct genera; but the fact appears to be that *L. rosea* itself has all the characters of *Calanthe* and not of *Cœlogyne*, and is indeed a species very nearly allied in every respect to *C. vestita*.

Arundina, Blume, is a well-characterized Indo-Malayan genus of about five species, and I quite agree with Reichenbach in uniting with it Lindley's *Dilochia*. This genus was distinguished by the lateral lobes of the clinandrium bearing perfect anthers; but Blume has shown that this anomaly is not constant, and it has been occasionally observed as an accidental anomaly in a few flowers of two or three very different genera of *Orchidææ*.

Elleanthus, Presl (*Evelyna*, Poepp.), is a natural and well-characterized tropical-American genus of nearly 50 species, mostly with short dense terminal heads or spikes with closely imbricate bracts, but one or two species, with a longer loose inflorescence, assume almost the habit of *Neuwiedia*.

Subtribe 8. STENOGLOSSEÆ.—The genera which I have collected = *Lasia* in this subtribe are mostly small-flowered epiphytes, which have been generally classed either as sections of *Epidendrum* or as

genera nearly allied to it. Like *Lælieæ*, they are all American, they all have a terminal inflorescence, and many of them have, as in *Epidendrum*, the labellum united with the column at the base; but the pollinary arrangement is so different that some have been transferred to other groups, even to *Vandææ*. The pollen-masses (4, 6, or 8), are usually ovoid or globular, not at all or scarcely compressed, and distinctly separated in the anther by spurious dissepiments, dividing each cell into two, three, or four cellules or compartments; they are free, or nearly so, within the anther, though often after dehiscence connected by a small quantity of viscum, which sometimes extends into one or two elastic threads, connecting them also with the rostellum. The pollinary appendage so characteristic of *Lælieæ* is entirely wanting, or only very slight traces of it may be observed in a very few species. The genera I should propose to include are ten:—1. *Lanium*, Lindl. (as a section of *Epidendrum*), two species differing from all the others in the four pollen-masses, not collateral, as in the next seven genera, but two in each cell, superposed and separated by a transverse or somewhat oblique, not longitudinal, dissepiment, this genus closely connecting the subtribe with that of *Liparidææ*. 2. *Amblostoma*, Scheidw., founded originally on *Epidendrum tridactylum*, Lindl., and transferred by Scheidweiler to *Vandææ* on account of the double thread-like elastic viscum which often connects the pollen-masses with the rostellum. It now includes also *A. micranthum* (*Epidendrum*, Hook.), and *A. densum*, Reichb. f.; in all these species the four pollen-masses are collateral in as many apparently equal cells in an almost reniform anther. 3. *Seraphyta*, Fisch. and Mey. (whose character, though repeated in the 3rd supplement to Endlicher's 'Genera,' was overlooked by Lindley), established on the *Epidendrum diffusum*, Lindl., which only differs from *Amblostoma* in the form of the labellum and of the anther-case. 4. *Diothonea*, Lindl., including *Gastropodium*, Lindl., and *Hemiscleria*, Lindl., four species with the anther of *Amblostoma*, but differing in habit, inflorescence, and some other characters. 5. *Stenoglossum*, H. B. & K., a single species only, very slightly differing from *Diothonea*. 6. *Homidium*, Lindl. (as a section of *Epidendrum*), about seven species, with the same almost reniform anthers, all dwarf plants with a very peculiar habit. 7. *Hexisia*, Lindl., including *Euothonea*, Reichb. f., three or four species; 8. *Scaphyglottis*, Poepp. and Endl. (*Cladobium*, Lindl.), about eight species; and 9. *Hexadesmia*, Brongn., four or

five species; all three genera remarkable for their vegetative character and peculiar habit, arising from each year's shoot or narrow pseudobulb proceeding from near the end of that of the preceding year. In *Hexisia* the column and labellum are united at the base, as in the preceding genera, and there are four collateral pollen-masses; in *Scaphyglottis* the pollen-masses are likewise four, but the labellum is free from the column; and in *Hexadesmia* the labellum is again free, but in the anthers, besides the four collateral pollen-masses, there is a second upper series of two, one in each cell. To the above nine genera I would add as a new one, under the name of *Octadesmia*, the *Octomeria serratifolia*, Hook. Bot. Mag. t. 2823, transferred by Grisebach to *Tetramicra*, and by Reichenbach to *Bletia*, from all of which genera it appears to me to be much further removed than from *Hexadesmia*. The habit is that of some species of *Epidendrum*; the anthers are those of *Hexadesmia*, except that both series of pollen-masses are complete in number, eight in all.

Subtribe 9. LÆLIÆ.—The chief characters of the Læliæ, or Epidendræ proper, reside in the pollen-masses, four in one series or eight in two series, those of each series laterally compressed, collateral and parallel, connected by a pollinary appendage in the form of two linear laminæ, often uniting into one, and ascending from the base of the lower or single series along their outer edge; the upper series, when present, descending from the upper end of the lamina, and often smaller than the lower series, never ascending like the lower series, as occurs in Bleticæ. The inflorescence is almost always terminal. The genera are all exclusively American, tropical or subtropical, and the habit usually, if not always, epiphytical and frequently pseudobulbous.

I have included sixteen genera in the subtribe, for which I have taken Lindley's name, as having been applied by him to a group almost identical; but of these sixteen, two are somewhat doubtful. *Atamania*, Llave and Lex., a single Mexican species, is only known to me from a specimen of Hartweg's in Lindley's herbarium, which he had referred to Llave and Lexarsa's genus, but which scarcely corresponds with their character. Lindley associated it with *Epidendrum*, probably on account of the form of the perianth; and from the original character we should suppose the inflorescence to be terminal; but in Hartweg's specimen the short raceme is on a leafless scape from the base of the bifoliate pseudobulb, and the characteristic pollinary appendage of Læliæ

appears to be almost or wholly deficient, which would bring the plant nearer to the Dendrobicæ, where, however, the *Epidendrum*-like union of the labellum with the column is as yet unknown. The place of the genus can only be determined when further specimens shall have come to hand. *Pleuranthium*, Lindl. (referred by him as a section to *Epidendrum*), five or six species, has the characters of *Epidendrum* or almost of *Ponera*, except that the short racemes or clusters of small flowers are sessile, or nearly so, in the axils of distichous leaves, an inflorescence totally at variance with that of the rest of the subtribe.

The normal genera of the subtribe form three series, the first eight of them having four pollen-masses only, without any trace of the upper series, three (*Læliopsis*, *Tetramicra*, and *Brassavola*) in which the upper series is present, but much smaller than the lower, and three (*Lælia*, *Schomburgkia*, and *Sophronitis*) in which the two series of four each are equal or nearly so. But these distinctions are artificial and not always absolute, although great importance has sometimes been attached to them.

Diacrium, Lindl. (referred by him as a section to *Epidendrum*), founded on *Epidendrum bicornutum*, Lindl., contains four described species or marked varieties, in which the peculiar bicornute labellum, neither adnate to nor parallel with the column, gives the flower a very different aspect from that of the true species of *Epidendrum*, and cannot be included in them without doing violence to the generic character.

BOSCH!

Isochilus, Br., limited to the original *I. linearis* and three or four species recently added to it, has a very peculiar habit, a free labellum, and a few other distinctive characters of minor importance. The other species enumerated in Lindley's Genera and Species of Orchidæ have since proved to belong to various other genera. Reichenbach found in *I. linearis* six pollen-masses, each cell of the anther being divided into three compartments. This must have been in some abnormal individual. I have repeatedly examined both fresh and dried specimens, and have always found the normal four in a single series.

Ponera, Lindl., including *Tetragamestus*, Reichb. f., altogether four species, is specially distinguished from *Epidendrum* by the flowers, usually small, showing a prominent mentum, the labellum being adnate at the base to a basal projection of the column. The inflorescence is also occasionally abnormal; the short, dense racemes are, indeed, terminal on the year's shoot, but besides these

there appear on the old stems lateral clusters which must probably be considered as leafless flowering branches. In *Tetragamestum modestum*, Reichb. f., which has all the characters of *Ponera*, the year's shoot proceeds from the end of that of the previous year, making the persistent terminal cluster of flowers appear lateral, as in *Scaphyglottis*; whilst in other species the new shoot appears as if in continuation of the old one, without any persistent remains of the raceme. Reichenbach unites *Scaphyglottis*, Poepp., with *Ponera*, in which I cannot concur, the pollinary apparatus being quite at variance with that of *Lælieæ*. *Ponera adendrobium*, Reichb. f., with really axillary inflorescence, appears to me to be a species of *Pleuranthium*; but the flowers in our specimen are too much withered to admit of positive determination.

Pinelia, Lindl., is a dwarf Brazilian plant, only known from the drawing and memorandum of Pinel in herb. Lindl. Reichenbach once referred it to *Restrepia*; but the pseudobulbs, the labellum adnate to the column, and the pollinary apparatus are quite at variance with the characters of that genus, and seem to show a close affinity to *Sophronitis*, differing chiefly in the pollen-masses, four instead of eight.

Hartwegia, Lindl., is a single Central-American species, with the mentum of *Ponera*, and the habit and adnate labellum of the *Amphiglottis* group of *Epidendrum*.

Epidendrum itself, as now limited, is still an enormous genus, of which nearly 400 species, good or bad, have been described. It was well worked up by Lindley in his 'Folia Orchidacea;' but since then, owing chiefly to the exertions of horticultural collectors, a considerable number of new species have been added, and more abundant materials supplied for judging of the old ones. Lindley divided the genus into twelve sections; but from these must be deducted four small ones, *Diacrium*, *Hormidium*, *Lanium*, and *Pleuranthium*, which have been above mentioned as distinct genera, and *Epicladium*, of which the typical species, *E. aurantiacum*, Batem., seems to be referrible rather to *Cattleya*. The remaining sections, comprising the great mass of the species, appear to be reducible to four primary sections and a number of subordinate less definite series. These sections are:—1. *Barkeria*, and 2. *Encyclia*, with the labellum adnate only at the base or below the middle of the column, the former containing but very few species, forming Knowles and Westcott's proposed genus *Barkeria*; whilst the larger group, *Encyclia*, may be subdivided into three series, and would include the proposed

genera *Dinema*, Lindl., *Prosthechea* or *Epithecium*, Kn. and Westc., and *Encyclia*, Hook. 3. *Auliseum*, and 4. *Euepidendrum*, with the unguis of the labellum adnate to the top of the column, or nearly so, the lamina appearing sessile. *Auliseum*, in two series, would include *Auliza*, Salisb., and *Anacheilum*, Hoffmans.; and *Euepidendrum*, in ten series, would include *Ærstedella*, Reichb. f., *Amphiglottis*, Salisb., *Pseudepidendrum*, Reichb. f., *Physinga*, Lindl., and *Nanodes*, Lindl. To these four sections I would doubtfully add a fifth, under the name of *Psilanthemum*, for the *E. Stamfordianum*, Batem. (*E. basilare*, Link, Kl., and Otto, *E. cynostachys*, Reichb. f.), which, from its leafless flowering scape and some differences in the shape and arrangement of the pollen-masses, might well be admitted as a distinct genus.

Broughtonia, R. Br., three or four West-Indian species, and *Cattleya*, Lindl., about twenty species, are both united by Reichenbach with *Epidendrum*; and the following genera, with eight pollen-masses, are referred by him to *Bletia*, an arrangement in which I am unable to concur, especially in ignorance of the characters he would assign to the compound genera thus formed.

Læliopsis, Lindl., comprises three or four West-Indian species, with the flowers nearly of *Lælia*, but with the reduced upper pollen-masses and the habit rather of *Tetramicra*. The plant Lindley received from Hinds as Chinese, and which he published first as a *Broughtonia* and then as a *Læliopsis*, has been satisfactorily shown by Reichenbach to have been really Mexican and a true *Epidendrum*, nearly allied to *E. nævosum*, Lindl.

In *Tetramicra*, Lindl., about six species, we would include *Leptotes*, Lindl., of which the pollen-masses were described as two only in the lower series, evidently by some mistake. I find four in the flowers examined, as figured in Bot. Mag. t. 3734. *Tetramicra tenera*, Griseb., is a true species, with the labellum of *Leptotes*. *Bletia pratensis*, Reichb. f., and *B. Schomburgkii*, Reichb. f., appear to me to be but very slight varieties of the original *T. rigida*. *T. platyphylla*, Griseb., is rather a true *Bletia*. *T. montana*, Griseb., constitutes the above-mentioned genus *Octadesmia*.

Brassavola, R. Br., about twenty species, calls for no remark except that *B. glauca*, Lindl., and *B. Digbyana*, Lindl., which have not the characteristic perianth of *Brassavola*, might be better placed in *Lælia*, near those Brazilian species which have the petals scarcely broader than the sepals.

Lælia, a well-known and splendid genus of about twenty species,

Many
handled
Aug, 1851

is so closely allied in every respect to *Cattleya*, that one has great hesitation in accepting the technical distinction of the eight pollen-masses in two series instead of the single series of four, especially as hybrids are so readily produced in cultivation in which the number of pollen-masses is variable. It was thought at first that the character was accompanied by a difference in habit; but this has not been since confirmed, for several species, first described and figured as *Cattleyas*, on account of their habit, have been subsequently found to have the eight pollen-masses of *Lælia* (Bot. Reg. t. 1172 and 1838, t. 2; Bot. Mag. t. 3656, 3711, 3910, 4700).

Schomburgkia, Lindl., about twelve species, and *Sophronitis*, Lindl., four or five Brazilian species, call for no special remark on the present occasion.

Tribe 2. VANDEÆ.

This vast tropical tribe remains, with very few exceptions, as circumscribed by Lindley. The plants are mostly epiphytical and frequently pseudobulbous. The inflorescence is generally lateral, although in a few genera it terminates leafy stems. The essential character resides in the anther and pollinary apparatus. The anther, operculate and deciduous as in *Epidendræ*, is more closely incumbent on the rostellum, and when mature usually appears one-celled or nearly so; the two cells, perhaps always distinct in the young bud, become confluent when open, or are only separated by a partially raised line in the anther-case, and in all probability are always divaricate, not parallel as in *Epidendræ*. The pollen of each cell is a waxy, globular, ovoid or oblong mass, not tapering to a point or caudicle, and either entire or more or less divided into two by a transverse or oblique furrow or section. Thus the pollen-masses, when four in the anther, are fore and aft in each pair, not all four collateral and parallel, as in most *Epidendræ*. When the flower opens, the anther-case is very readily detached, leaving the two pollen-masses or pairs of pollen-masses belonging to the two cells separately and firmly attached to a scale or plate which becomes detached from the back of the rostellum. This scale or plate, with the attached pollen-masses, constitutes the *pollinarium*. When it is small and thick, and almost wholly viscid, it assumes the appearance of a gland, and is so denominated; but in many cases it takes the shape of a broad scale, or is prolonged into a linear or oblong, single or sometimes double, stipes, bearing the pollen-masses at the further end; but

the under surface at the lower end is always highly viscid, and the whole pollinarium is readily carried off by any insect or other foreign body with which it may come in contact, giving it a fair chance of being lodged on the stigma of another flower. It is that form of pollinarium in which the pollen-masses and gland are separated by a stipes which has been erroneously described as pollen-masses with a caudicle and gland, and has led to confounding it with the true caudicles and gland of *Ophrydeæ* and of *Calanthe* and some other *Epidendreæ*.

The above characters appear to draw a very marked line of distinction between *Epidendreæ* and *Vandææ*; and out of 88 genera and above 2000 species of the former, and 130 genera and about 1400 species of the latter tribe, there are not, I believe, half a dozen tolerably well-known species as to which there may be any doubt of the tribe to which they should be referred. But the division of the *Vandææ* into subtribes is much more difficult, and as yet very vague in its results. Habit, and even geographical distribution, has often to be more relied upon than any absolute character; and the eight following ones which we have adopted for the 'Genera Plantarum' may very possibly, when the doubtful genera become better known, require considerable modification.

Subtribe 1. *EULOPHIÆÆ*.—The three genera here collected are mostly terrestrial, producing pseudobulbs which bear a few long plicately-veined leaves, and leafless flowering scapes proceeding from the rhizome at the base of the pseudobulb. In a few species, however, the flowering-stem itself is leafy, and thickens at the base in a pseudobulb. The habit of the subtribe is therefore that of most *Cymbidiææ*, from which it is chiefly distinguished by the labellum more or less produced at the base into a spur, rarely reduced to a short gibbosity. The principal genus, *Eulophia*, R. Br., including *Orthochilus*, Hochst., has about fifty species, chiefly African, tropical or southern, with a few from the Indo-Australian region, and perhaps one true *Eulophia* from Brazil. The great mass of these species have simple racemes of rather showy flowers on leafless scapes, but two or three South-African ones have the leafy flowering-stems of the American *Galeandras*; and a very few, also African, tropical or southern, have small flowers in branching racemes. Blume proposed uniting with *Eulophia*, not only the closely allied *Galeandra*, but also *Zygopetalum* and some other *Cyrtopodieæ*, in which I am unable to concur, the structure of the

perianth, with a mentum instead of a spurred labellum, being so very different. *Lissochilus*, R. Br., including *Hypodematium*, A. Rich., is a purely African genus, tropical or southern, of about twenty-five species, differing from the genuine *Eulophias* with leafless flowering-scapes chiefly in the large petals, always broader and more coloured than sepals an approach to which character may be observed in *Eulophia herbacea*, Lindl., and a few allied Asiatic species. *Galeandra*, Lindl., comprises half a dozen American species, with the inflorescence terminating the leafy stems, as in the two or three abnormal species of South-African *Eulophias*, from which they differ chiefly in the broad funnel-shaped spur of the labellum, and in the gland or scale of the pollinarium not at all or scarcely produced into a stipes. The three genera, however, of Eulophiæ might almost equally well be considered sections of one genus.

Subtribe 2. CYMBIDIÆ.—The plants of this subtribe have generally the habit nearly of Eulophiæ and of some Cyrtopodiæ, but have no spur to the labellum nor mentum to the perianth. They are terrestrial, or more or less epiphytical; the leaves, usually large and plicate or many-nerved, are often borne on pseudobulbs; the racemes, simple or rarely branched, are on leafless scapes, or in three genera terminate the leafy stems. The pollen-masses are sessile on the scale-like gland of the pollinarium, rarely produced into a short single or double stipes. The eleven genera are all from the Old World, one only of the somewhat anomalous ones (*Polystachya*) being also represented in America.

Cymbidium itself, including *Iridorchis*, Blume, has about thirty species, chiefly Asiatic or Australian; the two African species referred to it by Lindley have been shown by Harvey to belong to *Eulophia*; but the *C. Sandersonii*, Harv., from South Africa, and an allied species from tropical Africa, appear to be true *Cymbidia*. The pollen-masses in this and the two following genera have usually within the anthers a granular appendage, like that of *Epidendrum*, attached to their base and lying along their outer edge; but in *Epidendrum*, the anther-cells being parallel, the appendages of the two cells are contiguous and parallel, readily uniting in a single lamina ascending from the base; whereas in *Cymbidium*, the anther-cells being divaricate, the appendages are also divaricate, united by their bases only into a single transverse linear lamina, attached by the centre, and, after dehiscence, placed

between the pollen-masses and the scale-like gland of the rostellum, free from both, except in the centre. This pollinary appendage readily shrivels up in drying, and has been generally overlooked; but I have always seen it very prominent and of a bright yellow pollen-colour in *Cymbidium giganteum*, and, with care, seen it very distinctly in buds just open of dried specimens of several species of *Cymbidium*, *Ansellia*, and *Grammangis*. It is also well figured in Blume's plate of *Iridorchis*, and in Griffith's of a *Cymbidium*, Ic. Pl. Asiat. t. 321. *Ansellia*, Lindl., consists of three or four marked varieties, or, possibly, distinct species, all African and mostly tropical, very nearly allied to *Cymbidium*, although the inflorescence is terminal on the leafy stems, and the column, shortly and broadly produced at the base, is exceptional in the subtribe. *Grammangis*, Reichb. f., has also most of the characters of *Cymbidium*, but has been rightly distinguished by Reichenbach, chiefly by the form of the perianth. It was founded on the *Grammatophyllum Ellisii*, Lindl., from Madagascar, to which must evidently be added the *Cymbidium Huttonii*, Hook., Bot. Mag. t. 5676, said to be from Java; but both species being only known from cultivated specimens, their origin may not be quite certain.

Cremastra, Lindl. (*Hyacinthorchis*, Blume), a single Japanese species, and *Cyperorchis*, Blume, from the Indo-Malayan region, have been well distinguished by Blume from *Cymbidium*, to which they had been referred; and I cannot find in the dried flowers any trace of the pollinary appendage of *Cymbidium*. To Blume's typical species of *Cyperorchis* I would add *Cymbidium elegans*, Lindl., *C. Mastersii*, Lindl., and probably *C. cochleare*, Lindl.; but I have not succeeded in seeing the pollinarium of the latter species.

Geodorum, Jacks. (including *Cistella*, Blume), nine species from the Indo-Australian region, *Grammatophyllum*, Blume (including *Gabertia*, Gaudich., and *Pattonia*, Wight), six Indo-Malayan species, and *Dipodium*, Br. (including *Leopardanthus*, Blume, and *Wailesia*, Lindl.), six species from the Indo-Australian and South-Pacific regions, have all been well characterized, and require no comment. *Thecostele*, Reichb. f., is a single Malayan species, with a very curiously shaped perianth; but I am unable to see any affinity with the American Stanhopiæ (Eborilingues, Reichb.), with which Reichenbach associates it. It appears to me to be more nearly related to Cymbidiæ than to any other subtribe, notwithstanding

the coriaceous, less prominently veined leaves. I find, also, in the only flower retaining its pollinarium which I could examine, the pollen-masses sessile on the back of the rostellum, the gland or scale not being yet detached. The slender filiform stipites represented in Parish's original drawing, rather too thickly delineated in Fitch's plate (Trans. Linn. Soc. xxv. t. 29), appear to me to be the viscum which in Vandææ so firmly attaches the pollen-masses to the gland or stipes, and which is here more than usually abundant, and readily stretches into elastic threads.

Bromheadia, Lindl., two Malayan species, and *Polystachya*, Hook., about thirty species, chiefly African, but extending also into the Indo-Malayan region, and sparingly represented in tropical America, are both somewhat anomalous genera, with the inflorescence terminating leafy stems, and often branched, but with floral characters connecting them rather with Cymbidiææ than with any other subtribe.

Subtribe 3. CYRTOPODIÆ.—I have here collected twenty-one genera, whose general character is to have the prominent mentum of Maxillariææ with the foliage and habit of Cymbidiææ, thus forming a connecting link between those two subtribes, but with limits not always quite so definite as could be wished, for there are here and there species offering exceptions to one or other of the characters. The first three genera are terrestrial, without fleshy pseudobulbs, although the base of the leafy stems often thickens into a hard tuber. The others are epiphytical, and usually, if not always, pseudobulbous. The leaves are generally plicate or with prominent parallel ribs, as in the two preceding subtribes, and the flowering-scapes are leafless in all except *Govenia*. The only exception to the mentum is in *Aganisia*, which, however, is too closely allied to *Zygopetalum* to be removed from the subtribe. The pollinarium has generally the stipes much more developed than in Cymbidiææ. In geographical distribution, one small, rather anomalous genus, *Plocoglottis*, is exclusively Malayan, and a monotypic one, *Pteroglossaspis*, is endemic in tropical Africa; the remainder are all American, though the typical one, *Cyrtopodium*, extends also to tropical Africa and Asia.

The Malayan genus *Plocoglottis*, about eight species, has been well illustrated by Blume, but its systematic position may be as yet doubtful. The anther is more distinctly two-celled than is usual in Vandææ, and the two filiform slender stipites to the pollinarium are exceptional in the subtribe. Yet it has appeared to

me to be more nearly related to *Cyrtopodiæ* than to *Cymbidiæ*, to which, in some respects, it might be transferred.

Cyrtopodium, Br., now consists of about twenty species, dispersed over tropical America, Africa, and Asia. It was originally founded on the *C. Andersonii*, Br., which, with a few closely allied American species, has the raceme branched and the lateral sepals only very shortly adnate to the basal projection of the column, and was extended to embrace several Old-World species with simple racemes and the lateral sepals adnate to the end of the basal projection. Lindley afterwards proposed separating the latter generically, under the name of *Cyrtopera*. But the geographical distinction can no longer be maintained, for the American *C. Woodfordi* has the characters of *Cyrtopera*. Moreover, the Asiatic *C. flava*, Lindl., and the Mascarene *C. plantaginea*, Lindl., have the lateral sepals almost free from the basal projection, as in the typical *Cyrtopodium*, whilst the raceme is simple, as in *Cyrtopera*. The whole, therefore, are now reunited into one fairly natural genus under the original name. *C. foliosa*, Lindl., however, from South Africa, is not a congener, but appears to be a *Eulophia*, near *E. cochleata*, Lindl.

Govenia, Lindl., including *Eucnemis*, Lindl., consists of about ten American species, exceptional in the subtribe by the inflorescence terminating leafy stems. *Pteroglossaspis*, Reichb. f., a single Abyssinian species, is the only exclusively Old-World genus of the subtribe with fleshy pseudobulbs.

Zygopetalum is an American genus of about forty species. I cannot concur with Blume in uniting it with *Eulophia*, but I would add to it several small genera proposed by Lindley or Reichenbach, most of which have, indeed, been already joined with it by Reichenbach. Amongst these I would recognize the following six as sections:—1. *Zygopetalum* proper; 2. *Zygo-sepalum*, Reichb. f.; 3. *Huntleya*, Batem., including *Galeottia*, A. Rich.; 4. *Bollea*, Reichb. f.; 5. *Warszewiczella*, Reichb. f., including *Pescatorea*, Reichb. f.; and 6. *Promenæa*, Lindl., excluding the racemose species and including *Kefersteinia*, Reichb. f., and *Chaubardia*, Reichb. f.

Grobya, Lindl., two Brazilian species, calls for no comment. *Cheiradenia*, Lindl., one Guiana species, is not sufficiently known to be certain of its affinities, and our specimens do not afford materials for a proper examination.

Aganisia, Lindl. (*Koellensteinia*, Reichb. f.), has about six

species, exceptional in the subtribe in the base of the column not being produced. But the habit and other characters indicate a much closer affinity to *Zygopetalum* than to any one of the Cymbidiæ, and it is still further removed from the Oncidiæ. Besides Lindley's typical species and Reichenbach's *A. lepidæ*, we would include in *Aganisia* the *Warrea cinerea*, Lindl. (*Zygopetalum tricolor*, Lindl.), and *Promenæa graminea*, Lindl. *Acacallis*, Lindl., a single North-Brazilian species, is referred by Reichenbach to *Aganisia*, but it appears to me to be much nearer to *Zygopetalum*; and the curious appendage to the labellum and large auricles to the column may warrant the retaining it as a distinct genus. *Eriopsis*, Lindl., should probably include *Pseuderiopsis*, Reichb. f. *Warrea*, Lindl., becomes reduced to two Peruvian or Columbian species, the original station given as Brazil having been probably a horticultural mistake. *Lycormium*, Reichb. f., besides the typical species, should include *Peristeria cerina*, Lindl., and perhaps also *P. guttata*, Knowles & Westc., judging rather from the description than from the analysis in the plate. *Batemannia*, Lindl., reduced to the original Guiana species, appears to be very different both in habit and character from *Huntleya Meleagris*, Lindl., and the allied species referred by Reichenbach to *Batemannia*, but which we would include in *Zygopetalum*. *Bifrenaria*, Lindl., about ten species, remarkable for the very prominent, often spur-like, mentum and the double (short or long) stipes of the pollinarium, should include *Stenocoryne*, Lindl. This species, in which the spur-like mentum is very long and slender, was generically distinguished by Lindley on the supposition that the gland or scale of the pollinarium was double, each one produced into a distinct stipes, and so it is drawn in the sketch in Lindley's herbarium; but in Spruce's specimens, n. 2935, identified by Lindley as the true *Stenocoryne*, I find the two stipites connected at the base into a single glandular scale. *Xylobium*, Lindl., about sixteen species, is usually regarded as a section of *Maxillaria*; but the foliage and inflorescence, together with the lengthened stipes of the pollinarium, appear to be sufficient to maintain it as a distinct genus, more closely allied to *Bifrenaria*. *Lacæna*, Lindl. (*Navenia*, Klotzsch), has two Central-American species, nearly allied to *Bifrenaria* and *Xylobium*.

Lycaste, Lindl., about twenty-five species, should, I think, include *Paphinia*, Lindl., and *Colax*, Lindl., and is closely allied to the typical *Anguloa*, Ruiz and Pav., of which there are three

Columbian and Peruvian species. The passage from the nearly globular perianth of *Anguloa* to the expanded one of *Lycaste* appears to be gradual through the various forms referred to *Colax*, judging at least from the several published figures. *Chondrorhyncha*, Lindl., one or two Columbian species, appears from Lindley's herbarium and notes to be nearer to *Zygopetalum* than to *Stenia*, next to which Reichenbach would place it; but I have not had the means of examining any flower myself. Lastly, *Gongora*, Ruiz and Pav., of which about twenty species have been published, connects the subtribe with that of Stanhopiæ; and I quite concur with Reichenbach in including in it *Acropera*, Lindl. In the cultivated specimens of this plant Darwin found the stigma always imperfect, and suggested the possibility that it might be the male form of some species, of which the female might be different enough to have been placed in some other genus. But Bourgeois' Mexican specimens, with perfectly organized stigmas and well-ripened capsules, are in other respects perfectly similar to the cultivated ones.

egeliella *Paradisanthus*, *Kegelia*, *Cæliopsis*, and *Sievekingia*, Reichb. f., are all monotypic genera unknown to me, and not sufficiently characterized to judge of their immediate affinities; but they all appear to belong to the subtribe Cyrtopodiæ, and are very probably referrible to some of the above-mentioned genera.

Subtribe 4. STANHOPIÆ.—This subtribe, corresponding nearly to Reichenbach's group of Eborilingues, consists of ten tropical-American genera, distributed by Lindley in his *Catasetidæ* and *Maxillaridæ*. They form a natural group, much better represented in our plant-houses than in herbaria, and readily recognized, though very difficult to characterize. The habit is generally that of the preceding tribes, all epiphytes with pseudobulbs bearing one or very few usually large leaves, either plicate or prominently ribbed. The leafless scapes bear a loose raceme of few usually large flowers, often very irregular in their shapes. The whole perianth, or, at least, the labellum, is very fleshy; and this is the main character relied upon for the distinction of the subtribe. There is no mentum or spur. The pollinarium has generally a well-developed stipes, and frequently a large thick gland. The nine genera, *Coryanthes*, Hook., *Stanhopea*, Frost, *Houlletia*, Brongn., *Peristera*, Hook., *Acineta*, Lindl., *Catasetum*, A. Rich., *Mormodes*, Lindl., *Cycnoches*, Lindl., and *Polycynis*, Reichb. f., have all been well illustrated in horticultural

publications, and require no comment on the present occasion. To these nine I have with some doubt added *Chrysocynis*, Reichb. f., a single species from New Granada, which the author compares with *Trigonidium*, but seems to me to be more nearly allied to *Cynoches*, although it be exceptional in the subtribe in its peculiar habit and single-flowered scapes or peduncles.

Subtribe 5. MAXILLARIÆ.—The genera here included are all American and epiphytical, and have the mentum of *Cyrtopodiæ*; but the leaves are coriaceous, fleshy, or herbaceous, without prominent parallel ribs, and the peduncles or scapes are almost always single-flowered. The rhizome either bears pseudobulbs with one or two leaves, or is produced into ascending or erect stems with closely distichous, often equitant leaf-sheaths, with more or less developed laminae. Of the nine genera we have referred to, two or three of the smaller ones are as yet rather doubtful in their affinities; generally they connect in some measure the *Cyrtopodiæ* and the *Stanhopieæ* with the *Oncidiæ*.

Stenia, Lindl., two species, one from Guiana, the other from Columbia (the latter figured by Reichenbach in Saund. Ref. Bot. t. 107, as a *Chondrorhyncha*), is only known to me from published figures and from the sketches in herb. Lindl., from which it would appear to have the fleshy labellum and the pollinarium of *Stanhopieæ*, but with the prominent mentum, foliage, and inflorescence of *Maxillariæ*. *Schlimmia*, Planch., three very closely allied Columbian species, with a peculiarly shaped perianth, has all the characters of *Maxillariæ*, except that the scapes have several, though but few, large flowers. *Clowesia*, Lindl., a single Brazilian species, is only known from a single scape in herb. Lindl. and horticultural reports as to its foliage. It is as yet, therefore, very doubtful as to its affinities.

Mormolyce, Fenzl, is a single Mexican species, which Lindley had referred to *Trigonidium*; but the perianth has none of the peculiarities of that genus, and indicates a much closer affinity with *Maxillaria*, from which, indeed, there is very little to distinguish it generically. *Scuticaria*, Lindl., contains two very closely allied species with a very peculiar habit, derived chiefly from the very long, terete, fleshy leaf continuous with the pseudobulb, the floral characters being nearly, but not quite, those of *Maxillaria*. The two species have been placed, the one in *Maxillaria*, the other in *Bifrenaria*, on the supposition that the pollen-masses

were sessile on the gland or scale in the one, and separately stipitate in the other. The fact appears to be, however, that the stipites exist in both species, but are reduced to a slightly prominent ring or are very short (as figured, Bot. Mag. t. 3573) in *Scuticaria Steelii*, Lindl., whilst they are more conspicuous in *Bifrenaria Hadwenii*.

Maxillaria, the principal genus of the subtribe, was at one time a kind of receptacle for a great variety of American Vandææ, and has since been variously extended or cut up. Reduced to Reichenbach's section *Colacastrum*, it is a not unnatural genus of above a hundred species, distributed into two generally distinct series, but which occasionally run into each other:—1. *Acaules*, in which the only leaves are the one or two which terminate the pseudobulbs, the 1-flowered scapes proceeding from the short rhizome. This series corresponds to the genus *Psittacoglossum* of Llave and Lexarsa, who applied the name of *Maxillaria* to Lindley's *Xylobium*. It includes also *Dicrypta* or *Heterotaxis* of Lindley. 2. *Caulescentes*, in which the rhizome is more or less extended beyond the pseudobulbs into a stem clothed with distichous leaf-sheaths, the upper ones often bearing leafy laminæ, the peduncles axillary in the lower leaf-sheaths; the habit thus approaching that of *Camaridium*.

Camaridium, Lindl., and *Dichæa*, Lindl., of about twelve species each, and *Ornithidium*, Salisb., about twenty species, are genera evidently very nearly allied to each other, but very difficult to characterize efficiently. In many species the floral structure is as yet imperfectly known. All have the rhizome more or less produced into erect ascending or branching stems, with distichous, often equitant leaf-sheaths, mostly bearing leafy laminæ, and the 1-flowered peduncles or pedicels axillary. In *Camaridium*, which in many respects approaches the caulescent *Maxillarias*, pseudobulbs, bearing a single large petiolate coriaceous leaf, are often produced. These pseudobulbs never appear in *Dichæa*. In both these genera the peduncles are solitary. *Ornithidium* has occasionally pseudobulbs, and, though showing great affinity to *Camaridium* and *Dichæa*, differs from *Maxillariæ* generally in the peduncles or pedicels clustered in the axils, in the less prominent or obscure mentum, and the pollen-masses have sometimes appeared to me to be free from the stipes. The structure of the flowers, however, of most species requires a much more perfect investigation than can be made with our specimens. The genus

appears to comprise at least four distinct types of structure, represented by the original *O. coccineum*, Salisb., by *O. giganteum*, Lindl., *O. suave*, Lindl., and *O. densum*, Reichb. f., respectively. The genus *Siagonanthus* and the two species *Scaphyglottis parviflora* and *S. pendula* of Poeppig and Endlicher (Nov. Gen. et Sp. t. 67, 97, 98) would all three enter into the group of *O. suave*.

Subtribe 6. ONCIDIÆ.—The Oncidiæ comprise a large proportion of the pseudobulbous epiphytes familiar to our Orchid growers, and copiously illustrated in our horticultural publications. The genera are all American, and have a characteristic vegetation. The short rhizome bears stems, terminating usually in a pseudobulb, crowned by one or, rarely, two leaves, and under the pseudobulb are a few distichous leaves or leaf-sheaths, in the axils of which are the leafless peduncles or scapes; the fleshy pseudobulbs apparently formed by the consolidation of the uppermost leaf-sheath with the enclosed terminal bud. Sometimes the pseudobulbs are almost sessile on the rhizome, and the scapes arise also from the rhizome close to their base; and in a few genera the terminal pseudobulb is wanting, or only very tardily thickened out, and the leaves are either distichously imbricate on the short stem, or form with the peduncles an apparently radical cluster. The leaves are fleshy, coriaceous, or, rarely, membranous, neither plicate nor prominently many-ribbed. The column is not produced at the base, forming no real mentum to the perianth; but in a few genera the labellum or the lateral sepals, or both, are produced at their base into a spur. The pollinarium is usually well developed with a distinct stipes. The thirty-five genera we have admitted into the subtribe may be distributed into five series, distinguished chiefly by the form of the perianth.

Series 1. *Perianthium calcaratum*.—This includes six genera. In four of them the spur of the labellum, often double, is enclosed within a single spur, formed by the union of the base of the two lateral sepals. *Cryptocentrum* is a new genus I have proposed for an Ecuador plant of Jameson's, in which the very long slender spur of the small flower is closely appressed to the ovary, and enclosed with it in the sheathing bract. *Diadenium*, Poepp. and Endl. (*Chænanthe*, Lindl.), two species, and *Comperettia*, Poepp. and Endl., two or three species, have the spur slender, but diverging from the ovary. The flowers in *Diadenium*

are small and numerous in a much-branched panicle, larger and fewer in a simple raceme in *Comparettia*. The fourth genus, *Scelochilus*, Klotzsch, three or four species, is perhaps too closely allied to *Comparettia*, but has a much shorter spur and some other slight differences. In the two remaining genera of the series, *Trichocentrum* and *Rodriguezia*, the spur is on the labellum only, projecting between the bases of the lateral sepals. *Trichocentrum*, Pœpp. and Endl., about eight species, is very well characterized by the short column connected with the labellum into a broad tube or cup, by the rather long spur, and by the inflorescence. *Plectrophora*, Focke, united by Lindley and by Reichenbach with *Trichocentrum*, has a different habit; the spur is certainly formed chiefly by the lateral sepals, and it appears to me to be a true *Comparettia*. *Rodriguezia*, Ruiz and Pavon, about twenty species, is a well-established genus, with a slender column and a short spur to the labellum. It was originally confounded by Lindley with *Gomesa*, R. Br., which has no spur; and when he afterwards separated the spurred species he unfortunately overlooked the fact that these were the true *Rodriguezias* of Ruiz and Pavon, and gave them the new name of *Burlingtonia*, as since pointed out by Reichenbach, who reduces the *Gomesa*, R. Br., or *Rodriguezia*, Lindl., to *Odontoglossum*. In *R. secunda*, H. B. and K., and *Burlingtonia maculata*, Lindl., the spur is reduced to so short a gibbosity as almost to justify the connexion of *Rodriguezia* with *Gomesa*.

Series 2. *Labellum ecalcaratum basi columnæ adnatum*.—Four genera, *Trichopilia*, *Aspasia*, *Cochlioda*, and *Dignathe*. *Trichopilia*, Lindl., about sixteen species, should, I think, include *Pilumna*, Lindl., *Leucokyle*, Kl., *Helcia*, Lindl., and, perhaps, *Oliveriana*, Reichb. f. *Helcia* was distinguished by Lindley as having the labellum quite free; but according to Reichenbach this is a mistake, and it is really adnate at its base along the centre, as in other *Trichopiliæ*. I have only seen a single flower in herb. Lindl., and could not verify the point. *Oliveriana*, Reichb. f., is only known to me from Reichenbach's character, in which I can see nothing to separate it from *Trichopilia*, except that the peduncle or scape bears six flowers instead of only from one to three. *Aspasia*, Lindl., including *Trophianthus*, Scheidw., about six species, is reduced by Reichenbach to a section of *Odontoglossum*, from which it appears to me to differ essentially in the claw of the labellum closely united with the column

and some other characters. *Cochlioda*, Lindl., about six species, is a very natural genus, with the perianth of an *Epidendrum*, but with the anther and pollinarium as well as the habit of the subtribe Oncidiæ. I am at a loss to understand upon what grounds Reichenbach has referred it to his genus *Mesospinidium*, founded upon one of the paniculate small-flowered species of *Odontoglossum*. *Dignathe*, Lindl., is a Mexican plant, represented by a single specimen in herb. Lindl., the structure of the flower only known from his sketches and description, and requiring some further investigation.

Series 3. *Perianthii tubus supra ovarium ovoideus v. globosus, apice clausus*.—Two curious and apparently very distinct genera—*Saundersia*, a single Brazilian species, only known to me from Reichenbach's figure and description, and *Bractia*, Reichb. f. (*Oncodia*, Lindl.), three Columbian species.

Series 4. *Labellum liberum, ecalcaratum. Caulis sæpissime pseudobulbo 1-foliato terminatus*. Fifteen genera, of which ten, *Odontoglossum*, *Oncidium*, *Miltonia*, *Brassia*, *Solenidium*, *Leiochilus*, *Sigmatostalix*, *Erycina*, *Gomesa*, and *Abola*, have the sepals all, or at least the lateral ones, spreading; and five, *Neodryas*, *Trizeuxis*, *Ada*, *Sutrina*, and *Trigonidium*, have them erect, at least at the base, or united into a tube. A very few species of *Oncidium* itself appear not to form the pseudobulb otherwise universal in the series.

Odontoglossum, H. B. & K., is now supposed to have above eighty known species, a large number of which have been well illustrated in our horticultural publications, and especially in Bateman's splendid monograph. The genus is upon the whole a natural one, though sometimes very difficult technically to separate from *Oncidium*, and occasionally thrown into confusion by the introduction of species which do not correspond to the generic character. Thus *O. roseum*, Lindl., is a *Cochlioda*; *O. vexillare*, Reichb. f., has rather the character of *Miltonia*, &c. [= ONC] No satisfactory subdivision of the genus has yet been carried out. Lindley proposed six sections, founded sometimes on the form of the clinandrium, sometimes on the colour of the flower; but the clinandrium varies in its development and lobes from species to species, and Lindley's sections have proved neither natural nor well defined. The most distinct-looking is perhaps *Myanthium*, consisting of a few species, with large panicles of numerous small flowers; but I have been unable to point

out any special character in their structure. *Mesospinidium*, Reichb. f., was originally founded on a plant which the collector reported as resembling in habit this group of *Odontoglossum*; and I can find neither in Reichenbach's character nor in his figure (Xen. Orch. t. 16), nor yet in the loose flowers in herb. Lindl. received from him, any thing to separate it from these *Myanthis*, amongst which it appears to be very close to, if not identical with, *O. ramulosum*, Lindl. The species since referred by Reichenbach to *Mesospinidium* are very different in aspect as in structure, and belong to *Cochlioda*, *Abola*, or *Ada*.

Oncidium, Sw., now reckons above two hundred published species, including probably a considerable number of horticultural varieties. It is, with few exceptions, a natural genus, now well known and rarely confounded with its allies. Lindley distributed the species into fourteen series, of which the following four are the most distinct; but even these can scarcely be considered sections. 1. *Microchila*, a few species forming the genus *Cyrtochilum*, H. B. & K., in which the middle lobe of the labellum is small and narrow, whilst in the normal species it is peculiarly large, broad, and flat. 2. *Equitantia*, for *O. iridifolium*, H. B. & K., and two or three allied species, all small with distichous leaves, and exceptional in the genus as not forming the terminal pseudobulb. But *O. onustum*, Lindl., and *O. crista-galli*, Reichb. f. (*O. decipiens*, Lindl.), placed at first amongst *Equitantia* as nearly resembling *O. iridifolium*, have since been removed as really thickening at the end into the normal pseudobulb. 3. *Teretifolia*, a few species with short fleshy terete leaves on small pseudobulbs; and 4. *Planifolia*, comprising the great mass of species, of which no satisfactory subordinate arrangement has yet been proposed.

Miltonia, Lindl., about ten species, *Brassia*, R. Br., about twenty species, *Solenidium*, Lindl., a single one, and *Leiochilus*, Kn. & Westc. (*Cryptosaccus*, Scheidw.), including *Rhynchostele*, Reichb. f., four or five species, are all very near *Oncidium*, with which Reichenbach proposes to unite them; but all appear to have very fairly definite generic characters. So also has *Sigmatostalia*, Reichb. f., as to his *S. pictum* and *S. radicans*. But *Specklinia graminea*, Poepp. & Endl., which he also refers to this genus, does not well correspond with the character given, judging at least from the figure and description, for I have not seen any specimen. *Erycina*, Lindl., is a single, very distinct, Mexican species, placed

originally in *Oncidium*, but with a rostellum approaching that of *Zygostates*, and the habit nearly of *Ionopsis*, without pseudobulbs in the specimens I have seen; but, according to Kunth, the upper leaf-sheath thickens into a pseudobulb, as in the rest of the present series.

Gomesa, R. Br., six species, confounded by Lindley, as above mentioned; with *Rodriguezia*, Ruiz & Pav., has been united by Reichenbach with *Odontoglossum*, and *Abola*, Lindl., a single species, with his *Mesospinidium*; but both appear to me to be sufficiently characterized to be retained as substantive genera. *Neodryas*, Reichb. f., three species, differs very little from *Oncidium*, except in the rather less spreading perianth. *Trizeuxis*, Lindl., *Ada*, Lindl., and *Sutrina*, Lindl., are all three monotypic, but well established. Reichenbach in uniting *Ada* with his *Mesospinidium*, distinguishes two species, Lindley's *Brassia cinnabarina* and *Ada aurantiaca*; but after a careful comparison of the specimens the two appear to me to be quite identical. *Trigonidium*, Lindl., is a natural genus of seven or eight species, strongly characterized by the union or connivence of the sepals in a triangular tube.

Series 5. *Labellum liberum, ecalcaratum. Caulis foliatus brevis, ebulbosus*.—Eight genera, all distinct and well established:—*Ionopsis*, H. B. & K. (*Ianthe*, Hook., *Cybelion*, Spreng.), ten published species, but several of them varieties of *I. pulchella*; *Cryptarrhena*, R. Br. (*Orchidofunkia*, A. Rich.), two species; *Ornithocephalus*, Hook., about eight species; *Quekettia*, Lindl., a single one; *Zygostates*, Lindl. (*Dactylostyles*, Scheidw.), three or four species; *Phymatidium*, Lindl., two species; *Chytroglossa*, Reichb. f., two species; and *Hofmeisterella*, Reichb. f., a single one.

Cohnia and *Papperitzia*, Reichb. f., genera founded on single herbarium specimens, are both unknown to me, and the characters given are not sufficient to judge of their affinities beyond referring them to the subtribe Oncidiæ.

Subtribe 7. SARCANTHÆ.—The chief character of this subtribe is vegetative. The genera are all epiphytical and never pseudobulbous. The stem or caudex, corresponding to the rhizome of the preceding subtribes, creeps and bears adventitious roots at least at the base, and often for its whole length. It is usually clothed with scarious or closely appressed leaf-sheaths; the leaves themselves are more or less distichous, fleshy, or

coriaceous, very rarely thin, never plicate. In some cases the end of the caudex or its branches becomes erect or pendulous, without roots and with more closely distichous small leaves. In a few genera these leafy stems are crowded on a very short creeping rhizome, or in a few species the whole stem or rhizome is very short, with a dense tuft of roots, and only one or two leaves, or none at all. The peduncles are always lateral, either evidently axillary or apparently leaf-opposed, or breaking irregularly through the leaf-sheaths as already explained. The flowers vary, solitary on the peduncles or more frequently racemose or paniculate. Of the thirty-two genera here included, five are exclusively American, the remainder limited to the Old World; all tropical, but a few species extend into South Africa or into eastern extratropical Asia.

Notwithstanding considerable differences in the floral structure, the genera are difficult to define accurately or to form into natural groups. Characters very constant in some instances are very much the reverse in other genera evidently natural. The best arrangement I have been able to devise is perhaps too artificial, the three following series being founded on the presence or absence of a mentum to the perianth, or of a spur to the labellum; and even this distinction is not always well marked. The mentum may be exceedingly short in some spurless species, and slightly prominent in some long-spurred ones; and I have reckoned as spurless a few where, although there is no spur at the base, the labellum has a spur-like gibbosity on the back far above the base.

Series 1. *Columna apoda. Labellum ecalcaratum.*—We have here first three American genera, *Lockhartia*, *Centropetalum*, and *Pachyphyllum*, with stems ascending erect or pendulous from a short rooting base, closely covered with the persistent sheaths of small distichous leaves. In *Lockhartia*, Hook., about ten species, and *Pachyphyllum*, H. B. & K., six or seven species, the pollen-masses, in those dried specimens which I have been able to examine, have appeared to me to differ from those of Vandææ generally in being more acuminate and free, or connected by a small gland. Reichenbach has, however (in Saund. Ref. Bot. t. 76), figured a *Lockhartia* with a true Vandæous pollinarium, the pollen-masses affixed to a distinct stipes. Lindley thought he had identified *Lockhartia* with the previously published *Fernandezia*, Ruiz & Pav.; but Ruiz and Pavon's figures of the

labella in their 'Prodromus,' and the specific characters in their 'Systema Vegetabilium,' clearly show that some at least of their species belong to *Dichæa*; and Reichenbach, in examining Ruiz and Pavon's Orchidæ in Boissier's herbarium, found the name of *Fernandezia* attached by them to species of *Dichæa*, *Centropetalum*, and *Maxillaria*. Their character not being sufficient to show which of the several genera with small distichous leaves they had specially in view, we must follow Reichenbach in rejecting their name altogether. In *Centropetalum*, Lindl., five or six species, we would also include *Nasonia*, Lindl., as a section, differing slightly in the lateral sepals being united to above the middle, instead of being free from the base. The pollinarium is also said to have a single entire stipes in *Nasonia*, and two distinct ones in *Centropetalum*; but in the latter case we find them often united to near the middle. *Nasonia sanguinea*, Lindl., can, however, scarcely be a congener; but we have no means of examining the structure of its flowers.

The same series would technically include four Asiatic genera with the ordinary habit of the subtribe, *Luisia*, *Cottonia*, *Stauropsis*, and *Arachnanthe*. *Luisia*, Gaud., about ten species, including *Birchea*, A. Rich., and *Mesoclastes*, Lindl., is a natural genus with definite characters. *Cottonia*, Wight, has two very distinct species—the original *C. peduncularis* from the Indian peninsula and Ceylon, and *C. Championi*, Lindl., from the eastern provinces and China, from which we can scarcely distinguish, even specifically, Thwaites's *Luisia bicaudata* from Ceylon. *Stauropsis*, Reichb. f., has about eight species, most of which were originally published as a section of *Vanda* under the name *Fieldia*, Gaudich., but rightly again separated generically by Reichenbach as differing as well in the form of the petals as in the want of any spur to the labellum. The name of *Fieldia* could not, however, be retained, having been previously taken up by a genus of Gesneriaceæ. I can, however, discover no difference between these species and Reichenbach's genus *Stauropsis*, and have therefore adopted the latter name for the whole group. *Arachnanthe*, Blume, six species, has been regarded by Lindley, as well as by Reichenbach, as a section of *Renanthera*. It is also nearly allied to *Vanda*; but the labellum is neither saccate nor spurred, as in those genera, and appears to be always articulate on the column. *Vanda Lowei*, Lindl., rightly added by Reichenbach to the *Arachnanthes*, is remarkable for the two very

differently shaped perianths on the same individual, and justifies the uniting with the genus *Vanda Cathcartii*, Lindl., forming Reichenbach's genus *Esmeralda*. I should also include in *Archianthe*, *Arrhynchium*, Lindl. (*Renanthera bilinguis*, Reichb. f.), and *Armadorum*, V. Breda (*Renanthera Sulingi*, Reichb. f.).

Series 2. *Columna in pedem producta. Labellum e calcaratum v. calcar a basi remotum*.—Seven genera, of which six are Indo-Australian and one Mascarene. *Phalænopsis*, Blume, comprises fifteen species from the Indo-Malayan region, and may be well divided into two sections—*Phalænopsis* proper, with very broad petals and the middle lobe of the labellum more or less distinctly two-horned or divaricately two-lobed, and *Stauroglottis*, Schauer, with the petals similar to the sepals or smaller and the middle lobe of the labellum entire; and in the section *Stauroglottis* may also be included *Polychilus*, v. Breda, with a remarkable fleshy dilated rhachis to the raceme. *Doritis*, Lindl., with a remarkable *Dendrobium*-shaped perianth and a peculiar habit, was originally founded on a Cochinchinese plant, to which Reichenbach added Lindley's *Dendrobium bifalce* from New Guinea; the specimens of both are far from satisfactory, yet sufficient to establish the genus, which might also include, though in a slightly different section, *Carteretia*, A. Rich., from New Guinea, *Aerides latifolia*, Thw., from Ceylon (from which *Phalænopsis Wightii*, Reichb. f., from the Peninsula, is scarcely specifically distinct), and *Aerides taniæ*, Lindl., from Nepal and Khasiya, making altogether a natural and fairly characterized genus of five or six species. Parish's Moulmein plant, referred by Reichenbach to his *Phalænopsis Wightii*, seems to me to be rather different, but the specimen is insufficient for accurate determination. *Rhynchostyles*, Blume, two or three Indo-Malayan species, is a well-marked genus as limited by Reichenbach, with the exception of *Vanda violacea*, Lindl., which appears to me to be rather a *Saccolabium*. *Sarcochilus*, R. Br. (*Dendrocolla*, Blume), is a genus of about thirty species, widely spread over the Indo-Australian and South-Pacific regions, in which the form of the labellum, and of its dorsal gibbosity, upon which several genera have been founded, varies from species to species. Blume proposed three fairly natural sections founded on the inflorescence:—1. *Cuculla*, which includes the genera *Orsidice*, Reichb. f., and *Thrixpernum*, Lour.; 2. *Fornicaria*, including *Cylindrochilus*, Thw., and one species at least of *Grosourdia*, Reichb. f.; and

3. *Tubera*, including *Ornitharium*, *Gunnia*, *Camarotis*, *Micropera*, *Stereochilus*, and *Chiloschista* of Lindley, most of which have been already reduced to *Sarcochilus* by Reichenbach. Amongst them *Chiloschista* (*Sarcochilus usneoides*, Reichb. f.) is remarkable for being entirely leafless, at least at the time of flowering. Reichenbach refers also *Pteroceras*, Hassk., to *Sarcochilus teres*, Reichb. f.; but Hasskarl's detailed character scarcely agrees with it, and I have not seen his specimen. I have already in 'Flora Australiensis,' given my reasons for not taking up Loureiro's barbarous name *Thrispermum* in the place of the well-known *Sarcochilus*. *Trichoglottis*, Blume, as to his *T. lanceolata* and *T. rigida*, and a third apparently undescribed species, is a fairly natural genus, closely allied to *Sarcochilus*, but has been made to include several very different plants. *T. retusa*, Blume, is unknown to me. *T. pusilla*, Reichb. f., from Lindley's sketch copied by Reichenbach, appears to be a *Saccolabium*. *T. pallens* and *T. philippinensis*, Lindl., should be referred to *Stauropsis*; and *T. quadricornutus*, Kurz, is probably a *Cleisostoma*. *Aeranthus*, Lindl., was originally founded on two Mascarene species, to which he unfortunately added the *Angræcum sesquipedale*, Thou., notwithstanding the very great difference in the structure and form of the flowers, relying solely on some similarity in the pollinarium. Thouars very well distinguished them, placing the true *Aeranthi* with their prominent mentum and spurless labellum in *Dendrobium*, and the long-spurred *sesquipedale* in *Angræcum*. Reichenbach, by including Lindley's *Mystacidium*, *Ætonia*, and others in *Aeranthus*, still further invalidated the genus, which I would again reduce to the two original species. *Aerides*, Lour., of which we know about fifteen species, chiefly Indo-Malayan, with one from Japan, combines the mentum of the second series with a spur nearly that of the third, but usually turned upwards on the back of the labellum. It is often more or less confounded with *Saccolabium*, which has usually, but not always, smaller flowers, no mentum, but a descending spur or sack close to the base of the labellum, and several still more different species have been added to it. Thus *Aerides appendiculatum*, Wall., is a *Cleisostoma*, *A. hystrix* and *A. difformis*, Lindl., form the genus *Ornithochilus*, *A. tæniæle*, Lindl., is a *Doritis*, *A. Wightianum*, Lindl., is *Vanda parviflora*, Lindl. *A. multiflorum*, Roxb. (*A. affine*, Lindl.), has the habit of *Aerides* and *Saccolabium*, with the perianth of *Arachnanthe* (*Armadorum*),

and certainly appears to connect these genera. The pollinarium affords no marked character to distinguish them.

Series 3. *Columna sæpissime apoda. Labellum basi calcaratum.*—I would here include sixteen Old-World and two American genera. *Renanthera*, Lour. (*Nephranthera*, Hassk.), five Indo-Malayan species, has the very spreading perianth of *Vanda*; but the lateral sepals are usually longer and closely parallel or united under the labellum, especially in the typical *R. coccinea*, Lour., and *R. matutina*, Bl. In *R. micrantha*, Bl. (*R. elongata* and *R. matutina*, or *Saccolabium reflexum*, Lindl.), and two or three allied species, the character is less marked, but sufficient to retain them in the genus, with which they agree in other respects. *Vanda*, Br., as now limited, has about twenty Indo-Malayan species, one of them extending to Australia. Among the excluded species, Blume's section *Fieldia* now forms the above-mentioned genus *Stauropsis*; and *V. densiflora*, Lindl., his section *Anota*, must be restored to *Saccolabium*, in which genus it was already known as *Saccolabium giganteum*, Lindl. *Saccolabium*, Blume (a name needlessly altered by the author to *Saccochilus*), including *Robiquetia*, Gaudich., *Ceratochilus*, Blume, *Gastrochilus*, Don, and probably also *Omoea*, Blume, but excluding *Rhynchostyles* and *Ornithochilus*, becomes a fairly natural and well-characterized genus of about twenty species from the Indo-Malayan region. We have distributed them into six series, chiefly from the form of the perianth, and especially of the labellum. *Ceocclades*, Lindl., has also been rightly referred by Reichenbach to *Saccolabium*, as to most of the species. *C. tenera*, Wight, appears to be specifically identical with *Saccolabium brevifolium*, Lindl. *C. maculata*, Lindl., is referred by Reichenbach to *Eulophia*. *C. falcata*, Lindl., is an *Angræcum*. *Saccolabium filiforme* and *S. roseum*, Lindl., have been figured by Wight as species of *Sarcanthus*, and confounded by Thwaites with *Schænorchis juncifolia*, Blume, of which they have the habit, but they have all the characters of true *Saccolabium*; *Saccolabium acuminatum*, Thw., is, however, a true *Sarcanthus*, and specifically the same as *S. peninsulare*, Lindl. *Saccolabium Hillii*, F. Muell., is rather an *Ornithochilus*. *S. densiflorum*, Lindl., referred by Reichenbach to *Sarcanthus*, appears to me to be a *Cleisostoma*. *S. lineolatum*, Thw., is *Cleisostoma maculosum*, Lindl.

Uncifera, Lindl., two Khasiya species, *Acampe*, Lindl., eight

Asiatic and one African species, and *Sarcanthus*, Lindl., about fifteen Indo-Malayan species, require no further comment. *Cleisostoma*, Blume (in which Reichenbach includes *Pomatocalyx*, Lpa
v. Breda), has about fifteen species from the Indo-Australian region, excluding *C. tridentatum*, Lindl., already referred by Reichenbach to *Sarcochilus*; and *C. ionosmum*, Lindl., has also the characters of the latter genus. *C. maculosum*, Thw., appears to be a new species, the true *C. maculosum*, Lindl., having been, as above mentioned, described by Thwaites as a *Saccolabium*. *Echioglossum*, Blume, is distinguished by the author as having a linear bifid appendage to the labellum; the appendage is, however, certainly wanting in the specimens in herb. Lindl. of *E. muticum*, Reichb. f., and some others, which are evidently all true species of *Cleisostoma*. *Schænorchis*, Blume, limited to his first section, is a single, apparently very distinct, Javan species. *Ornithochilus*, Wall., has two Himalayan or Burmese species, regarded by Lindley as a section of *Aerides*, but in many respects coming nearer to *Saccolabium*, and connecting our second and third series of the subtribe Sarcantheæ; and the connection is still further established by the *Saccolabium Hillii*, F. Muell., from Australia, which we would add as a third species to *Ornithochilus*. *Teniophyllum*, Blume, has about six species, dispersed over the Indo-Australian and South-Pacific regions, some of them insufficiently known, from the great difficulty in examining their minute flowers, often very few on the specimens. *Microsaccus*, Blume, three or four Malayan species, might perhaps include *Adenoncos*, Blume, a small plant very imperfectly known, and which I have not seen. *Diploctrum*, Lindl., two or three Indian-Peninsular species, is remarkable for the double spur of the labellum.

Angræcum, Thou., taken in the extended sense given to it by the authors, would now comprise above fifty African and Mascarene species, connected chiefly by the long, often slender spur of the labellum. Great apparent differences, however, in the stipes and gland of the pollinarium have induced the breaking it up into several genera, of which some have proved to be very far from natural; but the following four may be fairly admitted. *Angræcum* would be limited to about twenty-five species. It has the stipes of the pollinarium flat, single or double, the flowers, with few exceptions, large, the spur often very long, but variable, and may be divided into three sections:—1. *Macroura*,

with a flat, often very broad lamina to the labellum, and the pollen-masses affixed to the surface of distinct flat stipites, the scale-like glands also quite distinct. This would include *A. sesquipedale* and *A. gladiifolium* of Thouars, and *A. funale*, Bot. Mag. 2. *Listrostachys*, Reichb., in which the lamina of the labellum is usually continuous with the spur, more or less concave at the base, and tapering into a point, the pollen-masses attached to distinct flat stipites, the glands or scales of the pollinarium also distinct or more or less united. 3. *Angræcum* proper, with the flat lamina to the labellum of *Macroura*; but the stipes of the pollinarium often narrow, though flat, single and entire, but often readily divisible into two, and sometimes perhaps naturally bifid. The species appear to be numerous, and to a certain degree polymorphous; in several, however, the pollinarium is imperfectly known. Reichenbach has proposed a genus *Aerangis* for an Angola species with an exceedingly long spur, in all respects a true *Angræcum* of this section, except that the stipes of the pollinarium is divided to about the middle. *A. caudatum*, Lindl., has an exceedingly long spur and the column exceptionally long. *A. infundibulare*, Lindl., is remarkable for the long funnel-shaped spur; *A. armeniacum*, Lindl., for its unusually small flowers; and to the African and Mascarene species must be added, notwithstanding its widely distant geographical position, the *Œceoclades falcata*, Lindl., from China and Japan, well figured by Thunberg as a *Limodorum*, as well as in Bot. Reg. t. 283 and Bot. Mag. t. 2097, but with all the characters of an *Angræcum* of the typical section. Miquel unfortunately referred it to *Aerides*, which led Franchet and Savatier to confound it with the *Aerides japonica*, Lindl., a true *Aerides*, which has not the slightest similarity with *Angræcum falcatum* in habit or character. *Cryptopus*, Lindl. (*Beclardia*, A. Rich., in part), is a single Mascarene species, with remarkable lobed petals and a peculiar pollinarium. *Æonia*, Lindl., has four or five Mascarene species, with the pollinarium of *Mystacidium* and a peculiarly shaped perianth, which induced Thouars to describe them under *Epidendrum*. *Mystacidium*, Lindl., comprises about twenty species, with the flowers usually much smaller than in *Angræcum*, and the pollen-masses affixed to distinct filiform stipites, either exceedingly short or long, and often clavate or cup-shaped under the masses. There is, however, here, as in *Angræcum*, a considerable variety in habit as in the structure of the flowers.

Thus *Gussonia*, A. Rich., and *Microcælia*, Lindl., both closely allied to if not varieties of *Angræcum aphyllum*, Thou., are leafless at the time of flowering. *A. caulescens*, Thou., and five or six allied species, may be sectionally distinguished in *Mystacidium* under the name of *Gomphocentrum*, by the spur of the labellum clavate at the end or broadly saccate, their long leaves are rigid as well as the stem, and the stipites of the pollinarium filiform at the base are clavate under the masses. *A. pellucidum*, Lindl. has a similar habit and pollinarium, but the spur is acute. Another very distinct section of *Mystacidium* would consist of *A. pectinatum*, Thou., and *A. distichum*, Lindl., two small species with numerous small distichous leaves, the lateral flowers usually solitary and almost sessile, and the stipites of the pollinarium so short as to make the pollen-masses appear sessile on the gland or scale, but the connecting viscum readily extensible into elastic threads. Reichenbach unites the whole genus *Mystacidium* with Lindley's *Aeranthus*, in which, however, I find it impossible to concur.

There remain two American genera, *Dendrophylax*, Reichb. f., three West-Indian aphyllous species (two of which Reichenbach classes as "*Aeranthi aphylli grandiflori*"), and *Todaroa*, A. Rich., about fifteen very small-flowered species dispersed over tropical America, and united by Reichenbach with *Aeranthus*. Both genera, however, appear to me to be sufficiently distinguished from their African allies by the form of the perianth and some other minor characters. *Todaroa*, however, cannot retain that name, as it was preoccupied in Umbelliferæ. I should propose to replace it by *Campylocentrum*.

Subtribe 8. NOTYLIEÆ.—This subtribe differs from all other Vandææ in the rostellum, which is erect at the top of the column or slightly inclined forward, as in many Neottieæ (*Spirantheæ*), and at the same time usually grooved or concave at the back, half embracing the closely appressed erect anther; the stigma in front of the rostellum, usually on a level with the base of the anther, is often nearly horizontal. The habit is in most cases that of the smaller Oncidieæ, the short stems ending in unifoliate pseudobulbs; but in two or three genera there are no pseudobulbs, but the stems are covered with short distichous leaves, as in *Dichæa* or *Lockhartia*, or their allies, and in one genus the leaves of the pseudobulbs are plicate. The pollinarium has one or two long stipites, descending from a small gland at the end of the rostellum, and usually linear or shortly dilated at the end. In

four of the genera the pollen-masses are quite like the ordinary ones of Vandææ, two either entire or more or less divided into two closely appressed portions; in three genera the four pollen-masses are quite distinct, and two genera, *Appendicula* and *Thelasis*, are exceptional in the whole tribe as having eight distinct pollen-masses.

These nine genera are distinct enough to have been generally admitted without hesitation, and require but little comment. Five are from tropical America:—*Cirrhaea*, Lindl. (*Scleropteris*, Scheidw.), five species; *Macradenia*, Br. (*Rhynchadenia*, A. Rich.), one or two species; *Notylia*, Lindl., about fifteen species; *Telipogon*, H. B. & K., about three species; and *Trichoceros*, H. B. & K., six or seven species, including *Telipogon astroGLOSSUS*, Reichb. f., which Lindley, in his herbarium, has rightly referred to *Trichoceros*. Four genera are Asiatic:—*Acriopsis*, Reinw., three or four species; *Podochilus*, Blume, about ten species, including *Cryptoglottis*, Blume (*Hexameria*, R. Br.), *Platysma* (afterwards *Plocostigma*), Blume, and *Apista*, Blume; *Appendicula*, Blume, about twenty species, including *Metachilum*, Lindl., and *Conchochilus*, Hassk., to which must also be added the *Epidendrum hexandrum*, Kœn., well described in Retz's 'Observationes,' but neglected by subsequent orchidologists (this species, represented in the Kew herbarium by an indifferent specimen from Rottler's herbarium, closely connects *Appendicula* with *Podochilus* through Brown's *Hexameria*); and, lastly, *Thelasis*, Blume (*Oxyanthera*, Brongn., *Euproboscis*, Griff.), eight nearly allied species or marked varieties.

Tribe 3. NEOTTIÆ.

Under this name I have united Lindley's tribes of Arethuseæ and Neotteæ, the supposed distinctive characters of which have proved far too uncertain to be relied upon, when each one had genera more nearly allied in their vegetative characters to corresponding ones in the other than to any of their own tribe. I have therefore here collected all the genera in which the general structure of the anther is that of the Epidendrææ or of some Vandææ, but with the pollen granular not waxy. The Neottieæ thus constituted are never pseudobulbous, and, with the exception of the small subtribe Vanilleæ, they are all terrestrial. The single anther is either incumbent and lid-like or erect behind the rostellum, and is always perfectly two-celled. The pollen is either

very finely granular and mealy, and then sometimes at one period with the granules so closely pressed together as to make it appear waxy, or with coarse compound granules often regularly packed in close rows, when it is termed sectile. It usually forms two masses in each cell, or one deeply furrowed mass; but the granules are often so loosely attached that it is very difficult to distinguish the masses except in a fresh state, and in some cases the granules of each cell are but very slightly and irregularly connected by the thin viscum. There are a very few genera, either among the Neottieæ of the subtribe Diureæ or among Epidendreæ of the subtribe Bletieæ, where the granular and waxy pollen may appear to pass from the one to the other, but when examined at the proper stage of development there does not appear to be any really close connection between the two tribes. The greater proportion of the Neottieæ are tropical; but there are a few species of the subtribes Spirantheæ, Arethuseæ, and Limodoreæ in temperate regions of the northern hemisphere, a considerable number of the subtribe Diurideæ in extratropical Australia, and two genera of Limodoreæ are extratropical in South America.

Of the six subtribes here proposed, the first two are so strongly marked in their vegetative characters that they might almost have been united in a separate tribe, but that their structural characters are not of a very high order, and not the same in the two. The other four are much less definite in habit, and not always distinctly marked in character, but have appeared to me more natural than the ten proposed in Lindley's 'Vegetable Kingdom,' of which, moreover, no characters are given.

Subtribe 1. VANILLEÆ.—Of this and the following subtribes the stems are tall, sometimes branched or with branched or at once axillary and terminal inflorescences, and the leaves usually larger, more coriaceous, or plicately ribbed than in the other subtribes. The distinction between the two lies chiefly in that the anther in Vanilleæ is incumbent over the short rostellum, with the pollen, as in Epidendreæ, not affixed to any gland or stipes detachable from the rostellum; whilst in Corymbeæ the anther is erect behind the erect rostellum, and the pollen is, after dehiscence, affixed to a stipes descending from a detachable gland, forming a pollinarium analogous to that of Vandææ. The Vanilleæ comprise five genera, of which two (*Galeola* and *Vanilla*) are branching epiphytes, ascending sometimes to the tops of the tallest trees, and three (*Sobralia*, *Epistephium*, and *Sertifera*) are

terrestrial and American, tall and erect, with more or less plicate or strongly ribbed leaves. *Galeola*, Lour., about twelve species, should, I think, include *Cyrtosia*, Blume, *Erythorchis*, afterwards *Hæmatorchis*, Blume, *Pogochilus*, Falcon., *Ledgeria*, F. Muell., and *Eriaxis*, Reichb. f. These supposed genera have been distinguished chiefly by the fruit, which is fleshy, and said to be quite indehiscent in *G. javanica*, fleshy and splitting into valves only when very old in *G. Lindleyana* and *G. septentrionalis*, longer, more slender, and readily dehiscent in *G. altissima* and *G. cassythoides*. Most of the species are leafless; but in *G. (Ledgeria) foliata*, F. Muell., the scales subtending the branches of the inflorescence are enlarged almost into true leaves, and in a New-Caledonian species (*Eriaxis*, Reichb. f.), and possibly some others, real leaves are developed on a few barren branches. *Eriaxis* itself closely resembles in most respects *G. altissima*; but the capsule is said to split into six valves, which may be the normal number, though in other species they adhere variously into two, three, or four. The genus retained in entirety is an eminently natural one. *Vanilla*, Sw., has about twenty species nearly allied to, but perfectly distinct from *Galeola*, and dispersed over the tropical regions of both the New and the Old World. Though the majority of the species are leafy, there is one which, like *Galeola*, has no leaves. The fruit is usually indehiscent, but will sometimes when old split into valves.

Sobralia, Ruiz and Pav., about thirty species, ought probably to include *Fregea*, Reichb. f., a genus founded on a single dried specimen, and *Cyathoglottis*, Poepp. and Endl.; neither of them are, however, known to me, except from the published figures and descriptions. *Epistephium*, Kunth, about six species, is distinguished from *Sobralia* by the dentate apex of the ovary, a character which is of no more than specific value in the few instances where it has been observed in other genera; but here it is too constant through several species to be neglected, and appears to be accompanied by some other slight differences. *Sertifera* was established by Lindley in his herbarium on a well-marked, small-flowered species in Spruce's Ecuador collection, and taken up and characterized by Reichenbach, who has since added a second Peruvian species unknown to me, but which, from the character given, may possibly not prove to be a true congener.

Subtribe 2. CORYMBÆ.—The two genera *Corymbis* and *Tropidia*, with the floral structure of a few genera of Spiranthæ, have so totally different a habit and inflorescence that one feels

compelled to admit them as a distinct subtribe. They are tall, terrestrial plants, with plicate or strongly ribbed leaves, and are usually either branched or with branched or at once axillary and terminal inflorescences. *Corymbis*, Thou., six or seven species, is widely dispersed over the tropical regions of the New as well as the Old World. Not only have the Asiatic species published as *Hysteria*, Reinw., *Rhynchanthera*, Blume, and *Macrostyles*, v. Breda, proved to be strictly congeners, but the two American species of *Chloidia*, Lindl., show none but very slight specific differences in habit or character, the whole forming a very natural genus. *Tropidia*, Lindl., containing about five species from the Indo-Malayan and South-Pacific regions, is equally well characterized, if we include in it *Cnemidia*, Lindl., *Ptichochilus*, Schau., and *Govindovia*, Wight.

Subtribe 3. SPIRANTHÆ.—These are all terrestrial, with a creeping or short rhizome, not forming, as far as known, any underground tubers. The flowering-stems are erect, simple; with membranous leaves or very rarely leafless, and a simple terminal raceme sometimes condensed into a spike. The rostellum is terminal and erect or inclined forward, the anther behind the rostellum and parallel to it, the pollen-masses after dehiscence either suspended from or attached to the gland of the rostellum, or affixed to the end of a stipes descending from that gland. The thirty-five genera comprised in the subtribe may be distributed into two series, well indicated by Blume, but whose character may, in the case of some genera, require further investigation on living specimens, for the precise nature of the pollen is often very difficult to ascertain in the dried state.

Series 1. Genera either tropical American or extratropical in both worlds, with the exception of a very few species of *Spiranthes* itself in the tropical regions of the Old World, the pollen almost always finely granular or mealy. They include eight genera with the labellum superior—*Altensteinia*, *Pterichis*, *Cranichis*, *Prescottia*, *Wulfschlagelia*, *Pseudocentrum*, *Gomphichis*, and *Stenoptera*, all tropical American; and six with the labellum inferior or pendulous—*Neottia*, *Listera*, *Spiranthes*, *Ponthieva*, *Baskervilla*, and *Pelexia*, some of which have a more general geographical distribution.

Altensteinia, H. B. & K., about twelve species, should include *Aa* and *Myrosmodes*, Reichb. f., as appears to be admitted by the author (Xen. Orch. iii. 18). *Pterichis*, Lindl., including *Acraea*,

Lindl., about six species, though distinct in the form of the labellum and other slight characters, is yet very near to *Altensteinia*. *Cranichis*, Swartz, has nearly twenty species, to the exclusion of *C. parvilabris*, Lindl., which, according to our specimens, is a species of *Ponthieva*. *Cranichis*, should, however, include *Ocampoa*, A. Rich., referred in herb. Lindl. to *Prescottia*; but Lindley's analysis shows all the characters of *Cranichis*, except that the labellum is unguiculate. *Prescottia*, Lindl., is a well-marked genus of about twenty species, and includes *Decaisnea*, Brongn., and *Galeoglossum*, A. Rich. *Wulfschlagelia*, Reichb. f., is remarkable for the very slender leafless stems and minute flowers; these are allied in character to *Cranichis*, but with the lateral sepals united at the base into a mentum shortly and obtusely prominent in the type species, to which I would add as a second species Spruce's n. 2847, from the Rio Uaupés in North Brazil, as *W. calcarata*, with the diagnoses "perianthii mento longiuscule angustequae calcariformi, calcar labelli includente." *Pseudocentrum*, Lindl., three or four species, has the long spur-like mentum of *Wulfschlagelia calcarata*, formed by the base of the lateral sepals; but the linear portion of the labellum inside is not a basal spur, but the grooved linear lamina itself, only very shortly closed and inflected at the end. *Gomphichis*, Lindl., four or five species, was at one time united by Reichenbach with *Stenoptera*, but again admitted by him as distinct (Xen. Orch. iii. 20). *Stenoptera*, Presl, three species, should, however, include *Porphyrostachys*, Reichb. f.

Neottia, Linn., is now generally limited to the two or three European or North-Asiatic leafless species, of which *N. Nidus-avis* is the type. Amongst them *N. Lindleyana*, Dcne., appears to be but a slight variety of *N. listeroides*, Lindl., and *N. micrantha*, Lindl., is a very doubtful congener. It was only described from a single specimen received by Lindley from Prescott labelled as from Siberia, and was quite unknown to Ledebour and all other writers on the Russian flora. *Listera*, R. Br., has about ten well-known species from Europe, temperate Asia, and North America. *Spiranthes*, L. C. Rich., now comprises at least eighty species, and extends over the tropical as well as the temperate regions of both the New and the Old World. It had been previously indicated by Persoon as a section of *Neottia* rather than as a genus under the name of *Gyrostachys*, and proposed as a genus by Salisbury as *Ibidium*, but without any character, and by

Loureiro under the preoccupied name *Aristotelea*. Richard's name, the first well-established and properly characterized one, has therefore been rightly adopted by all except perhaps by Blume, who unfortunately took up Persoon's; *Cyclopogon*, Presl, is also the same genus. The species vary much in foliage, and especially in the size of the flower, and have been distributed into several genera, although different authors have assigned different limits to each. I would propose the following four sections as the most natural:—1. *Spiranthes* proper, comprising a large number of the best-known North-American, European, and Asiatic species with usually narrow leaves and small flowers in a spiral line round the axis of the spike, the lateral sepals obliquely attached to the apex of the ovary, or only very shortly decurrent. 2. *Sauroglossum*, the radical leaves petiolate and ovate or ovate-lanceolate, the loose spike scarcely unilateral, with the flowers usually larger than in *Euspiranthes*, the lateral sepals less obliquely attached and not decurrent. The species are few and all tropical American, including the genera *Sauroglossum* and *Synassa* of Lindley, also the *Spiranthes elata*, A. Rich., which, however, is specifically distinct from *Sauroglossum elatum*, Lindl. 3. *Sarcoglottis*, with the foliage and inflorescence of *Sauroglossum*, but the flowers usually larger, the lateral sepals with the base of the column decurrent on the ovary, but not forming a prominent mentum. The species are few, all tropical American, including the genus *Sarcoglottis*, Presl. 4. *Stenorhynchus*: tall plants, the radical leaves usually narrowed at the base, the spike dense with large flowers, the lateral sepals with the base of the column decurrent far down the ovary, forming a distinctly prominent mentum. The species are all American, tropical or subtropical, and include, besides those usually referred to the genus *Stenorhynchus*, L. C. Rich., the *Spiranthes hirta* and *S. bonariensis*, Lindl., and a few others. *Ponthieva*, R. Br., about ten American species, requires no comment. *Baskervilla*, Lindl., a single Peruvian species, has a very singular rostellum, and the pollen-masses appear solid, and are produced into long caudicles; yet the place of the genus seems clearly to be among the *Spirantheæ*; the analysis sketched in herb. Lindl. has proved not to be quite correct. *Pelexia*, Lindl., first published by him as *Colleus*, should be limited to the seven or eight species with a long, spur-shaped basal projection of the lateral sepals. The name *Pelexia* was originally Poiteau's, mentioned by L. C. Richard as a genus,

but without giving any character, and it included the *Spiranthes adnata*. Sprengel further extended it to the very different Japanese spurred species of *Cephalanthera*.

Series 2. The twenty-one genera of this series are, with the exception of a few series of *Goodyera* and *Physurus*, all tropical and limited to the Old World. The pollen is generally if not universally sectile, and most frequently the odd sepal and the petals are connivent in a galea over the column. They have for the most part been so admirably illustrated by Blume as to require but few observations beyond the bare enumeration under the following heads, in the order which we propose to adopt for the 'Genera Plantarum.'

1. *Labellum with a pouch or spur at the base, prominent between the lateral sepals.*—*Physurus*, L. C. Rich. (*Erythrodes*, Blume, and *Microchilus*, Presl), has about twenty species, all tropical, but American as well as Asiatic, and should, I think, include as a section *Queteletia*, Blume (*Orchipedium*, V. Breda), chiefly distinguished by the forward inclination of the perianth; the American species do not appear to afford any general character to separate them from the Asiatic ones, although the nature of their pollen may require further investigation. *P. glandulosus*, Lindl., is a *Cystorchis*. *Anæctochilus*, Blume, including *Chryso-baphus*, Wall., has about eight Indo-Malayan species, to the exclusion of *A. lanceolatus*, *A. grandiflorus*, and *A. flavus*, Lindl., *A. Jauberti*, Gaudich., and *A. longiflorus*, Reichb. f., which all belong to *Odontochilus*. *A. albolineatus*, Reichb. f., appears to be identical with *A. brevilabris*, Lindl. *Vrydagzenia*, Blume, has eight known species from the Malayan and South-Pacific regions, and includes *Anæctochilus sandwicensis*, Lindl. In *Cystorchis* Blume, the two typical species from the Archipelago have two large vesicles at the base of the labellum, which are said to be wanting in *C. obscura*, Blume, and are certainly deficient in *Ætheria fusca*, Lindl., from the Himalaya, which has all the other characters as well as the habit of *Cystorchis* and not of *Heteria*. *Herpysma*, Lindl., is a single Himalayan species, remarkable for the long spur of the labellum, and the long rigid caudicles of the pollen-masses; the habit of the plant closely resembles that of *Myrmechis*.

2. *Labellum spurless, or the short protuberance included in the base of the lateral sepals.*—In the first two of the following genera the pollen-masses are affixed to a long stipes descending from the

gland of the rostellum, in all the others they or their caudicles are sessile on the gland. *Zeuxine*, Lindl., about sixteen species from the Indo-Malayan region, includes *Adenostylis*, Blume, a name preoccupied in Compositæ, *Tripleura*, Lindl., and *Psychechilus*, V. Breda. It has been well divided by Blume into three sections, *Zeuxine* proper, *Lathrodes*, and *Psychechilus*, to which I would add, as a fourth, *Monochilus*, Wall. (*Haplochilus*, Endl.), distinguished chiefly by the rather larger flowers and the habit approaching that of *Goodyera*. *Cheirostyles*, Blume, well characterized by the perianth and the column, has about eight species from the same Indo-Malayan region. *Odontochilus*, Blume, from the Indo-Malayan and South-Pacific regions, should include about ten species; for, as far as can be judged from Blume's plates and from dried specimens, I can find no sufficient character to separate *Cystopus*, Blume. The genus comes very near to *Anæctochilus*, both in habit and character, but the labellum has no spur. *Myrmechis*, Blume, has two Javan species, *M. gracilis* and *M. glabra*, Blume, which are identical with *Rhamphidia alsinæfolia* and *R. grandiflora*, Lindl., respectively; they have a peculiar habit, and are much nearer allied to *Odontochilus* than to *Hæteria*, to which belong the typical species of *Rhamphidia*. *Hæmaria*, Lindl., previously indicated by A. Richard, but not satisfactorily published, under the name of *Ludisia*, extends from the Malayan archipelago to China in four species, including *Myoda*, Lindl. *Dossinia*, Morr., is a single well-known species, said to have been introduced into our gardens from Borneo; the Khasiya plant referred to it by Lindley appears to me to be different; but I have only seen a single specimen, which I could not examine. *Macodes*, Blume, and *Hylophila*, Lindl., are both monotypes from the Malayan Archipelago. *Goodyera*, R. Br., is a genus of about twenty-five species, spread over Europe, tropical and temperate Asia, and North America, with perhaps a single (unpublished?) tropical-American species; for *G. guianensis*, Lindl., is *Spiranthes Hostmanni*, Reichb. f., and *G. Wrightii*, Reichb. f., is also a *Spiranthes* of the section *Stauroglossum*. Blume appropriately united with *Goodyera* as a section Lindley's genus *Georchis*, distinguished chiefly by the form of the pollinary apparatus, but running much into *Goodyera* proper; he also proposed as a third section, under the name of *Cænorchis*, the *G. pusilla*, Blume, with a long caudicle to the pollen-masses. One would also be tempted to make a distinct section for the *G. procera*, Hook. (*Cionisaccus*, v. Breda, *Cordylestylis*, Falcon., *Leucostachys*, Hoffmans.), a tall, leafy

Asiatic species, with which might be associated in the same section *G. fumata*, Thw., from Ceylon, and *G. macrophylla*, Lowe, from Madeira. *Lepidogyne*, Blume, a single Japanese species, is only known to me from Blume's figure and description. *Heteria*, Blume, variously spelt *Etæria* and *Ætheria*, is a fairly natural genus of about ten species, from the Indo-Australian and South-Pacific regions. The original small-flowered species of Blume were also the types of Lindley's genus *Rhamphidia*, and the larger-flowered species forming Lindley's *Cerochilus* and *Rhomboda* appear to be strictly congeners; nor can I find any adequate character to separate generically Reichenbach's *Salacistis*, which, however, I only know from his figure and description. *Mærenhoutia*, Blume, is a single species from the Society Islands, nearly allied to *Heteria*, with which it is perhaps too closely connected through an unpublished species from Niviti-Levu. *Platylepis*, A. Rich., is a distinct genus of four or five species, from the Mascarene Islands and tropical and South Africa, including *Diplogastra angolensis*, Welw., which appears to me to be specifically identical with *Notiophrys glandulosa*, Lindl. But *Notiophrys Commelynæ*, Lindl., from Taiti, is *Mærenhoutia plantaginea*, Blume; and *Platylepis heteromorpha*, Reichb., from Upolu, in the South Pacific, may possibly be another *Mærenhoutia*; but I have seen no specimen. *Eucosia*, Blume, is only known from a single Javan specimen, which I have not seen. *Gymnochilus*, Blume, two Mascarene species, is scarcely distinct from *Goodyera*, except in the labellum being uniform with the petals. *Argyrorchis*, Blume, a single Javan species, is said to be only distinguishable from *Macodes* by the same uniformity of the labellum with the petals. This character, in the case of a few genera where it has been observed, especially *Paxtonia* and *Uropedium*, has been attributed to an abnormal peloria condition, whilst in *Thelymitra* it is a marked generic distinction, pervading through several species. It requires, therefore, further investigation in the case of *Gymnochilus* and *Argyrorchis*.

Subtribe 4. DIURIDÆ.—The great majority of this subtribe are Australian genera, approaching *Arethuseæ* in their vegetative characters and *Spirantheæ* in their erect anther; but I have felt compelled to commence the series with three small Asiatic genera which require further study, which we have not at present the means of carrying out. These are *Lecanorchis*, Blume, one Japanese and one Javan species; *Aphyllorchis*, Blume, about five

species from the Indo-Malayan region; and *Stereosandra*, Blume, one Javan species. They have all slender, erect, leafless, simple stems arising from a tuberous or branching rhizome, and bear a loose, simple spike or raceme of rather small flowers. *Lecanorchis* is remarkable for the appendage crowning the ovary, like that of *Epistephium*. *Aphyllorchis* has been rightly shown by Reichenbach to include the Ceylon plant which Thwaites had mistaken for *Apaturia montana*, Lindl. *Stereosandra* is compared by Blume with *Epipogon*; but the anther figured is very different, and would bring it much nearer to *Aphyllorchis*.

The genuine Australasian genera of Diurideæ, twenty-one in number, have so recently been worked up in the 'Flora Australiensis,' and so admirably illustrated with several interesting additions by Fitzgerald in his 'Australian Orchids,' that I have no remarks to add on the present occasion with regard to their respective delimitation. Their rhizome is, with few exceptions, more or less tuberiferous, producing simple erect stems, sometimes leafless, at least at the time of flowering, more frequently bearing a single one or two, very rarely more leaves, the spike or raceme simple and terminal. The anther is erect or leaning forwards, and frequently persistent; the rostellum is terminal and erect, but often exceedingly short, rarely as long as the anther; the pollen powdery-granular, sometimes so compact as to appear solid. The twenty-one genera are all Australian; for *Adenochilus*, which was supposed to be limited to New Zealand, has recently had a genuine Australian species added to it by Fitzgerald. Twelve of them are represented in New Zealand, three in New Caledonia, and three (*Thelymitra*, *Coryanthes*, and *Cryptostylis*) extend to the Malayan archipelago, and the last-mentioned genus to East India; but these extra-Australasian species are but very few, and generally closely allied to Australian ones, suggesting for the whole group an Australian origin.

Subtribe 5. ARETHUSEÆ.—Lindley's tribe of Arethuseæ, as originally laid out and since variously extended, has been made to include genera very dissimilar in vegetative and even in structural characters, and even limited, as we should propose, to a subtribe of Neottieæ, and is not so distinctly marked out as could be wished. It is chiefly characterized as distinct from Diurideæ by the more or less incumbent anther and the short rostellum, sometimes quite obsolete, sometimes slightly projecting horizontally above the stigma, which is on the face of the column, either close under the

rostellum or at a distance from it. The rhizome is generally more or less tuberiferous, producing simple erect flowering-stems, either leafless or with a single leaf, the leaves usually arising separately from the rhizome or sometimes entirely wanting: it is only in a few species of *Pogonia* that the flowering-stem bears two to four leaves; the raceme or spike is always simple and terminal. The geographical distribution is extensive, a considerable proportion of the species being dispersed over the temperate regions of the northern hemisphere, some with a wide specific area; some also are tropical, either in the New or the Old World; beyond the tropics in the southern hemisphere they are very rare, only two species being known in extratropical Australia and one in extratropical South America, none in South Africa.

The eight following genera are the only ones we would include in the subtribe. *Arethusa*, Linn., has three species, one from Japan and one from North America, to which we would add as a third the *Crybe*, Lindl., from Guatemala, which, with precisely the same floral structure, differs in the tardy development of two or three leaves from a bud of the rhizome separate from the flowering scape. *Calopogon*, R. Br., contains three or four closely allied species from North America and the West Indies, Wright's no. 3317, from Cuba, being but slightly distinct from the common *C. pulchellus*. *Pogonia*, Juss., as extended by Blume and by Reichenbach, comprises about thirty species, closely connected in their floral structure, but capable of being distributed into five sections, so well marked out by vegetative characters as to have been plausibly regarded by some as so many distinct genera. These are:—1. *Nervilia*, Gaudich., including *Cordyla*, afterwards *Rophostemon*, Blume, and *Aplostellis*, Thou., about fifteen tropical or subtropical Old-World species; 2. *Pogonia* proper, two North-American species, of which one is also in Japan; 3. *Cleistes*, L. C. Rich., of which eleven species have been published, but several of them not really distinct, all from tropical America; 4. *Triphora*, Nutt., about eight American species, northern or tropical; 5. *Codonorchis*, Lindl., two American extratropical species, one northern, the other southern. *Chlorosa*, Blume, a single Javan species, is only known to me from the author's figure and description; he compares it with *Cryptostegia*, but the characters given appear to me to bring it much nearer to *Pogonia*. *Leucorchis*, Blume, two or three species from the Indo-Australian and South-Pacific regions, includes *Apetalon*, Wight, and *Epiphanes*, Reichb. f.

Gastrodia, R. Br., about seven species from the Indo-Australian region, extending to New Zealand, includes *Epiphanes*, Blume, and *Gamoplexis*, Falcon. (whose analysis in the Linnean Transactions, xx. t. 13, is not quite correct). *Yoania*, Maxem., is a single Japanese species, unknown to me; but, from the character given, it must be allied to *Epipogum*. *Epipogum*, Gærtm., consists of two species, both of them remarkable for the wide area over which they are scattered in few individuals, the one in Europe and temperate Asia, the other in tropical Asia, Africa, and Australia; the latter species constitutes the genera *Galera*, Blume, *Ceratopsis*, Lindl., and *Podanthera*, Wight.

Subtribe 6. LIMODOREÆ.—The genera here collected have the more or less incumbent anther and short rostellum of Arethuseæ, but differ considerably in habit. They never form underground tubers; the erect, simple stems, except in a very few species, bear several leaves; they are usually tall, with a simple terminal spike or raceme. They are all extratropical, either in the northern hemisphere generally, or limited to extratropical South America.

Five genera now belong to the subtribe, all well known, and now of undisputed delimitation. *Limodorum*, as limited by L. C. Richard to a single Mediterranean species, for the *Limodorum* of older authors was an amalgamation of dissimilar plants since dispersed in different genera. *Chloræa*, Lindl., about eighty extratropical South-American and chiefly Chilian species, includes *Asarca*, Lindl., which it has been vainly attempted to distinguish generically, sometimes by one character, sometimes by another. *Bieneria*, Reichb. f., a supposed intermediate genus, and *Ulantha* Hook., published in Bot. Mag. t. 2956, as a West-Indian plant, but since shown to be a Chilian *Chloræa*, cultivated in the St. Vincent botanic garden. *Bipinnula*, Juss., has two or three extratropical South-American species, only distinguished from *Chloræa* by the very remarkable pinnatifid petals. *Cephalanthera*, ten northern species from the New or the Old World, amongst which two from North-west America, published as *Chloræas*, and one from Japan, are occasionally leafless or nearly so. *Epipactis*, Crantz, ten species, also northern, from the New or the Old World.

Tribe 4. OPHRYDEÆ.

The Ophrydeæ, as established by Lindley, form a perfectly distinct tribe, circumscribed by positive characters derived from

the anther, to which there is no exception, nor are any intermediate forms known connecting it with other tribes. The anther, erect above the rostellum or turned back away from it, is adnate to the top of the column; the anther-case or connectivum perfectly continuous with the clinandrium, not showing any line of demarcation between the two, except, perhaps, a very faint one in two or three species; the two raised adnate cells are quite distinct, parallel or divergent, and tapering at the base, so as to appear in a reversed position; they vary from very short to much prolonged at the base, when their tapering ends are adnate to or applied upon the apex of the column, and thence frequently on to the lobes of the rostellum, with their back and not their dehiscent fronts regarding the rostellum. The pollen is usually coarsely granular, rarely fine and almost mealy, forming in each cell one or rarely two masses, produced into the tapering base of each cell in a smooth caudicle, which at or beyond or sometimes shortly within the end of the cell becomes affixed to a gland, in most cases, and perhaps always, detached from the rostellum. In the three preceding tribes it is the dehiscent face of the anther-cells and not their backs which is incumbent on or applied against the rostellum, and the pollen-masses taper into points or caudicles at the upper, not the lower, end, or, when obtuse, become affixed to the gland at various points on their surface, never through a basal caudicle. The only approach in the position of the anther to that characterizing the Ophrydeæ observable in any other tribe is in the few genera of the subtribe Microstyleæ, where the anther is sessile on its back diverging from the rostellum, and is sometimes persistent, but always perfectly distinct from the top of the column, never continuous with it. These differences between the anther of Ophrydeæ and that of the other tribes may be said to be that it is adnate or innate in the former, versatile in the latter. In general habit the Ophrydeæ are all terrestrial, never pseudobulbous; the rhizome most frequently forms annually a distinct tuber, destined to produce the next year's stem, and placed by the side of or at some distance from the old one, which subsequently shrivels up and disappears. In a few species, however, the rhizome shortly creeps with rather fleshy fibres, as in many Neottieæ. The stem is simple, usually but not quite always leafy near the base or in its whole length, bears a simple terminal raceme or spike, and dies down after ripening its seed. By far the greater number of species are extratropical, northern in

Europe, Asia, Mediterranean Africa, and America, or southern in Africa. Very few small genera have any species in tropical Asia or Africa and none in America, except the large genus *Habenaria*, which, although it be, like the rest of the tribe, chiefly extratropical, has a few species scattered over the tropical regions both of the New and the Old World.

However well defined the whole tribe may be, the genera are often very much the reverse, and very difficult to distribute plausibly into subtribes. The following four, slightly modified from Lindley's six, are the best I have been able to devise.

Subtribe 1. *SERAPIADEÆ*.—Anther erect above the rostellum, the gland of the pollinarium single or double, enclosed in a single one or in two distinct pouches raised from the back of the rostellum. This subtribe comprises the four genera *Orchis*, *Serapias*, *Aceras*, and *Ophrys*. *Orchis*, Linn., now contains nearly eighty species, from Europe, temperate Asia, and Mediterranean Africa, with two somewhat anomalous ones from North America. They have all a spurred or pouched labellum, and the glands of their pollinarium are enclosed in a single pouch; the two glands usually distinct and either closely contiguous or quite separate, but in a few species they are more or less perfectly united into a single one. This character has induced the separation of these species into several distinct genera, which, however, have not been very generally adopted. Thus *Barlia*, Parl., is the *O. longibracteata*, Biv., which in habit and all other characters is a true *Orchis*. *Loroglossum*, L. C. Rich., comprises *O. hircina*, Linn., and two allied species, in which the long strap-shaped labellum has the basal spur reduced to a short pouch. *Comperia*, C. Koch, is *O. Comperiana*, Stev., in which the labellum has four long tail-like points. *Anacamptis*, L. C. Rich., is *O. pyramidalis*, Linn., and *Traunsteineria*; Reichb., is *O. globosa*, Linn., which in their habit seem to connect *Orchis* with *Habenaria*; and in *O. globosa* the glands of the pollinarium are said by some to be naked, as in *Habenaria*; but they certainly appear to me to be enclosed in a pouch, as in *Orchis*, though the pouch be of an exceedingly thin texture. The two North-American species, *O. spectabilis*, Linn., and *O. rotundifolia*, A. Gr., with a very different habit, are also near *Habenaria*, and, like some North-American species of that genus, have no underground tubers; but the pouch of the pollinarium is certainly that of *Orchis*, of which they might form a distinct section. *Serapias*, Linn., four or five species from the Mediter-

anean region, has the perianth usually so different in form from that of *Orchis*, that it is universally retained as a distinct genus; and yet there occur occasionally, especially in Italy, where *S. cordigera* and *S. longipetala* are abundant, a few individuals more or less intermediate between these and *Orchis longiflora* or *O. papilionacea*, which have been published as a species under the name of *Serapias triloba*, Viv., or as a genus as *Isias* of DeNotaris. These are believed by Grenier and Godron and some others to be hybrids, whilst others say that the circumstances under which they have been found do not justify the supposition. *Aceras*, R. Br., is now limited to the single *A. anthropophora*, R. Br., from the Mediterranean region and Western Europe, a species nearly allied to the section *Loroglossum* of *Orchis*, with which some botanists would unite it. *Ophrys*, Linn., the only genus with separate pouches for the two glands, is a very natural one, chiefly abundant in the Mediterranean region, but generally dispersed over Europe. The species, distinguished mostly by the shape and markings of the labellum, are very variable, and have been as variously estimated from under twenty to above thirty.

Subtribe 2. HABENARIÆ.—These are distinguished from *Serapiadæ* by the glands of the pollinarium being detached from the surface or end of the rostellum without any enclosing pouch, a character usually very plain; but there are some species in which the surface or end of the rostellum is slightly raised round the glands, so that they have been differently described as naked, half covered, or enclosed in a pouch. These species are, however, so very few as not materially to invalidate the subtribual character. For our 'Genera Plantarum' we have admitted into the subtribe thirteen genera, three with a spurless perianth (*Herminium*, *Stenoglottis*, and *Arnottia*), and ten with a more or less spurred labellum (*Bartholina*, *Huttonæa*, *Holothrix*, *Bicornella*, *Habenaria*, *Diplomeris*, *Bonatea*, *Cynorchis*, *Hemipilia*, and *Glossula*).

Herminium, R. Br., comprises about six European and Asiatic species, chiefly distinguished from the small-flowered *Habenariæ* by the want of the spur. It was originally founded on the *H. Monorchis*; but Lindley added to it a few others, including *H. alpinum* or *Chamorchis*, L. C. Rich., in which the front of the perianth or labellum is turned downwards instead of upwards, a character which varies in more than one Orchideous genus. We would also refer to *Herminium* the *Aceras angustifolia*, Lindl., proposed as a genus by Falconer under the name of *Thisbe*, and

apparently conspecific with the Japanese *Aceras longicuris*, C. Wright. *Aopla*, Lindl., is the *Herminium reniforme*, Wall., with a floral structure almost the same as that of *H. grandiflorum*, Lindl. *Stenoglottis*, Lindl., is a single South-African species differing but little from *Herminium*, but with a character requiring some slight modification from that given by Lindley. *Arnottia*, A. Rich., has two Mascarene species with the habit of *Cynorchis*, but with the floral structure nearer that of *Herminium* and *Stenoglottis*.

Bartholina, R. Br., is a single South-African species, distinguished as well by its unifoliate uniflorous stem as by its singular labellum and anther. *Huttonæa*, Harv., and *Hallachia*, Harv., are two South-African plants, evidently congeners, and readily known by the very exceptional form of their petals. *Holothrix*, Lindl., should, I think, include the same author's genera *Saccidium*, *Monotris*, *Bucculina*, *Scopularia*, and *Tryphia*; we should then have a very natural small-flowered genus with a peculiar habit, and characterized by the narrow petals and labellum all longer than the sepals. There are about eighteen species known, all African, two of them (as yet unpublished) Abyssinian, the others all southern. *Bicornella*, Lindl., contains two Mascarene species scarcely distinguished from *Habenaria* by two appendages starting from the base of the labellum and adnate to the sides of rostellum. *Habenaria*, Willd., is now a vast cosmopolitan, and in many respects polymorphous, genus, of which there are about 350 species in the Kew herbarium, and perhaps 50 more, already published, are not there represented. The differences observed in the anther-cells, in the stigma, and in various appendages to parts of the flower are so great, that numerous attempts have been made to dismember it; but the single characters assigned have all proved either so variable from species to species, or so little in accordance with any other distinction, that I feel compelled to reunite the proposed genera after the example of A. Gray and some other recent botanists, although I cannot go so far as to agree with Grenier and Godron in uniting the whole genus with *Orchis*. As it is, I have had to record no less than twenty-eight generic synonyms; and in proposing to distribute the species into the following ten sections I cannot but feel considerable doubts as to the definiteness of the characters assigned to some of them, these characters being often very difficult to ascertain in dried specimens, the only ones I have had to work upon. 1. *Gymnadenia*,

*L. This
in
repete
shen. &
be
done*

R. Br.: the typical species of this section are the common *Habenaria Conopsea* and *H. odoratissima* and their allies, to which we would add the *H. nigra*, R. Br., or *Nigritella*, L. C. Rich., an alpine species very similar in character, and known to hybridize with them with the greatest facility. 2. *Tinea*, Biv., or *Neotinea*, Reichb. f., is the *H. intacta*, Lindl., distinguished from *Gymnadenia* chiefly by the lateral processes of the stigma, which vary so much throughout the genus. 3. *Leucorchis*, C. H. F. Mey., or *Bicchia*, Parlat., is the European *H. albida*, R. Br., near to which might be placed the North-American *H. tridentata* and *H. nivea*. 4. *Perularia*, Lindl., two closely allied species, one North-American, the other North-Asiatic. 5. *Dercæmeria*, Reichb. f., is *H. aphylla*, R. Br., a curious little aphyllous Abyssinian, and perhaps Arabian, plant. 6. *Peristylus*, Blume (*Gennaria*, Parlat., *Benthamia*, A. Rich., and *Cybele*, Falcon.), comprises the European *H. cordata*, R. Br., and a considerable number of small-flowered African and Asiatic species. 7. *Cœloglossum*, Hartm., was founded on the European *H. viridis*, R. Br., and should probably include *Platanthera satyrioides*, Reichb. f. Lindley gave the name *Cœloglossum* (changed by Fries to *Lindblomia*) to a different group comprising five Asiatic small-flowered species which might be referred to *Peristylus*, but closely connect that section with *Platanthera*. *Chæradoplectrum*, J. C. Schau., is evidently, from his figure, the *Cœloglossum lacertiferum*, Lindl., transferred to *Habenaria* in the 'Flora Hongkongensis.' 8. *Phyllostachya*, a section I should propose for several rather large Asiatic species with one tropical-African one, distributed by various authors in the genera *Gymnadenia*, *Platanthera*, and *Habenaria*, and collected by Reichenbach under *Gymnadenia*, all more like the typical *Platantheræ* than the typical *Gymnadeniæ* in structure, and all remarkable from the leaves passing into large foliaceous bracts which give them a peculiar habit. Nearly allied to them is the East-Indian *H. lutea*, Wight, distinguished in the whole genus by the sepals and petals connivent into a globular perianth. 9 and 10, *Platanthera* and *Habenaria* proper, comprise the great mass of the genus which most botanists consider as being susceptible of distribution into two great groups; but the various characters assigned have broken down in detail, and it would require a much longer study than I have been able to give to them, especially from dried specimens, to ascertain the real value of several apparent distinctions. It would appear, however, that *Platanthera*

might be made to include the great majority of northern temperate species with the lateral processes of the stigmatic apparatus rarely much developed; and the more tropical species, with these processes usually, but variously, extended, would form the section *Euhabenaria*, the flowers in the former usually smaller than in the latter. *Platanthera rotundifolia*, Richards., a plant resembling in habit the *H. (Platanthera) obtusata*, Richards., which is also North-American, has been shown by A. Gray to be a true *Orchis*. Reichenbach refers also to *Orchis* Lindley's *Gymnadenia spathulata* and *G. Chusua* from East India, both of which have the habit of the *Habenaria obtusata* and the *Orchis rotundifolia*; but in our dried specimens I have failed to find the pouch of the rostellum which I have very distinctly seen in the specimens brought to me by A. Gray of *Orchis rotundifolia*. *Gymnadenia pinguicula*, Reichb. f., from East India, is evidently allied to these species, but remarkable in the genus for the large funnel-shaped spur of the labellum. The following, mostly monotypic, proposed genera must also now be included in *Habenaria*:—*Mecosa*, Blume, from Java, has already been referred by Lindley to *Platanthera*. *Centrochilus*, J. C. Schauer, from the figure and description, must be the same as *H. (Platanthera) tipuloides*, Lindl.; and *Ponerorchis*, Reichb. f., from Japan, appears from the figure and description to be closely allied to that species, if not a starved state of it. *Mitostigma*, Bl., from Japan, referred by Miquel to *Gymnadenia*, is one of the small-flowered *Habenariæ*. *Dissorhynchium*, J. C. Schauer, belongs to a series of tropical-Asiatic species which, with their long-stalked stigmatic appendages, approach the *Bonateæ*. *Bilabrella*, Lindl., two South-African species, belongs to the same set of *Bonatea*-like *Habenariæ*, one of them apparently the same as *Bonatea tetrapetala*, Lindl. *Ate*, Lindl., consists of two East-Indian species belonging to a series of *Habenariæ*, of which *H. Heyneana* may be considered as the type. *Barlæa*, Reichb. f. (different from *Barlia*, Parlat.), is a small-flowered tropical-African species, formerly referred by the author to *Stenoglottis*, but allied to *Habenaria attenuata*, Hook. f.; the habit is nearly that of *Tinea*, but the long parallel stigmatic processes are those of various *Habenariæ* belonging to other sections. *Macrocentrum*, Philippi, is a Chilean plant which I have not seen; but I find nothing in the detailed description to distinguish it from the most ordinary series of tropical *Habenariæ*. *Synmeria*, Grah., is an Indian-Peninsular plant,

first rightly described as a *Habenaria*, and afterwards generically separated on account of a slight cohesion of the petals with the dorsal sepal.

The stigmatic differences in *Habenaria* to which so much importance has been sometimes attached are often difficult to observe in dried specimens; but all the forms appear to be reducible to one type. The ordinary concave stigma under the rostellum is entire or more or less divided into two lobes, or is attached by two processes projecting on each side at the base of the rostellum. Sometimes the central stigma is evidently viscid and effectively stigmatic, whilst the lateral processes are reduced to dry tubercles sessile at the base of the rostellum; sometimes the central stigma remains perfect, whilst the lateral tubercular sessile processes have been shown to be equally capable of stigmatic action; whilst in a large number of species, especially amongst the tropical ones, the central stigma appears perfectly dry and ineffective or quite disappears, and the tubercular or papillose apices of the long processes are alone stigmatic; and between these extremes it has appeared to me that every intermediate can be observed. So also with regard to the anther-cells, the short parallel cells confined to the erect portion of the anthers of some *Gymnadeniæ* are most gradually connected with those of the *Bonatea*-like *Habenariæ*, in which their elongated bases are carried along the top of the column and up the erect lobes or sides of the rostellum even to a level with the apex of the anther. In a few species the glands of the pollinarium are, after dehiscence, half covered by the slightly dilated ends of the valves of the anther-cells, which has given rise to the proposed genera *Perularia* and *Deræmeria*, but is more or less observable in a few species belonging to other sections.

In the preceding genera of this subtribe the rostellum is usually flat, or nearly so, and narrow between the glands; but in the following five, which some authors have proposed to unite with *Habenaria*, the rostellum is dilated and raised between the pollinary glands or the lobes, either broad, convex, and almost helmet-shaped, or folded into a narrow much raised ridge. These genera are:—*Diplomeris*, Don (*Diplochilus*, Lindl.), two Himalayan species; *Bonatea*, Willd., three South-African species, perhaps reducible to two *B. speciosa*, Willd., *B. foliosa*, Lindl., and *B. Boltoni*, Harv.), the other supposed species of *Bonatea*, chiefly East-Indian, being truly referrible to *Habenaria*; *Cynor-*

chis, Thou., about twelve Mascarene and South-African species, including *Amphorchis*, Thou. (at least *A. calcarata*, Thou., which is *Cynorchis squamata*, Lindl.), again generically separated by Blume, but upon very slight grounds; *Hemipilia*, Lindl., two East-Indian species; and *Glossula*, Lindl., a name needlessly altered by Sprengel to *Glossaspis*, a single Chinese species.

Subtribe 3. *DISEÆ*.—The chief peculiarity of this subtribe consists in the anther, which, although continuous with the clinandrium as in the rest of *Ophrydeæ*, is more or less turned back from the top of the column. The large stigma, either concave or convex and cushion-like, is either apparently terminal on the column or in front of it immediately under the rostellum, or at the base of the column, and sometimes adnate to the labellum. The eleven following genera are all African, chiefly southern or Mascarene, one only (*Satyrium*) being also represented by a few species in East India. This genus *Satyrium*, Sw. (*Diplecthrum* Pers.), has about fifty species, readily known by the double spur of the labellum, and should include *Satyridium*, Lindl., a single Cape species supposed to differ by the very uncertain character of the two glands of the pollinarium being united into a single one, and probably also *Aviceps*, Lindl., which does not appear to be distinct from *Satyrium pumilum*, Thunb. *Pachites*, Lindl., is only known from a single South-African specimen of Burchell's already passed flower, and may prove not to be really distinct from *Disa*. *Disa*, Berg, now comprises about fifty species, distributed by Lindley or by Reichenbach into twelve series or sections very unsatisfactorily characterized. Amongst them, however, *Trichochilia*, with its grass-like radical leaves and toothed or fringed labellum, and *Disella*, with its close spike of small flowers, might perhaps be retained as good sections. *D. graminifolia*, Sw., forming Lindley's genus *Herschelia*, has the habit and characters of *Trichochilia*, except that the labellum is scarcely, if at all, toothed. *Monadenia*, Lindl., about twelve species, is distinguished from *Disa* by the large membranous somewhat folded rostellum, and by the two glands of the pollinarium united into one; the latter character, however, has been traced by Bolus in species of true *Disa*; and generally the distinction between *Disa* and its nearest allies can scarcely be settled without a study of the living plants. This Mr. Bolus has been carrying on in South Africa; and we hope to receive from him the results of his investigations before we send the *Orchideæ* of our 'Genera Plantarum' to press. *Schi-*

zodium, Lindl., contains about ten species, well distinguished from *Disa* by the habit and by the position of the stigma. *Penthea*, Lindl., seven or eight species, united by Harvey with *Disa*, appears to differ constantly from that genus in the want of any spur to the dorsal sepal. *Brownleea*, Harv., has also the dorsal sepal without any spur, but a very concave or broadly saccate labellum and a stigma somewhat different from that of *Disa*. *Forficaria*, Lindl., is only known from a single specimen of Drège's in Lindley's herbarium, which, as far as I can tell without spoiling the specimen, does not seem quite to agree with the analysis sketched by Lindley. *Brachycorythis*, Lindl., four or five species, is readily known by its habit, and differs from *Schizodium* by the want of the spur to the dorsal sepal. *Schizochilus*, Sond., four species, has been united by Reichenbach with *Brachycorythis*; but the habit is very different, and the spur of the labellum is independent of the concave unguis of *Brachycorythis*, which also exists more or less in *Schizochilus* above the spur. *Platycoryne*, Reichb. f., is a single Madagascar species, differing from *Penthea*, as *Schizochilus* does from *Brachycorythis*, in the spurred labellum.

Subtribe 4. CORYCIÆ.—In this subtribe the anther is usually more or less reflexed from the column, as in Disæ; but the labellum, adnate the whole length of the column, is produced between the anther-cells and beyond them into a variously formed appendage. The stigma, usually pressed between the labellum and the rostellum, becomes transverse or two-lobed. There are four undisputed genera:—*Pterygodium*, Swartz, including *Omatodium*, Lindl., about ten species; *Disperis*, Swartz (*Dryopeia*, Thou.), about twenty species; *Corycium*, Swartz, about ten species; and *Ceratandra*, Endl., seven or eight species. All four are South African, one only, *Disperis*, also represented by a few species in tropical Africa, Madagascar, and East India.

Tribe 5. CYPRIPEDIÆ.

The four genera constituting this tribe differ so strikingly from the rest of the order in their andrœcium, that they have been proposed as forming one or two distinct natural orders. Now, however, that they are better known, they are found to be too closely connected together not to be united in a single tribe; and the importance of the single character which separates them from Orchidæ generally has fallen so much in estimated value, that they have by common consent been reunited with that order.

as a distinct tribe only. Their habit is that of several Orchidæ (*Apostasia* often closely resembles *Corymbis*); they are all terrestrial, with erect simple leafy stems arising from a short or creeping rhizome, without tubers or pseudobulbs, their inflorescence terminal, simple, or slightly branched. Their perianth is various, but always within the limits of true Orchidæ. The column is short, bearing two perfect anthers, one on each side of the rostellum or style; the dorsal anther, the only one in other Orchidæ, is here usually reduced to a variously shaped barren staminodium; it is, however, perfect, as well as the lateral ones, in one genus, and totally deficient in one species of another genus. The rostellum or style is more or less prominent or elongated between the lateral anthers, and dilated at the end into a more or less oblique stigma. Their geographical distribution is northern or tropical; they are unknown in Africa, extratropical South America, or extratropical Australia.

The typical genus is *Cypripedium*, Linn., so well known for its slipper-shaped labellum, and agreeing with the other tribes of Orchidæ in its one-celled ovary and capsule with parietal placentas. Its cultivation for the beauty of its flowers has of late been so much the fashion, that horticulturists, by diligent research in its native localities and by careful hybridizing, have succeeded in carrying the number of its published species to above forty, several, however, to be hereafter reduced as varieties. In their wild state they are dispersed over Europe, temperate and tropical Asia, and North America, including Mexico. Their structure is far too uniform to admit of their being divided into sections, and can only be distributed into three series from minor differences in their foliage and the number of flowers, which, when more than one, are in a simple raceme, and very rarely above two or three in the raceme.

Selenipedium, Reichb. f., about ten species, replaces *Cypripedium* in the mountains of tropical America. The species have generally the slipper-shaped labellum of *Cypripedium*, under which genus most of them were first published; but a slight difference in habit and inflorescence (the flowers several in a simple or branched raceme), and the important character of the perfectly three-celled ovary and axile placentation, justifies their being maintained as a distinct genus, connecting *Cypripedium* with *Apostasia*. Two small-flowered species, *S. palmifolium*, Reichb. f., and another, have quite the habit of *Apostasia*. One species with

the labellum very little different from the petals has been published as a genus by Lindley under the name of *Uropedium*; but it so closely resembles in every other respect the *Selenipedium caudatum*, that Blume and others have suggested that it may be an abnormal peloria state of that plant analogous to the *Paxtonia* and *Argyrorchis* above referred to.

Apostasia, Blume, about four species from the Indo-Australian region, was long believed to be the type of a distinct natural order, differing from *Cypripedium* not only in the labellum, but in the perfectly three-celled ovary and capsule. Since, however, the latter character has been found to be repeated in *Selenipedium*, and the habit nearly the same as that of two species of the latter genus, *Apostasia* must be placed beside it, differing indeed only in the labellum being normally similar to the petals, and in geographical distribution. The dorsal sterile anther is usually narrow instead of being shield-shaped, and in one species is entirely deficient.

Neuwiedia, Blume, three Malayan species, is in many respects very near *Apostasia*; but, besides a few other minor characters, the dorsal anther is perfect as well as the two lateral ones. The flowers are usually small, in a dense simple spike. In both *Apostasia* and *Neuwiedia* the rostellum or style is much more elongated than is usual in *Cypripedium* and *Selenipedium*, but yet it is quite homologous in the four genera.

Notes on Cyperaceæ; with special reference to Lestiboudois's "Essai" on Beauvois's Genera. By GEORGE BENTHAM, F.R.S.

[Read February 3, 1881.]

WHEN Palisot de Beauvois published his 'Agrostographie' he intended following it up by a second volume on the Cyperaceæ; but circumstances, we are told, prevented his carrying out his project, and he handed over his manuscript to Lestiboudois, who, it appears, worked it up into the paper entitled "Essai sur la famille des Cypéracées," published in Paris in 1819. In this paper a considerable number of new genera are proposed, with short technical characters often wholly insufficient for their identification, but sometimes accompanied by a note of the species on

which they were founded, or other indications leading to their probable determination. This essay seems not to have fallen into the hands of any subsequent Cyperographers, who have only known of Beauvois's genera by the short characters copied into the *Mantissa* of the second volume of Rœmer and Schultes's *Systema* without the accompanying indications; and Nees, in the endeavour to adopt them, was obliged to make random guesses of the plants intended, which have often proved to be very wide of the mark. Kunth generally followed Nees's identifications, having no means of checking them. The following notes are the result of as careful a study of the paper itself as I have been able to make.

Among the seventeen new genera proposed, eight (*Vignea*, *Spermodon*, *Pycreus*, *Trasi*, *Hypolepis*, *Schænopsis*, *Trichelostylis*, and *Beera*) appear all to have been correctly identified by Nees or by Kunth, and are now respectively referred as sections or synonyms to various previously established genera.

Catagyne, Beauv., has not been referred to any recently known plant. The very imperfect character would seem to indicate the genus *Eriospora*, Hochst.; and this might be in some measure confirmed by the only indication given as a guide, that it is founded on a specimen communicated by Dupetit Thouars, and therefore probably African or Mascarene. But even if this supposition prove to be correct, Beauvois's genus cannot be considered as published with sufficient precision for the name to supersede Hochstetter's since firmly established one.

Zosterospermum, Beauv., could not possibly be identified by Lestiboudois's character, and nothing is said of the origin of the plant on which it was founded; but Desvaux, who probably had occasion to see an authentic specimen, gives a rather more complete character in Hamilton's 'Prodromus Floræ Indiæ Occidentalis.' This clearly indicates the *Rhynchospora sparsa*, Vahl, which I should place in the section *Pleurostachys*, Beauv., or *Nemochloa*, Nees, of that genus.

Hypoelytrum, Lestib., is evidently characterized from *Lipocarpa*, Beauv. This plant was originally included in the genus *Hypoelytrum*, Rich.; but later botanists have restricted the name to the other portion of Richard's genus.

Elynanthus, Beauv., cannot be determined with any certainty, although the chief character given is that of *Hypoelytrum*, as restricted by recent botanists. It is certainly totally different from

Elynanthus of Nees and subsequent authors. The latter genus may, however, retain Nees's name, Beauvois's genus being rejected either as quite uncertain or as a synonym of *Hypoelytrum*.

Tetralia, Beauv., rather more fully described in the 'Mémoires de l'Institut' for 1812, a Cape plant which the author says is very near the *Schœnus compar* (*Elynanthus compar*, Nees), is probably that very species, which has occasionally 8 stamens and a 4-cleft style. As Beauvois's name is founded on a character rare in the genus as now established, and as Nees's name is so generally adopted, it is better to retain the latter, although more recent than Beauvois's.

Nomochloa, Beauv., was, as we are expressly told by Lestibou-
dois, founded on the *Schœnus compressus*, Linn. (*Blysmus* of our modern Floras). Nees, with nothing before him but Beauvois's very imperfect technical character, made a very wide guess in referring it to *Pleurostachys*, Brongn., now a section of *Rhynchospora*, which by no means agrees even with that imperfect character; but he was puzzled with the name, Schultes not having transcribed the author's explanation of its derivation. Beauvois, who wished to give the idea of a marsh-plant, must have seen in some dictionary or vocabulary "*νομός*, pabulum," and in his unclassical mind, confounding *pabulum* with *palus*, thought that this was just the word wanted, and Lestiboudois boldly prints as the derivation "*νομός*, palus; *χλόα*, gramen." Nees, of course, never guessed at such a transmutation of a Latin word, and substituted *Nemochloa* for *Nomochloa*; but in a note to 'Plantæ Meyenianæ' he corrects the name back to "*Nomochloa*, from *νομός*, pabulum, and not *Nemochloa*, from *νέμος*, nemus." Again, however, in the 'Flora Brasiliensis' he says that this correction is wrong, that the real name is *Nemochloa*, because the plants he understood by it grow in shady woods, and that Beauvois so intended it, and only by a slip of the pen wrote *Nomochloa* for *Nemochloa*. All this far-fetched guesswork falls to the ground on turning to Lestiboudois's original paper.

Dichostyles, Beauv., was intended for all Brown's species of *Isolepis* with bifid styles, including the *Scirpus dipsaceus*, Rottb., or *Echinolytrum*, Desv., now referred to *Fimbristylis*. Nees transferred the name to the *Scirpus Michelianus*, now united with *Cyperus pygmaeus*, and probably not included by Beauvois in his *Dichostyles*.

Heleophylax, Desv., a genus overlooked both by Nees and by

Kunth, is apparently the *Scirpus lacustris*, Linn. (*S. tabernamontanus* of others), separated from *Scirpus* on account of the bifid (not trifid) styles, a character not constant in the species.

Limnochloa, Beauv., was intended by the author for all the species of *Heleocharis* with trifid styles. This separation not being now adopted, the name has been made use of for a section of *Heleocharis* distinguished by other characters.

Hymenochæte, Beauv., is not determinable without an authentic specimen. The author himself says that perhaps it ought to be united with *Eriophorum*; but his description does not agree with any species of that genus. Nees sought to identify it with *Scirpus grossus*, Linn., a plant still more at variance with Beauvois's character, imperfect as it is; and the name must now be altogether dropped.

Since Lestiboudois's essay, Cyperaceæ have been specially taken up by several systematic botanists. Nees von Esenbeck, in the seventh, ninth, and tenth volumes of the Linnæa, in Wight's 'Contributions to Indian Botany,' and in the great 'Flora Brasiliensis,' worked up the South-African, the East-Indian, and the tropical-American species with great ability. But he created some confusion, as well by his usual tendency to raise species to the rank of genera, as by a want of reference to the original papers or works where Cyperaceæ had been described, and by using a terminology occasionally founded on mistaken views of the homology of floral organs.

Kunth, following Nees's earlier papers, but before the publication of the Cyperaceæ of the 'Flora Brasiliensis,' elaborated the whole Order with great care and perspicuity, as far as he was able with the materials and libraries at his command. His papers in the first and second volumes of Wiegmann's 'Archiv,' and in the second volume of the Memoirs of the Academy of Berlin, clearly demonstrated the homology of the utricle of *Carex*, and generally of the floral organs in the Order; and his monograph, forming the second volume of his 'Enumeratio Plantarum,' is very much to be relied upon in every thing that he states on his own authority. His chief errors are sometimes a tendency in his general monographs to give as characters rather what in theory we ought to see than what we actually do see, and, in his later works, to describe specimens rather than species.

Studel came next, with his 'Synopsis Plantarum Glumacearum,' which would have been a very useful work if he had had any idea

of what constitutes a species or a genus. Wherever he could not readily determine a specimen he had before him, he at once described it as new, thus adding in no small degree to such confusion as Nees and others may have created.

The last Cyperographer I have to mention is Boeckeler, who seems to have a thorough knowledge of species and (in several volumes of the 'Linnæa' and of the Batisbon 'Flora') has elaborately described all those of the Berlin herbarium and of various collections submitted to him for the purpose. In so doing he has verified a number of synonyms, and often successfully rearranged some of the species of the larger genera. His labours, however, would have been much more useful if he had had access to more of the works where Cyperaceæ had been described, if he had not indulged so much in page-long uncontrasted diagnoses, if he had had rather a clearer idea of the principles upon which generic and ordinal distinctions are founded, and if he had adopted a more correct terminology. In several instances he has quite mistaken Brown's genera. The new ones he has at various times proposed have mostly proved, even upon his own admission, to be common species of well-known genera; and amongst those he has retained, one (*Lasiolipsis*) is founded upon three not uncommon species of *Eriocaulon*. As to terminology, he has, for instance (chiefly after the example of Nees), given the name of perigynium to a glume in *Carex* (Linnæa, xxxix. 1), to that which is supposed to replace the perianth *outside* of the stamens in *Lepidospermum*, to the gynophore or hypogynous disk *inside* of the stamens in *Ficinia* and *Scleria*, and to the pericarp in *Anosporum*, a supposed genus compounded of three *Cyperi* and a *Scirpus*.

Boeckeler's primary division of the order into two series, according as the fertile flower is hermaphrodite or strictly female, bears the test of a detailed examination; for in those species of *Caustis* and a few other *Rhynchosporææ* which are said to be diœcious, the fertile flowers are female only by the abortion of the anthers, the filaments are present as staminodia, at least in all the flowers I have examined, whilst in the strictly unisexual genera there is no trace of staminodia in the females or of a rudimentary ovary in the males. Boeckeler has, however, made the mistake of including in *Carpha* the strictly unisexual genus *Eriophora*, Hochst.

The three tribes into which the hermaphrodite series of genera are distributed (Kunth's four tribes reduced to three by the union

of Cyperææ with Scirpeææ), and the larger genera themselves, are far from being so strictly defined, and indeed, in several instances, do not appear to be susceptible of accurate delineation. However distinct such genera as *Cyperus*, *Scirpus*, *Schænus*, *Rhynchospora*, *Hypolytrum*, &c. may be as to the great majority of species, there will always be one, or some two or three, which might almost equally well be placed in two or more of the genera. Upon the whole, however, the following three tribes are tolerably natural and, with few exceptions, well characterized:—

1. SCIRPEÆÆ, with many-flowered spikelets and only 1 or rarely 2 empty glumes at the base; the hypogynous setæ or scales (more properly the rudimentary perianth-segments) all setaceous or all flat and regular.

2. HYPOLYTRÆÆ, with the spikelets of Scirpeææ, but within each glume 2 complicate keeled scales, placed right and left, sometimes more or less united, enclosing the stamens and pistil and in some genera 2, 4, or more narrow flat scales, often twice as many as stamens. This has induced some botanists to consider the flower rather as a spikelet, with a single female naked flower surrounded by 2 or more monandrous male flowers, each with one or two glumes—a view, however, in which I feel unable to concur, as I have already stated in my 'Flora Australiensis.'

3. RHYNCHOSPOREÆÆ.—Spikelets with 1 or 2 (rarely 3 or 4) perfect flowers, and often one or even more male flowers above or below, and usually several empty glumes at the base. Hypogynous setæ or scales present or absent, as in Scirpeææ.

There is but little to change as to the distribution of the genera into these three tribes proposed by Kunth. Boeckeler was right in transferring *Remirea* from the Scirpeææ to the Rhynchosporeææ; and I think that *Dichromena* and *Psilocarya*, as limited originally to species with many-flowered spikelets, have the habit as well as the characters of Scirpeææ; whilst the *Haloschæni*, Nees, added by Kunth to *Dichromena* as a section, and most of the South-American species added by Nees to *Psilocarya*, are correctly placed by Boeckeler in *Rhynchospora* itself. Among the other genera of Rhynchosporeææ I have already, in the 'Flora Australiensis,' proposed several alterations to Boeckeler's arrangement.

The division of the strictly unisexual series of Cyperaceææ into two tribes (Sclerieææ and Cariceææ), with or without an intermediate one of Kobresieææ or Elyneææ, has not been so clearly marked out. The utricle having been taken as the absolute character of *Carex*,

and the hypogynous disk or gynophore as that of *Scleria*, there has been much uncertainty as to the smaller genera, where these characters are modified or evanescent, or which for other reasons could not be united with either of the larger ones. The genus *Trilepis* of Nees was founded upon two species, which have but very little in common besides their unisexual flowers; and it has not been improved by the additions made to it by Boeckeler. The affinities of *Kobresia* have been studied only with relation to *Carex*, which it approaches in habit, but little in character. The fact also of the nut being enclosed in a utricle has been taken as too absolute a character, without considering that that utricle is evidently very different in structure in *Hoppia* and in *Carex*, and that it passes into an ordinary glume in some of the species usually referred to *Schænoxiphium* or to *Kobresia*, which I have collected under the name of *Hemicarex*. To me it appears that the relative position of the male and female flowers or spikelets in the inflorescence affords more natural as well as more definite, though not always quite definite, tribal and generic characters.

In all Cyperaceæ with strictly unisexual flowers, where the spikelets themselves are unisexual, the females are always 1-flowered, the males often many-flowered, very rarely 1- or 2-flowered. Where the spikelets are androgynous they contain only one female but several male flowers. Their relative arrangement supplies the chief characters of the following tribes:—

1. CRYPTANGIÆ.—Spikelets unisexual, the females either terminal, closely surrounded by males, or scattered in the *upper* part of the inflorescence. The following eight genera are all from tropical America:—

* Spikelets loosely paniculate, all separate or the males in little clusters: *Lagenocarpus*, Nees, and *Cryptangium*, Nees (including *Acrocarpus*).

** Spikelets very small and sessile, collected in androgynous heads or oblong spikes, the females uppermost or central in each head or cluster: *Fintelmannia*, Kunth (*Trilepis*, Nees, as to the Brazilian species), *Cephalocarpus*, Nees, and *Pteroscleria*, Nees. To the latter genus I would refer the *Scleria capitata*, Willd., placed by Boeckeler in *Diplacrum*, if I am right in identifying with it Spruce's n. 3763 from Venezuela.

*** Spikelets minute, in small androgynous clusters, collected in heads or corymbs, each cluster with a single female spikelet surrounded by very few males: *Calyptrocarya*, Nees, the female

spikelet without any or only very minute glumes, the androgynous clusters collected in heads, the heads in corymbose panicles; *Becquerelia*, Brongn., the female spikelet with 4 or 5 glumes half enclosing the nut, the androgynous clusters densely cymose, the cymes in corymbose panicles; *Hoppia*, Nees, the female spikelet enclosed in a utricule formed apparently of three united glumes, the androgynous clusters very numerous in one or more close compound heads.

2. **SCLERIÆ.**—Spikelets either androgynous, with one female flower at the base of several or many males, or unisexual, the females in the *lower* part of the inflorescence. Three genera: *Eriospora*, Hochst., a very natural and distinct tropical-African genus of three or four species, of which two are referred by Boeckeler to *Trilepis*, and a third to *Carpha*; *Scleria*, a large genus common to the New and the Old World, divided by Nees and others into about fourteen genera, now usually reunited; and *Kobresia*, Willd. (*Elyna*, Schrad.), including *Trilepis*, Nees, as to the Indian species from which his character was chiefly drawn.

3. **CARICEÆ.**—Female spikelets, consisting each of a single utricular glume enclosing the flower, arranged in a spike along the axis of a simple inflorescence, or of its branches, the male spikelets usually many-flowered, terminal and distinct, or continuous with the female spike above or very rarely below it, the bracts subtending the utricles or female spikelets similar to or passing into the glumes subtending the male flowers. Four genera:—(1) *Hemicarex*, a genus I should propose for some East-Indian and South-African plants which have all the characters of *Carex* except that the utricule is open on the inner side to below the middle and sometimes quite to the base, the rhachilla present, but not exceeding the glume; it includes all the *Schænoxiphia* of Boeckeler (except *S. rufum*), *Kobresia laxa*, Nees, *K. reticularis* and *K. Hookeri*, Boeckel., and *Carex linearis*, Boott; (2) *Schænoxiphium*, Nees, limited to the typical South-African *S. rufum*, Nees (*S. Dregeanum*, Kunth), with the rhachilla protruding from the utricule and proliferous, bearing several glumes either empty or enclosing male flowers; (3) *Uncinia*, Pers., a genus generally spread over the colder regions of the southern hemisphere, and extending along the Andes to Mexico and the West Indies; (4) the cosmopolitan genus *Carex*, by far the largest amongst Cyperaceæ or even amongst Glumaceæ generally.

Notes on the Vegetation &c. of Chumba State and British Lahoul; with Descriptions of New Species*. By GEORGE WATT, M.D., C.M., F.L.S., Professor of Botany, Bengal Educational Service.

[Read November 4, 1880.]

(PLATES IX.—XIV.)

Remarks on the Physical Features of the Country traversed.

TOWARDS its western extremity the vast Himalayan chain divides into many approximately parallel ranges. Starting from the upper valley of the Sutlej, and passing from north-west to south-east, these ranges are separated by deep well-defined valleys, from which the Indus obtains its five Punjab streams. To the south of the Indus valley proper, the ranges are collectively known as the Outer or higher Himalayas; and the three visited by me may be conveniently referred to as the First, Second, and Third ranges.

I. THE FIRST RANGE.—Being nearest the plains of India, this is the one upon which the British sanatoria (Dalhousie, Simla, &c.) are situated. From it spurs are given off having a more or less southerly direction, and becoming lower and lower as they approach the plains. So also to the north, or rather north-east, spurs are thrown out, becoming gradually lower and lower into the Ravee valley. The First Range and its spurs and low detached hills thus stand between the Upper Ravee basin and the plains. Having toiled for two or three days, I found myself on the summit of the First Range, which varies in altitude from 8000 to 14,000 feet above the level of the sea. Looking southward, the plains may be seen in the far distance, and the sterile hills of loose conglomerate, fissured by denudation, appear as if thrown away from the whinstone rocks that have burst through them. Looking forward and down into the valley of the Ravee, spur after spur at right angles again and again mingle and intermingle in utter confusion, sinking to the depths of the Ravee basin, and gathering themselves up, rise higher and higher, series above series,

* [This communication, when read, was entitled "Contributions to the Flora of the North-western Himalayas;" but at the suggestion and by leave of the Council its scope has been somewhat modified, and the title changed accordingly.—Ed.]

until lost in the slopes of the snow-capped Second Range. The whole of this panorama of low hills and spurs, filling up the space from the First to the Second Range, constitutes the basin of the Ravee. It extends eastward to a point where these two ranges seem to unite through the lofty spur which forms the Andrar Pass, and separates the head-waters of the Ravee from those of the Bias. From the Andrar Pass the Upper Ravee basin extends north-west to a little below Chumba city, and then turns south-west to Shoojanpore. The whole of this country is designated the Ravee basin in these notes. Having fully admired the bewildering confusion of low hills of the Ravee basin, I commenced the descent to the Ravee and Chumba city. The road leads through magnificent forests of *Cedrus Deodara*, a tree which is extremely rare on the southern slopes of the First Range. In a few hours Chumba city, at an altitude of 3000 feet, was reached; and I began to realize the fact that I was in a new country and amid a new people. The giant Man-Mahesh and his fellows, sifting and purifying the air, intervenes between the damp malarious plains of India; and the nature and condition of the vegetation reminds one that he has advanced one stage away from the excessive rains of India towards the dry regions of the Inner Himalayas. The changes in the vegetation on crossing each of the three successive ranges of this region point conclusively to the great influence exercised by high mountain-ranges in the distribution of plants. It must not be supposed, however, that it is always mere altitude or snow that exercises this influence; for the changes observable on crossing from the southern to the northern slopes of the First Range are quite as great as those observed on crossing from the one side to the other of the Second Range with its perpetual belt of snow. It is much more likely that the degree of humidity has to do with these changes, since they are observable on the sides of a range over which there could be no other difficulty in the way of plants spreading from the one side to the other.

II. THE SECOND RANGE.—From Chumba the road takes the traveller through low hills to the spurs and slopes of the Second Range; and after five or six days march he finds himself in a narrow cutting through the snows, forming one of the many lofty passes (from 15,000 to 19,000 feet in altitude) leading from the Ravee basin into that of the Chundra-Baga, as the Upper Chenab

is here called. The basin of the Chundra-Baga extends from Kistawar in the north-west to the western high mountains of Spiti. It is divided into three portions—namely, Pangî or Chumba, Lower Lahoul, and Upper or British Lahoul.

Pangî.—Inhabited by an Aryan race of people, quite different in their social habits (being polyandrists), speaking a different language and professing a different religion, and altogether isolated from the other hill-tribes of this region. Their summer is short, compelling them to hibernate for nearly half the year, a peculiarity shared in by many of the animal and vegetable inhabitants of the valley. Immediately on the melting of the snow in May nature bursts into life; and the hibernating inhabitants escape from their close dingy houses. Like their goats, they take to eating many of the fresh green leaves. I noticed that my coolies had not got over their greed for green leaves in the latter half of May. While resting on the road they ate the young leaves of one or two umbelliferous plants raw, and also bruised, and baked them in their thick cakes of coarse bread. I was surprised at their refusing to eat *Nasturtium officinale*, preferring the umbelliferous leaves to any thing else. It is noteworthy that the domesticated fowl, however well cared for, cannot survive the winter in Pangî. The atmosphere is dry in summer, infinitely drier than in the Ravee basin; and a comparison of the plants confined to Pangî, or not found in the Ravee basin, will show how visibly this change in the degree of humidity is attended with a change in the vegetation. An equally well-marked boundary-line was observed in the distribution of both birds and butterflies; and it is a singular fact that while several Batrachians are common in the Ravee basin, not one is known to inhabit Pangî or Lahoul. The valley of Pangî is nowhere more than a quarter of a mile in breadth, with snow-capped ridges bounding it on both sides.

Lower Lahoul.—The wildest and most sterile portion of the basin, where the traveller must be constantly on the alert to avoid accidents. For miles the road is utterly impassable to any beast of burden; and even man must be possessed of considerable nerve and agility to accomplish a good day's march in Lower Lahoul. At many points the road is limited to a plank laid across iron crowbars driven into the face of a mural precipice rising 2000 or 3000 feet overhead, with the roaring Chundra-Baga several hundred feet below. At Triloknath the valley widens and becomes more interesting.

British Lahoul.—The inhabitants are Mongolians and Buddhists. At Tandi the Chundra and the Baga join. The former rising to the south-west of the Bura-Lucha Pass, and describing an arc of a circle by south-east to north-west, washes the mountains of Spiti and drains the northern slopes of the Rotang Pass; the Baga, rising almost at the same point, describes also an arc of a circle, passing south-east and south to join the Chundra. At Keylang, on the Baga, I found the good Moravian Missionaries not only able to assist me, but ready and willing to permit me to inspect their interesting collection of Lahoul plants. I shall be pardoned for acknowledging here the great help I received from my kind friends in Keylang, the Rev. Mr. Heyde and the Rev. Mr. Redslob.

III. THIRD RANGE.—The ascent may be made from Keylang to the Bura-Lucha Pass (17,000 feet), where the Chundra-Baga valley terminates. From the Bura-Lucha Pass the road leads through Zanskar to the capital of Ladak on the northern bank of the Indus.

Climate and Vegetation.

The following remarks on the climate and vegetation should be understood as applying to the route taken by me, rather than to the country generally, though many of them are of general application.

Not only do the three Ranges described divide the Punjab Himalayas into distinct drainage-areas, but they separate three regions with widely different climatic conditions. The First or southern region extends from the Punjab plains to the summits of the First Range. This may be described as very rainy, although it must be remembered that the annual rainfall occurs during part of four months only, and that during the rest of the year this region is dry, hot, and altogether below the line of perpetual snow. The Second region extends from the summit of the First to the summit of the Second Range. This may be characterized as a fairly rainy basin, corresponding to the Ravee, Bias, and the greater part of Kashmir: while the total rainfall is less, the annual and average humidity is greater and, like the temperature, more equable; so that the vegetation of the region is much richer than in the preceding, and contains a much larger proportion of temperate types. The snow-line descends to about 15,000 feet; but during winter months the snow lies as low down in the Ravee

basin as 3500 feet, whereas it never lies much below 7000 feet in the First or southern region. The Third region extends from the summits of the Second Range to the Indus valley. This may be described as almost rainless, only a few inches falling throughout the entire year. The greater part of this region, however, is under snow for about seven months; and consequently trees become extremely rare—herbaceous and annual vegetation rapidly clothing the luxuriant hill-sides during the short summer. While the atmosphere is very dry and mild, the soil is everywhere constantly damp during summer, the hill-sides being permeated by streamlets from the melting snow. I may here mention that the staple product of cultivation in this region is barley. It is cultivated in all the lower, rich, moist fields; while wheat has assigned to it the drier, exposed, poor, rocky soils. In fact, at high altitudes wheat only will yield a good harvest. It is often cultivated in Lahoul up to 14,000 feet.

General Vegetable Features of the First Region.—Without enumerating all the plants found in these regions, and thereby unnecessarily repeating mere lists of names, it may be remarked that on leaving the plains, and for several miles, the loose conglomerate and heavy clay-soil is clad with but scanty vegetation. There are no forests, except dense bamboo-jungles and the usual subtropical bushes and herbaceous plants which accompany the bamboo. At 2500 feet, in the shady hill-sides, scattered clumps or small woods of *Pinus longifolia* first appear, and alternating with these open wooded expanses, chiefly of *Cassia Fistula*, *Acacia Catechu*, *Indigofera purpurea*, and *Grewia oppositifolia*. At 3500 feet these disappear, and *Albizia Julibrissin* and *A. odoratissima* take their place, along with the extensive scandent bushes *Bauhinia Vahlii*, and ultimately *Rosa moschata*. About the same altitude *Berberis aristata*, *B. Lycium*, and *B. nepalensis* become very abundant, and continue till the higher pine-forests are reached (about 7000 feet). It is remarkable how constant the subtropical or, at most, warm temperate character of this region is kept up from the plains high up into the mountains. Thus, for example, out of 55 species of *Ranunculaceæ* collected by me in the Punjab Himalayas, only six occur south of the First Range; and these are all almost tropical. Two of them, for example, are common to the plains, viz. *Ranunculus sceleratus* and *R. muricatus*; while the only other *Ranunculus* is so far subtropical as to be almost confined to this region, viz. *R. lætus*. It is curious that

while a form of *R. aquatilis* occurs in pools in the Punjab, it entirely disappears until the Himalayas proper have been crossed, when it is again met with in Lahoul. *Anemone rivularis*, which occurs abundantly on the higher slopes of this region, is also much more tropical in its character than any other member of its genus, being the only species which extends to the mountains of Southern India. This same peculiarity might be shown with every other order. Thus, Fumariaceæ 13 species, none in the First region; Cruciferae 43, with two species in this region common to it and the Second; Caryophyllaceæ 26 species, of which two occur here, one (*Gypsophila cerastioides*) almost confined to the higher slopes of the First Range (a very characteristic and handsome plant), alt. 5000–12,000 feet; Geraniaceæ 19 species, of which *Geranium lucidum* and *G. ocellatum* (the species which extend to the low hills of the Peninsula) are the only Geraniums met with, while only one Balsam appears to occur, viz. *Impatiens amphorata*. Of 52 Papilionaceæ only four were met with, and of 51 Rosaceæ only three species, in the First region. Of Primulaceæ only four species were seen. One of these, *Primula floribunda*, may be considered the subtropical member of this interesting genus, belonging to a group which becomes diffused eastward to China and Japan, and is characterized by having conduplicate vernation and more or less foliaceous bracts. *Androsace incisa* descends to about 3000 feet, and is spread all over this and the Second region; but the higher and snow-capped middle range forms almost an artificial boundary-line in its distribution; for its place is immediately taken, on crossing to the north of this range, by its nearest ally, *A. cordifolia*. *A. sarmentosa* is also confined to the north of the middle range; while *A. lanuginosa* is very abundant on the warm temperate slopes of the First Range. Ferns are extremely rare in the Southern or First region, only four species having been detected; and these are all of a subtropical character, *Asplenium alternans* being the characteristic fern.

Flora of the Second Region.—Immediately on crossing to the north of the First Range a marked change in the vegetation is noticeable. Dense forests of immense *Cedrus Deodara* were entered; and herbaceous plants, which only appeared at 7000–10,000 feet on the south, were here seen to descend to 3000 feet towards Chumba city. I shall not enter into a detailed description of the plants of this region, as it may in a few words be described as inhabited by the typical vegetation of the North-west Himalayas.

It is free from the subtropical types which so largely help to make up the flora to the south of the First Range, as it is also free from those forms which bring to the Third region so much of its Central-Asiatic and Siberian character. Perhaps the most striking exception to this remark is to be had in the appearance of *Geranium divaricatum*, which finds its most eastern station in Kumaon.

With the exception of the forests of *Abies Smithiana*, *A. Web-biana*, and *Cedrus Deodara*, there are no other trees that can be said to form forests. *Æsculus indica* is the largest and most handsome tree of this region, its bark scaling off in long linear patches in a manner peculiar to itself. Near villages *Cedrela Toona*, *Melia Azedarach*, and *Crataeva religiosa*, along with *Bauhinia variegata*, are also sufficiently abundant to attract attention, and, were it not that they are undoubtedly introduced, would form a curious exception to the decided temperate feature of this region. *Euonymus Hamiltonianus*, *Prunus Armeniaca*, *Zizyphus vulgaris*, *Rhamnus purpureus*, *Cornus macrophylla*, and *Andromeda ovalifolia*, with one or two species of Oak, Poplar, and Willow, and occasionally also *Juglans regia*, are the chief deciduous trees of this region. Of bushes and herbs the following are the most abundant—*Zanthoxylum alatum*, *Skimmia Laureola*, *Prunus Padus*, *Viburnum cotinifolium*, *Celastrus paniculata*, various species of *Rubus*, with miles of hill-sides covered with *Rosa moschata* and *Clematis Buchananiana*. At the same time various species of *Berberis* fill up the bushy character of a large portion of this region. It is in fact only in the dark shady tributary valleys that arboreous vegetation seems able to exist; and up these damp and verdant glens many interesting herbaceous plants may be gathered. The bright blue clusters of *Delphinium denudatum*, mingling with various species of *Potentilla*, *Ranunculus*, three or four species of *Hypericum*, Geranium, Balsam, *Spiræa*, and many others, make these charming shady places of peculiar interest. The scarcity, however, of epiphytal and parasitical plants is very striking, and tends largely to deepen the impression that the Western Himalayas, as compared with the Eastern, are much more Siberian in their character. This must be accounted for by the limited amount of rainfall and humidity in the west. At about 7000 to 8000 feet pine and cedar forests commence, and with these a great increase of herbaceous vegetation, chiefly Ranunculacæ, Cruciferæ, Caryophyllacæ, Leguminosæ and Rosacæ, but parti-

cularly also an increased number of species of Compositæ, Primulaceæ, Labiateæ, and Ferns. Lichens and Mosses also become very abundant; but, as pointed out to me by Dr. Stirton, they are, in common with those from the plains of India, chiefly in an arrested state, the apothecia being imperfectly developed. *Clematis montana* and a scandent Caryophyllacea (*Cucubalus bacciferus*) are especially abundant. On leaving the belt of pine-forests, stunted Oaks, the Birch, and *Rhododendron campanulatum* were met with. Above these a species of Juniper up to 14,000 feet, becoming ultimately a prostrate woody creeper not six inches above the ground. Along with this, in July and August, a bewildering glow of colours clothes the hill-sides to the foot of the snows, in which the primary colours predominate. The following bright-blue flowers were collected within a radius of 1000 yards—*Delphinium Brunonianum*, *D. vestitum*, *Aconitum Napellus*, *A. heterophyllum*, *Meconopsis aculeata*, Royle (the most handsome N.W. plant), *Corydalis cachemiriana*, *Primula denticulata* (*P. purpurea*), *Gentiana*, sp., and *Myosotis*, sp. With these *Primula rosea*, covering large patches and intermingling with an immense number of yellow flowers, forms a perfectly dazzling flower-bed, relieved by the wreaths of snow amongst which they are found.

Third Region.—On crossing the middle and principal chain into the valley of the Chundra-Baga a much more marked and striking change in the vegetation was noticed. New families appeared; and many but poorly represented in the Second region were here found to suddenly double their number of species. Thus, in Ranunculaceæ 6 species are in the First region, 22 in the Second, and 41 in the Third, of which 14 were common to the Second and Third regions. Fumariaceæ 13, of which 7 are confined to the Third region, while only 2 seem confined to the Second. Of 43 Cruciferae, 26 are contained within the Third region, while only 4 species seem peculiar to the Second. Tamariscineæ make their appearance in this region; and, indeed, *Myricaria germanica* is one of the commonest bushes throughout Lahoul. It is, however, in Papilionaceæ and Rosaceæ that the most marked change takes place: thus, out of 52 Papilionaceæ, 27 seem peculiar to the Chenab valley, or were not recorded in the Ravee basin. Of 51 Rosaceæ, 25 are found in this region only, with, in addition, 10 which are also found in the second region.

The deciduous forests of the Third region are composed of a number of trees unknown or only introduced in the south of the

middle range, so that in the lower Chundra-Baga (which corresponds to Pangî), they are very striking, viz. *Acer cæsiûm*, *Acer pictum*, *Cratægus Oxyacantha*, *Fraxinus excelsa*, *F. Moorcroftiana*, *Corylus Colurna*; and, mingling with these forests and extending to the exposed hill-sides, the following bushes are very characteristic:—*Abelia triflora*, *Lonicera* (four species), *Parrotia Jacquemontiana*, and three species of *Cotoneaster*, conspicuously absent from the Second region (their place being taken by *Berberis*); four species of *Pyrus*, and particularly *Rosa macrophylla* and *R. Webberiana* taking the place of the very abundant and scandent Rose of the Second region. Three species of *Ribes*, and the appearance of *Deutzia* and *Philadelphus*, are striking characters of this region. It is remarkable, however, that while *Rhododendron campanulatum* is extremely common upon the south, it is nowhere seen in the north, nor indeed any other *Rhododendron*, except in Upper Lahoul, where the minute form makes its appearance. Extensive forests occur in Pangî; but on ascending the Chenab arboreous vegetation gradually disappears, and, except here and there, where *Pinus excelsa* and *Juniperus excelsa* form dense forests, no trees are to be found. The Birch and Juniper also in time disappear, until in Lahoul only a cultivated Willow is met with. This total disappearance of the trees from Lahoul forms perhaps its most noteworthy feature.

In addition to the diminution of humidity, the fall in temperature on passing across these regions must also largely account for the changes in the vegetation; indeed, since Pangî and Lahoul alike depend for their moisture more upon the melting snow than the rainfall, it must be attributed only to the aridity of the climate of Lahoul that arboreous and bushy vegetation disappears from that country.

In conclusion, the existence of marked changes within so limited a territory shows how very important it is, in reporting collections from mountainous countries, to note carefully the river-basin from which the specimens were gathered.

I should mention that I am greatly indebted to my friend Dr. Hutchison for kindly superintending the operations of my native collector in Chumba, and to Mr. Ellis, Forest Officer, Pangî, for adding to my collection much valued material. My sudden recall to India has necessarily prevented my personal revision of the proof-sheets, which Mr. W. B. Hemsley has kindly undertaken for me.

Description of New Species &c.

RANUNCULUS PANGIENSIS, n. sp. (Plate IX. B. figs. 3-9.)

Perennis, repens, ramosus, 1-2½ ped. altus, omnino pilosus, pilis sparsis longis albidis patentissimis. *Radices* carnosæ, claviformes, fasciculatæ, 6-12 lineas longæ. *Caules* e nodis rhizomatis, solitarii, crassiusculi, striati, basi simplices, fistulosi. *Folia* radicalia et caulina inferiora graciliter petiolata, 3-6-pollicaria, subtritermata, segmentis angustis pinnatifidis trifidis vel bifidis, caulina superiora sessilia, tripartita vel simplicia. *Flores* flavi, 9-12 lineas diametro, corymbosi, longe pedunculati; pedunculi striati vel leviter sulcati. *Sepala* ovato-oblonga, recurva. *Petala* obovato-rotundata, infra medium nectarifera. *Receptaculum* maturum elongatum. *Achenia* numerosissima, lævia, glabra, subplana, uncinata. Pangi, 8000 feet.

R. HIETELLUS, *Royle*.

An exceedingly variable species, averaging from 2 inches to more than a foot in height, and constituting two parallel sets of forms—the one perfectly glabrous and having larger flowers with a more elongated receptacle, the other more or less hairy and often very small-flowered. The former is of a much more alpine character, often growing in the snow, and never descending below 10,000 feet. It is distributed from the northern slopes of the Second Range throughout Pangi, Lahoul, and Ladak, whereas the latter extends southward from the Second Range, at altitudes from 4000-12,000 feet.

R. SCELERATUS, var. MYOSUROIDES, nov. var. (Plate IX. A. figs. 1, 2*.)

Robustus, 2-3-pedalis, valde ramosus et foliosus. *Folia* caulina 3-5-partita, segmentis latis grosse serratis basi attenuatis. *Flores* minuti. *Receptaculum* post anthesin elongatum, usque 6 lineas longum, arcuatum, glabrum, nudum.

On the ascent to Noorpore, Punjab.

A very singular variety of *R. sceleratus*, in which the oblong receptacle elongates as much as half an inch after shedding the achenes, and becomes quite naked and curved.

R. DIFFUSUS, var. HYDROCOTYLOIDES, *Wall.* (species). Tandi, Lahoul, 10,000-12,000 feet.

A very distinct stemless form, having thick, fleshy, fusiform

* The receptacle is incorrectly represented as being hairy.

roots, and small yellow flowers with hooked styles. The ordinary *R. diffusus* from the same region is a much larger rambling plant, having fibrous roots, white flowers, and straight styles.

AQUILEGIA GLAUCA, var. *NIVALIS*. Northern slopes of the Second Range, 14,000 feet.

Flowers solitary, very large (1-2 inches), deep purple. A very striking plant, not more than 4-6 inches in height.

ARABIS PANGIENSIS, n. sp. (Plate X. figs. 1-11.)

Perennis, caespitosa, stellato-puberula, caudice crasso ramoso foliis vetustis vestito; caules floriferi graciles, ramosi, 4-6-pollicares. *Folia* crassa, radicalia confertissima, obovato-spathulata, integra vel paucidentata, 1-2-pollicaria, caulina lineari-lanceolata, obtusa, basi attenuata. *Flores* albi, parvi, numerosissimi, laxe racemoso-paniculati; pedicelli filiformes, adscendentes. *Sepala* oblonga, concava, basi aequalia. *Petala* lineari-spathulata, $2\frac{1}{2}$ -3 lineas longa. *Stamina* subaequalia. *Siliqua* glabra, tenuis, linearis, usque ad sesquipollicaris, saepe plus minusve arcuata. *Semina* oblonga, semialata, uniseriata, cotyledonibus incumbentibus.

Crevice of rocks throughout Pangí, at 8000-10,000 feet.

A. BIJUGA, n. sp. (Plate XII. figs. 1-7.)

Perennis, glabra vel glabrescens, glauca, caespitosa, a basi ramosa, caulibus gracilibus 9-18-pollicaribus. *Folia* crassa, parcissime pilosula, vel margine tantum ciliolata, radicalia conferta sed vix rosulata, obovato-spathulata, infra medium attenuata, $1\frac{1}{2}$ -3-pollicaria, paucidentata, caulina lineari-oblonga, obtusa, basi angusta. *Flores* albi, majusculi, laxissime racemoso-paniculati; pedicelli filiformes, 9-15 lineas longi, arcuato-patentes. *Sepala* ovato-oblonga, petalis triplo breviora, lateralia basi saccata. *Petala* late obovata, per paria divaricata, usque ad 8 lineas longa. *Siliqua* (matura non visa) tenuis, angustissima, 2-2 $\frac{1}{2}$ -pollicaris.

Pangí, 8000-9000 feet.

Allied to *A. alpina*, from which it differs in being almost quite glabrous and glaucous, in having larger flowers in very loose racemes, in the petals diverging in pairs, &c.

SISYMBRIUM THOMSONI, Hook. f. in *Journal Linn. Soc.* v. p. 161. Pangí, Lahoul, 9000 feet.

This species seems to have been overlooked in Hooker's 'Flora of British India.'

VIOLA BIFLORA, L. Common in woods on the southern slopes of the First Range, 10,000 feet.

This species is quite distinct from *V. Wallichiana*, which has been united with it in the 'Flora Indica.' The differences are in

the length of the spur and the form of the style, independently of general features.

VIOLA PATRINII, DC. Lower spurs of the First and Second Ranges, 3000–7000 feet.

V. PATRINII, var. *SUAVEOLENS*, Watt.

Subcæspitosa, foliis angustioribus obtusis, stipulis sæpissime denticulatis, floribus majoribus fragrantissimis, petalis erectis, caldari longiore, stigmatate oblique triangulari.

Higher southern slopes of the Second Range.

V. CANESCENS, Wall. in *Roxb. Fl. Ind.* ed. 1824, ii. p. 450. (Plate XI. B. figs. 6–10.)

Sarmentosa, foliis confertissimis canescentibus rotundato-cordatis crenato-serratis, sinu angusto, stipulis insigniter laciniato-fimbriatis, sepalis lineari-lanceolatis, caldari brevi lato rotundato, stylo recto deorsum gradatim attenuato, stigmatate terminali truncato integro depresso.—Wall. *Cat.* 1442, *ex parte*.

A smaller plant in all its parts than *V. serpens*, having hoary, olive-green, thick leaves, 6–12 lines across, and white flowers, with the petals 3–4 lines long, not half the size of the purple flowers of *V. serpens*.

From the southern spurs of the First Range to the southern spurs of the Second Range, 3000–8000 feet. Distributed from Kumaon westward to Kashmir, inhabiting dry, exposed situations.

V. SERPENS, Wall. in *Roxb. Fl. Ind.* ed. 1824, ii. p. 449, non Wall. *Cat.* (Plate XI. A. figs. 1–5.)

Caulescens, foliis paucis pilis sparsis appressis late cordatis acuminatis serratis, sinu lato, stipulis integris vel interdum obsolete denticulatis, sepalis ovato-lanceolatis, caldari elongato subrecurvato, stylo clavato basi subito constricto curvato, stigmatate laterali longe rostrato.—*V. aspera*, Ging.; *V. pilosa*, Bl.; *V. palmaris*, Buch., non Ham.; *V. Hamiltoniana*, Don; *V. repens*, Ham.

V. serpens, as limited in the 'Flora Indica,' includes, in addition to some of the foregoing synonyms, *V. canescens*, *V. Wrightiana*, and *V. Griffithiana*, all of which should be regarded as distinct species. *V. Griffithiana*, if viewed as a variety only, must be placed under *V. serpens*, and not *V. canescens*, as in 'Flora Indica.'

Distributed throughout the slopes of the Second and Third Ranges, 7000–10,000 feet.

[*V. distans*, Wall. Cat. 4022, has also been confused with *V. serpens*, from which it differs in its very stoloniferous habit, fimbriated stipules, straight, thicker styles, terminal three-lobed stigma; the two lateral lobes erect, broad, and flat, the third forming a short beak. The correct synonymy of this species is as follows:—*V. Metsiana*, Hohen.; *V. Notoniana*, Wall. Cat.; *V. palmaris*, Ham. non Buch.; *V. repens*, Buch.; and probably *V. Royleana*, Wall.]

VIOLA CANINA, L., var. *SYLVATICA*, *Fries* (species). Extremely common in Pangl, and extending into Lahoul.

V. ARENARIA, DC. Keylang, Lahoul, 10,000–14,000 feet.
Not previously recorded from India.

V. KUNAWARENSIS, *Royle*. Lahoul to Zanskar, 13,000–15,000 feet.

GERANIUM GRANDIFLORUM, *Edgew.* Occasional on the southern slopes of the Second Range, and very abundant in damp deciduous woods in Pangl, and extending to Lahoul.

This is referred to *G. palustre*, L., in the 'Flora Indica,' from which it is quite distinct, though it may be merely a variety of *G. pratense*, L.

G. DIVARICATUM, *Ehrh.* Southern slopes of the Second Range, Ulwas &c., 5000–8000 feet.

The plants referred to in the 'Flora Indica' under *G. molle* all belong to this species, which is readily distinguished from *G. molle* by its very robust habit, palmately-lobed leaves, and setulose carpels. It is a very coarse plant, frequently growing several feet high in bushes and hedges.

G. divaricatum has a wide geographical area, extending from Eastern Europe through Central Asia and Siberia to Soongaria, Kumaon being its most easterly station in India, whereas *G. molle* does not appear to penetrate eastward beyond Asia Minor.

SOPHORA MOLLIS, *Grah.* Lower slopes of the Upper Ravee below Barmour, 6500 feet.

This is a low bush, covering large expanses of the hill-sides, extending for several miles. It is a remarkable fact that every plant exhibited the peculiarity of bearing an abundance of long, filiform, hoary outgrowths proceeding from various parts of the plant, such as the apex, base, and middle of the leaflets, the apex of the rachis, the fruit, etc.

BAUHINIA VAHLII, *Wight & Arn.* Low hills south of the First Range, up to 35,000 feet.

The tendrils of this plant are very interesting, being formed from abortive leaf-buds, and not from inflorescences nor from true leaves. In many instances they appear at first sight as if formed from the two lateral leaflets of a trifoliate leaf; but upon closer examination the petiole of what would in that case be the terminal leaflet will be seen to be jointed and to bear an abortive bud. Should this bud develop, the tendrils then appear to be opposite upon a branch bearing alternate leaves. Both conditions frequently occur, as well as solitary leaves borne upon abortive lateral branches destitute of tendrils. Sometimes, too, when one of the opposite tendrils succeeds in attaching itself to an object, the other ceases elongating and produces a number of abortive leaves, thus exhibiting an effort to become a normal leaf-bearing branch.

ANDROSACE MUCRONIFOLIA, n. sp.* (Plate XIV. B. figs. 3-8.)
Herba cæspitosa nana. *Folia* obovato-elliptica, mucronato-uncinata, glabra.
Capsula ovata; semina 2, anguste alata.

Alpine Himalaya, alt. 13,000 feet. Thibet (*T. Thomson*); Kashmir (*C. B. Clarke*); Lahoul (*Watt*).

PEDICULARIS (verticillatæ longirostres) EXIMIA, n. sp. (Plate XIII. figs. 1-6.)

Herba annua (♀), puberula, caule simplici 9-18-pollicari. *Folia* angusta, pinnatifida vel subbipinnatifida, 3-6-pollicaria. *Flores* lutei, speciosi, numerosissimi, breviter pedicellati. *Calyx* antice fissus. *Corollæ* tubus angustus, calyce vix duplo longior; galeæ rostrum arcuatum, basi bistortum, apice bifidum. *Filamenta* glabra. *Capsula* glabra, cuspidata, 9-14 lineas longa; semina oblonga, punctata.

North-west Himalaya, 8500-13,000 feet (*Thomson*, 23; *Falconer*, 793; *Jäschke*, 200; *Watt*, 49 A, 97 B, 210 G).

ADIANTUM WATTII, *Baker*, n. sp. (Plate XIV. A. figs. 1, 2.)
Stipite elongato gracili nudo castaneo, fronde rhomboidea tripinnata glabra modice firma utrinque viridi, pinnis inferioribus deltoideis distincte petiolatis basi inferiore cuneato-truncatis, segmentis tertiariis integris vel ex apice profunde parce lobatis margine extrorsum leviter crenulato, lateralibus subquadratis, inferioribus brevissime petiolulatis, terminalibus cuneatis, soris ad segmentum 1-3 orbicularibus vel oblongis, involucre angusto firmo glabro persistente.

* A fuller notice of this new plant I hope to give in a future communication on the Indian species of the genus.

Stipes 3-4-pollicaris; lamina 4-5 poll. longa, 2-2½ poll. lata. Pinnæ erecto-patentes, superiores sensim minores, inferiores 1 poll. latæ, petiolo semipollicari; segmenta tertiaria subquadrata 3-4 lin. longa, cuneata, terminalia 2-3 lin. lata. Involucrum ½ lin. latum, ½-1½ lin. longum.

Intermediate between *A. venustum* and *A. Capillus-Veneris*: most like the former in size and general habit, but the outer edge of the barren segments obscurely crenulate, not distinctly toothed, the sori narrower and often confluent, and not distinctly indented into the segment, and the involucre different in size and shape, not nearly so large or so firm in texture.

DESCRIPTION OF THE PLATES.

PLATE IX.

A. 1 & 2. *Ranunculus sceleratus*, L., var. *mysuroides*, Watt.

Fig. 1. Flower and fruit, natural size; 2, elongated receptacle after shedding the achenes (but incorrectly represented hairy).

B. 3-9. *Ranunculus pangiensis*, Watt.

Fig. 3. Portions of a plant, natural size; 4, vertical section of a flower; 5, a sepal; 6, a petal; 7, a stamen; 8, an achene; 9, an achene cut open.

PLATE X.

1-11. *Arabis pangiensis*, Watt.

Fig. 1. Portion of plant, natural size; 2, flower raceme; 3, a flower; 4, a sepal, side view; 5, a petal; 6, a stamen; 7, stigma; 8, a siliqua; 9, a portion of the same with the valve removed, showing the arrangement of the seeds; 10, section of an embryo; 11, stellate hair.

PLATE XI.

A. 1-5. *Viola serpens*, Wall.

Fig. 1. A leaf; 2, stipule; 3, a sepal; 4, spur; 5, a pistil.

B. 6-10. *Viola canescens*, Wall.

Fig. 6. The plant, natural size; 7, stipule; 8, a sepal; 9, stamens; 10, a pistil.

PLATE XII.

1-7. *Arabis bijuga*, Watt.

Fig. 1. A plant, natural size; 2, margin of leaf, enlarged; 3, a sepal; 4, a petal; 5, a stamen; 6, part of siliqua; 7, section of siliqua with ovules.

PLATE XIII.

1-6. *Pedicularis eximia*, Watt.

Fig. 1. Portion of a plant, natural size; 2, the calyx; 3, tip of beak; 4, stamens; 5, a single stamen; 6, capsule.

PLATE XIV.

A. 1 & 2. *Adiantum Wattii*, Baker.

Fig. 1. Portion of frond; 2, a pinnule.

B. 3-7. *Androsace mucronifolia*, Watt.

Fig. 3. The plant, natural size; 4, the leaf, enlarged; 5, bract; 6, the calyx; 7, corolla laid open.



A. 1, 2 RANUNCULUS SCELERATUS, L. var. MYOSUROIDURONORUS; URU
 B. 3, 9 " " PANGIENSIS, Waddell



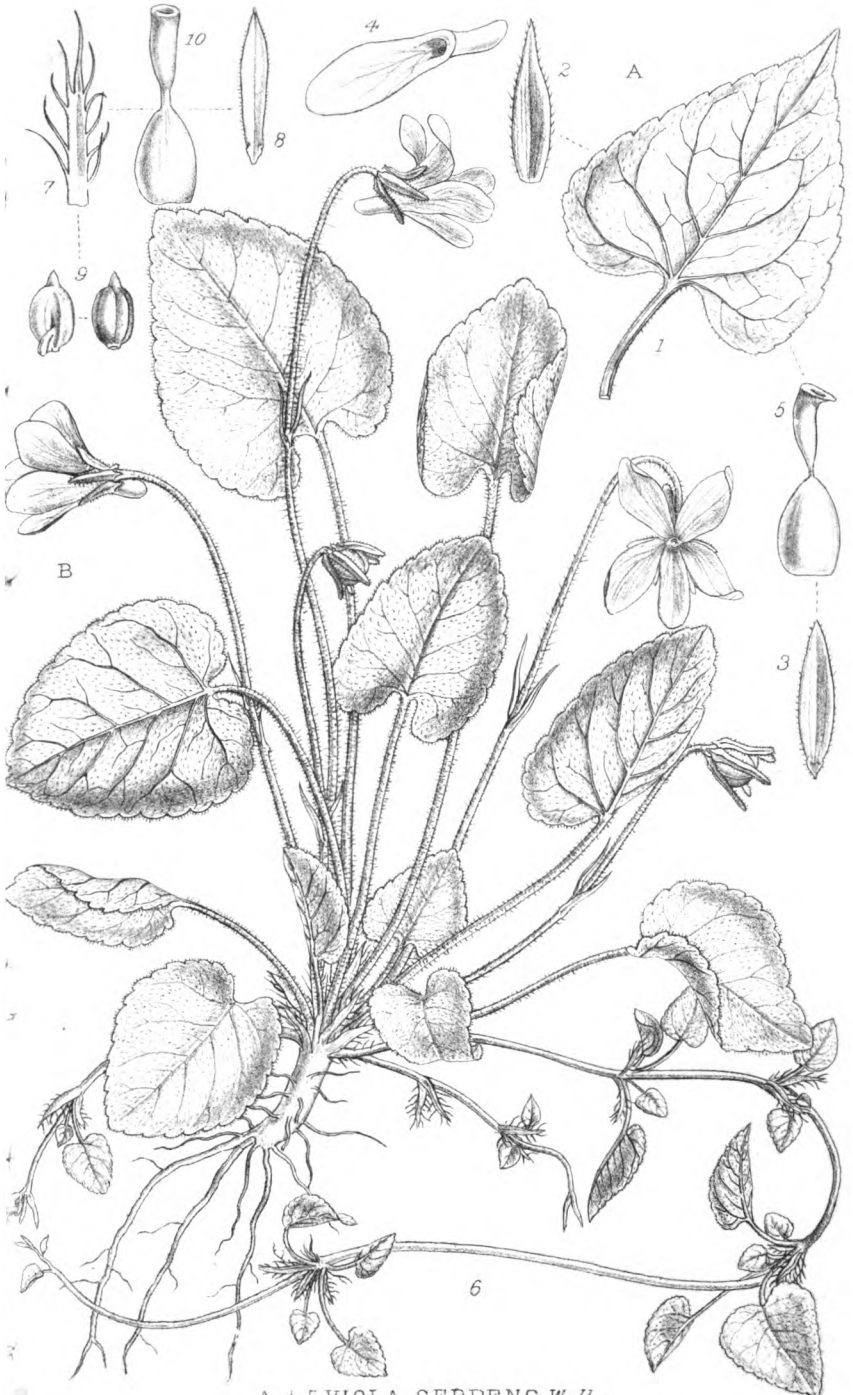

A, 15 VIOLA SERPENS, Wall.
 B, 6, 10 " CANESCENS, Wall.

D. Blair lith.

Fitch imp.





Blair & Fitch lith

PEDICULARIS EXIMIA, Watt.

J.N. Fitch imp.

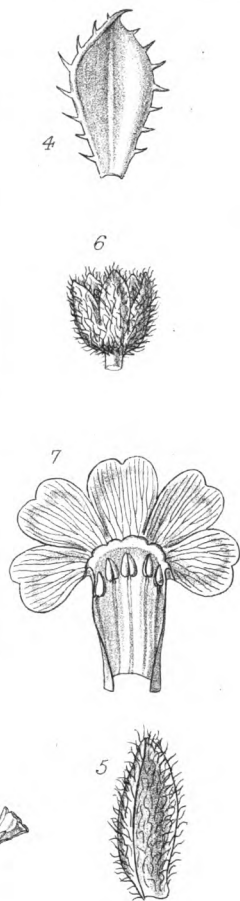
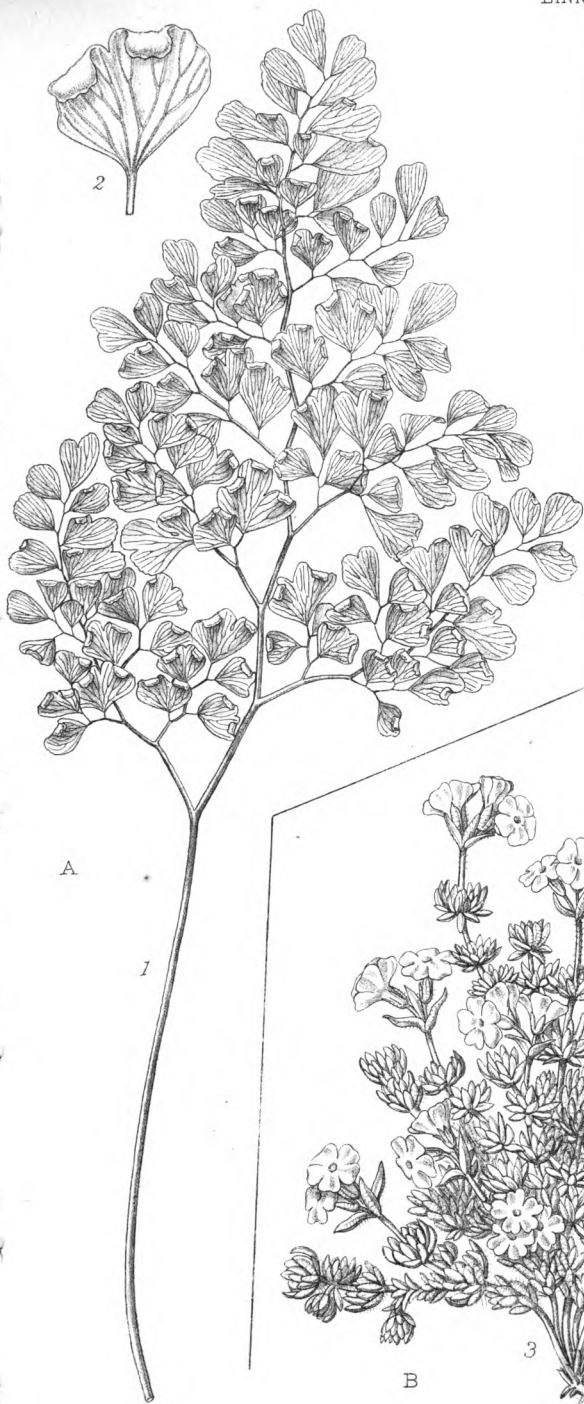

Australian Fungi.—II. Received principally from Baron F. von Mueller. By the Rev. M. J. BERKELEY, M.A., F.R.S., F.L.S.

[Continued from vol. xiii. p. 177.]

[Read November 18, 1880.]

236. *AGARICUS (AMANITA) VAGINATUS*, *Bull.* Herbert's Creek (*E. M. Bowman*); Rockhampton (*A. Thozet*).
237. *A. (COLLYBIA) LACCATINUS*, *Berk.* Cæspitosus, pileo plano-convexo pallide rufo-carneo glabro, margine sulcato; lamellis crassis paucis concoloribus; stipite pallidiore fibrilloso.
Moreton Bay. On dead wood amongst leaves. Has at first sight the appearance of a variety of *A. laccatus*.
238. *A. (OMPHALIA) GOMPHOMORPHUS*, *Berk.* Luridus, claviformis, pileo umbilicato; stipite sursum incrassato fibrilloso rufo, e mycelio candido fibrilloso oriundo; lamellis angustis.
On the ground in dense scrub. Rockhampton (*A. Thozet*). Pileus about $\frac{3}{4}$ inch across; stem $\frac{1}{4}$ inch high, 1 line thick, paler than the pileus. Allied to *A. fibula*.
239. *A. (PLEUROTUS) THOZETII*, *Berk. & Muell.* Pileo flabellato-lobato, e stipite radicante oriundo, ochroleuco; lamellis concoloribus latiusculis.
Pileus 3 inches across, about 2 long. Stem rooting amongst leaves, which are bound together by earth and mycelium. Sent originally by F. v. Mueller under the name of *A. Bowmani*.
240. *A. (FLAMMULA) SAPINEUS*, *Fr.* On rotten wood in dense scrub. Rockhampton (*Thozet*).
241. *A. (NAUCORIA) PEDIADES*, *Fr.* A large form.
242. *PAXILLUS CRASSUS*, *Fr.* Lamellis usque ad basin decurrentibus.
Rockhampton (*Thozet*). As I have no authentic specimen, it is uncertain whether this is identical with the species of Fries; but at any rate it is very near to it.
243. *RUSSULA SANGUINEA*, *Fr.* Burnett's River (*Watson*).
244. *MARASMIUS MUELLERI*, *B.* Cæspitosus; pileo umbilicato rugoso-sulcato subtiliter tomentoso fulvo; lamellis distantibus latiusculis ventricosis lignicoloribus adnatis, margine integris; stipite tenui basi dilatato pulverulento-tomentoso.
Herbert's Creek (*E. M. Bowman*). Pileus 1 inch across; stem 1 inch high, 1 line thick.
245. *M. EQUICRINIS*, *Muell.* Pileo parvo ex umbrino lacteo paucisulcato, e fibris sterilibus repentibus nigris, stipiti similibus oriundo.
Dalrymple Creek (*Lieut. Armitage*); Richmond River (*Mrs. Armitage*);

- and in various places, but seldom producing pilei. Nearly allied to *M. tomentillus*, which has very short stems. See 'Grevillea,' vol. viii. p. 153, where it is called *M. crinis equi*. I, however, follow the original name of Mueller.
246. *M. LIGNYODES*, Berk. Pileo convexo granulato sulcato; stipite nitido nigerrimo striato; lamellis latis ventricosis umbrinis.
On leaves of *Eucalyptus*. Allied to *M. rotula*.
247. *M. EXOCARPI*, Berk. Totus resupinatus albus, lamellis paucissimis, interstitiis latis lævibus.
Rockhampton (Thozet). On bark of *Exocarpus latifolius*.
248. *LENTINUS GUILFOYLEI*, Berk. & Muell. Pileo umbrino profunde umbilicato glabro, cuticula cartilaginea, margine sulcato; stipite curvato concolori striato; lamellis decurrentibus e sulco prope basin continuatis.
Pileus $2\frac{1}{2}$ –3 inches across; stem 2 inches high, $\frac{1}{8}$ inch thick.
249. *L. LATERITIUS*, Berk. Pileo convexo lateritio glaberrimo, margine involuto; stipite concolori rigido subæquali, lamellis albis erosio adnexis.
Pileus 1–2 inches across; stem 1 inch high, $\frac{3}{8}$ thick.
250. *PANUS TORULOSUS*, Fr. Moreton Bay (*J. M. Bailey*).
251. *P. ARENICOLA*, Berk. Brunneus, pileo e stipite brevitomentoso spatulato, margine inflexo; lamellis postice attenuatis fuscis.
Growing in very sandy soil; the stem and pileus both covered with adhering particles of sand.
252. *P. RIVULOSUS*, Berk. Pileo ochraceo striato-rivuloso umbilicato quandoque lobato; stipite excentrico striato-rivuloso demum umbrino, lamellis decurrentibus.
Pileus $2\frac{1}{2}$ inches across; stem short, $\frac{1}{2}$ inch thick. When old, it resembles *Paxillus crassus*.
253. *SCHIZOPHYLLUM MULTIFIDUM*, Fr. Moreton Bay (*J. M. Bailey*); Chatham Isles.
254. *BOLETUS THOZETII*, Berk. Flavus, pileo granulato-verrucoso; stipite gracili flexuoso; poris liberis.
On poor soil. Rockhampton (Thozet, no. 909). A single specimen. Pileus about $\frac{1}{2}$ an inch in diameter; stem $1\frac{1}{4}$ inch high, about $\frac{1}{8}$ thick. Clearly a distinct species, with a very unusual habit. There is a *Boletus* from Herbert's Creek gathered by E. M. Bowman, which is very like some European species, but which cannot be determined safely.
255. *POLYPORUS (MERISMA) SCABRIUSCULUS*, Berk. E stipite cylindrico biunciali repetite ramosus, ramis sexuncialibus; pileis spathulatis subtiliter pubescentibus scabriusculis; poris amplis.
Pores $\frac{1}{8}$ inch across. Forming a very large mass.

256. *P. (MERISMA) SULFUREUS*, *Fr.*
257. *P. (PLEUROPUS) PICIPES*, *Fr.*
258. *P. (PLACODERMEI) FERREUS*, *Berk.* Guilfoyle.
259. *P. (RESUPINATI) VAPORARIUS*, *Fr.* On a resupinate form of *P. ferreus*.
260. *DÆDALEA INTERMEDIA*, *Berk.* Dimidiata pallida zonata, antice e poris radiato-regulosa quandoque impressa; poris magnis hic illic elongatis.
Pileus $2\frac{1}{2}$ inches wide, $1\frac{1}{2}$ long; pores $\frac{1}{8}$ inch wide.
261. *MERULIUS AUREUS*, *Fr.* On rotten wood. Rockhampton (*Thozet*, no. 865).
262. *PHLEBIA CORIACEA*, *Berk.* Pileo spathulato coriaceo fusco, venis irregularibus.
On the ground. Rockhampton (*Thozet*, no. 853). Pileus $2\frac{1}{2}$ inches long, 1 inch across, in front spathulate, attenuated behind.
263. *GRANDINIA OCELLATA*, *Fr.* Chatham Islands.
264. *G. GRANULOSA*, *Nees*, var. *OCHRACEA*. Rockhampton (*Thozet*, no. 918).
265. *THELEPHORA CARYOPHYLLEA*, *Pers.* Burnett's River (*Watson*).
266. *STEREUM CAPERATUM*, *Berk. & Mont.* Tweed, Guilfoyle (*Schomburgk*); Moreton Bay (*J. M. Bailey*, no. 18).
267. *S. SPONGIÆPES*, *Berk.* Pileo infundibuliformi spongioso-tomentoso radiato-plicato-rugoso, margine fimbriato; stipite subæquali spongioso, hymenio ochroleuco radiato-rugoso.
Illawarra (*Johnson*). Pileus 2 inches across, $\frac{3}{4}$ inch high, densely spongy. Closely allied to *S. caperatum*, but the pileus is persistently spongioso-tomentose, and the spongy clothing of the stem is very different from that of the species just mentioned.
268. *STEREUM THOZETII*, *Berk.* Pileo infundibuliformi tomentoso demum radiato-striato subzonato pallido; hymenio rimoso ex albido castaneo polito.
Rockhampton (*Thozet*, no. 920). Pileus $\frac{1}{2}$ -1 inch across; stem $\frac{3}{8}$ inch high, attenuated downwards.
269. *S. LOBATUM*, *Kze.*, var. *RESUPINATUM*. Chatham Islands (*Johnson*, no. 720).
270. *PENIOPHORA DEGLUBENS*, *Berk.* Pallida, effusa crassa deglubens, extus tomentosa, hymenio velutino.
Herbert's Creek. A coarse species. Hymenium like that of *P. velutina*, Cooke.

271. *HYMENOCHÆTE RUBIGINOSA*, *Lev.* Illawarra (*Johnson*).
272. *AURICULARIA PUSIO*, *Berk.* Pileo postice adnato antice reflexo albo tomentoso rugoso, margine lobato; hymenio purpurascente.
On trunks of trees (*Thozet*, no. 869). A small but distinct species.
273. *CORTICIUM ANTHOCHROUM*, *Fr.* On *Casuarina equisetifolia*.
Rockhampton (*Thozet*, no. 910).
274. *C. VISCOSUM* (*Pers.*), var. *DEGLUBENS*. On very rotten wood (*Thozet*, no. 867). Adnate, with the margin peeling from the matrix.
275. *C. ARACHNOIDEUM*, *Berk.* On rotten wood 6 feet below the surface.
Rockhampton (*Thozet*, no. 929).
276. *CLAVARIA LÆTISSIMA*, *Pers.* Cæspitosa aurantiaca, repetite dichotoma compressa, apicibus dilatatis, subdivisis, fuscis.
South Queensland (*Hartman, Lockyer*, no. 477).
277. *HIRNEOLA RUFa*, *Berk.* Moreton Bay (*J. M. Bailey*, no. 1).
278. *H. LESUERII*, *Mont.* Moreton Bay (*J. M. Bailey*, no. 28).
279. *BATARREA PHALLOIDES*, *Pers.* Between Murchison's River and Shark Bay.
280. *GEASTER HYGROMETRICUS*, *Pers.* Rockhampton (*Thozet*, no. 907).
281. *G. LIGNICOLA*, *Berk.* Peridio exteriore tomentoso-granulato pallido, irregulariter rupto, interiore brunneo, ore fimbriato; capillitio fusco.
Rockhampton (*Thozet*, no. 908). *Thozet* describes the orifice, "teeth of the stellate orifice chestnut, with a tinge of rose when fresh." Nothing of this appears in the dried plant. Allied to *G. mirabilis*.
282. *TULOSTOMA MAMMOSUM*, *Fr.* Rockhampton (*Thozet*, no. 848).
283. *POLYSACCUM PISOCARPIUM*, *Nees.* Moreton Bay (*J. M. Bailey*, no. 30).
284. *P. TUBEROSUM*, *Mich.* Paramatta (*Woolfs*).

INODERMA, *Berk.*, n. gen.

Peridium suberosum, fragile, fibris repentibus ramosis omnino percursum, sporæ breviter fusiformes apiculatæ læves hyalinæ, floccis immixtæ.

This genus was formerly named *Mesophellia*; but the occurrence of a species with a very fragile peridium requires an alteration. The fibres are composed partly of cells, partly of very delicate threads like those of the capillitium.

285. *INODERMA ARENARIUM*, *Berk.* Peridium crassum, suberosum. In sandy ground, subterraneous. Harrietteville, Australia Felix. Two inches in diameter.
286. *I. INGRATISSIMUM*, *Berk.* Olidum, peridio crustaceo fragilissimo.
Near the river Goulbourn. Subglobose, about 1 inch in diameter;

flocci delicate, dirty white; spores shortly fusiform, spiculate at either extremity, .0004-.0005 inch in diameter. Odour extremely unpleasant. The spores and capillitium are the same as in the other species.

287. *PHALLUS WATSONI*, Berk. Volva tenui fragili, stipite elongato, capite conico rubro minute venoso, apice pervio.

Burnett's River (*Watson*). It looks at first like a *Cynophallus*, but the head is pervious. Head $\frac{5}{8}$ inch high, $\frac{1}{4}$ inch broad at base, stem $2\frac{1}{2}$ inches high.

288. *CYATHUS DESERTORUM*, Muell. Pallidus, tomentosus, intus glaber, lævis; sporangiis nigris; extus quandoque subtiliter sulcatus.

Darling River. On sand. Peridia about $\frac{1}{4}$ inch in diameter, $\frac{3}{8}$ inch high, including the root, which consists of matted fibres. Spores .0004-.0005 inch long, and nearly as wide.

289. *C. PUSIO*, Berk. Cyathiformis, albidus extus minute depresso-tomentosus, discis pallidis.

On the trunk of *Eucalyptus hemiphylæodes*. Rockhampton, no. 793. A very neat little species; spores .0003 inch long.

290. *C. FIMICOLA*, Berk. Cupulæformis, umbrinus, discis concoloribus.

On dung (*Thozet*, no. 859). The whole plant within and without umber, spores .0004-.0005 inch long, narrow.

291. *C. PEZIZOIDES*, Berk. Cupulæformis, extus dense tomentosus, umbrinus.

On decaying herbaceous plants (*Thozet*, no. 856). Unfortunately there are no disks, but the species is clearly distinct.

292. *ÆTHALIUM SEPTICUM*, Fr. On decomposing Bananas. Rockhampton (*Thozet*, no. 847). "Base orange-yellow, cap nankin."

293. *CHONDRIODERMA SPUMARIOIDES*, Rostaf. On roots of reed-like grasses. Rockhampton (*Thozet*, no. 796).

294. *CLATHROPTYCHIUM RUGULOSUM*, Wallr. Moreton Bay (*J. M. Bailey*, no. 9).

295. *TILMADOCHÉ MUTABILIS*, Rostaf. On rotten trunks of *Eucalyptus*. Rockhampton, no. 916-930 (*Thozet*).

296. *ARCYRIA FERRUGINEA*, Rostaf. On decayed *Eucalyptus*. Rockhampton (*Thozet*, no. 922).

297. *A. NUTANS*, Fr. Rockhampton (*Thozet*, no. 923). A very pale variety.

298. *STEMONITIS FERRUGINEA*, Ehrenb. Moreton Bay (*J. M. Bailey*, no. 29).

299. *TUBULINA NITIDISSIMA*, Berk. Peridiis nitidissimis aureis, sporis pallidis globosis.

On decayed *Eucalyptus microtheca* (*Thozet*, no. 913).

300. *THECAPHORA LEPTOCARPI*, Berk. Sporis e granis globosis decem consistentibus.

On *Leptocarpus tenax*. Wilson's Promontory. Grains larger than in *T. occulta*.

301. *ISARIA FUCIFORMIS*, Berk. A bright-coloured form, extremely injurious to crops of *Lolium perenne*. The specimens first described were supposed to spring from some germinating grass. This has occurred lately in Sussex.

302. *CERATIUM HYDNOIDEUM*, Alb. & Schw. Rockhampton, on *Eucalyptus* (Thozet, no. 849-849 bis).

303. *NEMATOGONUM AUREUM*, Desm. On decayed bark of *Maba obovata* (Thozet, no. 931).

THOZETIA, Berk. & Muell., n. gen.

Sporodochium minutum globosum; sporæ hyalinæ oblongæ utrinque seta unica terminatæ.

304. *T. NIVEA*, Berk. On dead wood. Snow-white, hyaline spores oblong, pointed at either end, and terminated with a single long bristle.

305. *PSILONIA NIVEA*, Fr. On bark of *Careya arborea*. Rockhampton (Thozet, no. 904). This, like the common production on beech produced by *Adelges Fagi*, is not a true fungus; but as it has been so recorded by Fries, it is thought fit to mention its occurrence here. It arises probably from a different insect.

306. *CLADOSPORIUM STENOSPORUM*, Berk. On leaves of *Acacia Lebbek*. Rockhampton (Thozet, no. 928).

307. *MYLITTA AUSTRALIS*, Berk. Illawarra (Johnson). A small form, scarcely exceeding an inch in diameter.

PHILLIPSIA, Berk., n. gen.

Contextus lentus, cupulæ amplæ disciformes marginatæ, hymenium semper apertum.

To this genus belong *Peziza domingensis*, Berk., *P. Venezuelæ*, Berk. & Cush., *P. Wynniæ*, Berk., *P. inæqualis*, Berk., *P. hirneoloides*, Berk., and *P. emarginata*, Berk., of which the penultimate is Australian.

308. *PHILLIPSIA POLYPOROIDES*, Berk. Effusa adnata crassa carnea, hymenio purpureo.

On dead stems of *Vitis*. Rockhampton (Thozet, no. 852). Cups more than an inch across; sporidia elliptic, binucleate, .0012-.0013 inch long.

309. *PEZIZA THOZETII*, Berk. Pateriformis, brunnea carnea, ascis gracilibus longissimis, sporidiis uniseriatis ellipticis utrinque papilla terminatis dein minutissime granulatis.

On *Nepenthes* (Thozet, no. 934).

310. *ASCOBOLUS AUSTRALIS*, Berk. Brunneus, ascis clavatis, sporidiis ellipticis purpureo-fuscis lævibus, paraphysibus linearibus apice latioribus. On dung. Rockhampton (*Thozet*, no 851). Sporidia '021-'028 inch long.
311. *XYLARIA HYPOXYLON* (*Ehrenb.*), var. *BOWMANI* (*Muel.*). *Gracilis brevis*. On dead wood, King's Creek. Very slender, $\frac{3}{4}$ inch long, or more rarely 1 inch, about $\frac{1}{4}$ inch thick. Perithecia not sufficiently advanced to show the nature of the sporidia.
312. *SPHÆRIA SCHOMBURGKII*, Berk. Peritheciis magnis liberis, ostiolo lineari, sporidiis elongatis biconicis. A large and beautiful species; sporidia '0013 inch long, fusiform, with a single septum.
313. *SPHÆROSTILBE DUBIA*, Berk. On the bark of *Ægiceras majus*. Rockhampton (*Thozet*, no. 747). This is only in the *Stilbum* state; it is clearly distinct, but no character can be given without the ascigerous form.

I take this opportunity of calling attention to a little understood species of Sowerby, which, indeed, has been entirely neglected by Fries, except so far as a note in the index to the third volume of the 'Systema,' where it is said to be allied to *Coprinus domesticus*, and is not included in the latest list of British species of Fungi. The species in question is *Agaricus acetabulosus*, Sow. t. 303, an allied form having been found by Mr. Drummond at the Swan River. The original specimen is still in existence, attached to the drawing from which the plate was made; and it is clear that it is no *Coprinus*, but is quite as distinct from that as is *Bolbitius*. It must form a separate section in Dermini, which may be called *Acetabularia*, analogous to *Volvaria* and *Chitonina*, and of which there will be two species.

Velum universaliter a pileo discretum; hymenophorum discretum; lamellæ liberæ; sporæ pallide fulvæ v. brunneæ.

1. *AGARICUS* (*ACETABULARIA*) *ACETABULOSUS*, Sow. t. 303. Lamellis hispidis.
2. *A. CYCNOTAMIA*, Berk. Lamellis pallide cervinis lævibus, stipite corneo.

Sent by Mr. Drummond from the Swan River, where it is said to be very rare. Pileus $\frac{3}{4}$ inch in diameter, stem $1\frac{1}{4}$ inch high, about a line thick. Gills leaving a free space round the top of the stem; spores '0003-'0004 inch in diameter. Volva composed of intricate threads, with a central dark patch, which appears to contain spiral vessels, but the materials are so scanty that it is impossible to speak with certainty. Attached to the specimen is a species of *Arachnion*, Schwein. (the spores are globose and '0002-'0003 inch in diameter), which may be called *A. Drummondii*, Berk.

NOVITATES CAPENSES: Descriptions of New Plants from the
Cape of Good Hope. By P. MACOWAN, Esq., B.A., and
H. BOLUS, Esq., F.L.S.

[Read November 18, 1880.]

RANUNCULUS (§HECATORIA) BAURII, *MacOw.*, n. sp.—Caulo solitario, nudo, glabro, 1-3-cephalo; foliis radicalibus longe petiolatis peltatis glabris crenatis, subtus pallidis venosis; calyce glabro; petalis luteis anguste obovatis, basi attenuatis, fovea nuda; carpellis oblique ovatis subcarinatis, rugis prominulis anastomosantibus notatis, rostro brevi uncinato.

Collum breve incrassatum. Radices plures carnosæ 2-3-pollicares, 8 millim. crassæ. Caulis 3·50-4·50 decim. longus, glaber. Folia omnia radicalia orbiculata peltata, 2·50-5·00 centim. diam., supra saturate viridia, subtus pallidiora venosa; petiolis 1·25-1·50 decim. longis, striatis. Flores lutei, 1·75 centim. lati. Inflorescentia tum e 2-3 pedunculis pseudo-paniculata quum terminalis monocephala; bracteis ovatis, grosse dentatis. (*v. s. s.*)

Hab. In graminosis subhumidis summi montis Bazija in Terra Kaffrorum (Ngangelizwe), alt. 4000 ped.; legit Rev. R. Baur.

Ranunculus is but scantily represented in South Africa. The discovery of this very distinct species, by the persevering labours of the collector whose name it bears, adds one more to the two previously known endemic representatives of the genus. The material to hand, though ample for description, is much injured by insects; hence the publication of a figure, though very desirable, is deferred for the present. Among some fragments from Cooper's collections I recognize a leaf belonging to this plant. Although in every other respect conformable, it is fully 3 inches in diameter. Hence the specimens sent by Mr. Baur hardly represent the maximum size of the plant*.

* [Specimens are in the Kew Herbarium from Basuto-land, collected by Mr. Cooper, with leaves varying from 4-5 in. diam., and inflorescence a lax corymbose cyme of 10 or more flowers; also from Vaal River (radical leaves), Dr. Sutherland, and Transvaal (Steen-kampsberg), Mr. Nelson. In Mr. Cooper's specimens the petals are numerous, about 13-17, oblong-ob lanceolate, and the flowers nearly $\frac{1}{2}$ inch diam. Excepting in the narrow petals, this plant seems nearly allied to *R. Lyallii*, Hook. f., of New Zealand, in which species, however, the flowers are white.—D. OLIVER.]

CRASSULA DEPENDENS, Bolus, n. sp.—Ramis divaricatis, filiformibus, procumbentibus; foliis subulatis utrinque subplanis; cymis paucifloris, pedunculis abbreviatis.

Hab. In clivis umbrosis montis "Cave" prope Graaff Reinet, in regione editiore Colonix Capensis, alt. 3700 ped., flor. Febr.; legit H. Bolus (No. 658).

Planta debilis, subherbacea, glaberrima, forte annua. Caules late effusi sæpe dependentes. Folia connata, decussata, acuta, 8 millim. longa, 3 millim. lata; internodiis inferioribus, foliis brevioribus, superioribus longioribus. Cymæ terminales, breviter pedunculatæ, sæpius 7-floræ. Flores basi bibracteolati, pedicellati. Calycis lobi ovati, obtusi, $1\frac{1}{2}$ millim. longi, integri. Petala oblonga, acuta, basi connata, 5 millim. longa. Styli filiformes, divergentes, 2 millim. longi. Squamæ cuneatæ, truncatæ, minutæ, aurantiacæ. (v. v.)

This well-marked species comes nearest to *C. acutifolia*, Lam., var. *radicans*, but differs by its flattened leaves and much weaker, straggling, dependent habit. It may be identical with *C. bibracteata*, Harv., or *C. filicaulis*, Haw., quoted by DeCandolle in the 'Prodromus,' iii. 384. But no specimens were seen by him, nor by Harvey, by whom the genus has been most recently revised in the 'Flora Capensis,' vol. ii.; and there are probably none extant. I am assured that there is nothing from previous collectors, either in the Kew Herbarium or in the rich Cape collection of Dr. Sonder of Hamburg, identical with the present plant. It seems useless to maintain names of species published with such brief characters that their identification by such means is now impossible, or of which dried specimens have not been preserved.

ATHRIXIA (§*ASTEROPSIS*) *FONTANA*, MacOw., n. sp.—Caule simplici pedunculoideo monocephalo; foliis radicalibus rosulato-confertis, ovato-lanceolatis, caulinis multo angustioribus, sursum decrescentibus; squamis involueralibus basi margineque tomentosis, in pedunculo effusis.

Herba perennis, stolonifer. Caulis simplex scapiformis, 1-cephalus, araneosus demum subglabrescens. Folia radicalia conferta squarrosa subrosulata ovato-lanceolata acutiuscula integerrima, margine leviter revoluta, supra glabra, subtus, nervo excepto, albo-tomentosa; caulina parva alterna decurrentia, sursum in squamis depauperascentia. Capitula solitaria, diametro 1.20 centim.; squamis multiseriatis linearibus squarrosis rufis,

margine leviter et basi dense tomentosus, plus minus in pedunculo effusus. Ligulæ 20, supra albæ, subtus rosæ; flores disci circiter 50. Pappus dimorphus, e squamis brevibus serrulatis, cum setis barbellatis, 2 millim. longis, alternantibus. (v. v.)

Hab. In scaturiginibus summi montis Boschberg, in ditione Somerset, C.B.S., alt. 4800 ped., Jan.–Feb.; MacOwan legit (No. 1995, *distrib. ann.* 1871 *et seq.*).

This plant presents a remarkable deviation from the habit, foliage, and station affected by other *Athrix*æ. It grows with *Utricularia capensis*, Spr., *Anagallis Huttoni*, Harv., and the like, often deeply immersed among *Confer*væ.

SENECIO (§ RIGIDI) TRULLÆFOLIUS, *MacOw.*, n. sp.—Caule erecto, herbaceo glabro sulcato; foliis radicalibus pluribus, longe petiolatis subovatis obtusis, basi abrupte ac oblique cordatis glabris; caulinis sessilibus e basi semiamplexicauli lanceolatis; corymbo laxo; capitulis subquiniis, radiatis, basi 1-bracteatis, squamis involucralibus angustis subconcretis.

Radix perennis, e fibris multis fasciculatis. Caulis 1½–2-pedalis erectus glaber sulcatus. Folia radicalia pluria, plus minus triangulari-ovata v. trullæformia, basi abrupta, glabra, sinuato-dentata, 7·0–8·5 centim. longa, 2·40 centim. lata; petiolis supra sulcatis, 9·5–12·0 centim. longis; caulinia lanceolata in basin latiore semiamplexicaulem auriculatam expansa. Inflorescentia corymboso-paniculata laxa, e ramis primordialibus sub 4nis in pedicellis 2–4, basi et juxta apicem bracteatis abeuntibus. Capitula diam. 6 millim. radiata, squamis involucralibus subduodenis, ultra dimidiam partem concretis, disco brevioribus. Flores disci 30, radii 5–7, ligulis 1 centim. longis, læte luteis. (v. v.)

Hab. In saxosis præcipitibus summi montis Boschberg, in ditione Somerset, C.B.S., alt. 4800 ped., Jan.–Feb.; MacOwan legit (No. 1902, *in distrib. ann.* 1872 *et seq.*, *sub nomine* *S. rumicifolio*, *MS.*).

With the above, and under No. 1730, was distributed a curious *Senecio*, with capitula resembling those of *S. asperulus*, DC., and foliage like entire-leaved forms of *S. erosus*, Linn. f. A provisional MS. name (*S. prionites*, MacOw.) was appended; but without collation with Dr. Sonder's *S. serratus* (*S. leontodontis*, DC.), of which there does not appear to be types in herb. Kew, it would be unwise to publish it. The plant taken by us for *S. serratus*, Sond., and distributed under No. 1659, herb. MacOw., is a variety of *S. incomptus*, DC., on the testimony of Dr. Sonder himself.

GAZANIA CÆSPITOSA, Bolus, n. sp.—Foliis crebre imbricatis, linearibus, basi latis semiamplexicaulibus, margine stricte revolutis, biserialim callosa-setosis; involuero oblongo-campanulato, glabro, basi intruso; lobis e basi lata subulatis, 3–4-serialibus, externis brevioribus ciliatis, mediis longioribus acuminatis, intimis glabris membranaceis integris.

In summo monte Koudveld, Sneeuwbergen, in regione editiore Coloniae Capensis, alt. 5500 ped., flor. Dec.; legit H. Bolus (No. 2578).

Dense cæspitosa, caule multicipiti lignoso, foliis obtecto. Folia pallide virescentia superne glabra, subtus dense tomentosa, spinoso-mucronata, 2.0–2.40 centim. longa, 2–3 millim. lata. Pedunculi foliis paulo longiores, inferne tomentosi sursum glabri. Involucria 1.0–1.20 centim. longa, tubo 5 millim. longo. Ligulæ 10–12, luteæ, dorso fasciatæ, 1.20–1.60 centim. longæ. Pappi paleæ lanceolato-acuminatæ. Achenia villis badiis obtecta corollæ tubo subæquilongis. (v. v.)

ERICINELLA PASSERINOIDES, Bolus, n. sp.—Foliis ovato-oblongis erecto-adpressis, imbricatis, leviter pubescentibus; sepalis omnibus inæqualibus oblongis; superioribus apice subfoliaceis, corolla parum brevioribus; antheris inclusis scabris, aristatis; ovariis 3-loculatis albo-sericeis.

In clivis montosis, Koudveld Mt., Sneeuwbergen, in regione editiore Coloniae Capensis, alt. 5000 ped., flor. Dec.; legit H. Bolus (No. 2582).

Fruticulus erectus, ramosus, bipedalis; ramulis junioribus pubescentibus, demum glabris. Folia crebre imbricata, 1½ millim. longa. Flores 4–5, longiuscule pedicellati, demum cernui. Corolla 2 millim. longa, lobis oblongis, late obtusis, carneis. Stylus validus, exsertus. (v. v.)

It cannot be too clearly understood that the *Ericæ*, generally regarded as characteristic of "the Cape," are really almost entirely restricted to a narrow belt of land along the southern coast. The present plant is interesting as being one of a very few stragglers into the interior, beyond the intervening Karoo plains, occupying stations of high altitude exclusively on the loftier mountain-ranges. The altitude of such outliers would appear to increase as we proceed northward towards the equator, until at Kilima Njaro, in lat. 3° 5' S., two species (a *Bleria* and an *Ericinella*) were found by the Rev. Mr. New, just under the snow-line, at an elevation of 15,000 or 16,000 feet.

ORTHOSIPHON AMBIGUUS, *Bolus*, n. sp.—Caulibus adscendenti-bus, simplicibus vel basi trichotome ramosus; foliis longe petiolatis, ovatis, grosse dentatis, basi integris cuneatis, floralibus sessilibus; racemis abbreviatis, confertis; calyce intus nudo; corolla calyce 4plo longiore, tubo leviter incurvo, fauce æquali, genitalibus exsertis; stylo apice breviter bifido, lobis subæqualibus subulatis (*nec ut in congeneribus* “*clavato-capitato vel obtuso, integro vel leviter emarginato*”).

In sylvis montium prope Grahamstown, in regione orientali Coloniae Capensis, alt. 2000 ped.; legit P. MacOwan (No. 987).

Planta gracilis vix pedalis, caulibus subherbaceis; ramis, petiolis, nervisque foliorum pilis articulatis pubescentibus. Folia subpollicaria, supra pilis sparsis hispidula, petiolis æquilonga; floralia infima conformia subsessilia, suprema bractæformia minuta integra. Verticillastri 4–6-flori, in racemum brevem vix pollicarem conferti. Pedicelli 4 millim. longi. Calyx 5 millim. longus, tubo brevi pubescente, dentibus coloratis, supremo vix decurrente, inferioribus subulato-acuminatis inter se subæquilongis; fructifer deest. Corolla tubo gracillimo, 2 centim. longo, tenuiter pubescente, labium superius 4-fidum, inferius brevior concavum, dilute cærulea. Nuculæ desunt. (*v. s. s.*)

This interesting plant, kindly sent to me by my friend, Prof. MacOwan, has all the characters of *Orthosiphon*, excepting that of the style, which is here not at all thickened or expanded, but is divided at the apex into subulate branches, exactly as in *Plectranthus* or *Hyptis*. I have here only access to descriptions and to a single figure, that of *O. rubicundus*, Benth. (Hook. Ic. Plant. t. 459), from the style of which this widely differs. But *O. diffusus*, Benth., is characterized as having merely “stylus obtusus demum breviter bifidus;” and that may afford a transition to the present species, where the style is bifid with subulate lobes. It differs also from its congeners by its remarkably abbreviated raceme. The divergences, however, from any other of the Ocimoid genera seem to be greater; and I venture to place it here for the present.

DIPCADI BAKERIANUM, *Bolus*, n. sp.—Folia 3–4, carnosoherbacea, glabra, lanceolato-acuminata, leviter striata, 14–17 centim. longa, 2.0–2.40 centim. lata. Scapus teres, 15–20 centim. longus. Racemus laxè 8–10-florus. Pedicelli infimi, 4–6 millim. longi. Bractæ ovato-acuminatæ, membranacæ, 5-nervatæ, diu persis-

tentes, 6 millim. longæ. Perianthium viridi-flavescens, 1·6–2·0 centim. longum, tubo 5–6 millim. crasso; segmentis interioribus tubo subbrevioribus, exterioribus 2 millim. longioribus. Filamenta ad faucem inserta, dilatata, antheris parum breviora. Capsula sessilis, 1·40 centim. longa et lata; seminibus in quoque loculo 18–20. (*v. v.*)

In planitie prope pagum Murraysburg, in regione editiore Colonie Capensis, alt. 3800 ped., flor. Febr.; legit H. Bolus (No. 2059).

A species distinguished from most of its congeners by its broadly lanceolate leaves. *D. glaucum*, Baker, which has broadly ligulate leaves, is a very different plant.

URGINEA ALOOIDES, *Bolus*, n. sp.—Bulbus.....? Folia (teste beato collectore) “plura, lorata, bipedalia, carnosio-herbacea, apice laxè reflexa.” Scapus teres erectus validus, 2–3-pedalis, 1·25–1·50 centim. crassus. Spica stricta crebre pluriflora, 3–4 decim. longa, 2·0–2·40 centim. lata. Bracteæ oblongæ cuspidatæ, 6–8 millim. longæ. Perianthium 6–8 millim. longum, sordide flavescens; segmentis oblongo-lanceolatis, 3–4 millim. latis, dorso distincte viridi-vittatis, 3-nervatis. Stamina hypogyna, perianthio æquilonga; filamentis dilatatis alternis latioribus. Stylus filiformis firmus exsertus, 7–8 millim. longus, sæpius declinatus, ovario 1½–2plo longior. Ovarium oblongum, 5 millim. longum. Semina in loculis pauca subcompressa. (*v. s. s.*)

Hab. In clivis montosis Drakensbergen, prope Macamac, in Colonia Trans-Vaal, alt. circ. 5000 ped., flor. Junio; legit J. H. MacLea, anno 1875. (Herb. propr. No. 3011.)

A remarkable species, with the aspect of an Aloe. It is readily distinguished by its long and densely-flowered spike. I have only seen the flowering scapes; but the leaves were described to me by the late Mr. MacLea, an energetic collector in the region indicated.

HERPOLIRION (§ DICARPÆA, seminibus in loculis geminis collateralibus erectis).

H. CAPENSE, *Bolus*, n. sp.—Herba perennis acaulis graminioidea glabra cæspitosa bipollicaris. Rhizoma gracile repens stoloniferum; flagellis hypogæis filiformibus. Folia linearia congesta rigida, basi membranacea scapum arcte cingentia, sursum complicata, dorso crebre nervata, acumine calloso desinentia, flores

parum superantia, 1-2 centim. longa, 2 millim. lata. Scapus subnullus filiformis umbellatus, 1-2- vel rarius 3-florus. Bracteæ foliis subconformes, basi vaginantes, vetustiores 8-10 millim. longæ. Pedicelli floriferi ascendentes subcarnosi flavi, fructiferi decurvati indurantes diu persistentes, 6-8 millim. longi (apice articulati?). Perianthium pallide cæruleum, apice purpureo-suffusum; segmentis oblanceolatis subconformibus, medio tantum leviter 3-nervatis, 6 millim. longis, 3 millim. latis, post anthesin spiraliter contortis. Stamina inclusa, 3 exteriora profunde perigyna, 3 interiora hypogyna breviora, filamentis dilatatis lanceolatis luteis, antheris ovatis obtusis. Ovarium semiovatum, stigmatate punctiformi, stamina breviora æquante. Capsula subglobosa leviter 3-lobata, 5 millim. longa et lata, loculicide dehiscens, seminibus in loculis geminis collateralibus erectis translucen-
tibus. (v. v.)

Hab. In saxoso cacumine inferioris e duobus montibus "Winterhok" dictis, prope Tulbagh, in regione austro-occidentali Coloniae Capensis, alt. circa 6500 ped., flor. Nov.; legit H. Bolus (No. 5170).

I know of no Cape plant to which this interesting little species is allied. In habit it reminds one of a prostrate *Wahlenbergia* or of *Roella muscosa*. Structurally it is nearest to *Herpolirion*, hitherto known only from Australasia. The differences are chiefly in the two erect collateral seeds of each cell of the capsule, and in the spiral twisting of the withered perianth, a character not always clearly exhibited. On turning to the beautiful figure of *H. Tasmaniae*, Hook. f., in Sir J. D. Hooker's 'Flora of Tasmania,' tab. 132, the structure and general habit are seen to be so strikingly similar that I can hardly doubt the propriety of regarding it as a Cape representative of that genus. If this be correct, the generic character of *Herpolirion* must be modified to admit it. I have never met with the plant elsewhere than on the mountain above named; and the peak, which is not very easy of access, has probably been seldom if ever visited by collectors.

GETHYLLIS (§ CLINOSTYLIS) LONGISTYLA, *Bolus*, n. sp.—*G.* foliis squamoso-strigosis, rectis; corollæ tubo longo gracillimo; stylo longe exserto declinato.

Bulbus ovatus vel ovato-rotundus, squamis exterioribus solutis, tunicis interioribus in collo longo productis, pallide rubris. Folia 12-18, hysternthia, e basi lata linearia, interdum involuta,

setaceo-acuminata, ciliata, squamis albis linearibus laceratis centricifixis obtecta, 0·75–1 decim. longa, 6 millim. lata. Flos solitarius, e spatha membranacea bifida hypogæa, hypocrateriformis, tubo leviter incurva striatulo, 5 centim. longo, limbi laciniis patentibus lineari-lanceolatis acuminatis, 2–2½ centim. longis, 5–6 millim. latis. Filamenta monantherifera, 4 millim. longa; antheris biloculatis sagittatis, 6 millim. longis. Stylus validus, subangulatus, pars inferior gradatim incrassata, parte exserta 6–8 lin. longa; stigmatibus capitato, obscure trilobo. Ovarium obovatum vel clavatum? (vix visum). Fructus ignotus. (*v. s. s.*)

In locis lapidosis apertisque inter Murraysburg et Richmond, alt. circ. 4000 ped., similibusque montium [Sneeuwbergen, in regione editiore Colonix Capensis; legit W. Tyson, anno 1878. (No. 842, Herb. Bolus.)

The long, exserted, and declined style constitutes in this plant a marked departure from the type of the genus, so far as the species are known to me or characterized in Kunth's 'Enumeratio.' Nor does Mr. Baker's very recent revision of the genera of this Order (Trimen's Journ. Bot. vol. vii. n. s. p. 161) refer to any such peculiarity. The fruit is as yet unknown; but in other respects the present plant so much resembles *Gethyllis* that I propose to place it here until the fruit shall be seen, under the section *Clinostylis*, as distinct from section *Orthostylis*, to include the species with a straight and comparatively short style. The plant occurs in several parts of the Sneeuwberg mountains, but apparently flowers rarely; for though I have several times seen and gathered it in leaf, and also sent bulbs to Kew some years ago, I was never fortunate enough to find it in flower. I received the specimen from which the above description is drawn from Mr. W. Tyson, of Murraysburg, who has already detected several novelties in that region. It was the only flowering specimen he met with.

On an *Erythræa* new to England, from the Isle of Wight and South Coast. By FREDERICK TOWNSEND, M.A., F.L.S.

[Read December 2, 1880.]

(PLATE XV.)

IN the 'Journal of Botany' for October 1879 I drew attention to an *Erythræa* which I had lately found on the downs of Freshwater in the Isle of Wight, and to which at that time I was unable to give a name, though inclined to think it might be *Erythræa capitata*, Willd. I hesitated to refer it to that species, because my plant differed in some respects from the longer description given by Rœmer and Schultes in their 'Systema Vegetabilium,' and I was unacquainted with Willdenow's plant either in the living or dried state.

On first gathering the *Erythræa* in the island, I was much struck with its habitual dwarf character, in which it approached a dwarf and capitate variety of *Erythræa Centaurium*, which also grew abundantly in the same locality. I soon found it easy to distinguish the former by its narrower leaves, by the shortness of its corolla-tube, and, above all, by its almost free stamens, the filaments of which, without exception, I found to be attached only at the base of the corolla-tube, and to be otherwise perfectly free within it (compare fig. 3 *b* and fig. 6). This latter character seemed to have been hitherto unobserved in any species of the genus *Erythræa*; and indeed it would take the plant out of the genus, as described by Grisebach in his monograph of the order Gentianaceæ, given in the 'Prodromus' of De Candolle, where he says "*Stamina 5-4, corollæ tubo superiore inserta*" (DC. Prod. ix. p. 57).

It has been suggested to me both by Dr. Syme and Dr. Ascherson that the comparatively free stamens might represent a tendency to, or "the last remains of," dimorphism, like *Menyanthes* and *Limnanthemum* in the same order, or like *Primula* &c.; and if this were the only character by which the plants could be distinguished, or that a similar tendency could be traced in other species of the genus, I should myself be disposed to give some weight to the suggestion; I have, however, carefully searched for other examples in the same genus, and have examined numerous specimens, especially of the following species, *E. Centaurium*, *E. pulchella*, and *E. littoralis* (*E. linarifolia*, Pers.), in all of which I

have invariably found the filaments attached at or near the throat of the corolla, and of comparatively equal length, whilst, as already observed, I do not know an instance in which the filaments are so attached in the Freshwater plant

Through the kindness of Dr. Ascherson, I have lately been able to examine an authentic specimen of *Erythræa capitata*, Willd., from the Berlin Herbarium. In this specimen I find the filaments are likewise attached only at the base of the corolla-tube; and having asked Dr. Ascherson to examine specimens with especial regard to the insertion of the filaments, he informs me that the Berlin specimens agree in this curious character and also in general habit. I have not been able to consult other specimens myself, and cannot find that any of true *E. capitata*, Willd., exist except in the Berlin Herbarium.

The earliest record of *E. capitata* is that given by Chamisso in his 'Adnotationes quædam ad Floram Berolinensem, auctore Adalbert de Chamisso' (1815), 8vo, 13 pp. These 'Adnotationes' are found in an appendix to a third edition of a catalogue published anonymously, the author of which is F. Walter (chief gardener of Frau von Friedland and Count Itzenplik), who died in 1865. The title of the catalogue is 'Verzeichniss der auf den friedländischen Gütern cultivirten Gewächse, nebst einem Beitrage zur Flora der Mittelmark,' and the first edition was edited by Willdenow. The third edition appeared in 1806. Chamisso's notice of *E. capitata* runs thus:—" *Erythræa capitata*, foliis elliptico-lanceolatis obovatisque tri- et quinque nervibus sessilibus, floribus capitatis bracteatis.—Willd." "Species notabilis, inedita, ex herb. celeberrimi viri. Planta semel sed copiose a phytopola adlata rursus haud reperta est. Latet locus natalis"* (p. 9).

The original MS. of Willdenow's short diagnosis printed by Chamisso seems to be lost; the plant is also wanting in Willdenow's herbarium, as the specimens preserved at Berlin belong to the "Herbarium Generale," which, together with a small number of plants, probably found after the death of Willdenow, had not been placed in his herbarium. Dr. Ascherson thinks it probable that the label accompanying the specimens was written by Schlechtendal pater, who took care of his friend

* I am indebted to Dr. Ascherson for this extract from Chamisso's 'Adnotationes,' no copy of which could I find in the English libraries.

Willdenow's herbarium, and sent to Schultes many observations and notes on 'Reliquiæ Willdenowianæ.' Rømer and Schultes are therefore hardly correct in writing "Herb. Willd.," as they do in their notice of the plant in their 'Syst. Veg.' Dr. Ascherson also thinks it nearly certain that Schlechtendal pater was the author of the longer description given by Rømer and Schultes, which is as follows:—"Caulis 2 poll., simplex, basi dense tectus foliis obovatis lanceolatis. . . foliis binis ternisve cincto. Bracteæ lineares acutæ, floribus intermixtæ. Calycis lacinie acutæ longitudine tubi. Corolla *Centaurei* sed lacinie acutiores, angustiores. Caulis sæpe in superiore parte, immo ad ipsum capitulum, ramum unum alterumve emittit nudiusculum capitulo terminatum ut planta prolifera videatur."—*R. & S., Syst. Veg.* vol. iv. p. 786 (1819).

From want of access to specimens since Willdenow's time, subsequent authors have unfortunately confounded his *E. capitata* with a capitate variety of *E. Centaurium*. In no instance, in any of the extracts I am about to give, are distinctive characters given by which either Willdenow's plant or that from Freshwater (both of which I refer to one and the same species) can be distinguished from a very different plant, viz. a capitate variety of *E. Centaurium*. It is certain that some of the extracts refer only to the latter variety.

"*E. Centaurium* . . . variat β . *capitata* corymbo etiam post anthesin compacto, nec elongato: *E. capitata*, R. et S. *Syst. Veg.* iv. 163, D. fl. 2, p. 132. In Westph. u. Brandenb."—*Koch, Synop.* ed. 2, p. 566. "*E. Centaurium* . . . γ . *capitata* caule abbreviato, corymbo capitulo-contracto: *E. capitata*, Cham."—*Bluff & Fingerhuth*, ed. 2, vol. i. p. 391*. "*E. Centaurium* . . . aut caule abbreviato floribus dense capitatis: *E. capitata*, Chamiss."—*Reich. Fl. exc.* p. 433. "Specimina suecica [of *E. Centaurium*] ad illam formam, quæ *E. capitata*, Røem. & Schult. iv. p. 108, pertinent."—*Fries, Novitiæ*, ed. 2, p. 72. "*Erythræa Centaurium*, β . *capitata* (R. & S.) *fasciculata*, Selm.": "Fl. nombreuses réunies en corymbe serré, compacte même apres la fleuraison. Coteaux maritimes: Granville, Cherbourg, Carteret."—*Brébisson, Fl. de Normandie*, ed. 4, p. 201. "*E. Centaurii* forma abbreviata, *E. latifolia* subsimilis, at pecorum dentibus orta."—*Grisebach, Gen-*

* The author quotes G. L. E. Schmidt's work entitled 'De Erythræa Dissertatio inauguralis,' in which *E. capitata*, Cham., is given as one of nine named varieties of *E. Centaurium*. Five of the varieties are figured, but *E. capitata* is not one of the number.

tian. p. 140. "*E. Centaurium* . . . var. γ . *E. capitata*, Cham.: Der Stengel ist vom Grunde an stärker geflügelt-kantig als an der Stammart; die Doldentraube bleibt auch bei der Fruchtreife sehr gedrunge, indem die Aestchen sich kaum verlängern; der Kelch ist bei der geöffneten Blüthe meist um die Hälfte kürzer als die Röhre, und bei der Fruchtreife fast um das Dreifache kürzer als diese. Die Blume wie bei der Stammart . . . die Abart γ . im Pastoreiholze bei Lübke in Westphalen von Dr. Weihe gesammelt und mitgetheilt, auch haben wir sie von Dr. Wickström aus Schweden als *E. Centaurium* erhalten."—*Mertens & Koch*, in *Röhl. Deutsch. Fl.*, ii. p. 233. "*E. Centaurium*, Pers. . . β . *E. capitata*, Rœm. Plante courte, ramassée, à corymbe toujours compacte; feuil. rad. nombreuses, grandes, arrondies, obtuses, à 5–7 nervures. Rochers, pelouses sablonneuses, graviers de la région maritime, surtout de la côte du nord."—*Lloyd*, *Fl. de l'ouest de la Fr.*, ed. 3, p. 204. "*Erythræa Centaurium*, L., var. *capitata*, Rœm. et Sch. On Freshwater Down and in the warren at Alum Bay, plentifully"*.—*A. G. More*, *Supp. to the Fl. Vectensis in Journ. of Bot. for 1871.* [No characters are given.] Mr. A. G. More is the only English botanist who has applied the name "*capitata*" to English specimens of *Erythræa*; but evidence is wanting to show how far Mr. More distinguished the *capitate* variety of *E. Centaurium* from the plant which is the principal subject of this paper; for both grow abundantly in the localities named by Mr. More.

Mr. James Lloyd has kindly sent me specimens of his "*E. Centaurium*, β . *E. capitata*, Rœm.," from the Loire Inférieure; and I have no hesitation in referring them to the *capitate* variety of *E. Centaurium*, and in considering them quite distinct from the Isle of Wight *Erythræa* with free filaments. Mr. Lloyd also sent me a specimen which had been given to him as *E. Centaurium*, β . *suffruticosa*, Griseb. (*Chironia suffruticosa*, Salz.). I believe, with Mr. Lloyd, that this specimen must be referred to his *E. capitata* from the Loire Inférieure, which, as I have just observed, is a *capitate* variety of *E. Centaurium*.

Since Willdenow's time botanists have been unsuccessful in

* Mr. More adds:—"This is, I believe, the plant given in 'Flora Vectensis' as *E. littoralis*, which I have not succeeded in finding in the Isle of Wight." The stations given by Dr. Bromfield in 'Fl. Vect.' are "Alum Bay, between Grove's Hotel and the sea; Headon Hill, within twenty yards of Mr. Ward's cottage; sea-banks near Compton." Dr. Snooke, in his 'Fl. Vectiana,' records '*Chironia littoralis*,' "Dwarf Tufted Centaury," from "sea-banks near Compton" (Snooke, 'Fl. Vect.' p. 12, 1823). Compton is east of and near Freshwater

refinding his *E. capitata*, though they have frequently sought for it; it appears, therefore, that it is extinct. With the exception of this and the Freshwater plant and two specimens of a similar one from the neighbourhood of Newhaven in Sussex, I know of no instance of an *Erythrœa* with similar characters. That these characters mark a distinct species I feel perfectly satisfied; and the description given in this paper will, I think, satisfy other botanists that I am correct in my conclusions. In accordance with the generally received rules of nomenclature, it would seem that the English plant must receive the specific name "*capitata*;" for I believe both it and the German plant agree sufficiently to constitute them two varieties of one and the same species. Which is the type? The Berlin plant has been only once found, and has not been refound for more than half a century, and is probably extinct. The English plant has been found in two distinct localities; and in one of these at least it exists in abundance at the present time: it is also probable that it has a still more extended range. Unfortunately the name "*capitata*" has been variously applied, and by existing botanists is now invariably given to a variety of another species. To give the simple name "*capitata*" to the Isle of Wight plant would therefore, in all probability, either consign it to oblivion, or to the liability of its being confounded with the variety of *E. Centaurium*. I have therefore given varietal names to both forms.

It remains now to give the specific character and description, and, finally, to point out how the species differs from its neighbours.

ERYTHRÆA CAPITATA, Willd.—Caule ($\frac{1}{2}$ –3 poll.) plerumque simplici et solitario erecto subangulato, foliis rosulatis ovatis ovato-oblongis obovatisve spathulatis obtusis 3–5-nervatis, foliis caulinis paucis connatis angustioribus, floribus subfasciculatis in capitulo dense congestis sessilibus numerosis cum bracteis obtusis intermixtis, bracteis exterioribus flores æquantibus vel superantibus, calyce corollæ tubo æquali, filamentis in imo tubi corollæ insertis, stylo obliquo, quadrante parte ovarii sub anthesi exserto, capsula calycem excedente. (1) vel (2)*.

In pascuis apricis.

Caulis sæpe in superiore parte ramum nudiusculum unum alterumve capitulo terminatum emittet.

* The only other notice I can find of any species of *Erythrœa* being biennial is that given by Brotero in a long description of his *Erythrœa chloodes*, where he says, "radice annua, aut non rare biennis" (*Broter. Fl. Lus. i. p. 277*).

Var. α . WILLDENOWIANA.—*E. capitata*, Willd. Bracteis acutis, laciniis calycis lanceolato-subulatis, laciniis corollæ elliptico-lanceolatis acutis. Latet locus natalis.

Var. β . SPHÆROCEPHALA.—Bracteis subobtusis, laciniis calycis lanceolatis, laciniis corollæ ovalibus obtusis. On the downs of Freshwater, Isle of Wight, and Newhaven, Sussex. July, Aug.

Description of English form (β).—Annual or biennial. Root fibrous, rigid, tapering, slightly branched, pale yellowish white. Stem usually simple and solitary, from $\frac{1}{2}$ to 3 in. in height, erect, subangular, the angles formed by the decurrent margins of the leaves, and from the central nerve on the underside of each leaf, glabrous. Root-leaves numerous, forming a rosette, sessile, horizontal, flat or canaliculate, often curved, ovate or ovate-oblong, more or less spatulate, obtuse, entire, with three principal nerves reaching the apex of the leaf and forming three elevated ridges on the underside, the central nerve often forming an apiculus, glabrous, or with a few long hairs when young, darkish green, paler beneath; the broader leaves five-nerved at the base, but the exterior nerves not reaching the apex of the leaf. Stem-leaves few and in pairs, subconnate, narrower and often longer than the others. Flowers numerous, sessile, in a subfasciculate compact terminal head, formed of many bracteated imperfect cymes, the branches of which are suppressed, and the cymose character almost lost. From the outer bracts long-stalked secondary heads of flowers, which exceed the primary heads, are frequently produced, giving the appearance of the plant being proliferous. Bracts numerous, the outer leaf-like, often wider at the base, two or more of them equalling in length the head of flowers; inner bracts gradually decreasing in size, linear; larger ones obtuse-apiculate, smaller ones acute. Calyx about equalling the corolla-tube, cylindrical, with minutely serrulate angles, five-lobed; lobes somewhat unequal, one-nerved, much longer than the tube, triangular-lanceolate, with narrow membranous borders, the border broadening below and sometimes minutely denticulate. Corolla-tube pale greenish yellow, hardly lengthening after flowering, equalling or shorter than the corolla-segments, which are oval, obtuse, concave, of a deep pink without, of a paler colour within. Under the microscope the pink colour on the back of the segments is seen to be produced by the pigment enclosed within very minute elongated cells. Stamens 5, shorter than the corolla-segments; filaments thread-like, flattish, attached only at

the base of the tube of the corolla, perfectly free above. Anthers yellow, oval, spirally twisted when empty. Ovary cylindrical, about $\frac{1}{2}$ of its upper portion exerted beyond the corolla-mouth at the time of flowering. Style oblique, short, thread-like, cylindrical. Stigma greenish yellow, expanding into two roundish flattish lobes. Capsule cylindrical (obtuse?), tipped with the style, imperfectly two-celled, about one third longer than the calyx, its lower two thirds invested with the enlarged marcescent corolla-tube. Seeds small, numerous, irregular in shape, subspheroid, angular, minutely reticulated, dark brown.—In England the plant grows among the short herbage of open chalk-downs and near the sea. It flowers in July and August, and is in fruit in September. It is abundant on the downs of Freshwater towards the east and west. There are two specimens in Mr. Joseph Woods's herbarium, from "near the signal-post at Newhaven, Sept. 9, 1836;" they are named *E. latifolia* by Mr. Woods. The only other instance of the probable occurrence of *E. capitata* var. *sphærocephala* as an English plant has been furnished me by [the late] Mr. R. A. Pryor, who wrote that, in the Oxford Herbarium, he had examined some specimens, in which both he and Prof. Lawson believed the stamens to be inserted at the base of the corolla-tube. These specimens were, I believe, from Somersetshire.

It may be presumed that the duration of the plant is both annual and biennial; that it is biennial is proved by the following facts. Last season Mr. F. Stratton, at my request, kindly collected seeds from Freshwater and sent them to Mr. H. C. Watson, who in September last informed me that he had sown them in pots, that they had germinated and formed young plants, but that they had not thrown up any flowering-stem. On hearing this it occurred to me that the plant might be biennial; and early in October last I paid a visit to Freshwater in the hopes of finding seedlings from nature's last year's sowing. I was soon rewarded by the sight of numerous healthy young plants *in situ*, a dozen of which I carefully took up and potted. I have sent three of these to Kew, and three to the Botanic gardens of Cambridge. There is every appearance of these young plants having germinated many months since; the roots are strong, the leaves are well developed in the form of rosettes, but there is no sign of any flowering-stem. I could find no young plants of *E. Centaurium* or *E. pulchella*, both which species grow abundantly in the same place where I gathered *E. capitata* var. *sphærocephala*. Without

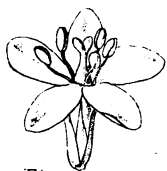

Fig. 5.

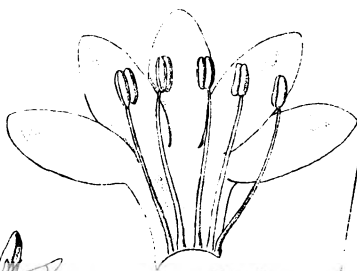

Fig. 6.

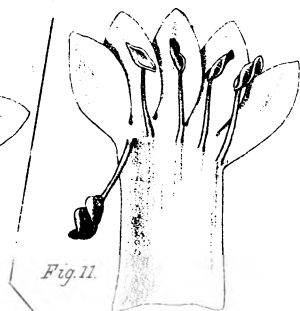

Fig. 11.



Fig. 7.

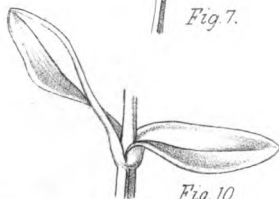

Fig. 10.



Fig. 9.



Fig. 1.

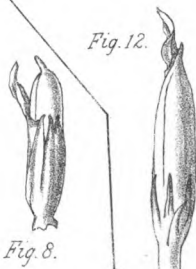

Fig. 8.

Fig. 12.



Fig. 3.



Fig. 4.



Fig. 2.

Blair lith.

Fitch imp.

1-10 ERYTHRAEA CAPITATA, Willd. var. SPHÆROCEPHALA, Towns.
11-12 E. CENTAURIUM, Pers.

further experiment, I would not assume that the latter is the only one of our native species of *Erythræa* which is biennial. Should it be ascertained that *E. capitata* var. *sphærocephala* does not stand alone in this peculiarity, there remain other characters by which it may be distinguished; should the proof lie the other way, and it be found that *E. capitata* var. *sphærocephala* is the only English biennial species, the character is a very marked one.

I would conclude this paper by pointing out that *E. capitata* var. *sphærocephala* may be distinguished from *E. Centarium*, var. *capitata* auct., by its narrower leaves, longer and subobtusely bracts, the outer ones equalling or exceeding the flower-heads, by its densely capitate, subfasciculate sessile flowers, its shorter corolla-tube, which does not exceed the calyx, by its filaments attached only at the base of the corolla-tube, by its shorter capsule, only three fourths of which are invested by the marcescent corolla-tube, &c.

From *E. littoralis*, Fr., *E. capitata* var. *sphærocephala* may be distinguished by its broader and distinctly 3-nerved leaves, by its more humble growth, by its short corolla-tube, its filaments attached at the base of the corolla-tube, by its oblique style, its capsule not covered by the marcescent corolla-tube, by its roundish compact heads of flowers, &c.

DESCRIPTION OF PLATE XV.

Figs. 1 and 2. *Erythræa capitata*, Willd., var. *sphærocephala*, nob.

3. Another plant of the same in fruit, with one central and two lateral main stems.

4 and 5. The flower, magnified.

6. Corolla of the same, laid open to show the insertion of the filaments.

7. A small secondary flower-head in fruit.

8. Capsule of *E. capitata*, var. *sphærocephala*, magnified, four lobes of the marcescent corolla having been removed, and one left, to show the capsule exceeds the corolla-tube.

9 and 10. The stem-leaves, slightly enlarged in fig. 10.

11. *Erythræa Centarium*: the corolla laid open, to show the insertion of the filaments; one of these has been bent down. Enlarged.

12. A capsule of *E. Centarium*: one lobe of the marcescent corolla left in position (the four other lobes having been removed), to show that the capsule and the corolla-tube are about equal.

The Theory of the Growth of Cuttings; illustrated by Observations on the Bramble, *Rubus fruticosus*. By FRANCIS DARWIN, F.L.S.

[Read December 16, 1880.]

Theory of the Growth of Cuttings.

WHEN a cutting (for instance, a piece taken from the branch of a Willow) is placed in damp air, it produces roots at the lower end, while the buds at the upper end grow out into branches. The question as to what are the causes which determine the roots and branches to grow at these places has lately attracted a good deal of attention among physiologists. The works which are of especial importance on the subject are Vöchting's 'Organbildung im Pflanzenreich' * and Sachs's paper "Stoff und Form der Pflanzenorgane" †. Sachs's essay is in some measure a critique on Vöchting's work, and the latter author has replied in a paper in the 'Botanische Zeitung' (1880, p. 593).

Vöchting divides cuttings into two chief classes. First, there may be cuttings which consist of a simple piece of stem or branch, without buds (which may be either absent or destroyed), and without those beginnings or rudiments of roots which are called in German "Anlagen." When such a cutting develops buds, they must of course be adventitious ones; therefore both the branches and the roots produced by the cutting must be new growths, formed after the cutting has been separated from the mother plant. In these cuttings the roots tend to be developed at the basal ‡ end (in ordinary cases that which was the lower end when the twig was attached to the plant), while the branches grow at the opposite or apical end. And these growths take place, in large measure, independently of the external forces, light and gravitation. Thus (to confine the discussion to the effects of gravitation) the growth is of approximately the same character whether the cutting is placed with its basal end upwards or downwards. When a branch is divided into a number of cuttings, each of which produces roots at its basal and branches at its apical

* Bonn, 1878.

† Arbeiten des bot. Inst. in Würzburg, 1880, p. 452.

‡ "Basal" means the end of a stem or branch which is nearest the root of the parent plant. "Apical" means the opposite end.

end, every one of the cuttings is capable of developing into a new individual: such an individualized portion of a branch is called by Vöchting a *Lebenseinheit* or "*Life-unit*." At the point where the knife divides the branch it separates a mass of similar cells into two sets, viz. cells which form part of the base of the upper life-unit, and which therefore form roots, and others which belong to the apex of the lower unit, and which develop into buds. The conclusion which Vöchting arrives at as to this simple form of growth is thus given*:—"A living vegetative cell which is capable of growth has not a specific and unalterable function." "The function assumed by a cell depends on the morphological position which it occupies in the life-unit, as the most important condition."

The second class of cuttings are those which already possess "Anlagen" of two kinds—that is, buds and rudimentary roots. Here the same relations hold good. The buds near the apex of the life-unit develop rather than any others, and the root-rudiments near the base develop rather than those near the apex; and this takes place in great measure independently of the position with regard to gravitation occupied by the life-unit.

Vöchting gives this law †:—"When there are a number of rudiments of equal strength and morphological rank, the energy of development of the individual rudiments will depend (as the chief condition) on their morphological position in the life-unit."

From a very large number of experiments, including both classes of cuttings, Vöchting concludes that there is an innate hereditary tendency ‡ in plants which leads to the production of roots at the basal and branches at the apical end of the life-unit. Besides this innate tendency, the external forces, gravitation and light, have an influence on the development of organs. Vöchting § gives two laws formulating his conclusions as to the action of the external forces, the chief point being that the external forces are of secondary importance in comparison to the innate growth-tendency. In summing up this part of the question,

* 'Organbildung,' p. 241.

† *Loc. cit.* p. 241. His second law about rudiments of unequal strength I have omitted.

‡ Vöchting's term "*morphological force*" seems to me a useful one to express the innate tendency to the production of organs in *morphologically* determined positions.

§ *Ibid.* p. 243.

Vöchting concludes that a vegetative cell, or group of cells, has such a physical constitution that it requires a certain disturbing force (Anstoss) to make it develop into the rudiment of a root or bud. Disturbing forces or stimuli arise in the life-unit itself and influence the course of cell-division; but such stimuli may also come from external forces.

This, though not any thing like a full account of Vöchting's results, may serve as an introduction to my own work. With the same object, Sachs's conclusions will be briefly summarized. The fundamental point of difference between Sachs's and Vöchting's theories is, that Sachs does not believe in a hereditary growth-tendency. Instead of placing gravitation and light in the second rank of causes, Sachs believes that the growth of organs in the life-unit is entirely regulated by these external forces. According to his views*, the force of gravity, acting on the developing cells of an organ, build up in it a predisposition to the production of roots and buds at the base and apex. This after-effect of gravitation he believes to produce the effects ascribed by Vöchting to a hereditary morphological force.

Sachs differs entirely from Vöchting in the view he takes of the mode of action of the external forces. We have seen that Vöchting considers gravity as an "Anstoss" or stimulus, which tends to produce certain kinds of growth because of the physical constitution (*materielle Aufbau*) of the formative cells. Sachs's theory rests on the belief that difference of material is a necessary concomitant of difference of form. According to this view, we must believe that the materials from which roots are formed are chemically (in a qualified sense, *loc. cit.* p. 456) different from those which supply branches. Sachs's theory supposes that the growth of roots or buds at a given place will be determined by the distribution of the root- and branch-forming materials; and, further, that the distribution of these materials is regulated by the force of gravity. The root-material is, in a certain sense, geotropic, and flows downwards; the branch-material is apogeotropic (negatively geotropic) and flows upwards. The impulses which cause the formative materials to flow in these directions are supposed to continue as an after-effect of the force of gravity; so that the production of roots at the basal end of a cutting hung upside down is an after-effect of the original tendency of the root-material to flow downwards.

* *Loc. cit.* p. 474.

With this part of Sachs's theory I am not specially concerned; my chief object was to determine whether the phenomena of growth in a cutting are the expression of a morphological force, or are produced by the after-effect of gravitation.

Observations and Experiments on the Bramble.

For reasons that will appear later on, I wished to study the behaviour of cuttings in relation to the natural mode of growth of their parent plants: with this object I chose the Bramble for observation, because of its habit of forming roots at the end of its branches. This curious habit does not seem to have attracted much attention from botanists. It is briefly described by Duhamel*, also by Nees and Weihe†, who refer to a mention of it in Pliny.

Lees‡ mentions the rooting of the branches in his paper, "On the Mode of Growth of the British Fruticose Brambles." The chief point of interest is, that the branches are by no means always biennial; the barren rooting-branches may produce barren side-shoots, which flower in the third year and then die; or the barren shoot, after flowering in the second year, may send out barren shoots in the third year, which do not flower until the fourth year§; and, under certain circumstances, life may be prolonged for at least five or six years.

Bell Salter's "Observations on the Genus *Rubus*"|| contain some remarks on the habits of growth of Brambles. He describes the ordinary habit of *R. discolor* (Weihe & Nees), "the commonest of our English brambles," and agrees in the main with Lees as to the way in which the growth continues for several years.

Vaucher¶ mentions this mode of reproduction as common to *Rubus fruticosus*, *cæsius*, *villosus*, *laciniatus*, *hispidus*, and, generally speaking, to the biennial class of *Rubus* with palmate leaves.

More recently, Germain de St. Pierre** has called attention to the rooting of the Bramble, and gives a general description of the process.

The essential facts are, briefly, that the end of the shoot makes

* 'Traité des Arbres,' tom. ii. p. 233 (1755).

† *Rubi Germanici*, 1822-27, Introd. p. 4.

‡ Proc. Bot. Society Edinburgh, March 9th, 1843, vol. i. p. 171.

§ He describes six modes of branching.

|| The 'Phytologist,' vol. ii. p. 91 (1845).

¶ 'Histoire Physiologique des Plantes d'Europe,' 1841, t. ii. p. 272.

** Bull. Soc. Bot. de France, t. xxii. 1875, Seance Extr. d'Angers, pl. liii.

its way into the soil, where it puts out numerous strong roots, which fix it firmly in its place. The roots may arise within a few millimetres from the apex, and extend for some two or three centimetres. If a well-rooted bramble-shoot be pulled up, the growing end of the shoot may be seen surrounded by a nest of radiating roots; this growing end rests during the winter months, and shoots up into a new branch in the spring (Vaucher and Germain de St. Pierre). The end of the shoot is much thickened, and is covered with scale-like rudimentary leaves, and with small prickles densely crowded together; it forms, as Germain de St. Pierre calls it, a "*tubercle bulbiforme*," supplying a store of nutriment for the new growth in the following spring. Branches which have not yet produced roots, but which have grown in shady places, such as among tufts of coarse grass, present a peculiar appearance, which precedes the production of roots: the shoot does not taper, but is cylindrical, or even thicker at the apex than further back; it is generally pale in colour from being semietiolated, and its leaves are dwarfed or scale-like. Germain de St. Pierre notices this fact.

The natural growth of roots in the Bramble differs strikingly from their growth in an ordinary life-unit or cutting; for in all ordinary cases the roots grow at the basal end, whereas in the Bramble they are developed at the apex of the branch. It may be objected that since the growing end of the Bramble develops into a new growth in the spring, the autumnal roots are potentially at the base of a future branch, and not at the apex of the present one. If we look at the facts by the light of Sachs's theory, that the materials for the formation of roots and branches are endowed with specific powers of flowing in different directions, we shall be obliged to consider the growth at the apex of the bramble-branch as true apical growth; since the flow of formative material can have nothing to do with the future continuation of the branch, but must have taken place in the existing part of the branch, and therefore towards the existing apex. It is sufficient for my purpose to be able to say that the roots appear at what is, for the time being, the apex of the shoot.

It is the long trailing branches of the Bramble which usually reach the soil and take root; and since these branches must necessarily have been directed downwards during the latter part of their period of growth, it naturally occurs to one as probable that the roots may be developed at the apex of the branch in obedience to gravitation. For if gravitation and its after-effect determine

the distribution of roots, then their growth at the lower end of a bramble-branch would correspond with their growth at the lower end of a cutting. But further observation of the habits of the Bramble make it almost certain that this cannot be the case. Where a Bramble grows on a steep bank, a large number of the branches grow simply down the slope, a further number grow more or less horizontally along the bank and ultimately grow down hill. But a few branches will be found which grow up the slope, and some of these form roots. I have observed this fact among the Brambles clothing a steep bank, cut in the chalk, many parts of which are inclined at 55° to 65° .

The following are the details of some observed cases. The measurements are taken from the root of the plant to which the branch belongs. At the apical end of the branch the measurements are taken to the surface of the soil where the branch enters it, which is almost equivalent to the spot where the roots are produced.

1. A branch grew well above the horizon for several feet, then 6 inches at 10° above the horizon, ending with a single inch 2° or 3° below the horizon, and then produced roots.

2. Grew for 2 feet 10 inches nearly vertically upwards (including the parent branch, from which the branch which ultimately took root sprung), then 8 inches at 15° below the horizon, and produced roots.

3. Grew upwards and highly inclined for 2 feet 3 inches, then 8-9 inches at 5° below the horizon, and produced roots.

4. The first 4 feet were at 10° above the horizon, then came 1 foot 2 inches, which formed a curve (concave towards the bank) whose chord was at 55° . The terminal 2 inches were at 5° below the horizon; and the extremity had taken root.

5. The first 1 foot 6 inches were at 60° above the horizon, then came 2 feet 3 inches horizontal, then 2 feet 8 inches 30° above, and at last 2 or 3 inches at 5° below the horizon, then the roots at the end.

It seems hardly possible that the terminal portion (from 1 to 9 inches in length), being a few degrees below the horizon, can determine the production of roots at the apex. We must, I think, conclude that when the apex of a branch can, as in these cases, reach the soil without hanging downwards, it is able to produce roots at the apex. This is quite inconsistent with the belief that the distribution of root-development is determined

by gravitation ; since the relation between the chief direction of growth and the force of gravity is exactly reversed in the above cases when compared with the rooting of pendent bramble-branches. It seems only explicable according to Vöchting's law, that there is a tendency to the production of organs in certain morphological positions, a tendency in large measure independent of external forces. This conclusion is supported by the results of the following experiments :—

Two Brambles, which were growing horizontally, or slightly above the horizon, were (Sept. 14 and 23) tied apex upwards to vertical sticks. They were at first wrapped up in yew-branches ; but as this did not seem to give the necessary amount of dampness nor to exclude enough light, they were subsequently covered up with damp moss, which was wrapped round with waterproof cloth. At one time both of them bent over so as to become nearly horizontal, and were then tied up again so as to remain vertical. They remained in this position until Nov. 16. It was then feared that the cold weather would prevent the development of the rudimentary roots, which could just be distinguished, and they were accordingly freed from their connexion with the parent plant, the apex remaining uninjured. They were placed in damp air and kept dark, the cut ends being immersed in water. Under these conditions, in an ordinary room, a root, about a centimetre in length, was (Nov. 22) developed at the apex of one of them ; and by Nov. 26 the terminal 4 cm. was studded over with roots breaking through the epidermis. The growth at the apex of the branch seemed to be checked, and several minute root-bearing shoots were developed in the axils of the terminal leaves.

In concluding that there is a morphological force in the Bramble which leads to the production of roots at the apical end of the branches, I am far from denying that gravitation has an effect on their production. At the same time that the above-described experiment was made, two other Brambles were tied (Sept. 14) apex *downwards* to vertical sticks, and were covered with moss and yew-branches. On Oct. 14th one of them had produced a number of strong roots at its apex, the other one had grown out below the mass of moss &c. and had not rooted. This fact makes me suspect that gravitation is an accessory stimulus for the production of roots at the apex. This question I hope to decide next autumn.

*Observations on Cuttings and Mutilated Branches of the
Bramble.*

The secondary branches which develop when the end of the primary branch is injured are of two types, which, however, graduate into one another. The first kind is the ordinary leaf-bearing branch, which does not differ from the primary or parent branch. The second type may be called a root-bearing branch*. I found two examples of this kind springing from the apical buds of a branch which hung down into a mass of thick vegetation. The end of the primary branch had become etiolated and thickened, but had been in some way injured before it could produce its roots. The result was that the two most apical buds had grown into semi-etiolated, root-producing branches. These are distinguished by being short (12 and 7 millims.), thick (3 or 4 mm.), and club-shaped, *i. e.* thicker at the apex than the base, by having scale-like leaves, and by producing a crown of rudimentary roots at their club-like ends. In fact they differ from an ordinary side-branch exactly as the root-bearing extremity of the primary branch differs from a common leaf-bearing branch. This type of root-bearing branches I have frequently produced artificially; but the above is the only instance occurring in a state of nature which I have met with.

Figs. 1 & 2 (p. 414) will give an idea of the general appearance of these curious objects. Fig. 2 is drawn from the above-mentioned branch tied vertically up in damp moss, and which produced a few side-shoots.

In the other cases which I have observed of primary branches injured in a state of nature, the root-bearing secondary branches were not of the pure root-bearing type, but rather leaf-bearing branches, which ultimately became root-bearers. Thus I found a primary branch which seemed to have been injured by being trodden on, and the most apical bud had grown into a thin cylindrical branch 9 centims. long, which had then developed roots. Another injured Bramble had produced, from near its apex, a side-shoot 17½ centims. in length, which in like manner bore roots at its extremity.

* It is probably to this type that Bell Salter refers (*ibid.*) when he says:—
“The part nearest the end bears no buds, as a general rule, capable of producing shoots, but only of rooting; for I know, from very recent observation, that not only the extreme point, but also the buds near it, are capable of rooting, and occasionally do so.”

Fig. 1.

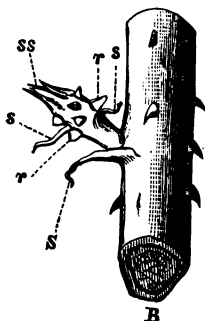

Fig. 2.

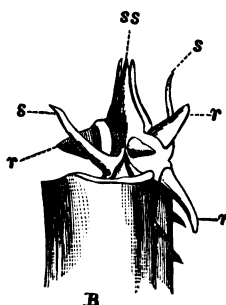

Fig. 1. Root-bearing shoot produced by a bramble-cutting made from a depending branch, but placed apex upwards in the jar. B, the cutting; S, one of its scale-like leaves, in the axil of which the side-shoot is produced; *ss*, the tuft of scale-like leaves at the end of the side-shoot; *s*, the similar scales from among which the roots, *r*, are produced.

Fig. 2. Root-bearing side-shoot, produced from the Bramble tied vertically up in damp moss (see p. 412). The main branch has been cut off on the apical side of the shoot, and the leaf from whose axil it grows has been removed. Lettering as in fig. 1.

Or such cases as the following occur. A bramble-branch, being injured, produced branches from the three most apical buds. Of these one was 123 centims. long, and had developed roots at its apex; then the apex seems to have become unhealthy, for, 7 centims. from the end, it had produced a tertiary branch 16 centims. long, which also developed roots at its apex. It is probable that in the first-described case the damp and dark situation into which the end of the primary branch had grown caused the side-shoots to assume at once a root-producing character, while in the other cases the side-branches (like the main branch) do not produce roots until they have found a suitable situation.

It is this tendency to produce root-bearing shoots which makes it possible to study the growth of roots in the Bramble by means of cuttings.

The experiments with cuttings were made according to Vöchting's method. Pieces of Bramble, generally about 40 centims. in length, were hung vertically inside tall glass jars. The air was kept damp by a lining of filter-paper, which was constantly mois-

tened by a few centimetres of water at the bottom of the jar. The vessels containing the cuttings were then placed in the dark, either in an ordinary room or a cool greenhouse.

Unfortunately but few experiments were made before the frosts killed the buds on all the Brambles in the neighbourhood, so that further work was impossible.

Exp. I.—Sept. 6th. Four cuttings were made, each being 40 centims. in length, and consisting of well-formed wood, the turgescent parts near the apex of the branches being removed.

1. Grew nearly vertically upwards. Placed apex downwards in the jar. The most apical bud grew out with a branch, but no roots were developed.

2. Grew about 10° above the horizon. Placed apex upwards. The most apical bud did not develop, but the next one grew out into a thick shoot, 15 millims. in length, which, on Oct. 11th, bore two small roots, growing out at 5 to 6 millims. from the apex and from the lower side of the shoot.

3. Grew originally 10° – 20° below the horizon. Hung apex downwards. On Sept. 23 the three most apical buds had developed into shoots, which curled up apogeotropically. The apical shoot was the best developed, being 14 millims. long and 5.5 thick at its base. All three had produced roots 2 to 5 millims. long, growing chiefly from the lower side of the new shoot. The root-production was more vigorous than in 2.

4. Thin shoot growing 20° – 30° below the horizon. Hung apex upwards. On Sept. 21 its apical bud had produced a shoot 15 millims. in length, which, however, never produced roots.

The production of roots from the side-shoot (2) is not conclusive that the root-growth tends to take place at the apical end of the cutting when the apex is upwards; for, since the most apical bud did not develop, there was a piece of stem above the developing 2nd bud, so that a believer in the action of gravity might say that the formative materials flowed down from this piece of stem to the bud.

Exp. II.—The next experiment was made entirely with such parts of branches as had grown inclined above the horizon, and they were all at first hung the apex upwards. They were all about 40 centims. long; and after a soaking in water for 16 hours (apex upwards) they were placed in the jars on Sept. 23.

1. On Oct. 4th the apical bud had grown best, although badly, but had produced no roots. It was now hung in the inverse position; and on Nov. 3rd (possibly some days earlier) the apical shoot had produced a few small roots.

2. The most apical bud, 3 centims. from the end of the cutting, was the only one which was developed; and on Nov. 9th it had grown into a shoot 4 centims. long, 3 millims. thick at the base, and tapering towards the tip. At 9 millims. from the apex of this shoot was a shining projection, which was proved by microscopical examination to be the rudiment of a root. I had observed this swelling several days previously; but as it had shown no signs of increasing in size I thought it useless to continue the experiment.

3. The most apical bud did not develop; the next three buds, distant 15, 28, and 34·5 centims. from the apex, were well developed on Oct. 24. The most apical shoot was 25 millims. in length to the tip of its scale-like leaves, 7 millims. thick, and had two or three roots growing out from its lower side, and many others just visible as rudiments. The other two shoots showed no sign of root-formation. This case is irreconcilable with the belief that the root-forming matter in the cutting tends to flow downwards; for if this were the case, the lower, not the uppermost, shoot would have produced roots. We may therefore attach more value to the case of bramble No. 2 in the first experiment (see p. 415).

4. The apical bud, 25 millims. from the end, was the only one which developed; and on Nov. 9th it had grown into a shoot 5 centims. long, 5 millims. thick at its base, and tapering towards the tip. At 8 and 13 millims. from the tip were two shining swellings, about 1 millim. in height, which were proved microscopically to be undeveloped roots.

5 & 6. The most apical bud developed in both, but decayed without rooting.

7. Oct. 4th, the apical bud was developed, but had not rooted. It was then hung in the inverse position; and on Oct. 20th it had made a few small roots.

As already pointed out, the cases such as No. 2 in Experiment I. and No. 3 in Experiment II. are not quite conclusive; but Nos. 2 and 4 in the second experiment leave no room for doubt. The part of the branch from which the root-bearing side-shoot was developed had always grown above the horizon; it had hung apex upwards during its life as a cutting; the shoot was developed from the most apical bud, close to the end of the cutting; and the rudiments of roots were developed near the apices of these side-shoots*.

* Some other experiments were made on cuttings and mutilated branches

Before finally giving the conclusions for which these facts give part of the data, it will be well to state clearly what is meant by the after-effect of gravitation, which is not a well-defined term. Thus, for instance, Vöchting* believes that his innate growth-force has arisen as a "gradually accumulated function" of gravitation and light. Such an effect might, no doubt, be called an after-effect; but it is not in this sense that I use the word: I take it to mean the growth-tendencies which are produced in an organ through the action of gravitation *during the development of the constituent cells of the organ in question*. It is in this sense that Sachs† alludes to the effect produced by the previous action of gravitation; for he speaks of an organ kept in slow rotation during its growth as being thus freed from the predisposing influence of gravitation.

Since, then, we have seen that Brambles, whether they have grown above or below the horizon, tend to produce both leaf-bearing and root-bearing branches near the apex, we cannot account for the fact through the after-effect of gravitation, but must believe in some internal morphological force.

Thus the result of the experiments confirms the conclusions arrived at with regard to the normal growth of roots at the end of branches (see p. 412).

Vöchting has made the interesting observation (Bot. Zeitung, 1880, p. 595) that cuttings made from branches of weeping varieties of various trees behave like cuttings of ordinary trees, and produce roots at their base and branches at their apex. This fact shows that the distribution of root-growth and branch-growth is exactly the reverse of that in ordinary cuttings, *when considered in relation to gravitation*; but it does not, I think, prove the existence of a morphological force. It might be assumed, by a modification of Sachs's hypothesis, that the sensitiveness to gravitation has been reversed in the branches of weeping trees, and that the tendency to produce shoots at the apex is a consequence of this kind of sensitiveness. The cutting of a weeping tree would thus differ from an ordinary cutting just as an apogeotropic organ differs from a geotropic organ, in having a reversed sensitiveness to gravitation. But such an objection cannot be urged against the

which had grown apex downwards in a dependent position, with the result that the most apical buds grew into side-shoots, which assumed in some cases a root-bearing character.

* Bot. Zeitung, 1880, p. 596: "Eine allmählich accumulirte Function der genannten beiden Kräfte."

† *Loc. cit.* p. 475.

conclusions with regard to the growth of Brambles; for a Bramble, which may be said to produce weeping and erect branches on a single plant, could not, by any kind of sensitiveness to gravitation, always produce its roots at the apex of the branches.

The second object which I had in view in working at the Bramble was to answer the questions, Why is it that a plant is divisible into cuttings having certain growth-tendencies? How can it help the plant in its normal growth, to possess the properties which exist in the artificially produced life-unit? I have been able to form a hypothesis with regard to the Bramble which may prove to be applicable to other plants. When any injury happens to the apical end of a bramble-branch (the basal end being in continuity with the parent plant), one or more buds grow out into side-branches. These side-branches may either be ordinary leaf-bearing or else root-bearing branches. In either case they perform the function which the injured part of the parent branch would have performed. And this power of carrying on the *function* of a part, in spite of an injury received, must clearly be advantageous to the plant*. The question then arises, Which bud is in the best position to carry on the disturbed function? And it seems quite clear that the buds morphologically nearest to the apex must be in the best position for carrying on the function of the apex. If, for instance, a branch growing down towards the earth is injured, and thus prevented from bearing roots at its natural apex, the most apical bud will be in the best position for producing a rooting branch at least cost of growth. Again, the distribution of the Bramble is facilitated by the power which the branches have of creeping along the ground, and taking root many feet (*e. g.*, 8 feet) distant from the parent plant. If such a branch is injured, the most apical bud will be in the best position for continuing the duty of providing for the distribution of the plant, and thus carrying out this function of the injured apex.

* Vöchting says ('Organbildung,' p. 107) that "If the actually or potentially unlimited growth of the stem or root is interrupted by section, it (the growth) is continued at the ends thus formed, either by rudiments (Anlagen) already present there or by new formations. The roots at the apical end of a root, and at the apical end of a branch, represent the continuation of the interrupted apical growth of the root; the buds at the apical end of a branch, or at the basal end of a root-cutting, represent the continuation of the interrupted apical growth of the branch." (The phrase which I have translated "represent the continuation" &c. is "stellen die Folge der Unterbrechung des Spitzenwachsthums . . . dar.")

The same kind of argument might, I believe, be applied when any other function of a branch is interrupted through injury.

If this conclusion as to the growth of the most apical bud on mutilated branches of the Bramble be correct, it may, I believe, be directly applied to explain the growth of bramble-cuttings.

In a bramble-cutting the only growth which takes place, whether of roots or branches, tends to occur at the apical end. Such a cutting resembles, in fact, one of the above-mentioned mutilated branches, except in that it has been separated at its base from the parent plant. And the morphological force which resides in the cutting is the same thing as the regenerative impulse which makes the more apical buds take up and continue the function of a branch whose apical part has been injured.

A Revision of the Genus *Vibrissea*. By WILLIAM PHILLIPS, F.L.S.

[Abstract. Read January 20, 1881.]

IN this communication the author in his introduction reviews the genus as established by the late E. Fries of Sweden; and he refers to the various species added by subsequent writers. He notices the curious characteristic phenomenon of their projecting their long slender sporidia with great force, and their giving a velvety appearance to the hymenium when removed from the water in which they grow. Crouan's *Vibrissea Guernisaci* differs in form from the genus as originally defined by the absence of a stipes; and hence some authorities have inclined generically to separate it; but Mr. Phillips finds it projects its sporidia, and for this and other reasons retains it and three other species in a sessile division of the genus. He selects *V. truncorum* as a typical form, and describes in detail its minute structure and other peculiarities. Thereafter he amends the definition of the genus as follows:—

VIBRISSEA, *Fries, amend.*—Aquatic fungi (except *V. rimarum*) bearing the exposed hymenium on a plane or cup-shaped membranous receptacle, stipitate or sessile, fleshy in texture, firm, ejecting from the asci slender elongated sporidia, which often remain attached by their extremities to the surface of the hymenium, giving it a velvety appearance. *Hab.* On decayed wood, submerged in water.

Descriptions of eight stipitate and four sessile species follow; and *V. Persooni*, Corda, and *V. pubescens*, Rabh., are rejected. The paper in full, with plates, will appear in the Society's 'Transactions.'

On the Power possessed by Leaves of placing themselves at Right Angles to the Direction of Incident Light. By FRANCIS DARWIN, F.L.S.

[Read December 16, 1880.]

It is well known that certain organs of plants have the power of growing in oblique or horizontal directions. The rhizomes of many plants extend horizontally under ground, thus growing at right angles to the direction of gravitation instead of parallel to it, like ordinary geotropic or apogeotropic* stems and roots. When the obliquely-growing organ is above ground the case becomes more complex; for here it is not only growing obliquely with respect to the gravitation, but also with respect to the chief portion of incident light, namely that which comes from the zenith.

A seedling radish growing in open ground may illustrate the case. The hypocotyl grows vertically upwards, being both apogeotropic and heliotropic, and therefore growing parallel to the incident light which falls on it from above, and also to the line of gravitation. But the cotyledons place themselves in a nearly accurately horizontal position, at right angles both to the line of gravitation and to the light. It will be found, however, that it is the direction of the light, and not that of gravitation, which determines the position of the cotyledons; for if the seedling be placed (with due precautions) before an oblique lateral light its cotyledons adjust themselves so that their surfaces are once more at right angles to the direction of the light.

The following investigation is an attempt to arrive at a clearer conception of the nature of the power which leaves possess of thus placing themselves at right angles to the direction of incident light.

It will first be necessary to give, as an introduction to my own work, a short account of the state of knowledge on the subject.

The two chief theories which I shall have to consider are those of A. B. Frank and of De Vries. Frank† supposes that,

* Geotropic is used to mean *positively* geotropic, apogeotropic to mean *negatively* geotropic, in accordance with the terminology used in 'The Power of Movement in Plants,' by C. Darwin, assisted by F. Darwin, 1880, p. 5.

† 'Die natürliche wagerechte Richtung von Pflanzentheilen.' Leipzig, 1870.

besides the ordinary and well known forms of growth, geotropism and heliotropism, through which organs place themselves in the line of the earth's radius, or parallel to the incident light, as the case may be, there are special forms of growth, called transverse geotropism and transverse heliotropism. An organ which grows transverse-geotropically places itself horizontally; it has an inherent tendency to be horizontal, in the same way that the hypocotyl of a seedling has an inherent tendency to grow vertically upwards. In the same way a transversely heliotropic organ has an inherent tendency to place itself at right angles to, instead of parallel to, the direction of incident light. It may be said that this is no explanation at all; and this is true in a certain sense. But there is no reason why it should be more unsatisfactory than the accepted explanation of the vertical growth of stems and roots, namely that they have an inherent power of growing in these directions*. Another explanation of the facts is that given by De Vries, in his paper "On the Direction of Bilaterally Symmetrical Organs"†. The work in question is in great measure a criticism on Frank's views, and proposes a theory of an entirely opposite character. De Vries believes it to be quite unnecessary to assume the existence of special forms of growth as Frank has done, and that the old forms of growth, positive and negative geo- and heliotropism, can, under certain conditions, account for oblique or horizontal growth. He thinks that Frank has neglected a possible explanation of the phenomena in the combinations and antagonisms which occur among the ordinary heliotropic and geotropic forces. Thus an organ might be apheliotropic‡ and apogeotropic, and when exposed to a zenith-illumination might remain horizontal in consequence of the balance between the apheliotropic tendency to grow away from the zenith, and the equal and opposite apogeotropic tendency to grow towards it.

De Vries's work also shows the existence of two forms of growth, independent of gravitation and light, which, he believes,

* The essential part of Frank's doctrine is accepted by my father in 'The Power of Movement in Plants,' p. 438.

† 'Ueber einige Ursachen der Richtung bilateralsymmetrischer Pflanzentheile,' Arbeiten des bot. Instituts in Würzburg, Heft ii., 1872.

‡ Apheliotropism is a convenient term, used instead of negative heliotropism. When used without the prefix apo-, positive heliotropism is meant. See 'The Power of Movement in Plants,' *loc. cit.*

play an important part in the formation of the balance between opposite tendencies just alluded to. These forms of growth are *epinasty* and *hyponasty*. An organ is said to be epinastic, in De Vries's sense, when the longitudinal growth of the upper half exceeds the growth in length of the lower half; epinasty, if unopposed, will therefore result in the organ becoming convex above and curving downwards. Hyponasty is the reverse of epinasty; that is to say, the organ curves upwards, owing to the lower increasing more than the upper half in length.

Frank subsequently replied to De Vries's criticism, and was again answered by De Vries. I shall not attempt to give any abstract of this discussion, though some points in it will be touched on later.

I have purposely given De Vries's theory in the simplest and crudest form, because this suffices to show the contrast between it and Frank's views; and this kind of exposition is enough to give an idea of the point from which I began my work. De Vries is careful to state that his views are only put forward as possible solutions of the problems. He points out the coexistence of a number of opposing growth-tendencies, and suggests how they *might* produce equilibrium. He does not intend his views to be applied to any special cases. He points out that a quantitative estimate of the opposing tendencies would be necessary before any special explanations could be possible.

The same principle which De Vries has formulated finds a prominent place in Sachs's paper, "Ueber orthotrope und plagiotrope Pflanzentheile"*. Thus, in explaining the power which *Marchantia* has of placing its thallus-lobes at right angles to incident light, he says (p. 239) that the plagiotropism (here equivalent to obliquity) of *Marchantia* may be regarded as a position resulting from negative geotropism, heliotropism (on the underside), and epinasty on the upper or light side. In the same way (p. 276), speaking more generally, he describes an organ as plagiotropic when it is negatively heliotropic, and at the same time negatively geotropic. The negative heliotropism seeks to bend it downwards, the negative geotropism upwards; thus, according to the specific sensitiveness to gravitation and light, and according to the intensity and direction of the latter, the organ will take up an oblique or horizontal position of equi-

* 'Arbeiten des bot. Instituts in Würzburg,' Bd. ii. Hft. ii., 1879.

brium. These extracts show that Sachs is, on the whole, in favour of an explanation in accordance with De Vries's views and opposed to that of Frank. There is, however, a feature in Sachs's views which does not occur in De Vries's; and this is the importance which Sachs attaches to the existence of specific sensitiveness to gravitation and light.

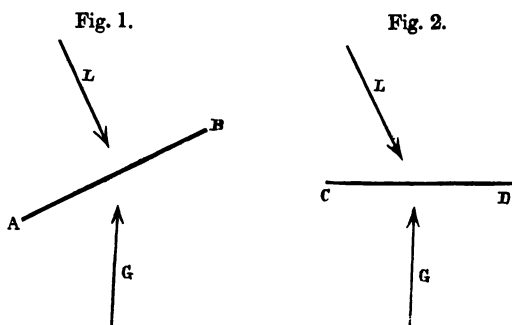

Diagrams illustrating different degrees of sensitiveness to light and gravitation.

If AB in fig. 1 represents an organ which places itself so that it is at right angles to the incident light, and if G represents the vertical direction in which gravity acts*, the specific sensitiveness to light is such that it requires the light to act with its greatest force, *i. e.* at right angles, in order to produce apheliotropic tendency strong enough to resist and balance the apogeotropic tendency; and the specific sensitiveness to gravitation is such that even when the organ is oblique, and when, therefore, the stimulus of gravitation must be feeble, the amount of apogeotropic action called into play is enough to balance the apheliotropism produced by the light.

The organ CD, shown in fig. 2, assumes a horizontal instead of an oblique position, because its specific sensitiveness to light and gravitation are different to those of AB: it is more sensitive to light and less so to gravitation; so that an amount of apheliotropism sufficient to balance the apogeotropism is produced by the weakened stimulus of oblique rays of light, and the necessary amount of apogeotropism is not produced until the organ is in

* The barbs of the arrows are made to represent the directions in which light and gravitation tend to cause the organ to bend; the stems of the arrows give the angles at which light and gravitation act.

the most favourable position for the action of gravity, *i. e.* horizontal.

I have dwelt on this view of specific sensitiveness, not only in order to give a clearer notion of Sachs's views, but because it leads on, as he himself states (p. 282), to the belief that light and gravitation act merely as stimuli ("Reize") on the organs of plants, the nature of the resulting behaviour of the plant being determined by the inner nature of the organ—as, for example, the uniform stimulus of gravitation is translated by a stem into a command to grow upwards, by a root into a command to grow downwards. And this theory of gravitation and light acting as stimuli is so necessary to the views which I hold on the subject, that I am glad to be able to give it the support of Sachs's opinion.

The Object of the present Research is, by observation of such organs as place themselves at right angles to the direction of the incident light, to determine whether the "Transversal-Heliotropismus" theory of Frank, or the balancement theories of De Vries and Sachs, is most in accordance with the facts.

It should be clearly understood that, in speaking of Frank's theory, I do not include his ideas about polarity, by means of which he seeks to explain transverse heliotropism and geotropism. I refer merely to the belief that a special form of heliotropism exists, in accordance with which an organ places itself at right angles to the light instead of parallel to it; and this I take to be the essential and important part of Frank's views.

Plan of Research.—The method which I have employed is essentially the same as that which has been employed in Sachs's laboratory for the study of ordinary heliotropism. The apparatus used for this purpose by Müller of Thurgau ('Flora,' 1876) consisted of a cylinder rotating slowly about its longitudinal axis, on which the seedlings under observation were grown. The cylinder was placed at a window; and the plants were protected from all illumination except such as fell on them in a direction parallel to the axis of rotation. The cylinder rotated so slowly* that no centrifugal effect was produced on the plants; but rapidly enough to destroy all geotropic action. The seedlings were therefore entirely free to obey the stimulus of light; and their heliotropic curvature was not liable to be influenced by gravitation, as is the case under ordinary circumstances. The principle on which the stimulus of gravitation can be avoided has

* One revolution in 20' in my experiments.

been fully discussed by Sachs in his paper, "Ueber Ausschliessung der geotropischen und heliotropischen Krümmungen" *. The history of the subject is there given; and a quotation from Sachs's 'Experimental Physiologie' (1865) shows that the principle of slow rotation was fully understood by him at that time. He points out (p. 107†) "that before any curvature, and before a perceptible amount of growth could occur" . . . the plant "would be in a reversed position." Thus any tendency to curvature which had been generated in the first position would be destroyed in the second position, and the plant would have no geotropic tendency of any kind.

Sachs is acquainted with John Hunter's experiments only as quoted by Dutrochet, and has not been able to see the original paper. And as Dutrochet quite misrepresents Hunter's meaning, it may be worth while to show that Hunter had a clear conception of the principle of slow rotation. He describes the means by which a basket of earth containing germinating beans was made to rotate, and goes on to say that the root of a bean had met with a small stone in its course, and had been turned by it into the direction of the axis of rotation, and had then *gone on in a straight line in that direction*. "Here, as there was no fixed inducement to grow in any one direction, the bean grew in a straight line in that direction given it by chance" ‡.

The above quotation has a merely antiquarian interest, the method of slow rotation as it exists in modern physiological research, and especially the ingenious application of it to the study of heliotropism, is entirely due to Sachs.

In describing the application of the principle of slow rotation to the study of plagiotropic organs, I shall employ Sachs's term *Klinostat* to designate the instrument by which plants are kept in slow rotation. And I shall employ this term to signify an apparatus either for the avoidance of geotropism alone, or of both heliotropism and geotropism §.

Fundamental Experiment.—If a plant whose leaves have the

* Arbeiten, Würzburg, Bd. ii. Heft ii. p. 209.

† Quoted by Sachs in his Arbeiten.

‡ Quoted from Hunter 'On the Blood' (1794), in the Catalogue of the Physiological Series of Comparative Anatomy in the Museum of the Roy. Coll. of Surgeons, vol. v. 1840, p. 12.

§ For the detailed description of the klinostat used in my experiments see Appendix.

power of placing themselves at right angles to incident light is growing normally in the open air and lighted from above, its leaves will be horizontal. Let the plant be now made to rotate on a klinostat so that the axis of rotation coincides with the axis of the plant. Also let the direction of the incident rays of light be parallel to the axis of rotation, so that the morphologically upper side of the leaves is illuminated by rays striking them at right angles, just as they were when the plant grew on the ground. Then, if the normal horizontal position is the result of a balance between geotropism (positive or negative) and any other force—epinasty, hyponasty, positive or negative heliotropism—it is clear that, geotropism being destroyed by the rotation, the balance cannot be maintained.

If, on the other hand, the horizontal position of leaves is due to transverse heliotropism (or diaheliotropism*), there is no reason why the leaves should not remain at right angles to the incident light. The stimulus which determines the position of the leaves is still the same, since the light is still at right angles to the surface of the leaf. Experiments planned after this type have been carried out on several plants with various results, as will be shown in detail.

Definition of Terms.

Light parallel to axis.—In describing the fundamental experiment I spoke of the direction of the light as parallel to the axis of the klinostat. In the actual experiments the klinostat stood close to a window, so that at any given moment the light struck the plants on the klinostat obliquely; but as the plant was in continuous rotation about an axis perpendicular to the panes of glass in the window, it is obvious that the light would be practically parallel to the axis.

Let x and y , fig. 3, be the cotyledons of a seedling plant (with hypocotyl h) growing in a box of earth, B , which is fixed to the end of the spindle of the klinostat kk . Let the arrow 1 in fig. 3 represent the direction of the light striking the leaf x ; now let the klinostat rotate through half a turn, so that x is downwards, fig. 4, and now the arrow 2 will represent the direction of the light; so that x will be equally exposed to light in the direction of the two arrows 1 and 2 in fig. 4, the resultant being

* This term has been proposed, in 'The Power of Movement in Plants,' as more convenient.

Fig. 3.

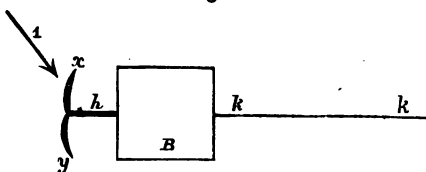

Fig. 4.

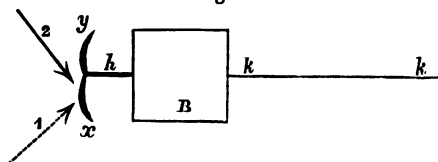

Diagram illustrating the rotation of a plant on the klinostat.

$k k$, the spindle of the klinostat; B , the box in which the seedling grows; h , the hypocotyl of seedling; x and y , its cotyledons.

Fig. 4 represents the change which occurs after the klinostat has rotated through half a turn. The arrows show the direction of light (see text).

In this and all subsequent drawings where $k k$ and B occur, the plane of the paper represents a vertical plane; the plane of the table on which the klinostat stands would therefore be at right angles to the plane of the paper.

equivalent to illumination parallel to the axis of rotation. In the greater number of experiments the klinostat was placed close to a (north) window, outside which a large (92 × 92 centims.) oblique mirror was fixed, so as to reflect as much light as possible horizontally into the room. When seedling radishes or cabbages, which are highly sensitive to lateral light, are placed on the klinostat in the position shown in figs. 3 and 4, the hypocotyls continue to grow parallel to the axis of rotation, showing that the efficient light is practically parallel to that axis. And in this sense I shall use the expression "*light parallel to axis of rotation.*"

Zenith position.—The position shown in figs. 3 and 4 is therefore equivalent to what would be illumination from above if the plant were growing in the normal position. I shall therefore call this position (when the axis of the plant is parallel both to the axis of rotation and to the incident light) the "*zenith position.*" If the under surfaces of the leaves are illuminated while the axis of the plant is parallel to the axis of rotation and to the light, the plant is said to be in the *nadir* position.

Lateral position.—The position shown in fig. 5, in which the spindle of the klinostat is still parallel to the incident light, but the axis of the plant is perpendicular to the axis of rotation, is equivalent to a strictly lateral illumination if the plant were not on the klinostat, and is called the “*lateral position.*”

Fig. 5.

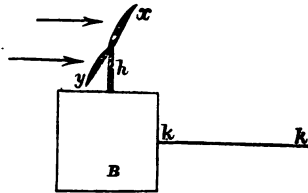

Diagram illustrating the “lateral position.”

kk, spindle of klinostat; *B*, box; *h*, hypocotyl; *x*, *y*, cotyledons; the arrows give the direction of incident light.

The other possible positions are when the axis of the plant is either parallel or perpendicular to the axis of rotation, and the axis of rotation is perpendicular to the incident light. These are the positions in which, as Sachs has shown, geotropic and heliotropic curvatures are both excluded.

Fig. 6.

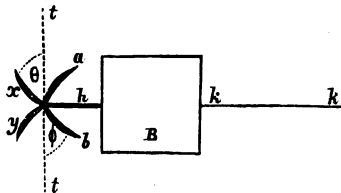

Diagram illustrative of the terms “transverse plane” &c.

kk, *B*, *h*, as in fig. 5; *tt*, the transverse plane; *a*, *b*, cotyledons making an angle ϕ behind the plane *tt*; *x*, *y*, cotyledons making an angle θ in front of *tt*.

Transverse plane is the plane at right angles to the axis of the plant. In fig. 6, if *h* is the hypocotyl of a seedling plant, *tt* is the transverse plane. If the cotyledons are bent back towards the stem of the plant as shown at *a* and *b*, then they are said to be behind the transverse plane. The cotyledons *x* and *y* are in front of the transverse plane. All angles in front of the trans-

verse plane are written with a + sign, those behind it with a - sign. When the plant is growing the right way up, not in the klinostat, I have given the angles as above and below the horizon, which in this case of course coincides with the transverse plane.

Diaheliotropic plane.—The expression diaheliotropism has been used by my father (*op. cit.* p. 438) as a more convenient term than any equivalent of the German "*Transversal-Heliotropismus*," to mean the power possessed by leaves of placing themselves "more or less transversely to the light." In accordance with this terminology, I shall call the plane at right angles to the incident light the *diaheliotropic plane*; and leaves in this plane may be said to be in the *diaheliotropic position*.

Upper and lower.—These terms applied to leaves mean, of course, the morphologically upper and lower sides.

Normal and inverse positions.—When the plant is not on the klinostat, but growing naturally, it is said to be in the normal position when the axis of the plant is vertical and the stem above the root. If the plant is upside down with its axis vertical, it is said to be in the *inverse position*.

Experiments with Ranunculus Ficaria.

These plants were especially well adapted for my experiments, being excessively common, and obtainable at an early period of the year, when many plants refuse to flourish properly. Moreover they grow healthily indoors under the conditions to which it was necessary to subject them. The method which I adopted consisted in wrapping the roots in damp cotton-wool, and covering this with an envelope of sheet india-rubber. Under these conditions the plants remained perfectly healthy, and put out numerous young leaves. The roots of the plant could then be tied on to a large pin; and this could then be fixed in various positions into a cork disk attached to the klinostat; and thus the plant could be illuminated from above, or below, or laterally, as might be desired. In other experiments, not made on the klinostat, the plants were fixed to the cork lining of the cover of a jar which was partly filled with water. They were thus cultivated in damp air, in the manner employed by Sachs in his experiments on bean-roots. In other cases the plants were grown with their roots in vessels of water. Lastly, other plants were simply grown in flower-pots.

Frank*, in his 'Wagerechte Richtung von Pflanzentheilen,' pp. 45, 46, speaks of the leaves of *R. Ficaria*, in common with a number of other radical leaves, as tending to place themselves at right angles to the light when laterally illuminated; the leaves which point away from the light rising up, while those directed towards it sink, so that both approach the diaheliotropic plane.

It was necessary to convince myself that plants indoors placed close to a window receive enough light to cause the leaves to be approximately at right angles to the incident light.

Experiment 1.—

TABLE I.

Date.	Leaf i.	Leaf ii.
	Lamina	Lamina
March 27, 9.20 A.M.	+15 ⁰ †	+15 ⁰
March 28, 2.30 P.M.	+30	+20
March 30	- 6	+50
April 2	-30	+40

A plant whose leaves i. and ii. were both 15° above the horizon was placed, March 27th, so that the underside of i. was towards the light; its position was close to a window, so that the illumination was oblique from above. It will be seen that i. ultimately curved downwards and ii. upwards, the movement in both cases being such as to improve the illumination—that is, to make the leaves more nearly at right angles to the light.

Experiment 2.—April 17th, 4 P.M. A plant, whose leaves were pressing epinastically against the ground, was dug up; and on being freed from the resistance of the soil, the leaves, as is usually the case, sprung back so as to point vertically downwards †. The plant was then fixed on the klinostat in the "zenith position" (see p. 427); so that the leaves pointed directly away from the light §.

* The fact of the leaves of *R. Ficaria* being apogeotropic in the dark, which Frank mentions (p. 46), I also confirmed. The rising of the leaves occurs long before the leaves are etiolated; so that the experiment is not open to the objection that the plant was in too abnormal circumstances.

† + means in front of the transverse plane, which in this case is equivalent to above the horizon.

‡ *R. Ficaria* exhibits this movement in the same way as *Pinguicula*, *Plantago*, &c.

§ It should be noted that when the plant is in the zenith position, as in this case, the transverse plane coincides with the diaheliotropic plane, so that ±0° means at right angles to the light.

TABLE II.*

Date.	Leaf i.		Leaf ii.		Leaf iii.	
	Lamina.	Petiole.	Lamina.	Petiole.	Lamina.	Petiole.
April 17, 4 P.M. } April 19, 8.25 A.M. } April 20, 8.45 A.M. }	-90 ^o ca	-90 ^o ca	-90 ^o ca
	+10	+20 ^o	-25	+10 ^o	-20	-20 ^o
	± 0	+20	± 0	+15	-12	-22

Thus two of the three leaves had gained the diaheliotropic plane" (that is, became at right angles to the light, see p. 429), and the third leaf (iii.) was only 12° behind that plane.

This experiment proves that the leaves are able to place themselves at right angles to the light without the aid of apogeotropism†. If when the plant is not on the klinostat, but growing in the normal position, the horizontal position is the result of apheliotropism balanced by apogeotropism, then in the above experiment (Exp. 1) the leaves ought to have remained in the position -90° into which epinasty had brought them—that is, the petiole and lamina pointing away from the light.

But it may be objected that epinastically bent leaves tend to recover a normal position independently of the direction of light. The following experiment shows that this is not the case.

Experiment 3.—A plant, whose leaves were bent epinastically backwards, was pinned (April 6th, 3.8 P.M.) inside a tin box; so that the plant was in complete darkness. The positions of the leaves having been noted, the box was fixed to the klinostat so that the axis of the plant was parallel to the axis of rotation.

TABLE III.

Date.	Leaf i.		Leaf ii.		Leaf iii.	
	Lamina.	Petiole.	Lamina.	Petiole.	Lamina.	Petiole.
April 6, 3.8 P.M. } April 9, 11.30 A.M. }	-50 ^o	-50 ^o	-80 ^o	-80 ^o	-80 ^o	-30 ^o
	-85	-50	-95	-70	-90	-35

* Where the measurements were for any reason taken somewhat roughly, *ca*, abbreviation for "circa" = "about," is added, as in the upper line of Table II.

† *R. Ficaria* sometimes exhibits well-marked sleep movements of the younger leaves, which rise far above the horizon at night. These movements were well

It will be seen that, instead of diminishing, the epinastic curvature increased in all three cases. The tin box was then removed from the klinostat, and placed so that the plant was in the normal position; in a few days leaves i. and ii. (iii. was not noted) were well above the horizon, showing that their behaviour during the rotating was not due to cessation of growth.

It has now been proved that the antagonism of apogeotropism and apheliotropism is not necessary to the plant. But it may be said that, as the leaves are undoubtedly strongly epinastic, the balance may be due to the equality of epinasty on one side, and apogeotropism aided by positive heliotropism on the other. The following experiment disproves this view.

Experiment 4.—A plant was dug up on April 29th, 9.27 A.M., with a large ball of earth attached, so that the leaves were unable to bend backwards. The plant was placed in the dark until the leaves had become somewhat raised above the horizon; it was then placed on the klinostat in the zenith position, so that the leaves were pointing towards the light (April 29th).

TABLE IV.

Date.	Leaf i.	Leaf ii.	Leaf iii.	Leaf iv.
April 29, 9.27 A.M.	Lamina +90° <i>chd</i> *	Lamina +24°	Lamina +45°	Lamina +45°
April 30, 8.30 A.M.	+45	-23	+20	- 7
May 30, 3.30 P.M.	+25	- 5	+ 5	{ twisted sideways.

This (though not a very complete experiment) shows clearly enough that the leaves are not heliotropic, since they all at first curve away from the light; by glancing down any one of the columns headed "Lamina," it will be seen that all the angles become smaller, and in some cases the sign changes. In other

executed when the plant was on the klinostat, showing the existence of power of curving forward. It need hardly be said that I took care not to be deceived by the sleep-movements in estimating the movements with regard to the direction of incident light.

* *chd* means that the organ measured was so much curved that it was only possible to measure the angle made by the chord of its arc with the transverse plane.

words, they bend backwards away from the source of light and towards the diaheliotropic plane (see p. 429). Leaf ii. was 23° behind the diaheliotropic plane on April 30th; but by May 4th this angle had again diminished to -5° .

In the foregoing experiments all the leaves on a given plant have behaved in a similar manner. In the following experiment we have experiments 1 and 3 repeated on a single plant.

Experiment 5.—A plant having been subject to lateral illumination, was placed April 7th, 11.30 A.M., in the zenith position.

TABLE V.

Date.	Leaf i.		Leaf ii.	
	Lamina.	Petiole.	Lamina.	Petiole.
April 7, 11.30 A.M. } ...	+52°	+52°	-15°	± 0 ca
April 9, 11 A.M. } ...	+23	+55	-10	-10
April 9, 11.10 A.M.* } .	+18	+50	- 5	- 5
April 14, 8.15 A.M. } .	+20	+35	± 0	± 0

It will be seen that on April 9th leaf i., which had been far in front of the diaheliotropic† plane, had begun to move back towards it, and leaf ii. had begun to move from behind the transverse plane also towards it. The plant had to be removed and refixed on the klinostat, so that both leaves were brought 5° nearer the transverse plane. By April 14th the lamina of i. was at about the same angle ($+20^\circ$), though the petiole had bent backwards. Both lamina and petiole of ii. had reached and remained in the diaheliotropic plane.

Experiment 6.—Another similar experiment may be given. A plant which had been exposed for some days to a lateral illumination was (April 2nd, 3.45 P.M.) placed in the zenith position.

* The plant was removed at 11 A.M. April 9, and replaced not exactly in the same position.

† When a plant is in the zenith position, the diaheliotropic plane coincides with the transverse plane.

TABLE VI.

Date.	Leaf i.		Leaf ii.	
	Lamina.	Petiole.	Lamina.	Petiole.
April 2, } 3.45 P.M.	-80°	-25°	+60°	+45° <i>chd</i>
April 5, } 4.30 P.M.	-20	*- 8 <i>chd</i>	+15	+30 <i>chd</i>
April 6, } 10.20 A.M.	-10	- 7 <i>chd</i>	+ 6	+30

* For explanation of *chd*, see note to Table IV.

This experiment shows that one leaf may approach the diaheliotropic plane by moving away from the light, while another on the same plant may do the same by moving towards it. It shows once more that the leaves of *Ranunculus Ficaria* place themselves at right angles to the light when freed from the stimulus of gravitation.

The following experiments show the power possessed by the leaves of adapting themselves to lateral illumination.

Experiment 7.—A plant was placed (March 25th) in the lateral position on the klinostat before a south-west window, where it was shaded as far as possible from direct sunlight in the evening. Leaf i. pointed (*i. e.* the axis of the petiole and of the midrib was directed) nearly towards the window ; ii. pointed away from the window.

TABLE VII.

Date.	Leaf i.		Leaf ii.	
	Lamina.	Petiole.	Lamina.	Petiole.
March 25, } 3 P.M.	- 3°	- 3°	-60° <i>ca</i>	-10°
March 27, } 6.15 P.M.	-45°	+45
March 28, } 9.55 A.M.	-80°	-30°	+42°	+42

Thus leaf i. bent epinastically downwards until the lamina was -80°, which, when the plant is in the *lateral* position, is nearly at right angles to the light. The lamina of leaf ii. moved through more than 100° in its attempt to reach the diaheliotropic plane.

Fig. 7.

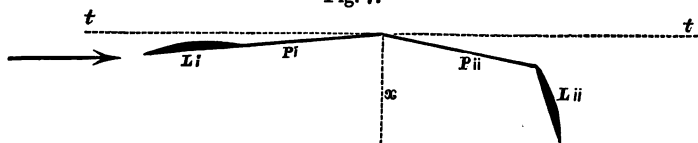
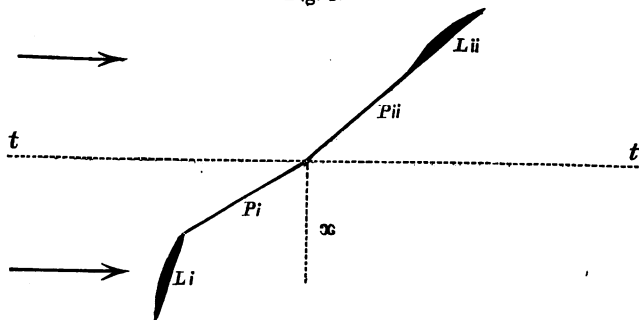

Fig. 8.



Diagrams illustrating Experiment 7.

Fig. 7 shows the position of the leaves on March 25; fig. 8 on March 28: tt , the transverse plane; x , the axis of the plant; Pi and Pii the petioles of leaves *i.* and *ii.*; Li and Lii the laminae. The arrows give the direction of the light.

These movements are shown in the diagrams: fig. 7 represents the position of the leaves on March 25th; fig. 8 on March 28th.

Another similar experiment gave somewhat different results. In this case it was the leaf pointing towards the light (corresponding to Li in fig. 7), which failed to place itself exactly in the diheliotropic plane, though it moved in the right direction.

Experiment 8.—A plant had been grown a short time in the dark, and was not etiolated; the two youngest leaves (*i.* being the older) had grown up highly inclined above the horizon. It was then (April 2nd) placed on the klinostat in the lateral position with the morphologically under surface of *i.* facing the light. It will be seen that both leaves began to curve in the epinastic direction, *i.* curving towards the light and *ii.* away from it. The positions which the leaves ultimately assumed at the end of the five days during which the experiment lasted are not in the diheliotropic plane; to reach this, *i.* would have to move from -15° to -90° , and *ii.* from $+52^\circ$ to $+90^\circ$. It is unfortunate that the experiment was not continued longer, as the leaves would possibly have become more truly at right angles to the light. It

TABLE VIII.

Date.	Leaf i.		Leaf ii.	
	Lamina.	Petiole.	Lamina.	Petiole.
April 2, 10.52 A.M. } April 3, 9.30 A.M. } April 5, 4.25 P.M. } April 7, 11.21 A.M. }	+90 ^o *	+80 ^o	+70 ^o	+80 ^o
	+ 5	+63	+57	+74
	-12	+22 <i>chd</i>	+25	+40
	-15	+20 <i>chd</i>	+52	+52

The angles here given were measured by stopping the klinostat when the plant was in the normal position, and measuring the angles above (+) and below (-) the transverse plane, *tt*. The axis of rotation and the direction of the light being parallel to *tt*, the leaves will be at right angles to the light when leaf i. is at -90° , and leaf ii. at $+90^{\circ}$.

should be noted that in the case of i. it cannot be the absence of apogeotropism which caused the failure to reach the diabeliotropic plane, since epinasty unopposed by apogeotropism would tend to bring it more easily into that position than if gravitation were acting on it. It is also clear that ii. could not have remained in its final position if it were dependent on apogeotropism; and it is therefore certain that some other force arrested the epinasty of ii. This experiment ought to be compared with the result of absolutely lateral, *i. e.* not oblique, illumination on a plant of *Ranunculus Ficaria* growing under the influence of gravitation in the normal position; but this unfortunately was not done. The results of experiments 7 and 8 show clearly that a leaf can move either in the epinastic or hyponastic directions, and that these movements are produced and checked by the stimulus of light, and without the stimulus of gravitation, in such a way that a plant *tends* to place its leaves at right angles to the light, though it may not perfectly succeed in doing so.

Experiment 9.—These observations show the effect of illuminating the under surfaces of the leaves.

TABLE IX.

Date.	Leaf i.	Leaf ii.
	Lamina	Lamina
April 2, 11 A.M.	- 45	- 35
April 5, 4.30 P.M.	-110	-120
April 7	- 90	- 80

On April 2nd, the leaves being 45° and 35° behind the transverse plane, the plant was fixed on the klinostat in the nadir position (p. 427). On April 5th the leaves had curled round in consequence of continuous epinasty, so that the upper surfaces were, as shown in fig. 9, partly illuminated. What was the meaning of the subsequent movement which occurred on April 7th I cannot say; but as it occurred on both leaves, it is perhaps worth giving: the consequence was that the leaves pointed towards the light.

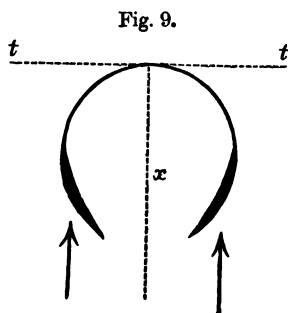

Diagram illustrating the position of the leaves on April 5th, Table IX. The arrows show the direction of the incident light.

Experiments with Beans (Vicia Faba).

A very young plant was transplanted (May 17th) from the open ground and kept under a bell-glass in the greenhouse for a couple of days, during which time it was subjected to a rather dull light from above. On May 19th (10.30 A.M.) two of the leaves were 38° and 41° above the horizon, and the plant was placed on the klinostat in the zenith position. On May 21st, 8.26 A.M., one leaf was $+16^\circ$, the other -2° . The experiment having been made to observe the "sleep" movement of the bean on the klinostat, was not continued any longer. There was evidence of power of bending in front of the transverse plane independently of apogeotropism; that is to say, the plants performed their sleep movements while on the klinostat.

The same experiment was repeated in the autumn. On Oct. 27th, 9.20 A.M., a plant 15 centim. high was removed from a shady part of a cool greenhouse and fixed on the klinostat in the zenith position. The two leaves next below the bud were chosen for observation, i. (the younger leaf) being at $+62^\circ$, ii. at $+15^\circ$. On Oct. 29th, 9.20 A.M., leaf ii. was -15° , on the same day in the evening (6.50 P.M.) at $+12^\circ$, the change being due to "sleep movement,"

and showing the existence of a power of moving towards the front of the transverse plane. On Nov. 4th it was -30° at noon, and it only rose to $+2^\circ$ by 11 P.M.; and on Nov. 6th it was still -25° at 12.50 P.M. Leaf i. was, on Nov. 6th, at 12.50 P.M. at -40° .

These facts show that the leaves of the bean are not able to remain at right angles to light while rotating on the klinostat; but the length of time required to drive back the leaves behind the diaheliotropic plane shows that there is a *tendency* to remain in that plane in spite of the absence of apogeotropism.

In another similar experiment the two leaves under observation were—i. at $+48^\circ$, ii. at $+57^\circ$; and the plant was then (Oct. 29th, 4.5 P.M.) placed in the zenith position at a north window which had no oblique mirror. On Nov. 8th, 10.13 A.M., it was found that the stem had become able to bend so that the leaves did not occupy the same positions with regard to the transverse plane in all parts of the revolution. The two extreme positions were—for leaf i. -8° and -20° , for ii. $+15^\circ$ and 20° . The stem was then tied to a new support, so that (i.) was at -8° , (ii.) at -5° . The same evening (Nov. 8th) the leaves rose to $+31^\circ$ and $+33^\circ$; and next day at 12.30 P.M. they were both at $+12^\circ$. They may therefore fairly be said to be still approximately in the diaheliotropic plane after eleven days on the klinostat. It should be remarked that experiments made at this time are not satisfactory, since the plants do not receive a normal amount of light.

Experiment with the Vegetable Marrow (Cucurbita ovifera).

On Nov. 1st, 10.11 A.M., a seedling whose hypocotyl was 7 centim. in length, was placed in the zenith position on the klinostat in the greenhouse. The cotyledons (called *left* and *right*) were both in front of the transverse plane, *left* $+15^\circ$, *right* $+45^\circ$. On Nov. 10th, 11.20 A.M., the cotyledons were curled backwards epinastically, the main part of the left cotyledon was $+35^\circ$, and the chord made by the right one was at $+20^\circ$. On Nov. 16th, 9.20 A.M., the left cotyledon was $+10^\circ$, the right $+13^\circ$. Thus after fifteen days on the klinostat the cotyledons were approximately at right angles to the light.

Experiment with the Plantain (Plantago media).

A plant growing in a box was placed in dull light for three or four days; and on July 2, 6.40 P.M., the angles made by the chords

from the base to the apex of three leaves were ^{i.} +70°, ^{ii.} +66°, ^{iii.} +34°; the plant was then placed on the klinostat in the zenith position at a north window. It remained in rotation till July 13, 10.30 A.M., when the leaves were at ^{i.} +25°, ^{ii.} +25°, ^{iii.} +30°, showing that ageotropism is not needed to keep the leaves even somewhat in front of the diaheliotropic plane.

Experiments with Cherries.

The plants used in these experiments were seedlings, having woody stems about 10 centim. high; the terminal buds developed into healthy green stems, and produced vigorous leaves in the course of the summer months, during which the experiments were carried on. The plants were grown in earth in the above-mentioned small wooden boxes, or in small flower-pots, which could easily be fitted on to the klinostat.

Some preliminary experiments were made on the behaviour of cherries growing, not on the klinostat, but in the normal position, to ascertain the way in which they react to light and gravity in various combinations*.

When lighted from above, the leaves of the seedling cherry-trees assume a position either a few degrees above or below the horizon. The young leaves are at first highly inclined (+60° or +70°), and bend epinastically down in the natural course of growth until they reach the horizontal position.

Experiment 1 (Table X.).—The first experiment was made to find out whether the leaves of the cherry can adapt themselves to lateral illumination. A plant had two leaves opposite to each other, the lamina of leaf i. being 8° above, that of leaf ii. being 70° below the horizon.

TABLE X.

Date.	i. Lamina.	ii. Lamina.
May 20	+ 8°	-70°
May 24	-40	+53

It was then (May 20th) put close to a window, leaf i. pointing

* Seedling plants of oak and horse-chestnut were also tried, but were not found sufficiently sensitive to gravity or light to be useful plants for the experiments.

towards the light; and it will be seen that i. sunk and ii. rose, both therefore approaching the diaheliotropic plane.

When a cherry-plant is placed in the normal position in the dark, it behaves very differently from *Ranunculus Ficaria*, whose leaves bend apogeotropically upwards when released from the stimulus of vertical light which keeps them horizontal. Under similar conditions the leaves of the cherry remain almost in unaltered positions, and certainly exhibit no such well-marked rising as occurs in *R. Ficaria*, and, according to Frank, in other radicle leaves*.

Experiment 2 (Table XI).—A plant whose leaves had been epinastically curved downward in a way to be presently described, was placed in a tall cylinder blackened inside, where the light was faint enough to cause seedling-cabbages growing in it to be “drawn up.” This was done on the morning of May 12th, after the angles given below had been measured. It will be seen that by the next evening there had been a considerable rise, owing to apogeotropism; and if the experiment had been on *R. Ficaria*, the apogeotropic movement would have been continued and the leaves would have become nearly vertical. But although the plant was now (May 13th, 6.45 P.M.) put in the dark until May 17th, the leaves did not become much raised above the horizon, and some went slightly below it.

TABLE XI.

Date.	Leaf i.	Leaf ii.	Leaf iii.	Leaf iv.	Leaf v.
May 12, 8.33 A.M.	-32°	-30°	-15°	-47°	-28°
Now (May 12th) placed in dull light.					
May 13, 6.45 P.M.	-27	-11	-4	-0	+27
Now (May 13th) placed in the dark.					
May 17, 10.20 A.M.	-0	+9	+7	-20	-7

In another experiment a plant growing out of doors, and having three approximately horizontal leaves, was placed in the dark in the afternoon of May 4th; it remained in the dark till the morning of May 7th; and the leaves exhibited no rising, but, on the contrary, sank to 12°, 28°, and 25° below the horizon.

* Frank does not mention the cherry; he says that the leaves of trees vary in their behaviour when placed in darkness.

(Experiments with the Klinostat.)

Experiment 3 (Table XII.).—The plant was grown in a small pot out of doors, and was a seedling with a woody stem 9 centim. high, with a bunch of eight leaves budding out at the top and other (older) leaves growing on the woody stem. On April 26th, 4 p.m., it was fixed in the zenith position at a north window, the large mirror being in front as above described. The angles in the following table were generally taken by removing the spindle of the klinostat with the plant attached, and measuring the angles at which the leaves stood when the plant was in the normal position.

TABLE XII.

Date.	i. Lamina.	ii. Lamina.	iii. Lamina.
April 26, 4 P.M. }	+ 3°	+15°	+18°
April 26... }	After the above measurements were taken, it was placed in the zenith position.		
April 28, 8.20 A.M. }	-14	-13	+ 3
April 30, 8.40 A.M. }	-21	-25	- 7
May 4, 3.6 P.M. }	-57	-70	-35

It is clear from this experiment that the leaves of the cherry are not able to remain even approximately at right angles to the light when on the klinostat; for it will be seen that all the three leaves curved strongly towards the stem. It appears that, in order to remain in the diaheliotropic plane, some force is wanted to oppose the tendency of the leaves to curve towards the stem. Therefore the cherry behaves in a markedly different manner from *Ranunculus Ficaria*; for the latter is able to keep its leaves in the diaheliotropic plane when grown on the klinostat, and without the assistance of apogeotropism to act as an opposing force.

Experiment 4 (Table XIII.).—The same plant was next, May 4th, 3.10 p.m., removed from the klinostat and placed in the normal position in the dark; and by the following morning (May 5th) the leaves had risen apogeotropically.

TABLE XIII.

Date.	i. Lamina.	ii. Lamina.	iii. Lamina.
May 5, 8.15 A.M. } ...	-20°	-30°	-20°
May 5, 8.15 A.M. } {	After above measurements, plant was fixed on klinostat and kept in the <i>dark</i> .		
May 7, 8.30 A.M. } ...			

It was then (May 5th) placed on the klinostat in the dark; and it will be seen that the leaves bent backwards towards the stem; and as this occurred in the dark as well as in the light, it proves that it is epinasty, and not apheliotropism, which causes the movement.

The experiment being continued, gave the same results as those in Experiment 3. When the plant was placed in the normal position, either in light or darkness, the leaves rose and approached the horizontal plane. When again placed on the klinostat in the light in the zenith position, the leaves bent epinastically, so as to become more nearly parallel to the stem, and could again be brought up through the action of apogeotropism by removing the plant from the klinostat and placing it in the normal position.

Other experiments were made with plants in the lateral position. The following may serve as an example.

Experiment 5 (Table XIV.).—The plant with which experiments 3 and 4 were made was placed for a few days (June 27th to 30th) at a window so as to be illuminated obliquely from above.

TABLE XIV.

Date.	i. Lamina.	ii. Lamina.	iii. Lamina.	iv. Lamina.
June 30, 8.47 A.M. } ...	+71°	+ 3°	-29°	+35°
June 30, 8.47 A.M. } {	After the above measurements, the plant was placed on the klinostat in lateral position, so that the same side of the plant was towards the light, as from the 27th to the 30th.			
July 1, 8.20 A.M. } ...				
July 2, 8.30 A.M. } ...	- 5	-90	-90	-25

Leaves Nos. i. and iv. are the ones which pointed away from the light; and if the plant had remained laterally illuminated in

the normal position and not on the klinostat, these two would have remained above the horizon; being, however, on the klinostat and freed from the influence of apogeotropism, they became epinastically bent like the leaf iii., which pointed towards the light, and whose original angle beneath the horizon was much increased; leaf ii. grew out parallel to the glass of the window—that is, halfway between those which pointed towards and those which pointed away from the light; its epinastic curvature was also large*.

Experiment 6 (Table XV).—In another similar experiment, the leaf which was pointing away from the light, and which was above the horizon, remained in this position when the plant was placed on the klinostat, while the leaf which pointed to the light, and was below the horizon, became strongly curved. The following table gives the angles.

TABLE XV.

Date.	i. Lamina.	ii. Lamina.
May 17, 9.25 A.M....	+55°	- 11°
May 18, 10.30 A.M....	+55	- 65
May 19, 9.40 A.M....	+55	- 118

The plant was fixed on the klinostat in the lateral position May 17th, 9.25 A.M., and the angles immediately taken. Leaf i. pointed away from the window, so that its upper surface was directed towards the light. It must not be supposed that the non-curvature of leaf i. resulted from any loss of epinastic power in its petiole; for after the observations recorded on May 19th the plant was removed from the klinostat, and on May 20th it was placed in the normal position, but in a reversed position as regards light; that is, leaf i. was made to point towards the light: under these circumstances it became curved, and was at 8° below the horizon on May 22nd, and 40° beneath it on May 24th.

It seems, therefore, that the stimulus of light was sufficient in

* It is hardly necessary to state that, in all cases where it was necessary, the heliotropic curvatures of the stem were prevented by tying it to a stick fixed in the pot.

this instance to keep the leaf in its previous position without the aid of apogeotropism, which in all the other experiments seemed to be needed as an antagonist to epinasty.

Sources of Error.—Before summing up the results of the experiments with cherries, it will be well to point out a source of error, which, however, does not vitiate the results given. On June 9th, after a cherry-plant had been rotating in the zenith position during my absence from home, since May 26th, it was noticed for the first time that the stem, which had grown much in my absence, was flexible, and bent with the weight of the leaves, so that it did not remain horizontal, but was constantly inclined at from 10° to 15° beneath the horizon in spite of the rotation of the klinostat. Thus the stem was always in the position shown in fig. 10, and consequently the leaves *ll*, arising from a flexible part of the stem, tended to bend apogeotropically towards the stem. If we make use of Sachs's method of estimating the strength of the geotropic stimulus as in some way proportional to the angle which the organ acted on makes with the line of gravity*, we shall see that the result of the flexibility of the stem is a small constant apogeotropic stimulus, tending to make the leaves bend backwards

Diagrams illustrating the result of the flexibility of the stem.

Fig. 10.

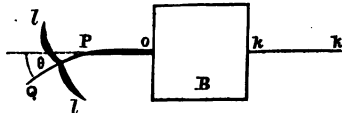

k k, axis of klinostat; B, box in which plant grows; *o P Q*, the flexible stem making an angle θ below the horizon.

Fig. 11.

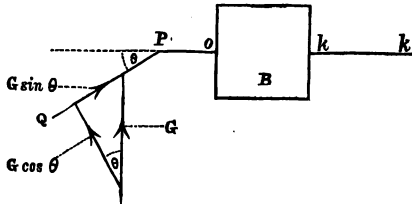

k k, axis of klinostat; B, box in which plant grows; *o P Q*, stem bent at P so as to make an angle θ below the horizon; G, the hypotenuse of the triangle, represents the force of gravity; $G \cos \theta$ and $G \sin \theta$ the resolved parts of G perpendicular and parallel to the stem P Q.

* 'Arbeiten,' Bd. ii. p. 240.

towards the stem of the plant (fig. 11). According to Sachs's diagram, let $o P Q$ be the stem of the cherry, which bends at the point P so as to make an angle θ beneath the horizon. Now, if the side G of the triangle represent the force of gravity, Sachs assumes that G may be resolved into its components $G \cos \theta$ acting at right angles to the stem $P Q$, and $G \sin \theta$ acting parallel to it. The arrows in the figure are drawn not in the direction in which gravitation acts, but to show in what direction the stem tends to move apogeotropically. Now the force $G \cos \theta$ acting at right angles to the stem will be constantly acting on different sides of the stem because of the rotation of the klinostat. But the force $G \sin \theta$ will act all the time parallel to the stem. If θ is a small angle, $G \sin \theta$ will be a small force. Consequently the plant will be in the same condition as if it were hung upside down (in the inverse position), only that, instead of the whole force of gravity, only a small part of the force will act on it; but the result will be a tendency in the leaves to bend backwards towards the stem; that is to say, this fraction of gravitation will assist epinasty. When I found out the flexibility of the stem, it occurred to me that the result which I had put down to epinasty might really be due to the weakened force of gravity acting on the leaves. I therefore repeated the experiment with plants whose stems were firmly tied to sticks stuck in the flower-pot, and found the results to be the same.

This precautionary experiment was in reality hardly needed; for I had observed the epinastic bending in several cases where there was certainly no flexibility of the stem.

In the case of large and heavy leaves, such as full-grown cherry-leaves, the influence of their weight on their position must be considered.

A plant whose leaves were at the following angles,

i.	ii.	iii.
-6°	$+11^{\circ}$	$+11^{\circ}$

was put in the inverse position, so that the stem hung vertically down; and now the angles of the leaves were

i.	ii.	iii.
-30°	-45°	-50°

This result is a consequence of the petiole being adapted to withstand the compression of its lower half when the plant is in the normal position; but the morphologically upper half

of the petiole not being adapted to withstand compression, yields when compressed by the plant being placed in the inverse position. When a cherry-plant is rotating on a klinostat, for instance in the zenith position (as shown in fig. 12), it is clear that there can be no tendency to curvature in the stem caused by the weight of the parts, since, owing to the rotation, there is no reason why the stem should curve in one direction more than another.

Fig. 12.

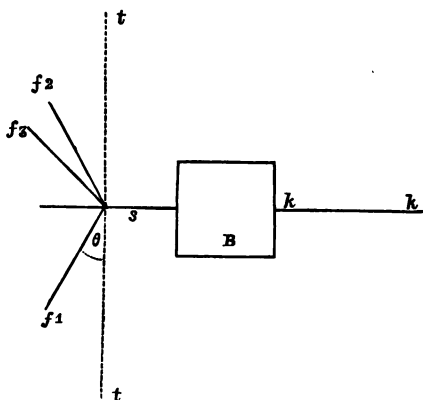

Diagram illustrating the effect of the weight of the leaves.

kk, axis of klinostat; *B*, box in which the stem of the plant grows; *tt*, the transverse plane; *f₁*, a leaf making an angle θ in front; *f₂*, the position *f₁* ought to occupy when the klinostat has made half a rotation; *f₃*, the position which it actually occupies, its weight having made it fall forwards.

The same thing would hold good with the petioles if they had symmetrical powers of resisting weight; but it has been seen that in the inverse position of the plant the compressing strain comes on the morphologically upper half of the petiole, which is normally subject to tension, and not compression. If, then, a leaf is slightly above the horizon when the plant is in the normal position, then, when the plant is placed on the klinostat, a leaf hanging down, such as *f₁*, will retain the original angle θ which it makes with the transverse plane, since the weight of the leaf is still compressing that half of the petiole which is able to bear compression. But when, owing to the rotation, the leaf assumes the position *f₂*, the weight of the leaf will be compressing that half of the petiole which is unable to resist it; consequently the leaf will fall forward into some such position as *f₃*. If the leaves were slightly below the

horizon in the normal position of the plant, the final result on the klinostat would be the same. The observation which fig. 12 represents was as follows. A leaf stood, in the normal position of the plant, 30° above the horizon or transverse plane; when the plant was placed on the klinostat, and the leaf was in the position of f_2 , it was 45° in front of the transverse plane ($+45^\circ$); when it was in the position f_1 , it was again $+30^\circ$. It seems clear, therefore, that the weight of the leaf tends during half a rotation to bring the leaf in front of the transverse plane, while during the other half rotation it produces no alteration in the normal position. The whole effect, therefore, of the weight of the leaf is to bring the leaf in front of the transverse plane, a result which is exactly the opposite of the effect which the weight of the leaf has when the plant is in the normal position; for then the weight tends to bring the leaves below the horizon, which would be equivalent to behind the transverse plane. From this it follows that the epinastic curvature of cherry-leaves, when the plant is on the klinostat, is work done *against* the effect of the weight of the leaves, whereas in the normal position epinasty works in conjunction with the effect of the weight of the leaves.

These facts and considerations are given to show that the influence of the flexibility of the stem and unsymmetrical rigidity of the petioles have been taken into consideration as elements in the problem.

Besides the experiments given with various kinds of leaves, a number of experiments were made with the creeping stems of *Lysimachia Nummularia*; but as I was unable to arrive at a definite general result, I have not thought them 'worth publishing at present.

Conclusion.

The principle on which the facts above given are most explicable is that given by my father in his recently published book*; I mean the principle that the chief movements of plants are modifications of circumnutation.

In the parts of plants which are capable of movement the longitudinal tension is continually changing in such a way that a circumnutating movement is produced essentially the same as the revolving nutation of climbing-plants, though much less in amplitude. In the case of leaves, the movements are chiefly due to changes in the longitudinal tension of the

* 'The Power of Movement in Plants,' 1880.

upper and lower halves of the petiole ; so that the circumnutation of a leaf consists chiefly of alternate hypo- and epinastic movements ; a leaf, therefore, which appears to be stationary in the horizontal position is in reality constantly oscillating up and down. Circumnutation is regulated by stimuli ; it is only when an organ is in its normal position with regard to external forces (light, gravitation, &c.), that circumnutation remains in a state of equilibrium, and the oscillations are so equalized that the mean position of the organ remains the same. If the organ is displaced, the altered stimuli of the external forces act on the circumnutation and bring back the organ to the position of equilibrium. If a seedling plant is lighted from above, and therefore growing vertically upwards, its apex will be oscillating about the vertical line. If the illumination becomes lateral, the plant will bend heliotropically, owing to the exaggeration of the oscillations towards the light, and the diminution of those away from it. In the same way, if the hypocotyl is prevented from bending, the cotyledons adjust themselves to the lateral light by a similar kind of modified circumnutation. The change of position which occurs under these circumstances is a rising of one cotyledon and a sinking of the other. The rising is usually considered to be an apogeotropic, and the sinking an epinastic curvature. This is not necessarily the case. Both rise and fall are more properly to be defined as exaggerations of circumnutating movements in these two directions, due to the stimulus of light.

The above experiments (especially those with *Ranunculus Ficaria*) support this view, since they show that there are powers of movement residing in the petiole which are under the control of the light-stimulus, so that the leaves can bend either towards or from the source of light, in order to reach the diaheliotropic plane. Besides light, other stimuli can alter the circumnutation of leaves ; their movements are affected by gravitation and by the internal impulses which give rise to epinasty and hyponasty. We may have three forces acting on the leaves—the epinastic stimulus, and those of gravitation and light. If the sensitiveness to light is great, the leaf will be able to obey this stimulus in spite of disturbances, such as the loss of the gravitation-stimulus. This is what occurs with *R. Ficaria*, with *Plantago*, and the vegetable marrow (*Cucurbita ovifera*). But in the case of the cherry the light-stimulus is not strong enough ; the plant, when growing normally, trusts to the opposing forces of epinasty and apogeotropism to produce an approximate balance, the final

result being determined by the light-stimulus. Therefore, when the plant is on the klinostat, where the balance between epinasty and apogeotropism is destroyed, the light-stimulus is not strong enough to keep the leaves in the diaheliotropic plane.

The cases such as that of the bean seem to be intermediate between those of *R. Ficaria* and of the cherry. There is evidence that the leaves can remain for a considerable time approximately at right angles to the light without the help of gravitation; but ultimately they may be forced by epinasty to relinquish the diaheliotropic plane.

Thus the result of the experiments with the klinostat is, on the whole, to confirm the view published in 'The Movements of Plants'*, that the power which leaves have of placing themselves at right angles to the incident light is due to a specialized sensitiveness to light—diaheliotropism, which is able to regulate or govern the action of other external forces such as gravitation, or of internal forces such as epinasty.

APPENDIX on the Klinostat used in the above Experiments, made after the design of Horace Darwin.

The klinostat † used in my experiments differs in construction from that of Professor Sachs, which I had the advantage of seeing in action in his laboratory. The principle on which my klinostats are constructed is entirely due to my brother, Horace Darwin; and they have been found to answer so admirably that a detailed description of the instrument may not be out of place ‡.

The spindle of the klinostat (that is, the axis of rotation about which the plant turns) does not form an integral part of the clock which supplies the motive power, but is merely connected with the clock by a loop of silk passing round two pulleys, one on the

* Pp. 438-444.

† The klinostat used by John Hunter (*loc. cit.*) was made on the principle of a water-clock. The beans which were used in his experiment were placed in a basket filled with earth; this was attached to a straight rod serving as a spindle, which was supported at either end by a notch in the rim of a large tub filled with water, which flowed slowly out through a minute hole close to the bottom of the tub. The rotation was communicated by a piece of string wrapped round the basket; to the free end of the string a floating weight was fastened; and as the weight sank the basket rotated, at the rate of about one revolution in eight hours.

‡ The instruments were made by the Cambridge Scientific-Instrument Company, 18 Panton Street, Cambridge.

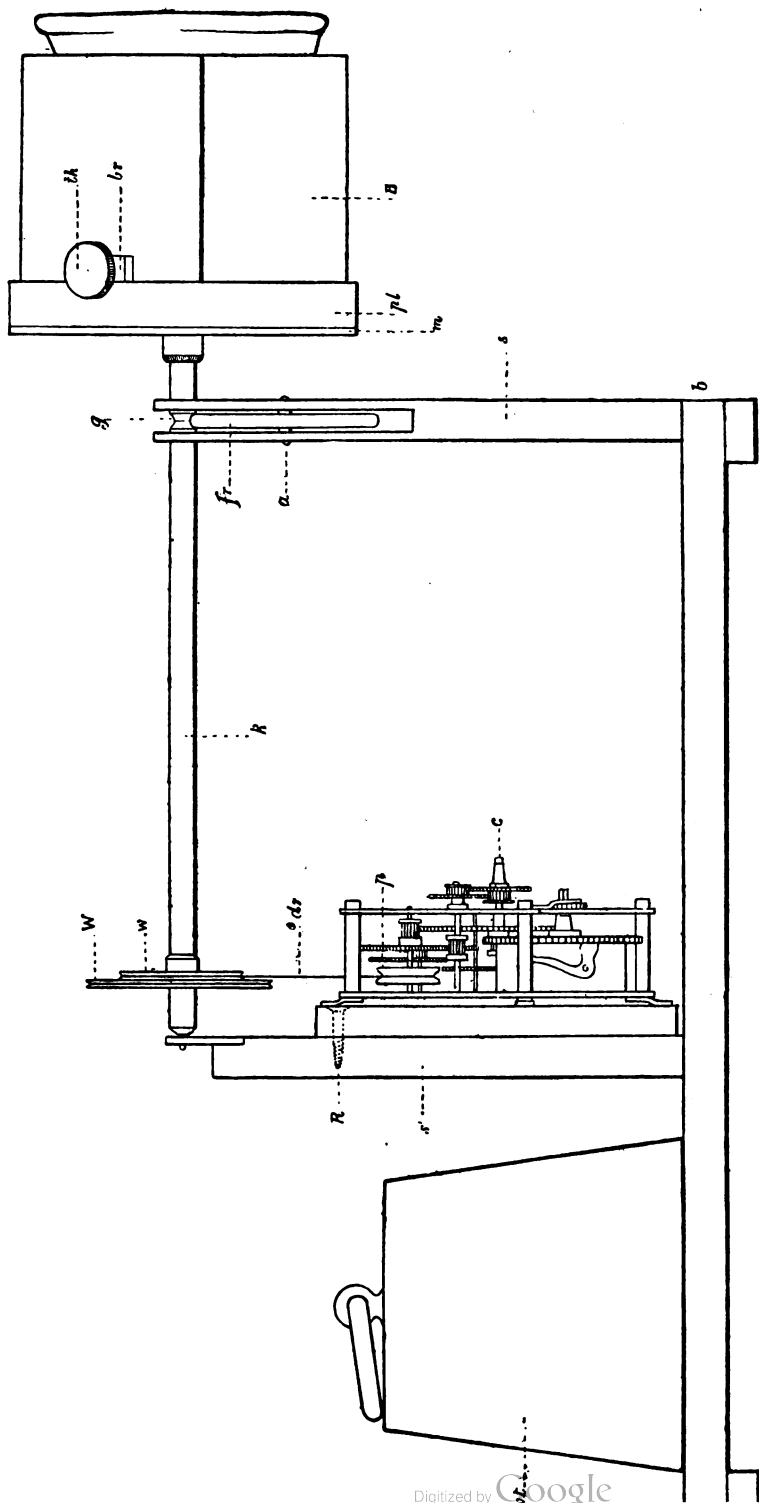

Fig. 13.—Diagram of the Kinostat, reduced, and exhibited in profile.

b, the board on which the instrument stands; *w*, weight used to counterbalance the weight of the plant; *s*, *s'*, the supports for the bearings; *k*, the spindle; *B*, the box in which the plant grows, or in which a flower-pot may be fixed, as here shown; *pl*, the wooden disk to which *B* is fixed; *m*, the metal plate shown in fig. 14 (*m*); *r*, one of two small blocks of brass between which *B* is fixed by means of a thumb-screw; *th*, thumb-screw; *W*, *w*, grooved pulleys fixed to the spindle; *p*, the

spindle of the klinostat, the other on the arbor of one of the clock-wheels. This principle has several advantages. The spindle can be instantly put out of gear by slackening the silk; the plant under observation can be at once removed without interfering with the clockwork. Another good point in the construction of the klinostat is that the plant is fixed to the free end of the spindle, which projects beyond the bearings, instead of in the middle; the shading* of the plants, which occurs if the plants are fixed to the middle of the spindle, can thus be avoided. As the plant is connected with the motive power by a spindle (*k*, fig. 13) only a centimeter in diameter, it can be covered with a properly constructed glass case, by which the air in its neighbourhood can be kept damp, while the clockwork will be in the dry air of the room. By means of a like arrangement I have kept the klinostat going for many weeks out of doors, the clockwork being in a box, the plant exposed to the open air. But the special advantage of my brother's design is the device by which the centre of gravity of the plant can be made to coincide with the axis of rotation of the machine, so that a very considerable weight can be easily driven by the clock. The box in which the plants are grown, or in which a flower-pot may be easily fixed, is shown at B (fig. 13). By means of a thumb-screw *th* the box can be attached to the wooden plate *pl*, which in its turn is fixed to the strong steel spindle (10 millim. diameter) *k'*, which forms the axis of rotation of the machine. The box is a cube, and can therefore be fixed in two positions, so that the axis of the plant may be either parallel or perpendicular to the axis of rotation (see fig. 17). The spindle *k* turns at one end in a hole in a piece of brass plate at the upper end of the wooden pillar or support *s'*. The other point of support of the spindle is supplied by the brass friction-roller *fr*, which turns in a simple slot in the wooden support *s*, the spindle being grooved at *g* to fit the wheel. The two supports *s* and *s'* are fixed, 25·5 centim. apart, in the wooden board *bb*, 40 centims. long. The board *bb* projects beyond the support *s* to give room for a heavy weight *wt*, which may be used to counterbalance the weight of the plant if required. The driving-force is supplied by a common American watch-action clock *c*, on one of whose smaller wheel-arbors a grooved pulley *p* is fixed. The pulley on the clock being then con-

* Sachs, *loc. cit.* p. 220.

nected with either of the grooved pulleys *W* or *w*, by means of a driving-belt of silk; the spindle of the klinostat can be kept in rotation, either at the rate of one revolution in 20 minutes, or of one revolution in half an hour.

Fig. 14.

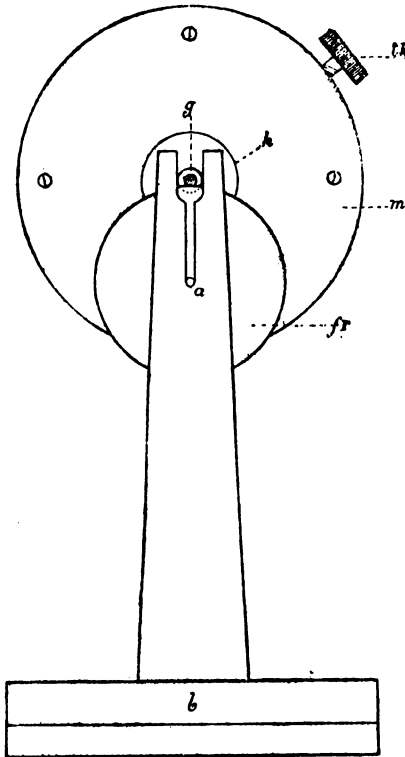

Fig. 14.—Elevation of the support, *s*, &c., in a plane at right angles to that of fig. 13, showing the mode of bearing on the friction-wheel. The spindle with its groove, *g*, is seen in section. Lettering as in fig. 13, with the exception of *h*, which is the edge of the hole in *m*, and within which is seen the disk (*d* in fig. 16) which serves to clamp the spindle in any eccentric position desired.

When a plant growing in the box is fixed on the klinostat, it hardly ever happens that the centre of gravity of the weight coincides with the axis of rotation, so that the clock has to work unequally in different parts of the rotation; and if this inequality in the distribution of the weight is at all large, the clock stops altogether. But the klinostat devised by my brother has an arrangement by which the position of the weight can be altered until its centre of gravity coincides with the axis of rotation.

Fig. 15.

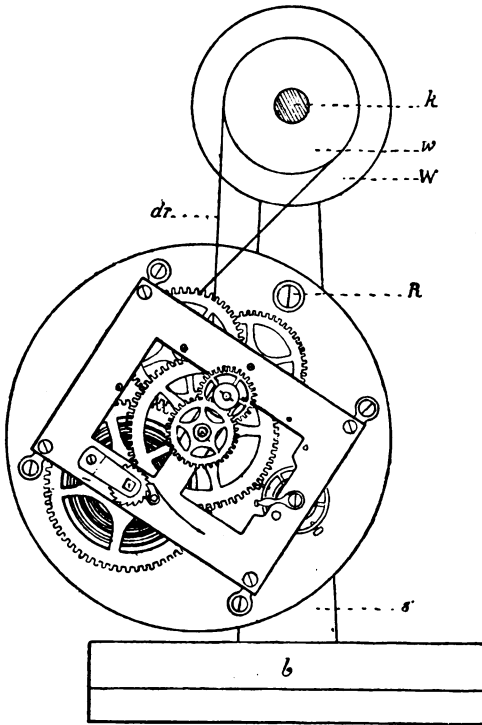

Fig. 15.—Elevation of the support, *s'*, &c. in the plane at right angles to fig. 13, to show the pulleys (*W*, *w*), the clock, and driving-cord. Lettering as in fig. 13.

This arrangement is shown in section in fig. 16. The end of the spindle *k* terminates in a screw *sc*, which passes through the boss *c* and the disk-shaped plate *d* to which *d* is united. As long as the end of the spindle does not press against the brass plate *n*, the disk (carrying with it the spindle) can slide about in any direction parallel to *n* in a cylindrical cavity *sp* sunk in the wooden plate *pl*, of which the floor is formed by a brass plate *n*, and the roof by the plate *m*. The latter plate is firmly attached at its circumference to the wooden disk *pl*, and is pierced in the centre by the hole *h h*. The edges of this hole (*h h*) will thus limit the amount of sliding

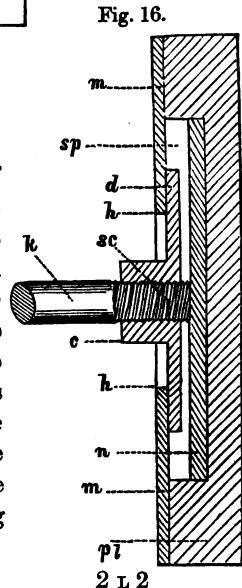

Fig. 16.

of the disk *d* in the space *sp*; and 4 centim. is in practice found to be sufficient for the diameter of *hh*. If now the screw *sc* is made to project through the disk and press against *n*, the disk will be forced against the fixed plate *m*; and by this means the spindle can be secured in an eccentric position; and thus the centre of gravity of the box and plant can be brought into the axis of rotation. This is practically managed in a simple manner. The screw is loosened just enough to allow the disk *d* to be moved by the application of a little force, and yet to support the weight of the box without allowing any slipping to occur. The plant is allowed to assume its natural position, which will be with the heaviest side downwards; the box is then lifted by a hand placed under it, so that the groove *g* no longer touches the friction-roller, and then the upper surface of the boss *c* (fig. 16) is struck gently with a hammer in a vertical direction. This displaces the disk *d* slightly in the right direction; the spindle is then replaced on the wheel, and its state of balance is again tested by giving it a slight rotation with the hand; if it still has a tendency to come to rest in a particular position, the vertical blows with the hammer must be repeated until, when the spindle is made to rotate, it has no marked tendency to come to rest in one position more than another.

A few small points connected with the practical working of the instrument may be mentioned. The clock is fixed to a wooden disk, and this is fixed to the support *s'* by a screw *R* passing through the disk at a point close to its circumference (see fig. 15). Thus the clock can rotate in a vertical plane, and can be fixed in any desired position by means of the screw. It is by this device that the driving-belt of silk passing round *p* and *w* or *W* can be rendered tighter or slacker with great ease; and a little experience soon shows the observer the necessary degree of tension. If the spindle has been removed from its bearings, it is useful to

Fig. 17.

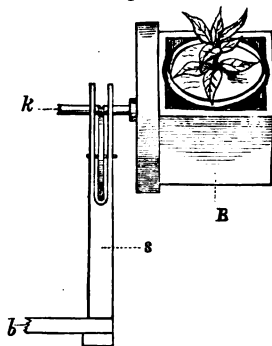

Fig. 17.—Elevation of part of the klinostat in the same plane as fig. 13, showing the arrangement by which a plant can be fixed so that its axis is perpendicular to the axis of rotation instead of parallel as in fig. 13. B, box with flower-pot and plant; *k*, spindle; *b*, portion of board on which instrument stands; *s*, the support.

know that before it is replaced and the driving-silk readjusted the clock should always be stopped, which may be done by inserting a heavy bit of wire into the balance-wheel, the other end of the wire resting on the board *bb*. If this is not done, two accidents may occur, either the silk may get entangled in the teeth of the wheels, or the clock may be forcibly stopped by touching one of the wheels in such a way that escapement becomes fixed; and this never happens when the balance-wheel is stopped as above described.

With this form of klinostat I have easily been able to keep a box of earth and a plant weighing 1000 grams in constant rotation with the certainty that it will not stop. By gearing a stronger clock to the driving-wheels *W* or *w*, a very much heavier weight could be easily driven.

On a Proliferous Condition of *Verbascum nigrum*, L.
By the Rev. GEORGE HENSLow, M.A., F.L.S., F.G.S.

[Read November 18, 1880.]

(PLATES XVI., XVII.)

THE specimen to be described * was received from Mr. Marshall of Ely, and agrees very closely in its malformations with a monstrous condition of *Lysimachia Ephemerum*, L., described by Baillon (*Adansonia*, t. iii. p. 310, pl. iv.). As in the latter, there are differences between the malformed leaves on the lower and upper parts, respectively, of the inflorescence. Thus the terminal portion is much more diffuse than the lower part, while the central stem bears numerous tufts of undeveloped and malformed flowers, amongst which appear the elongated proliferous shoots proceeding from the centres of flowers and occupying the position of the axile placentas.

On the lower part of the stem there were very similar tufts of buds; but the flowers were often larger and mostly of a different character, as will be seen by comparing Plates XVI. and XVII., and as will be explained below.

* Leaving town just as the specimen arrived, and consequently being unable to examine it myself, I am indebted to Mrs. R. C. Barnard for the very careful examination as well as for the illustrations of the uppermost portion of the inflorescence and of the flowers borne by it. The lower part I placed in spirits, and examined on my return.

Amongst the flowers borne by the uppermost part of the inflorescence there were the following variations:—

Flowers with the corolla yellow, stamens abortive, with small oblong anthers and centre axis prolonged (Pl. XVI. fig. 2).

Flowers with the corolla virescent, stamens abortive, with reniform apparently one-celled anthers, and axis prolonged and bearing a tuft of linear leaves (Pl. XVII. figs. 1 and 4).

Both of the above kinds occurred on the higher regions of the upper part of the stem.

On a lower part of the terminal portion were flowers with very small hairy petals, the pistils terminating above with two linear processes, and with the ovules visible within the ovary (Pl. XVII. fig. 2).

At a still lower position were flowers with abortive stamens, while the central axis bore buds below the malformed pistil, now elevated above them (Pl. XVII. fig. 3).

The sterility of the anthers is a phenomenon which likewise, but not always, occurred in species of *Anagallis arvensis*, L., described by Dr. Marchand*, the flowers of which were virescent and proliferous; but the stamens were never free from the petals or foliar organs which represented them.

The ovary also of this plant exhibited somewhat similar differences in degrees of proliferation, as may be seen by studying the Plate together with pp. 164, 165 (*l. c.*).

The chief peculiarity of the flowers on the lower part of the inflorescence consisted in the much enlarged ovaries, which were composed of two carpellary leaves *adherent* down the median lines to a vegetative axis occupying the place of the axile placenta. In many the ovaries were completely closed, with a short pointed style above (Pl. XVII. fig. 7). Others had opened near the summit on one side, whence a tuft of minute leaves protruded (Pl. XVII. fig. 8). In others the carpellary leaves had opened on both sides, or rather there was an absence of cohesion over the summit, so that the leafy axis thrust out its two pendulous leafy tufts, one on each side (Pl. XVII. fig. 9). In other instances the two carpels assumed the form of narrow leaves with widening

* 'Adansonia,' iv. p. 150. See also a paper on a somewhat similar monstrosity of *Linaria Elatine*, Desf., by the same author, Bull. de la Soc. Bot. de la Fr. 1879, p. 107. The reader may also consult Dr. C. Cramer, 'Bildungsabweichungen bei einigen wichtigeren Pflanzenfamilien,' &c., Heft 1, tabb. ix., x., xii.

bases, while between them was an axis covered with ball-shaped hairy flower-buds terminated above by a minute tuft of leaves (Pl. XVII. figs. 10, 11, & 12).

Of these kinds of flowers examined, there were some in which the stamens were of the form represented in Pl. XVII. fig. 11. In others there was no trace of them at all.

The sepals in all cases were free and linear in form. The corolla was gamopetalous, as in the normal state, though varying in size, being usually smaller in the upper part of the inflorescence. Hence they were unlike those of the *Lysimachia* described by Baillon, in which neither the sepals nor petals were coherent. The present monstrosity, however, agrees with that plant in the fact that, in both, the stamens, when present, are abortive and *free from the corolla*, being inserted on the axis below the malformed carpels. The anthers of the *Verbascum* were of two sorts, some reniform, others minute and oblong (compare Pl. XVI. fig. 1 and Pl. XVII. fig. 3); but in all cases apparently quite abortive.

With reference to the difference between the upper and lower parts, Baillon says that he does not know why the proliferous axes are more prolonged into shrubby processes on the higher part than in the lower. There seems, however, a very simple cause, namely the tendency of the vegetative extremities of plants to take the lead before the laterals; consequently the axis of the flowers in the upper part have shot out while those lower down have been delayed in doing so, till the arrested stage became fixed and the buds could not develop at all, as shown in the flowers on Plate XVI.

Another difference between the present plant and Baillon's *Lysimachia* consists in the fact that in the latter the placenta is normally free and central, so that the proliferous axis arises, as it were, from a free tube; but in the *Verbascum* the axis is adherent to the two carpellary leaves, this adhesion causing two deep longitudinal furrows to be seen on the exterior surface and on opposite sides of the ovary.

EXPLANATION OF THE PLATES.

PLATE XVI.

- Fig. 1. Terminal portion of a monstrous state of *Verbascum nigrum*, L., bearing proliferous shoots which occupy the position of the axile placenta.
 2. Malformed flower from the uppermost part of the inflorescence.

PLATE XVII.

- Fig. 1. Monstrous *Verbascum nigrum*, L., malformed flower from the superior part of the inflorescence.
 Figs. 2 and 5. Malformed flowers from a lower position on this portion of the plant.
 Fig. 3. An open malformed carpel, from a flower similar to that of fig. 2.
 4. An abortive stamen, from a flower represented in fig. 1.
 6. The lower portion of the inflorescence of *Verbascum nigrum*, L. The axes in the flowers borne by this part are arrested or still enclosed within the enlarged ovaries.
 7. Flower with ovary entirely closed.
 8. Flower with ovary open at one side, allowing a tuft of leaves to protrude.
 9. Flower with ovary open above, allowing two opposite tufts of leaves to protrude.
 10. Flower in which the carpels are entirely free. The axis is covered with ball-like flower-buds, and is terminated above by a tuft of minute leaves.
 11. A carpellary leaf of flower represented by fig. 10.
 12. A flower-bud from fig. 5, enlarged. The dissections are mostly somewhat enlarged.

Remarks on the Indian Coffee-Leaf Disease. By Mr. WILLIAM BIDIE, in a Letter addressed to, and communicated by, JOHN CAMERON, F.L.S., Superintendent of the Botanic Gardens, Bangalore.

[Read February 3, 1881.]

Bangalore, Dec. 29, 1880.

.... The Coorg country is situated in the Western Ghats, between N. lat. $11^{\circ} 55'$ and $12^{\circ} 50'$ and E. long. $75^{\circ} 25'$ and $76^{\circ} 14'$. The European enterprise in coffee has wholly developed in Coorg within the last twenty-five years; and no disease was observed till four or five years ago. Mr. Bidie seems to think (and this is



VERBASCUM NIGRUM, L.
A. Barnard del. J. N. Fitch lithet imp.



G.Henslow del.

PROLIFEROUS VERBASCUM NIGRUM, L.

Fitch lith et imp

a general opinion) that the disease was imported from Ceylon or Chickmoogloor, the latter being a Coffee-district of Mysore, which is only about sixty miles distant from the plantations of Coorg.

J. CAMERON.

“ Benlmond Estate, Amutty, S. Coorg,
23 December, 1880.

“ So much has been written about leaf-disease by scientific men who have made it a special study, that any remarks of mine will, I fear, be of little use, and can hardly be original, as the subject has occupied so much attention in Ceylon that it may be fairly said to be exhausted. Some two years ago the Government sent Mr. Harman to the coffee-districts to investigate and, if possible, suggest a remedy for the coffee-leaf disease. The time at his command was far too short to enable him to do more than merely glance at the various places he visited; so that the only practical result was a lot of money spent, and we poor planters told to adopt a better system of cultivation and go in for experiments in culture and manuring. This is easily said; but when labour is such a difficult problem to solve, we have to run as much as possible in the beaten track, so that no money may be wasted; and when superintendents have to give an account of every ‘pie’ they spend to absent proprietors, they do not care to attempt any new mode. Resident proprietors again, as a rule, say they cannot afford to spend money on experiments, it being all they can do to get sufficient coolies to cultivate in the usual routine.

“ Badly cultivated fields, or those impoverished by want of cultivation and manure, are particularly liable to disease; and in these fields the disease first shows itself on a tree of coarse growth whose branches have an upward turn, and foliage of a paler colour; these are well known in Coorg as ‘chicks,’ a name given to them on the supposition that they were originally introduced to Coorg from Chickmoogloor in Nuggur. Whether this supposition is correct, I cannot say; but I know that planters in that district are very willing to pay a long price for Coorg seed, which is a proof that the Mysore trees are inferior to Coorg. Could we thoroughly weed out these chick-trees, we would have less cause to dread any of the ailments coffee suffers from.

“ I see leaf-disease attack plants at all stages of their growth, when in the nursery with their first pair of leaves, and subse-

quently at all ages in the field. Plants taken from a swampy nursery and planted in rich and dry soil often suffer, probably having the disease ere they were transplanted. If plants are put out in a weedy estate and are allowed to be smothered in weeds, and the soil round the plant caked, these suffer fearfully, often being destroyed, or else so weakened that the following dry season settles them.

“The worst field I ever saw was one three years old, and on which there was no crop, the soil very poor and the subsoil rather gravelly, and what we call hungry, as no manures seem to have a lasting effect. This season I first noticed it on our impoverished field of old coffee which was overrun with Harriale, and on which there was little shade. From this field it spread to all unshaded parts; but under good shade it has done very little damage. This was in August last, and during a break we then had. Since then I noticed one very bad field, unshaded, and uncultivated as regards the soil, which was simply a sheet of grass. Another estate I noticed had it bad in August; but it was then manured with guano and bones; and now it has got quite over the disease, and is throwing out no end of young wood.

“When the leaf is fairly covered with the rust, I have noticed a small red insect feeding on it, or as I suppose to be feeding, as it moves every now and again, covering the hairs on its body with the spores, and, as I think, feeding by absorbing their contents. If you can suggest any mode by which I could convey a few leaves to you, I would send them, so that you might see this insect for yourself. I have only noticed these insects before the leaves get covered with the white web, which all get about the time they are detached from the trees, and which is, I suppose, the disease in an advanced stage. As a remedy, I can suggest nothing; but deep cultivation, manure, and shade of good trees will help the trees to get over the disease; and by gradually weeding out the ‘chicks,’ I hope that we in Coorg may not have to cry out as the Ceylon planters have. I may here state that a field planted with plants raised from Ceylon seeds was badly affected, and yet the surrounding fields of Coorg trees have as yet shown no symptoms of it. This I noticed early in September. The fields were then being pitted—*i. e.* between every four trees a large pit is opened, 3 feet long by $1\frac{1}{2}$ foot wide and deep; these we leave open till weeds, fallen leaves, prunings, and manure fills them up again, and they are known as renovating-pits.

Probably this pitting may have had something to do with the safety of the Coorg trees; but it seems strange the Ceylon plants should get it, as soil, exposure, and cultivation were the same in every way.

“W.M. BIDIE.”

The Coffee-Disease in South America.

By M. C. COOKE, M.A., A.L.S.

[Read February 3, 1881.]

(PLATE XVIII.)

THE coffee-plant seems destined to become the victim of destructive parasites in all countries wherever it is extensively cultivated. The Ceylon coffee-disease has long been known; and its fungus, the *Hemileia vastatrix*, has had considerable attention, and been made the subject of successive investigations. Probably we are now in a fair way of knowing all that can be known of its life-history; and this is the only safe basis on which to hope for a radical cure.

The same pest is known in the coffee-plantations of Mysore, accompanied by another form of disease known as the Koleroga, or black rot, also of fungoid origin, and apparently unknown in Ceylon. It was this disease which I examined and reported upon to the Government of India in 1876 under the name of *Pellicularia Koleroga**. The fungus is entirely superficial, spreading over the leaves in a compact filamentous film, somewhat like the mycelium of an *Erysiphe* in external appearance, but quite different in its internal structure when seen under the microscope. The felted threads bear their own proper spores, reminding one somewhat of the genus *Zygodemus*; but the film is so superficial that when it is moistened it can be removed in flakes from the surface of the leaves without resistance. With the majority, probably all, of the species of *Erysiphe* and its allies the mycelium cannot be thus removed, on account of the processes which enter the substance of the leaves through the stomata. Until recently it was not known that this disease had made its appearance on the coffee-plant outside of Southern India.

The existence of destructive parasites on coffee in South America was intimated as long ago as 1876, the same year in which the

* ‘Grevillea,’ iv. p. 116.

Mysore fungus was investigated. The first communication was from Venezuela*, which stated that the coffee-disease there known was called "*Candelillo*" or "*Mancha de hierro*" (iron stain); and specimens of the leaves were sent for examination with the following note, drawn up by Señor Saenz, Professor of Botany in the University of Bogotá. The disease, he says, "consists of circular or elliptical blotches of an ochreish-yellow colour, in which are to be observed hard knots in the centre, round which are formed concentric bands. The salient knots are to be easily distinguished on each side of the leaf; but on the one side only are to be found small fungi of a yellow colour (orange), formed of a very delicate pedicle crowned by a small sheaf of fibres, in which are an abundance of oval corpuscles of a darker colour, approaching to green, and of .003 millim. in diameter."

The specimens which accompanied this note were submitted to the Rev. M. J. Berkeley, who reported that the spots were occupied by a minute fungus which he called *Depazea maculosa*, Berk., having fusiform spores .0008 inch long (or .02 millim.) with about seven nuclei.

It may be remarked here that the old genus *Depazea* of Fries was characterized chiefly by the presence of small perithecia seated on discoloured spots, the structure of the perithecia and their contents not being taken into account. Hence some of the species of *Depazea* had perithecia which contained only stylospores, others' asci with sporidia. When microscopic fungi had to be revised, as a consequence of improvement in the microscope, the genus *Depazea* was divided into two parts: those containing stylospores in the perithecia were denominated *Septoria*, and those in which the perithecia contained asci were relegated to *Sphaerella*, and the old name of *Depazea* became practically obsolete. The species above noted as *Depazea maculosa* would therefore now be denominated *Septoria maculosa*. Experience has demonstrated that in some cases the *Septoria* is only an imperfect condition of an ascigerous *Sphaerella*, which makes its appearance on the same or upon contiguous spots on the same leaves. The relevancy of these observations will be apparent hereafter.

Subsequently, further specimens were sent to Kew Gardens† from Dr. Ernst of Caracas, which demonstrated that the names of "*Candelillo*" and "*Mancha de hierro*" were not applicable to

* Kew Gardens Report for 1876, p. 21.

† Kew Gardens Report for 1877, p. 28.

the same disease, and also that destruction was caused, and some of the leaf-spots produced, by an insect named *Cemiosstoma coffeellum*. At this time (1877) it became manifest that three parasites had attacked the coffee-plant in South America, namely, the *Cemiosstoma*, the "Candelillo," and the "Mancha de hierro."

In a memoir published by Dr. Ernst in Spanish he described the Candelillo somewhat fully, and applied to the fungus which produced it the name of *Erysiphe scandens*. The felted mycelium which overspread the leaves seemed to him to be the mycelium of an *Erysiphe*; and he believed that he discovered also some cysts similar to the pycnidia of *Erysiphe*. It was never assumed that the conceptacles of an *Erysiphe* had been found; but the name was applied to the imperfect mycelium on account of its supposed resemblance to that of some *Erysiphe*.

During the past year I received some coffee-leaves from Dr. Ernst bearing the "Candelillo," or supposed *Erysiphe*; and these leaves I examined carefully without finding pycnidia, but with somewhat of surprise that it was the identical "black rot" or "*Koleroga*" of Mysore, and that the fungus was none other than that which I had described as *Pellicularia Koleroga*. This fact was clearly demonstrated by finding the globose echinulate spores, that the "Candelillo" of Venezuela is the "*Koleroga*" of Mysore, and the *Erysiphe scandens*, Ernst, a synonym of *Pellicularia Koleroga*, Cooke.

The "Mancha de hierro" differs most distinctly from the "Candelillo" in forming discoloured orbicular spots on the leaves; and it is therefore to *that* which reference is made in the note by Professor Saenz, and also in a further communication from the Commissioner of Agriculture at Bogotá to Dr. Ernst, published in July 1880*. The Commissioner writes:—"At first there appear on the leaves small spots of a light greenish colour, which in two or three days turn brownish, and then appears on each of them a fungus divided in three or more greenish-yellow branches. This fungus is said to be phosphorescent at night; and in places where it is very common a phosphoric smell is noted. After some days the diseased leaves fall off, the fruits, which also are attacked by the parasite, follow very soon, and the trees are left quite bare. They form, however, new leaves after some months; but these are again attacked by the fungus. The disease is reported to be more frequent in damp places than in dry ones, its ravages

* 'Nature,' July 29th, 1880.

being greatest in plantations where the trees are planted rather close. The fungus has also attacked the shade-trees, especially the Guamos (*Inga* sp.).”

Other communications which I have received, accompanied by specimens, demonstrate that the same disease is spreading widely through the coffee-districts of Costa Rica and other parts of Central America, New Granada, and Venezuela, and causing considerable alarm.

The leaves and unripe berries are marked by distinct pale spots, nearly orbicular, with a regular well-defined outline, and in the leaves quite perfect on both surfaces, from about a quarter to nearly half an inch in diameter, from two or three to five or six or more spots on the same leaf. These spots are often quite smooth, uniform in colour, and without any external evidence of the presence of a fungus. In these instances they seem as if they might as well have originated with an insect as with a fungus. Others of these pale spots are occupied by a few minute dark-brown perithecia, so minute as not to exceed the puncture of a pin. These perithecia, seated on pale orbicular spots, constitute the *Depazea maculosa* of Berkeley; but as I have found in all of them which I have examined perfect asci and sporidia, they were named and described as *Sphærella coffeicola**. At that time I had not seen the specimens which Berkeley determined as *Depazea maculosa*; but as he found no asci, and characterized it as a *Septoria*, the *Sphærella* may be treated as a distinct fungus, although, in my own opinion, it is only the perfect or ascigerous condition of the same parasite.

The question would arise at once as to the general character of *Septoria* and also of *Sphærella*, and whether they are likely to be productive of such a disease as that of the South-American coffee. There are no very distinct records of species destructive in this manner and to this extent; but there is, on the other hand, no reason why either *Septoria* or *Sphærella* may not be destructive. This may be affirmed more strongly of *Sphærella*; since within the past two years *Sphærella Taxi* has undoubtedly proved very destructive to yew-trees in Cornwall; and as for *Septoria*, some species have, to a limited extent, appeared as a destructive pest. Under any circumstances, if this really proves to be the cause and not a consequence of the coffee-disease in South America, it has the merit of being more truly devastating than any of its pre-

* ‘Grevillea,’ ix. p. 10 (1880).

decessors. It must be remembered that the perithecia are never numerous on the spots, and that at least half the discoloured spots are wholly without them. The spots are present, but there are no external evidences of fungi; and in some of these naked spots which were examined internally I failed to trace any mycelium.

There is, however, still another feature in connexion with these discoloured spots, that upon some of them, sometimes on the upper and sometimes on the under surface, another and very different kind of fungus flourishes. A pocket-lens will be sufficient to detect on some of the spots small, erect, slender, yellow threads with a globose head, five or six of them upon one discoloured spot. Sometimes they will be found on the same spots as the perithecia of the *Sphærella*, and sometimes on spots in which no perithecia can be detected. This *Stilbum*, which has been named *Stilbum flavidum**, has, like all other species, a compound stem formed of a bundle of slender filaments, parallel to each other, fused into a common stem, terminated by a globose head, composed of the free ends of the component filaments, subdivided and terminated by minute subglobose spores, scarce .0015 millim. in diameter. This corresponds very closely with the description of the parasite as described by Professor Saenz, who indicated "the circular or elliptical blotches of an ochreish-yellow colour" and the "hard knots in the centre," which are the perithecia of the *Sphærella*, and the "small fungi of a yellow colour, formed of a very delicate pedicle crowned by a small sheaf of fibres, in which are an abundance of oval corpuscles." The only difference appears to be that his measurement of the corpuscles is about double that of mine, his being .003 millim., and my own .0015 millim. for the spores of the *Stilbum*, a discrepancy not so very extraordinary when the minute size of the bodies is taken into account.

The Commissioner of Agriculture at Bogotá also undoubtedly saw the same fungus, although his description is less exact and accurate. Whether there is any foundation for the belief that this little fungus is phosphorescent or emits an odour of phosphorus, cannot be affirmed, as he evidently mentions it with some reservation.

I have now demonstrated that the coloured spots may be without any visible fungus upon them, and exhibit no trace of

* 'Grevillea,' ix. p. 11 (1880).

mycelium in the tissues, or they may nourish a *Septoria*, as seen by the Rev. M. J. Berkeley, or a *Sphærella*, as found by myself; or, finally, a species of *Stilbum*, as seen by myself and by Professor Saenz. Further, the *Stilbum* may occur on the same spot as the perithecia of the *Sphærella*, or both perithecia and *Stilbum* (the one without the other) may be found occupying different spots. All these points are worthy of consideration in searching for the source of the disease.

I cannot forbear noticing incidentally that *Sphærella isariphora*, Desm., a small species of *Sphærella* common on the leaves of some species of *Stellaria*, owes its name to the fact that it is sometimes found associated with a minute species of *Isaria*, a mould closely allied to *Stilbum*, although the *Sphærella* is often found without the *Isaria*.

On unripe coffee-berries from Costa Rica, as well as from Venezuela, the same orbicular spots occur, usually one spot only on each berry; and on some of these spots I have seen the *Stilbum*, but hitherto have not observed the *Sphærella*.

These observations are communicated to the Society as a summary of all that at present has been determined respecting the coffee-disease of South America. I venture to think that the disease seems to be a complicated one; and for the present I am not prepared to affirm that either the *Septoria*, or the *Sphærella*, or the *Stilbum*, or all together, is the cause of the disease. At the same time I cannot but think it possible that none of the three forms of fungus are autonomous, and that all may be related to each other as forms or conditions of the same fungus, of which the *Sphærella* is the highest and most perfect manifestation.

Since the foregoing was written, I have been permitted by the Rev. M. J. Berkeley to examine some diseased coffee-leaves* from the island of Jamaica. The same discoloured spots are present, although smaller in size, and little dark specks or points (visible under a lens) on these at once suggested a *Septoria* or *Sphærella*; but microscopical examination showed that the dark points were not perithecia, but tufts of short-jointed olive threads,

* [The leaves in question were sent by Mr. Morris, Government Botanist at Jamaica, accompanied by a sketch of the *Cercospora*; but neither Mr. Morris nor Mr. Berkeley could find spores; and Dr. Cooke found them only after long and patient examination. Mr. Berkeley thinks that the *Cercospora* is possibly the same with *Cladosporium stenospora*, B. & Curtis.—M. J. B.]

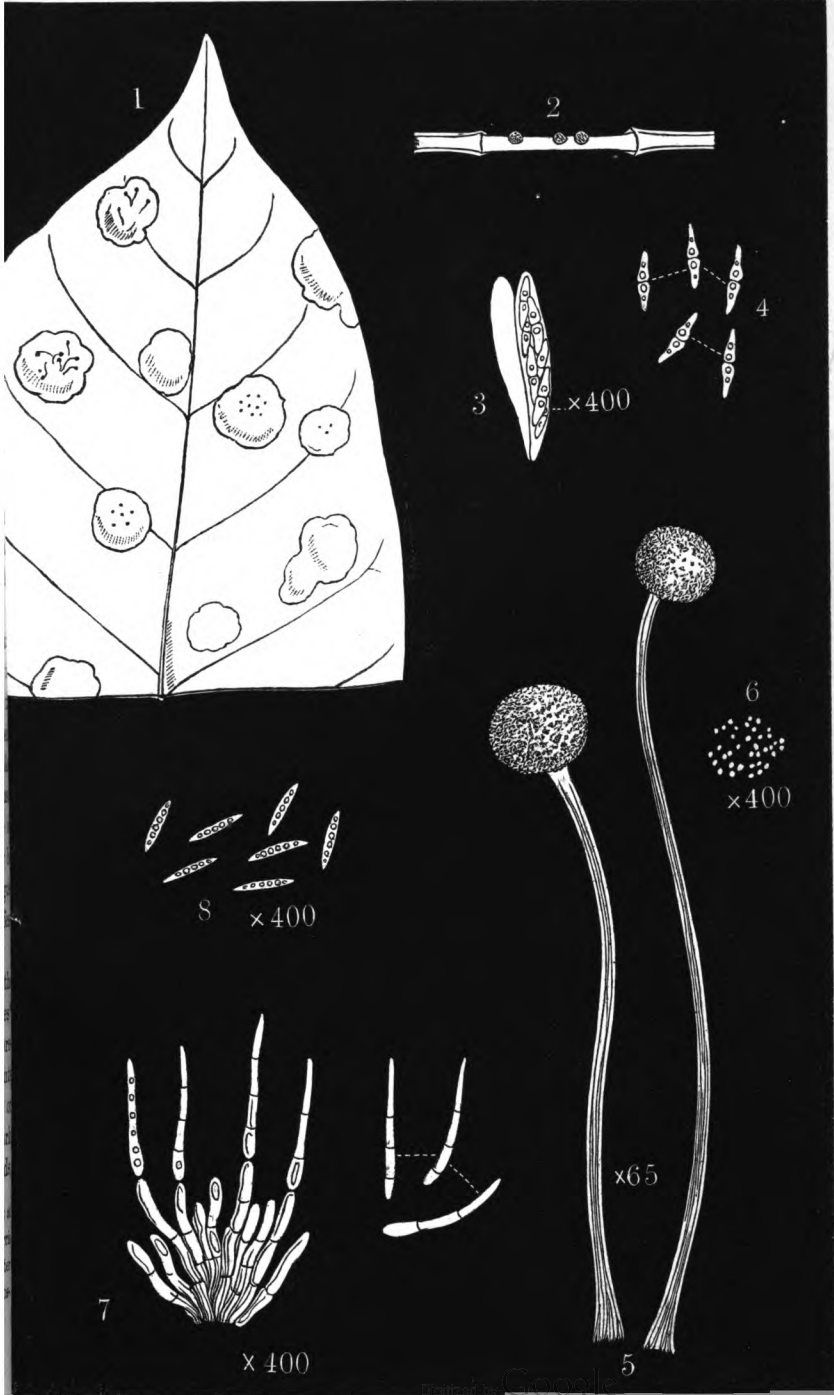

with hyaline bacillary spores growing at the apex. This apparently new species of *Cercospora* has been called *Cercospora coffeicola*, Berk. & Cooke. Nearly all the species of this genus occur on living or fading leaves, and many of them grow on discoloured spots. The septate threads generally grow in tufts; and the habit is somewhat that of a small *Cladosporium*, to which the genus is closely allied. It is noteworthy that we have here, in another locality, an entirely different species, genus, and order of Fungi growing upon almost identical pallid spots on coffee-leaves. It renders still more difficult an answer to the question, "What is the cause of this form of coffee-disease?"

DESCRIPTION OF PLATE XVIII.

- Fig. 1. Portion of coffee-leaf with the diseased spots, nat. size.
 2. Section of diseased spot, showing perithecia.
 3. Asci and sporidia of *Sphaerella coffeicola*, $\times 400$ diameters.
 4. Sporidia of the same, $\times 400$ diameters.
 5. Two individuals of *Stilbum flavidum*, $\times 65$ diameters.
 6. Spores of the same, $\times 400$ diameters.
 7. Tuft of hyphæ and spores of *Cercospora coffeicola*, $\times 400$ diameters.
 8. Supposed spores of *Depazea maculosa*, $\times 400$ diameters. Drawn to scale from the description only.

On the Occurrence of Stipules in *Ilex Aquifolium*.

By A. CRAIG CHRISTIE, F.L.S.

[Read February 3, 1881.]

IN the 'Flora of British India,' i. p. 598, Sir J. D. Hooker observes that the character attributed to the Ilicinæ requires considerable alteration. In the revised ordinal character he writes—"Leaves exstipulate, or with minute stipules;" and he gives small stipules to the species *Ilex Godajam*. Dr. Brandis also, in his 'Forest Flora of North-west India,' attributes stipules to two of his species of *Ilex*.

The occurrence of stipules in the order Ilicinæ is not therefore quite novel, though I cannot find that the presence of small stipules in *Ilex Aquifolium* has hitherto been noticed. Indeed, in several of our works on systematic botany, it is expressly stated that the natural order Ilicinæ has "exstipulate

leaves." As this is not the case, I venture to send specimens of *Ilex Aquifolium*, L., for exhibition and the examination of the Fellows of the Linnean Society, which show the presence of small, though very well-marked stipules.

The stipules in question seem to be non-deciduous, though they may, in some instances, be easily removed by *external* influences. My attention was first called to their presence by one of my pupils, Miss J. S. Mitchell; and I have since verified the fact by repeated observation on the living plant.

In passing, I may further call attention to the scarcity of the fruit of the Holly in this part of Scotland, especially the neighbourhood of Edinburgh, where, in the examination of some hundreds of plants during this winter season, I scarcely have met with more than twenty-five holly-berries.

On Right-hand and Left-hand Contortion.

By C. B. CLARKE, M.A., F.L.S.

[Read February 17, 1881.]

FOR many years there has been a dissension between the leading descriptive botanists as to the employment of the term right-hand contortion. Those genera of Myrsinaceæ which M. Alph. DeCandolle, in the 'Prodromus,' diagnoses as having the lobes of the corolla contorted to the right-hand, are described by Mr. Bentham, in the 'Genera Plantarum,' as having the lobes of the corolla contorted to the left-hand. This dissension between authorities still continues unabated: in his 'Phytographie,' published last year, A. DeCandolle devotes more than seven pages to this point; and Prof. A. Gray has reviewed A. DeCandolle at length in 'Silliman's Journal.'

The inconvenience which is thus caused to other botanists when they describe plants is serious. Every body is obliged to learn what Bentham and A. DeCandolle mean by right-hand contortion; but if a lesser writer says "dextrorsum contortis," it is very troublesome to turn about the book, and endeavour to discover by inference whether the writer uses the term "sensu Candolleano" or "sensu Benthamiano." To meet this difficulty, A. De Candolle (in his 'Phytographie,' p. 208) advises authors, whenever they use the term "dextrorsum contortis," to add either

the words "e centro visum" or "externe visum." This is rather cumbrous; but one of the points I hope to make clear in this paper is that it makes no difference whatever whether the describer conceives himself within or without the spire. I hope, therefore, I have already made plain how important it is that botanists, great and small, should employ the term "dextrorsum contortis" in one uniform sense. It is very far from my wish to pretend to decide *in which sense*, while such divergence in usage reigns among our great men. I do hope in the present paper to clear away much that obscures and confuses the subject, and to show what the exact and single point is which is in dispute.

There is no difference of opinion as to which is the right-hand twist; gardeners call it the way of the sun. Both Bentham and A. DeCandolle are agreed that the hands of a clock go round the right-hand way; we deal at whist and put on the railway-break that way. I do not suppose that in the north temperate zone there is any difference of opinion on this. The employment of the word "dextrorsum" to represent this direction of twist is, however, arbitrary: the motion is indeed from left to right if you look at the hour 12 in the clock-face or the sun at noon; but it is from right to left when the clock-hand passes 6 and at the lower (invisible) transit of the sun across the meridian plane. A. De Candolle has remarked this. It only indicates, what requires no mathematics to see, that a twist cannot be completely represented by a linear motion; one twist must be compared with another twist. In elementary works of mathematics the clock-hand way is taken as the positive direction of a twist, the reverse way as the negative. Mathematicians prefer the term "positive" for the clock-hand way, because it is no more right-hand than left-hand; but they often slip into the vulgar universal use of the word "right-hand" to describe such direction of twist. There is no reason why botanists should not retain the Linnæan word right-hand for the clock-hand direction, provided it is understood that this use of the word is entirely arbitrary; if it is maintained that the clock-hand direction is more to the right-hand than to the left-hand, it may become necessary to fall back on the term positive for that direction.

The botanic definition of right-hand contortion is grounded on the words of Linnæus—"Sinistrorsum hoc est, quod respicit sinistrum, si ponas te ipsum in centro constitutum, meridiem adspi-

cere; dextrorsum itaque contrarium." Linnæus was a very fair astronomer; he here places himself in the normal position of an observer in the north temperate zone, and looks south at the midday sun: he says that then the right-hand way round is the way of the sun. Every gardener of that day and of the present reckons the same way. But A. DeCandolle says ('Phytographie,' p. 202) that the words "meridiem adspicere" are entirely useless, and that it makes no difference whether the spectator turns to the north or to the south; and Asa Gray says the same.

At this point we take leave of all questions of convention and definition. This is the crucial point in the dispute; and I maintain Linnæus to be altogether right, and that those who say he is wrong have not understood him. If I turn *north*, the diurnal revolution of the heavens takes place in the direction contrary to the clock-hand.

In fig. 1 a spectator at *a* observes, looking south, the dextrorse contortion depicted: at XII the motion is from left to right, at VI from right to left, and (I might add) at IX from foot to head; but it is all one way round, which we are agreed to call the right-hand way. The spectator advances to *b*, looking still south; the motion is still from left to right at XII, from right to left at VI; it makes

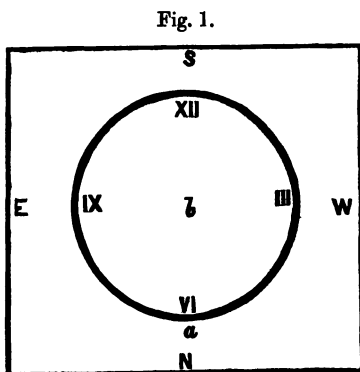

no difference his being within the spire instead of without. If the spectator, however, faces north, whether within or without the spire, the direction of motion at both the points VI and XII is reversed, as described in right and left; because simply the spectator has altered the position of his own right and left hands. An objector may say, I look at the part of the circle nearest me at *a* (*i. e.* at VI), and when I have crossed it and got within to *b*, I turn round and look at the same portion of the circle which is still nearest me, and see the direction of motion at VI reversed. I reply, "Yes; but not because you entered within the circle, but because you turned round and faced north." A. DeCandolle says it makes no difference whether you look

north or south. Linnæus has provided, however, that you are to look south. Similarly, when you have entered the circle, the direction of motion will be reversed if you stand upon your head; not because you entered the circle, but because you stood upon your head. You may stand on your head without entering the circle. Linnæus did not provide against this; it is, however, the exact point that botanists now have to provide against.

I have treated the subject for simplicity in one plane; *i. e.* I have considered the case of a circle instead of a helix: the latter is really included in the former; but without talking of projections, we can see that if the circle is cracked at one point and one end lifted up a very little, so as to transform the circle into a very depressed helix of one turn, all that has been stated about the direction of twist in a circle must apply to the twist in the helix; and it is equally clear that what is true of the depressed helix must be true of a more elongate one.

Fig. 2 is intended to show the application to a contorted corolla, which is represented cut at right angles in two pieces, the upper piece lifted upwards a little. Looking at this upper piece, whether we imagine ourselves within or without, the contortion is dextrorse; but if we were to take up the lower half of the corolla and look at the section, the contortion would appear sinistrorse: this we may see by looking through the back of the page at the section of the upper half. This is the point at issue between A. DeCandolle and Bentham: A. DeCandolle looks down the axis of the flower, Bentham looks up it. In describing a twist there are two points to be settled conventionally: (1) which way round is to be called right-handed; (2) which direction of the axis (round which the twist takes place) is to be reckoned positive. As I understand, there

Fig. 2.



no difference among botanists regarding the first point; the contention is really regarding the second. Bentham takes the axis of vegetative growth as the positive direction; A. DeCandolle takes that direction as negative, which seems less philosophical;

but Linnæus appears to have looked this way at flowers, at least sometimes.

Mr. Bentham has of late years replaced the Linnæan "dextrorsum contortis" by "lobis dextrorsum sese obtegentibus," and sometimes by "lobis dextrorsum contortis et obtegentibus." This is intended to meet the case which occurs occasionally (in Asclepiadææ not rarely), wherein, though the corolla is strongly contorted to the right, the line of overlap of the lobes is nearly vertical or even (near the tip of the corolla) somewhat towards the left. In such a case the contortion is really dextrorse, and the contour of the edges of the lobes not a point of much importance. Mr. Bentham's alteration of the words does not affect the main point at issue: if the edges of the corolla-lobes, as viewed from the base, appear to overlap to the right, then, as viewed from the tip, they will appear to overlap to the left. If we alter at all Linnæus's definition, what we require is some word to show that we regard the bud from its base, not from its tip; that we stand on our feet as we look at the sun at noon, not on our head.

The case of twining-stems is, I need hardly say, similar to that of contortion of corolla-lobes; but it is much less confused, because gardeners, as well as botanists, have generally taken the axis of growth as the positive axis, as Linnæus uniformly did. In fig. 3 a climber is ascending a tree with a right-hand contortion; if, however, we turn the book upside down, the contortion appears left-hand. Also if we look through the page from behind the contortion appears left-hand; this is the same as supposing ourselves inside the tree and turning *also* right-about-face. Lastly, if we turn the page upside down and then look through it from behind, the contortion appears right-hand. There are, in short, *two* arbitrary conventions; therefore *four* cases.

If in fig. 3 we suppose a twiner to grow *down* a stem so that the direction of all the arrows is reversed, the direction of the twist is reversed. A distinguished botanist twisted a piece of string round a cedar pencil and pointed out to me, with some triumph, that the direction of the twist appeared the same from either end of the pencil. This of course merely amounts to saying that if you

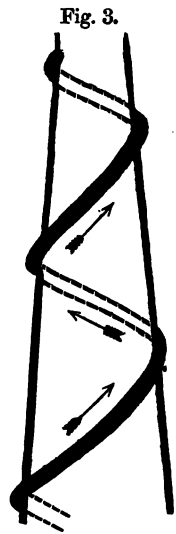

reverse the direction of rotation and also reverse the direction in which you look along the axis, the direction of twist is not altered.

I suppose myself to have shown :—

(1) That Linnæus's original definition of right-hand twist is exceedingly good, and contains no surplusage.

(2) That in observing contortion it makes no difference whether you imagine yourself within or without the spire, so long as you do not turn yourself round or stand upon your head.

(3) That all botanists are agreed which is a right-hand twist, viz. the clock-hand way.

(4) That the differences in describing the contortion of a corolla-bud arise from some botanists regarding it from the base, others from the tip.

(5) That it is a pure matter of convention whether we reckon the axis of growth of the flower as positive or negative ; but that this is the only point of convention remaining to be settled.

(6) That it does not much matter which way it is settled ; but that it is of the greatest importance to all botanic describers that it should be settled, definitely and finally, one way *or* the other.

On the Conifers of Japan.

By MAXWELL T. MASTERS, M.D., F.R.S. & L.S.

[Read December 2, 1880.]

(PLATES XIX. & XX.)

THE object of the following paper is to give a complete list of the Conifers of Japan known up to the present time, together with incidental remarks on their structure, affinities, synonymy, and geographical distribution. The list was originally drawn up as a guide to the identification of the numerous and well-preserved specimens of Conifers brought from Yesso and various parts of Japan by Mr. Maries, and which were kindly placed in my hands for determination by Messrs. Veitch. The study of these specimens necessitated reference to other Japanese collections, to the Coniferous plants of North-east Asia generally, and, to some extent, to those of the coast of North-west America. In carrying on these investigations, I have had the advantage of studying the collections at Kew (both living and dried), those at the British Museum, those in the museum of Messrs. Veitch (including the original

types brought home by the late Mr. John Gould Veitch), as well as living specimens in their nurseries and in various other horticultural establishments. The library at Kew has also been of great service to me in referring to the numerous publications relating to the subject in hand.

In drawing up the list, I have followed the arrangement of the genera adopted by Mr. Bentham in *Benth. et Hook. 'Genera Plantarum,'* vol. iii. p. 420 (1880). As to the species, I have followed the publications of Murray, Parlature, Engelmann, and other authors; but I have personally examined all those native to Japan, except in the case of some genera (as *Juniperus* and *Podocarpus*), wherein, from lack of material, I have been constrained to depend chiefly on the labours of others.

The tabular list at pp. 483–485 comprises, in the first column, an enumeration of all the species known to inhabit the Japanese islands, inclusive of Yesso. The succeeding columns are intended to show the distribution of the Japanese Conifers in adjacent countries, as well as to indicate the existence and geographical distribution of nearly allied or “representative species.” The columns relating to the mainland of North-east Asia and to the islands of Sachalin and Yesso contain, it is believed, a complete enumeration of the species so far as they are known. In the remaining columns only such species are entered as may be considered representative, very nearly related, or analogous to the Japanese species, or which have some special interest to warrant their introduction. Separate lists are given for the Kurile Islands and for those of Sachalin and Yesso, for the purpose of showing the relation of the Coniferous flora of Japan proper to that of North-east Asia and that of North-west America, between which countries and Japan these islands are situated. These lists must, of course, be looked on as approximately correct only; for, doubtless, much yet remains to be learnt of the floras of these regions.

The authorities specially referred to for indications as to the geographical distribution of particular species have been:—Parlature in DeCandolle's 'Prodrômus,' xvi. sect. 2, 1868; DeCandolle's 'Géographie Botanique;' Tchihatchef's French translation of Grisebach's 'Vegetation der Erde,' enriched as it is by notes of the translator and of M. Fournier; Beinling's memoir 'Ueber die Geographische Verbreitung der Coniferen;' Hildebrand's paper entitled "Die Verbreitung der Coniferen in der Jetztzeit und in den früheren geologischen Perioden," and other general works.

For the Conifers of the Arctic regions, of Siberia, of the north-east coasts of Asia, and the adjacent islands I have consulted Ledebour's 'Flora Rossica,' and Hooker on the Distribution of Arctic plants, Trans. Linn. Soc. vol. xxiii. (paper read June 21, 1860). For species found in Manchuria and Amuria I have turned to Trautvetter and Meyer's enumeration in Middendorff's 'Reise,' to Maximowicz's 'Primit. Flor. Amur.' (1859) p. 260, to Regel's 'Flora Ussuriensis' (1862), to Schmidt's 'Reise im Amurland und auf Sachalin.' For China I have depended on the publications of Bunge (Enum. Plant. Chin.), Ruprecht (Sertum Tianschanicum), Fortune, &c. For the Conifers of Russian America I have trusted to the publications of Ledebour, to Bongard's 'Observations sur la végétation de l'île de Sitka,' Seemann's 'Botany of the Herald,' Rothrock's 'Sketch of the Flora of Alaska.' For North-western America I have referred especially to Hooker's 'Flora Boreali-Americana' and Engelmann's "Monograph of Conifers" in the 'Botany of California'*

In the detailed enumeration of the species (p. 485 *et seqq.*), the authorities for the names adopted and for the synonyms are cited in full, as also in cases where an illustration is given; but those publications in which no original description is given, but merely a transcript from some other source, are not expressly mentioned, the citation of the author's name alone being in such case sufficient.

The Conifers recorded as native to Japan, inclusive of Yesso, admit of being grouped in 13 genera, of which one only is peculiar to Japan, viz. *Sciadopitys*. Two genera are peculiar to Japan and China, viz. *Cryptomeria* and *Cephalotaxus* (unless the Sumatran *C. sumatrana*, a doubtful species, be included). *Ginkgo*, a Chinese genus, is supposed not to be native in Japan, though often cultivated. *Podocarpus* has representatives both in Japan and China; and its species are widely dispersed in tropical and subtropical regions. *Tsuga* and *Torreya* have each of them species in Japan and on both sides of the North-American continent. Several Japanese genera occur also in the Himalaya Mountains. The other genera which have Japanese representatives are widely distributed, especially in the northern hemisphere.

The 13 genera recorded in Japan comprise 41 species, exclusive of varieties and doubtful natives, thus distributed:—*Thuja* (in-

* Veitch's very useful 'Manual of the Coniferæ' was issued only as this sheet was passing through the press; hence I have not been able to cite it as frequently as otherwise I should have done.—June 1881.

cluding *Thuyopsis*, *Biota*, and *Chamæcyparis* or *Retinospora*) has three species peculiar to Japan, including *T. japonica* or *Standishii*; *Juniperus* is represented by five species—three peculiar to Japan, two others common to Japan and China; *Cryptomeria* occurs both in Japan and in China; neither *Taxodium* nor *Sequoia* is found in Japan. *Cephalotaxus* is represented in Japan by three endemic species; a fourth occurs in China. One species of Yew (*Taxus tardiva*) is peculiar to Japan; another is common to that country and China. *Torreya* has one Japanese species; others are found in China, Florida, and California—widely separated regions. *Ginkgo* has been already alluded to. *Podocarpus* has three Japanese species; and others occur in China. *Cunninghamia* is exclusively Chinese, and *Sciadopitys* Japanese. *Pinus* has four species in Japan; but none are peculiar—China, North-east Asia, and in one case Europe even affording them a home. Of *Picea* (Spruce Firs) there are five species in Japan, three of which are peculiar; one is found in Corea also, and the others on the mainland of Temperate East Asia. *Tsuga* has two species peculiar to Japan. The Silver Firs (*Abies*) have three endemic species in Japan, and others common to Japan and North-east Asia. *Larix* has one species endemic to Japan and Yesso.

It may therefore be said that there are 41 species of Conifers in Japan, of which no fewer than 22 are supposed to be endemic; but this estimate will no doubt be diminished as our knowledge of the flora of adjacent regions increases.

Seven or eight species are common to Japan and China, the total in China amounting to about 20 species. Nine or ten species are common to Japan and the mainland of North-east Asia, the total number of species recorded from Manchuria and Amuria being 15. Only one species or variety (*Pinus Cembra*, var. *pumila*) is recorded as common to Japan, North Asia, and America, either on the Atlantic or Pacific sides. In Sachalin only 3 species are as yet recorded, all of which occur also in Japan. From Arctic Asia 6 species are known, none of which extends into Japan. In Siberia 14 species are enumerated, only one or two of which are found in Japan. The few species yet known from the Kurile Islands are also met with in Japan. Six species are known to inhabit Kamtschatka, of which *Pinus koraiensis* occurs also in Japan. The remaining species are of the Siberian group. On the other hand, all the species hitherto found in Corea occur also in Japan. The Conifers of the outlying islands

of Loo Choo, Hong Kong, and Bonin are, as might have been expected, of Chinese rather than of Japanese affinity. There is also a large number of species in America, the Himalayas, and Europe; but, with the one exception mentioned, none is common to these regions as well as to Japan.

For various reasons, the figures just given may not be strictly accurate; they are liable to alteration as our knowledge increases, and according to the views entertained by particular botanists as to the identification and limitation of species; but for our present purpose they are sufficiently correct, as it is not likely that the proportions which those figures represent will be materially changed.

Although the species may not be absolutely identical, yet Pines, Larches, Silver Firs, Spruce Firs, Junipers, Yews are represented in each of the geographical districts mentioned. The Hemlock Spruces (*Tsuga*) of Japan have representatives on both sides of the American continent, as well as in the Himalaya. The dwarf Cypresses of Japan (*Thuya* § *Chamæcyparis*) have also representatives on both sides of the American continent; while *Thuya japonica* is so like the *T. gigantea* of the North-west American region that it has been mistaken for it. *Thuya orientalis*, too, may be said to have its American representative in *Thuya occidentalis*. *Picea ajanensis* of the North-east Asiatic regions has, from its similarity, been confused with the *Picea sitkensis* or *Menziesii* of North-west America. *Juniperus nipponica* is almost identical with *J. nana* from Sitka. The curious distribution of the species of *Torreya* has been already referred to.

The large number of endemic species with one endemic genus, leads to the inference that Japan may have formed a special centre whence Conifers have migrated elsewhere. This view seems more probable than the assumption that Japan has received any but a small proportion of its Conifers from elsewhere. Numerically, as might be expected, the alliance is greatest between Japan and China and the mainland to the north of the latter empire. The approximation to the American flora, especially to that of the east side of that continent, is numerically extremely small; indeed there is not a single Conifer common to Eastern America and Japan. But when representative species are taken into account, the relation is shown to be closer, though still less than that (illustrated by other orders of flowering plants) pointed out by Dr. Asa Gray. In his well-known essay on the Botany of

Japan*, Dr. Gray calls special attention to the analogies between the floras of the Eastern United States and that of Japan. From his address to the American Association the following list of Conifers is taken, from among the numerous other plants, showing the analogy of the American and Japanese floras :—

<i>Atlantic.</i>	<i>Pacific.</i>	<i>Japan and N.E. Asia.</i>
PINUS.		
resinosa.		densiflora.
Strobos.	monticola.	excelsa.
TSUGA.		
canadensis.	Mertensiana.	Sieboldii and diversifolia.
THUYA.		
occidentalis.	gigantea &c.	japonica.
TAXODIUM.		
distichum.		heterophyllum.
CUPRESSUS (Chamæcyparis).		
thuyoides.	nutkaensis.	pisifera and obtusa.
TAXUS.		
canadensis.	brevifolia.	cuspidata.
TORREYA.		
taxifolia.	californica.	nucifera and grandis.

Dr. Gray concludes (and he is supported by Oliver and others) that a very peculiar analogy exists between the floras of Tertiary Central Europe and the recent floras of the Eastern American States and Japan. It is supposed that, at some period of the Tertiary epoch, N.E. Asia was united to the north-western part of America, probably along the line now occupied by the Aleutian Islands. Assuming the former existence of land-communication between the three continents in the extreme north, the prevalence of a relatively warm climate, as indicated by the fossil plants found in arctic regions, then it is supposed that on the access of the Glacial Period, plants were driven southwards in various directions, according to local circumstances not as yet fully determined. In this way it is suggested that some plants found a refuge in Asia, some in Eastern, and some in Western America†. The presence of northern types in Japan may be accounted for on such a supposition. But, in addition, there is a large proportion of species which appear to be endemic in Japan, and of which we have no traces northwards. These are so numerous in the case

* A. Gray, Botany of Japan, U.S. Exploring Expedition, p. 433 (1858); also Address to the American Association for the Advancement of Science, Dubuque (1872). Hooker, Flora of N.E. Asia and N.E. America. Gardeners' Chronicle, Aug. 17, 1878, p. 216.

† Murray, 'Geographical Distribution of Mammals' (1866), p. 47.

of the Conifers as to lead to the conclusion before expressed, that Japan must for these plants be taken as a centre of dispersal. That there has been a migration from the polar regions southward is admitted on all sides; and that many species have been stopped in their southward course by the increasing temperature, is illustrated by the distribution of the Conifers in Japan. Some species, as I learn from Mr. Maries, occur in the lowlands of Yesso and on the mountains of the central island, as if the climate of the more southern lowlands were too hot for them, or offered such advantages to other species that the Conifers were crowded out by the more vigorous growth of their competitors. On the other hand, tropical or subtropical types, such as *Podocarpus*, are not able to extend far to the north.

Not a single species is common to Europe and Eastern America. If, however, we look to the genera, we find them, as has already been said, with the exception of the one or two supposed endemic Japanese genera, belting the globe and represented in every part of the northern hemisphere. A certain number of representative species have also been pointed out; and the "representation" must necessarily be closer between some species than between others. This relative closeness of affinity may, in the absence of more direct evidence, afford a clue to the direction in which migration has taken place. Adverting, therefore, to the list of representative Conifers spoken of by Dr. Gray, it will be seen that the representative species of Japan and of Western North America are more closely allied than those of Japan and of Eastern North America: compare, for instance, *Picea ajanensis* and *Thuja japonica* (Japan) and *P. sitchensis* and *T. gigantea* (N. W. America). Moreover the number of representative species in relation to those of Japan is greater, though only slightly so, on the western than on the eastern side of the American continent. The facts are too few to base safe inferences on; but it is at least a reasonable conjecture that Japan did not receive its special Coniferous flora from the north, because so few of the arctic species or of those from Northern Asia or Northern America are found in Japan. *Abies alba* and the Oregon and British-Columbian species, none of which occurs in Japan, are instances in point. Moreover, forms which were common in the arctic regions (and, indeed, in various parts of what is now temperate Europe) in the Miocene epoch, and which exist now in a living state in America under conditions which are not dissimilar to those which may be

met with in Japan, nevertheless have not hitherto been discovered in any part of Japan—e. g. *Sequoia*. It is also at least possible, assuming Japan to have been a distinct centre, that at some time migration may have taken place principally westward to Asia, and to a less extent eastward to the Pacific side of America.

With reference to the fossil species of this order, it behoves me to speak with great diffidence, inasmuch as I have made no special study of them. Judging, however, from the great range of variation in existing species, and the stages of growth they pass through, it would seem that the data upon which the student of fossil plants has often to deal must be peculiarly unsafe as guides to the discrimination of species in this order. Where the different stages or forms of growth exist, as they sometimes do, on the same tree or shrub, as in the Chinese Juniper, there is no difficulty about the matter; but this fortunate state of things is the exception rather than the rule. Take, for instance, the numerous Japanese forms of the *Retinospora*-group. These forms belong to different genera, are widely different one from another and from the perfect tree; and for the most part they preserve their characters without change, at least under cultivation. The consequence is that they are taken as so many distinct species by those who have not had the opportunity of seeing the passage from the one to the other. The student of fossil plants, meeting with analogous isolated forms, would be almost certain to enumerate them all as separate and distinct species; the evidence before him would not suggest any other course. The instance of *Abies bifida* and *A. firma* is another case in point. The two stages represented by those names are so different, the internal anatomical structure of the leaves and the arrangement of the resin-canals so very distinct, that they have been considered as belonging to separate species. Large cultivated specimens in our nurseries are so different that they are, with very good reason, sold as separate species; and the workmen accustomed to handle them, and whose appreciation of the points of difference between forms is often much keener than that of the professed botanist, are apt to express the greatest astonishment when told that *A. bifida* and *A. firma* are one and the same. The evidence in support of this statement is given under the head of *A. firma*. Such cases (and they are not infrequent in Conifers) should make descriptive botanists pause before establishing new species.

Whatever caution may be deemed necessary as to the interpre-

tation to be put on the fossilized remnants of plants, so far as their specific identity is concerned, there is no reason to doubt the existence of representatives of many existing genera in various epochs of the world's history. *Glyptostrobus*, *Taxodium*, *Sequoia*, and *Ginkgo* may be specially mentioned, on account of their existence in high northern latitudes where they can no longer grow, their wide distribution in former times, and the very important inferences that have been drawn from these circumstances. It is noteworthy that neither *Taxodium* nor *Sequoia* has hitherto been found in a living state in Japan*.

Before leaving the subject of the distribution of Japanese Conifers, a word may be said as to the occurrence of certain trees (often of peculiar organization) in the immediate vicinity of the temples in Japan, China, Tibet, &c. In some of these cases the trees are not known in a wild state, the aboriginal stocks being either extinct or lurking in some of the all but unknown districts of the Chinese empire, Tibet, or Central Asia. Among such may be mentioned, as worthy the attention of the students of Buddhist lore, *Cupressus funebris* (China, Sikkim), *Abies Fortunei* (China), *Abies Kämpferi* (China), *Cryptomeria japonica*, *Sciadopitys verticillata*, *Ginkgo biloba*, and certain species of *Pinus*.

Mention has already been made of the various forms under which one and the same species occur. Carrière has called these transitional or immature forms "larval" stages; and I have alluded to them under the head of Stasimorphy in my 'Vegetable Teratology.' In many cases the appearances depend simply on greater or less energy of growth at particular times. Arrest and progress of growth in more or less regular alternation and intermittence will generally account for the diversity in form and arrangement of the leaves. The tufted leaves of the Pines and

* See Heer, 'Catalogue of North-Greenland Miocene Plants' (1866); also 'Ueber einige fossile Pflanzen von Vancouver und britisch Columbien,' 'Die miocäne Flora und Fauna Spitzbergens,' 'Primit. Flor. fossilis Sachalinensis' (1878), "Zur Geschichte der Ginkgoartigen Bäume" in Engler's Bot. Jahrb. i. (1880), p. 1, and 'Flora fossilis arctica,' Asa Gray, Address, *op. cit.*; Hildebrand, "Verbreitung der Conif. in der Jetztzeit und in den früheren geologischen Perioden" (1861), Verhandl. d. natur. Ver. für Rheinland und Westphal., neue Folge, viii. (this memoir gives a complete list of the existing and fossil species of Conifers known at the time of publication, together with indications of their geographical distribution); F. Schmidt, 'Die miocäne Flora von Sachalin,' 1880; Engler, 'Versuch einer Entwicklungsgeschichte der Pflanzenwelt, &c. (1879); J. Starkie Gardner in 'Nature,' 1881, *passim*.

Larches indicate an arrest in growth of the axis ; but it is very common to find a shoot elongating, and bearing the leaves in scattered spirals. Sometimes these spirally arranged and scattered leaves in *Pinus* are merely the bud-scales or "perulæ" which have assumed a leafy development. Such leaves also have essentially the same anatomical structure as the ordinary ones. So, in the case of the *Retinosporas*, in the "larval" state the leaves are free and detached from the stem, but in the mature plant the leaves remain in adhesion with, or never separate from, the stem, except at the tips. The internal structure of the various forms of the leaves in *Retinospora* and *Juniperus* is essentially the same, but more spongy in the faster-growing leaves. In *Libocedrus decurrens* it seems as if the axillary bud were also adherent to the stem, and uplifted with it during its growth ; for it proceeds from the stem, not at the organic base of the leaf, but at the point where the leaf becomes detached from the stem. This may be the result of an arrest of growth. But if this be so, it is by no means easy to determine what causes the arrest, what stimulates the progress, particularly when these are confined to one or a few branches. Similarity of surroundings and outward conditions naturally engenders a similar disposition of parts : thus in the leading shoot of a *Picea* the leaves are in scattered spirals, while on the horizontal branches the spiral is so masked by the crowding of the leaves and the twisting that occurs at their base that there is a pseudo-distichous arrangement, and the uppermost leaves are often shorter than the lower ones. In the leading shoot, in such cases, we have an analogous arrangement to what occurs in *Lycopodium* ; on the lateral branches the arrangement suggests that of *Selaginella*. The interest attaching to these varied forms of one and the same individual is enhanced by their suggestiveness in regard to the possible lineage of the species, a matter hardly more than broached. They may possibly represent the condition of some progenitor ; or such a genus as *Retinospora* (so called) may be one in course of formation. The student of fossil plants might help us to the solution of this problem.

In the following table the single line — indicates the occurrence of a species, the double line = that of a genus, in the district to which the column refers. The distribution of the fossil genera is not indicated in detail.

TABLE showing the names of the Conifers native to Japan, their Geographical Distribution and that of nearly allied or representative species.

	Japan.	Arctic Asia.	Siberia; Kamtschatka.	Kurile Islands.	Manchuria; Amuria.	China.	Sachalin.	Yesso.	Arctic America.	North-west America.	East America.	Himalaya.	Europe.	Fossil genera.
LIBOCEDRUS
<i>decurrens</i>
<i>macrolepis</i>
THUYA
<i>dolabrata</i>
<i>japonica</i>
<i>orientalis</i>
<i>pisifera</i>	?
<i>obtusa</i>
<i>excelsa (nutkaensis)</i>
<i>gigantea</i>
<i>occidentalis</i>
THUYITES
CUPRESSUS
<i>funebriis</i>	?
CUPRESSITES &c.
JUNIPERUS
<i>rigida</i>
<i>nipponica</i>
<i>conferta</i>
<i>taxifolia</i>
<i>chiuensis</i>
<i>davurica</i>
<i>communis</i>
—, var. <i>nana</i>
<i>sphærica</i>
<i>virginiana</i>
<i>Sabina</i>
<i>pseudo-Sabina</i>
<i>occidentalis</i>
JUNIPERITES
CRYPTOMERIA
<i>japonica</i>
VOLTZIA
TAXODIUM
<i>heterophyllum</i>
<i>distichum</i>
SEQUOIA
<i>gigantea</i>
<i>sempervirens</i>
CEPHALOTAXUS
<i>drupacea</i>
<i>pedunculata</i>
<i>umbraculifera</i>
<i>Fortunei</i>

TABLE (continued).

	Japan.	Arctic Asia.	Siberia; Kamtschatka.	Kurile Islands.	Manchuria; Amuria.	China.	Sachalin.	Yesso.	Arctic America.	North-west America.	East America.	Himalaya.	Europe.	Fossil genera.
TAXUS														
<i>cuspidata</i>														
<i>tardiva</i>														
<i>baccata</i>														
TAXITES														
TORREYA														
<i>nucifera</i>														
<i>grandis</i>														
<i>californica</i>														
<i>taxifolia</i>														
GINKGO														
<i>biloba</i>		?												
PODOCARPUS														
<i>Nageia</i>														
<i>cæsia</i>														
<i>appressa</i>														
<i>macrophylla</i>														
<i>chinensis</i>														
<i>cuspidata</i>														
<i>grandifolia</i>														
<i>japonica</i>														
<i>koraiana</i>														
CUNNINGHAMIA														
<i>sinensis</i>														
CUNNINGHAMITES														
SCIADOPITYS														
<i>verticillata</i>														
PINUS														
<i>densiflora</i>														
<i>Thunbergii</i>														
<i>parviflora</i>							?							
<i>koraiensis</i>														
<i>Cembra</i>														
—, var. <i>pumila</i>														
<i>silvestris</i>														
<i>Massoniana</i>														
<i>Bungeana</i>														
<i>contorta</i>														
<i>Khasya</i>														
<i>Banksiana</i>														
PINITES														
PICEA														
<i>obovata</i>														
—, var. <i>Schrenkiana</i>														
<i>Maximowiczii</i>														
<i>polita</i>														
<i>Alcockiana</i>														
<i>ajanensis</i>														
<i>Glehnii</i>														

TABLE (continued).

	Japan.	Arctic Asia.	Siberia; Kamtschatka.	Kurile Islands.	Manchuria; Amuria.	China.	Sachalin.	Yesso.	Arctic America.	North-west America.	East America.	Himalaya.	Europe.	Fossil genera.
<i>Picea tianschanica</i>
<i>sitkensis</i>
<i>alba</i>
<i>nigra</i>
<i>excelsa (Link)</i>
<i>orientalis</i>
TSUGA
<i>Sieboldi</i>
<i>diversifolia</i>
<i>canadensis</i>	?
<i>Mertensiana</i>
<i>Pattoniana</i>
<i>dumosa</i>
PSEUDOTSUGA
<i>Douglasii</i>
ABIES
<i>firma</i>
<i>brachyphylla</i>
<i>Veitchii</i>
<i>homolepis</i>
<i>Mariesii</i>
<i>sachalinensis</i>
<i>sibirica</i>
<i>Fortunei</i>
ABIETITES
LARIX
<i>leptolepis</i>
<i>davurica</i>
<i>Kaempferi</i>
<i>sibirica</i>
<i>pendula</i>
Species	41	6	14	5	20	23	5	8	7	18	7	7	7	9

Enumeration of the Coniferous Plants of Japan and neighbouring Countries.

LIBOCEDRUS, Endl., Parlatore, Benth. et Hook.

L. MACROLEPIS, Benth. et Hook. Gen. Pl. iii. p. 426.

Calocedrus macrolepis, Kurz, in Trimen's Journal of Botany, 1873, p. 196, tab. 133. fig. iii.

Yunan, Hotha, Anderson!

Mr. Bentham refers this plant to *Libocedrus*, thus extending the geographical distribution of this genus, already sufficiently remarkable, inasmuch as one species is native of New Zealand, two others of Chile, and another of the Rocky Mountains between 38° and 41°. The Yunan plant has the habit of *Thuja* § *Thuyopsis*, and is intermediate between it and true *Libocedrus*. The genus is known also in a fossil state in deposits of the Miocene period.

THUYA, *Linn.*; *Benth. et Hook.*

§ *Thuyopsis*, *Benth. et Hook.*

T. DOLABRATA, *Linn. Suppl.* p. 420 (1781); *Thunberg, Flora Japonica*, p. 266; *Lambert; Miquel.*

Platyclusus dolabrata, *Spach, Hist. Veg. Phan.* xi. p. 337 (1842).

Thuyopsis dolabrata, *Sieb. et Zucc. Fl. Jap.* ii. p. 34, t. 119, 120; *Endlicher; Lindley and Gordon; Carrière; Gordon; Henk. et Hochst.; Parlatores, in DC. Prod.* xvi. 2, p. 460; *Franchet et Savatier; Koch.*

In Japonia, *Kämpfer!*; in montanis Kiousiou, ad Nagasaki, *Oldham*, 799!; Nippon, *Thunberg!*, *Siebold!*, *Buerger!*; Yokohama, *Maximowicz!*; Yokoska, *Savatier;* Yeddo, *Fortune!*, *Reeves!* An undershrub in the mountains of Central Japan, alt. 7000–8000 feet, *Maries!*

Var. NANA, *Sieb. et Zucc. l. c.; Endlicher; Carrière.*

Var. VARIEGATA, *Gord. Suppl.* p. 100; *Pinetum*, ed. 2, p. 400; *Carrière.*

Var. LÆTE-VIRENS:

Thuyopsis læte-virens, *Lindl. in Gard. Chron.* 1861, p. 56; *Carrière; Henk. et Hochst.*

Thuyopsis dolabrata nana, *Gordon, Pinetum*, ed. 2, p. 399. Yokohama, *Maximowicz!*

Carrière considers this distinct from var. *nana*; but *Gordon* treats them as identical.

§ *Macrothuya*, *Benth. et Hook.*

T. JAPONICA, *Maximowicz in Diagn. Plant. Jap.* decas 1 (1866), p. 26, in *Mélanges Biolog. St. Pétersbourg*, t. vi.; haud *T. japonica* hort. Angl.

Thuja Standishii, *Carrière, Traité Général*, ed. 2, p. 108 (1867) *Gordon, Pinetum*, ed. 2, p. 408; *Mast. in Gard. Chron.* Sept. 28, 1878, p. 397.

Thuyopsis? *Standishii*, *Gordon, Suppl.* p. 100 (1862).

Thuya gigantea, *Parlatore in DC. Prod.* xvi. 2, p. 457 (1868); *Koch*; (haud *Nuttall*).

Thuya gigantea, var. *japonica*, *Franchet et Savatier, Enum. Plant. Jap.* i. p. 469 (1875).

"In Japonia spontanea?, in urbe Yedo vidit cultam cl. Maximowicz! Fortasse ex America boreali introducta," *Franchet et Savatier, l. c.* In ins. Nippon ad montes una cum *T. dolabrata* crescens, *Maries in litt.*!

This is a plant of much interest—from its structure, as it has been placed sometimes in *Thuyopsis*, sometimes in *Thuya*; from its history, because it has been supposed to be cultivated only in Japan, and to have been introduced from Western America, and to be, in fact, only a cultivated variety of *T. gigantea*, Nutt. As a genus, *Thuyopsis* was separated from *Thuya* on account of the presence of five seeds to each fertile scale, the true *Thuya* having but two. The plant before us has, in cultivation, usually three seeds to each fertile scale, as has also the American *T. gigantea*, which is therefore included in the section *Macrothuya* by Bentham and Hooker.

Up till lately it has not been known in a wild state in Japan; but Mr. Maries assures me that the plant grows on the mountains of Central Japan, together with *T. dolabrata*; and plants are now growing in Messrs. Veitch's nursery, from seed sent home from this district by him.

On the assumption that it was of American origin, the differences that exist between it and *T. gigantea*, though intrinsically slight, become of much interest. Mr. Syme, whose knowledge of cultivated Conifers is so thorough, concurred with Parlatore in considering our present plant a form of *T. gigantea*; but at the time that he expressed that opinion he was not aware of the existence of *Thuya japonica* in Japan in any other than a cultivated form.

From the American *T. gigantea* the Japanese plant may be distinguished by its branches, which are more rounded and not so flattened as in *T. gigantea*, in which they are even concave on the lower surface—by its leaves, which are oblong-obtuse, not broadly ovate and sharply acuminate, and which are moreover marked by a conspicuous gland—and by its cones, which are more nearly globose than in the American plant, in which they are oblong. The scales of the cone in the two species follow nearly

the same rule as the leaves. Lastly, the seeds in the Japanese plant are nearly equal to the scales in length, and the wing of the seed is nearly entire, while in *T. gigantea* the seeds are distinctly shorter than the scales, and the wing is deeply notched.

Mr. Syme (*in litt.*) points out to me that the bark of the young Japanese plant is rough and shaggy, while that of the American plant is quite smooth. To the same accurate observer I am indebted for the note that the male catkins of the Japanese plant more nearly resemble those of *T. dolabrata* than they do those of *T. gigantea*. Mr. Syme leans to the view that at some remote period the Japanese imported *T. gigantea* from America, and that, under cultivation and the general conditions of life in Japan, the plant has taken on its varietal character.

§ *Biota, Benth. et Hook.*

T. ORIENTALIS, *Linn. Sp.* ed. 1 (1753), p. 1002; ed. 2, p. 1422; *Thunberg, Flora Jap.* (1784) p. 266; *Richard*; *Siebold et Zucc. Flor. Jap.* ii. p. 31, et t. 118; *Miquel*; *Loudon et aliorum.*

Biota orientalis, *Endl. Syn. Conif.* (1847) p. 47; *Lindl. et Gordon, Journ. Hort. Soc.* v. p. 205; *Carrière*; *Gordon*; *Parlatore in DC. Prod.* xvi. 2, p. 461; *Koch*; *Franchet et Savatier.*

In regione montana insularum Nippon et Sikok; Nagasaki, *Oldham!*; Yokohama, *Maximowicz!*; Yokoska, *Savatier, ex Franchet et Savatier, Buerger!*, *Fortune!*

Var. β . PENDULA, *Parlatore in DC. Prod.* xvi. 2, p. 462.

Cupressus pendula, *Thunberg, Fl. Jap.* p. 265.

Biota pendula, *Endlicher*; *Carrière*; *Gordon.*

Thuja pendula, *Lambert*; *Sieb. et Zucc. Fl. Jap.* ii. p. 30, t. 117; *Miquel.*

T. filiformis, *Lodd. in Bot. Reg.* (1842) t. 20.

In Japonia, *Thunberg, Siebold, Buerger!*, *Maximowicz!*; in montibus Hakone, *Savatier*; Yeddo, *Fortune!*; in China, *Fortune!*, *Reeves!*

This plant (the Chinese *Arbor vitæ* of our gardens) is remarkable for the great variations it presents in the shape of its cones, its habit, foliage, &c. Hence, in gardens, a very large number of seedling variations are met with, while other varieties represent simply the immature or "larval" form of the species.

Several of these forms are described by *Endlicher*; others are figured and described in *Hoopes's 'Book of Evergreens,'* p. 334 &c.). The plant, though truly wild in Japan and in China, has

been cultivated for a very long series of years, and the varieties carefully selected and propagated.

The variety *pendula*, which is very distinct-looking, from its weeping slender branchlets and free, not congenitally adnate leaves, produces cones from which seedlings of the ordinary form of *T. orientalis* have been raised.

Fig. 1.

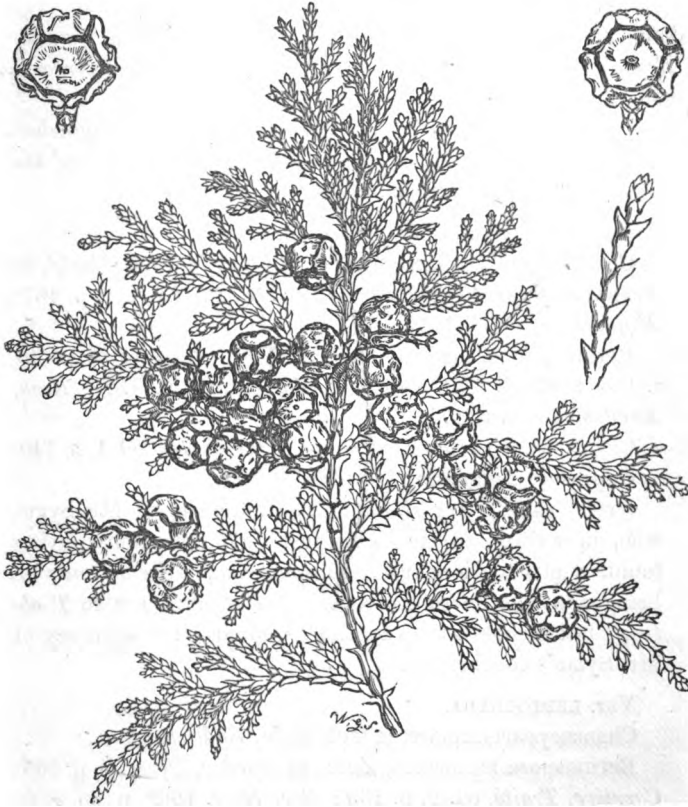

Thuya pisifera. Foliage and cones from a cultivated specimen; nat. size and magnified.

§ *Chamæcyparis*, *Benth. et Hook.*

T. PISIFERA. (Fig. 1.)*

Retinispora pisifera, *Sieb. et Zucc. Fl. Jap.* ii. p. 39, t. 122 ;

* The illustrations in this paper are reproductions from those which have appeared in the 'Gardeners' Chronicle.'

Gordon; *Miquel*; *Syme in Gard. Chron.* vol. v. 1876, p. 237, fig. 44.

Chamæcyparis pisifera, *Sieb. in Endl. Conif.* p. 64, ex *Parlatore in DC. Prod.* xvi. 2, p. 465; *Franchet et Savatier*; *Carrière*; *Miquel*.

Cupressus pisifera, *Koch, Dendrol.* ii. p. 170 (1873).

In Japonia, *Kämpfer*!; in montanis Kioussiou, prope Nangasaki, *Siebold*!, *Oldham* 401!; Nippon in monte Fudsi et in jugo Hakone, *Buerger*!; Yokohama, *Maximowicz*!; Yokoska, *Savatier ex Franchet et Savatier*, *Fortune*!, *Veitch*!, *Wright*!, *Buerger*!; Yunan, ubi culta, *Anderson*!

There are numerous seedling variations in gardens, distinguished by their golden or silvery-white variegation, especially in the spring months, their dwarf habit, &c.

Var. SQUARROSA.

Chamæcyparis squarrosa, *Sieb. et Zucc. in Endl. Conif.*, ex *Franchet et Savatier*; *Parlatore in DC. Prod.* xvi. 2, p. 467; *Miquel*.

Retinispora squarrosa, *Sieb. et Zucc. Fl. Jap.* ii. p. 40, t. 123!; *Gordon*; *Carrière, Traité*, ed. 2, p. 137; *Koch, Dendrologie*, ii. p. 171.

Chamæcyparis ericoides, *Carrière, Traité Gen.* ed. 1, p. 140.

Cupressus squarrosa, *Laws.*, ex *Gordon*.

I refer this to *T. pisifera* on the authority of Mr. Syme, who, in writing to me in August 1879, mentions having found a pisiferoid sport from *squarrosa*, differing only in being somewhat more glaucous. Meehan refers it to *T. obtusa*; but Siebold's type specimens confirm the accuracy of Mr. Syme's conclusions.

Var. LEPTOCLADA.

Chamæcyparis squarrosa leptoclada, *Endlicher*.

Retinispora leptoclada, *Zucc.*, ex *Gordon, Pinet.* ii. p. 365; *Carrière, Traité*, ed. 2, p. 139; *Rev. Hort.* 1869, p. 95, c. ic.

Var. PLUMOSA. (Fig. 2.)

Chamæcyparis obtusa plumosa, *Carrière, Traité*, ed. 2, p. 791.

Retinispora plumosa, hort., *Syme in Gard. Chron.* vol. v. 1876, p. 236, fig. 42 (ramus et strobili).

I follow Mr. Syme in treating this as a variety of *T. pisifera*. The cones are smaller than those of *T. pisifera*,

their scales smoother and more even. The greatest proof of their identity consists in the fact, made known by Mr. Syme, "that the *B. plumosa* of gardens occasionally throws out branches with all the characteristics of *pisifera*."

Fig. 2.



Thuya pisifera, var. *plumosa*. Foliage and cones from a cultivated plant; nat. size and magnified.

Var. *FILIFERA*. (Fig. 3.)

Retinospora filifera, *Standish*, ex *Gordon*, *Pinetum*, ed. 2, p. 364; *Syme in Gard. Chron.* vol. v. (1876), p. 237, fig. 43 (ramulus et strobili).

Mr. Syme regards this either as a variety of *pisifera* analogous to the pendulous form of *T. (Biota) orientalis*, or as a form of *orientalis* itself.

T. OBTUSA. (Fig. 4.)

Chamæcyparis obtusa, *Sieb. et Zucc. in Endl. Conif.* p. 63; *Carrière, Traité*, ed. 2, p. 129; *Franchet et Savatier*; *Parlatore in DC. Prod.* xvi. 2, p. 466; *Miquel*.

Retinispora obtusa, *Sieb. et Zucc. Fl. Jap.* ii. p. 38, t. 121 ;
Miquel ; *Syme in Gard. Chron.* vol. v. (1876) p. 236, fig. 41.

Cupressus obtusa, *Koch, Dendrol.* ii. p. 168.

Fig. 3.



Thuja pisifera, var. *filifera*. Foliage and cones from a cultivated plant ;
 nat. size and magnified.

In regionibus montanis silvas efformans Kioussiou circa Nangasaki, Mohnike, Nippon ad Yokohama, *Maximowicz* ! ; Yokoska, *Savatier*, *Siebold* !, *Oldham* 354 !

Of this species several varieties or cultivated forms exist to which specific names have, inappropriately as it turns out, been given. Most of them are interesting morphologically, and as showing the possible range of variation in these plants. They

are also desirable plants for gardens. The more important of them may be here specified :—

Var. LYCOPODIODES, *Carrière, Traité Gén.* ed. 2, p. 132.
Retinospora lycopodioides, Gordon ; Parlature in DC. Prod. xvi. 2, p. 466 ; *Koch, Dendrol.* ii. p. 169.

Var. PYGMÆA, *Carrière, Traité Gén.* ed. 2, p. 131.
Retinospora obtusa pygmæa, Gordon ; Parlature in DC. Prod. xvi. 2, p. 466 ; *Koch, Dendrol.* ii. p. 169.
Thuya pygmæa, hort.

Fig. 4.

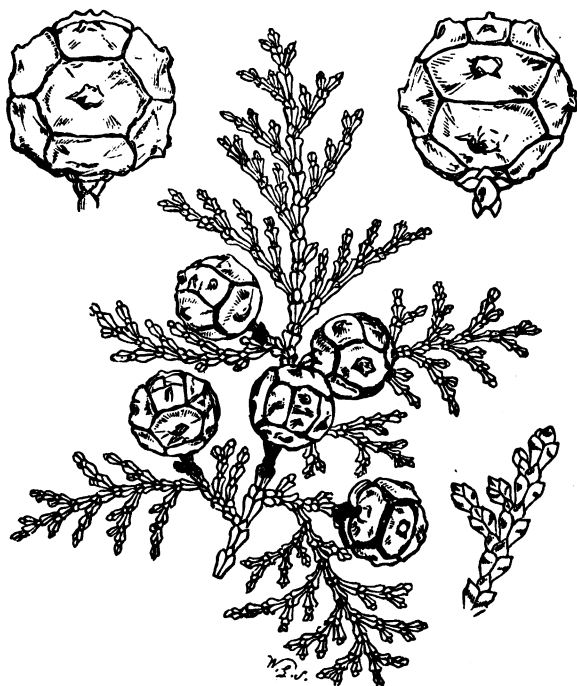

Thuya obtusa. Foliage and cones from a cultivated plant ; nat. size and magnified.

Var. NANA, *Carrière, Traité Gén.* ed. 2, p. 131.
Retinospora obtusa nana, hort. cum varietatibus aureo nec non argenteo variegatis.

Var. KETELEERII, *hort. Standish ; Parlature in DC. Prod.* xvi. 2, p. 466 ; *Koch, Dendrol.* ii. p. 169.

Var. BREVIRAMEA.

Chamæcyparis breviramea, Maxim. *Mélanges Biol.* vi. p. 25 (1866); Miquel; Franchet et Savatier.

"In littore boreali ins. Kioussiou mare Japoniæ mediterraneum spectans inter *C. obtusam* crescens," Maximowicz!, Franchet et Savatier; sæpe in hort. Yedoensibus culta.

Var. PENDULA.

Chamæcyparis pendula, Maxim. *Mélanges Biol.* vi. p. 25 (1866); Miquel; Franchet et Savatier.

In hortis urbis Yeddo, Maximowicz, Savatier.

This is like the *pendula* form of *Biota orientalis*.

Fig. 5.

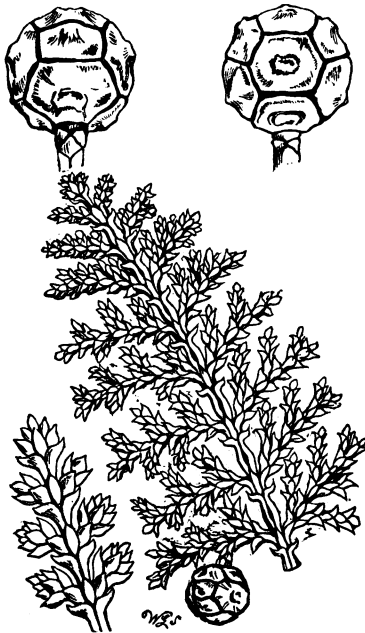

Thuya obtusa, var. *filicoides*. Foliage and cones from a cultivated plant; nat. size and magnified.

Var. FILICOIDES. (Fig. 5.)

Retinospora filicoides, hort., Syme in *Gard. Chron.* vol. v. (1876) p. 235, fig. 40 (ramus et strobili); Gordon, *Pinetum*, ed. 2, p. 363.

Mr. Syme regards the cones of this as identical with those of *obtusa*, only that they are smaller.

Thuyites, the fossil representative of *Thuya*, is found in the Miocene, Wealden, and Oolite strata.

In addition to the species and forms above mentioned, others are named in gardens and garden-catalogues. Such are:—*Retinospora ericoides*, *pseudo-squarrosa*, *juniperoides*, *decussata* (= *T. orientalis*), *decurvata*, *dubia*, *japonica*, *Devriesiana*, *tetragona*, &c. It is impossible, with the material at command, to assign these forms to their sources. In gardens, indeed, the same name is often applied to different plants. Thus there are different plants bearing the names of *japonica*, *squarrosa*, and *ericoides*. Of the latter one is a form of *T. occidentalis*, another of *T. obtusa*, a third of *T. pisifera*, a fourth of *T. sphaeroidea*, &c. As the history and course of development are not known, it is impossible to disentangle the confusion. Most of them are juvenile forms or immature states of some species of *Thuya* or Juniper, some have arisen as bud-variations, others as seedling varieties. Very few are known in the wild state, even in Japan*.

* M. Carrière says, in the 'Revue Horticole' for 1880, pp. 36, 93, and 177, that *Retinospora Ellwangeriana* is a "larval" form of *Thuya occidentalis*, *R. dubia* of *Thuya* sp., *R. juniperoides* of *Thuya orientalis*. *Biota meldensis* [once] supposed to be a hybrid between *Biota orientalis* and *Juniperus virginiana* [is now known to be a form of *T. orientalis*]. *R. squarrosa* is mentioned as a larval form of some unknown species; *R. pseudo-squarrosa* as a seedling variety of *T. (Chamæcyparis) sphaeroidea*; and *C. andelyensis* is said to have had a similar origin from the same type, although it has been re-baptized by English nurserymen as *Retinospora leptoclada* (not of Siebold). M. Carrière gives the following synonymy:—

1. *R. DUBIA*, Carr. *Traité Général des Conifères*, ed. 2, p. 141; *Chamæcyparis ericoides*, hort.; *Thuya japonica*, hort.; *Thuya ericoides*, hort.; *Thuya Devriesiana*, hort. Germ.
2. *R. ELLWANGERIANA*, Carr. *Rev. Hort.* 1869, p. 349, cum ic.; *Thuya Ellwangeriana*, hort. [a form of *Thuya occidentalis*].
3. *R. JUNIPEROIDES*, Carr. *Traité*, ed. 2, p. 140; *Rev. Hort.* 1869, p. 307, cum ic.; *Juniperus ericoides* hort.; *Chamæcyparis decussata*, hort.; *Retinospora recurvata*, hort.; *R. glauca*, hort.; *R. squarrosa*, hort., non Sieb.; *Cupressus ericoides*, hort.; *Retinospora rigida*, Carr. MSS. = *T. orientalis*.
4. *R. LEPTOCLADA*, Zucc., Carr. *Rev. Hort.* 1869, p. 95, cum ic.; *R. squarrosa*, hort., non Sieb. et Zucc.; *Chamæcyparis squarrosa leptoclada*, Endl.; *Retinospora squarrosa leptoclada*, hort., non Gordon; *Chamæcyparis leptoclada*, Henk. et Hochst.; *Retinospora argentea*, hort.
5. *R. MELDENSIS*, Carr. *Traité*, ed. 2, p. 103; *Juniperus meldensis*, hort.; *Biota meldensis*, Laws.; *B. orientalis*, var. *meldensis*, Carr. *Traité*, ed. 2, p. 103 (*Hoopes*, l. c. p. 339); *Thuya meldensis*, hort.; *T. hybrida*, hort.; *T. orientalis meldensis*, hort.

CUPRESSUS, *Linn.*; *Benth. et Hook.*

C. FUNEBRIS, *Endlicher, Conif.* p. 58; *Parlatore in DC. Prod.* xvi. 2, p. 471, *et auct.*

Cupressus pendula, *Staunt. Embassy*, i. p. 525, t. 41; *Lamb. Pinus*, ed. 2, p. 124, t. 66; *Loud. Arbor.* iv. p. 2479, fig., excl. syn.

In China ad busta et tumulos tantum plantata, *Staunton, Fortune!* Colitur etiam in Sikkim et in Bootan *Hook. fl.* qui putat plantam ex Thibeto allatam.

C. Corneyana (Knight, Synopsis), *Parlatore, l. c.* p. 470, is not known in a wild state, and there is no authority for the statement that it is a native of Japan: see Veitch, Manual, p. 239.

JUNIPERUS, *Linn.*; *Benth. et Hook.*

J. RIGIDA, *Sieb. et Zucc. Fl. Jap.* ii. p. 109, t. 125; *Parlatore in DC. Prod.* xvi. 2, p. 480; *Miquel*; *Endlicher*; *Carrière.*

J. communis, *Thunberg, Fl. Jap.* p. 264, excl. syn.

In Japonia, *Wright!*; *Veitch.*

J. NIPPONICA, *Maxim. Mél. Biol.* vi. p. 374; *Franchet et Savatier.*

In alpibus provinciæ Nambu, Nippon borealis, *Maximowicz, Tschonoski!*

J. LITTORALIS, *Maxim. Mél. Biol.* vi. p. 375 (1867); *Franchet et Savatier.*

Juniperus conferta, *Parlatore in DC. Prod.* xvi. 2, p. 481 (1868).

In arenosis maritimis Kioussiou, *Wright!*; Yeddo, *Maximowicz*; Yokoska, *Savatier*; Nambu, *Maximowicz*; Yesso prope Hakodate, *Maximowicz!*

J. TAXIFOLIA, *Hook. et Arn. Bot. Beechey's Voy.* p. 271; *Par-*

6. *R. ANDELYENSIS*; *R. squarrosa leptoclada*, *Gord., non Endl.*; *Chamæcyparis sphæroidea andelyensis*, *Carr. Traité*, ed. 2, p. 123; *Thuya leptoclada, hort.*; *R. leptoclada, hort. Angl., non Zucc.*, a form of *T. (Chamæcyparis) sphæroidea.*

7. *R. SQUARROSA*, *Sieb. et Zucc. Fl. Jap.* ii. p. 40, t. 123, *non hort.*; *R. ericoides*, *Zucc.*, *Widdringtonia ericoides*, *Knight*; *Chamæcyparis squarrosa*, *Sieb. et Zucc.*; *Cupressus squarrosa*, *Laws.*

8. *R. PSEUDO-SQUARROSA*, *Carr. Traité*, ed. 2, p. 140; *R. squarrosa, hort., non Sieb. et Zucc.*; *Thuya squarrosa, hort.*, a form of *T. (Chamæcyparis) sphæroidea.*

See also Meehan, in American 'Gardeners' Monthly,' May 1881, and Hochstetter, cited in 'Gardeners' Chronicle,' March 12, 1881; Hoopes, 'Book of Evergreens,' pp. 331, 359; Veitch, 'Manual of Coniferæ' (1881), p. 241.

latores in DC. *Prod.* xvi. 2, p. 481; *Miquel*; *Franchet et Savatier*; *Sieb. et Zucc.*; *Endlicher*; *Carrière*; *Antoine*.

Ad promontorium Siriki Saki vel in insula Yakuno Sima, *Wright*!; Loo-Choo, *Wright*; China, *Fortune*!; Bonin Sima, *Wright*!; *Seemann*!

J. CHINENSIS, *Linn. Mant.* p. 127; *Parlatore* in DC. *Prod.* xvi. 2, p. 487; *Sieb. et Zucc. Fl. Jap.* ii. p. 58, t. 126, 127; *Miquel*; *Endlicher*; *Franchet et Savatier*; *Carrière*; *Gordon*.

J. barbadensis et *J. virginica*, *Thunb.*

J. japonica, *hort.*, ex *Carrière*, *Traité*, ed. 2, p. 31.

Synonyma indica præterivi. "Huc probabiliter *J. procumbens*, *Sieb. Fl. Jap.* ii. p. 59, t. 157. fig. 2," *Franchet et Savatier*.

In montanis Japoniæ, *Thunberg*!, *Siebold*, *Small*; in montibus Hakone frequens, *Savatier* 1189. In Himalayæ regione temperata, Cachemir, Tibet; China, *Daniel*!, *Fortune*!; Hongkong, *Hance*!; Corea, *Siebold*.

J. DAVURICA, *Pallas*, ex *Parlatore* in DC. *Prod.* xvi. 2, p. 482, et *auct. var.*; *Schmidt*, *Reise im Amurlande und auf Sachalin*; *Maximowicz*, *Primit. Fl. Amur.* (1859), p. 260.

In Sibiria altaica; prope flum. Amur, *Maximowicz*.

J. COMMUNIS, *Linn.*, *Parlatore* in DC. *Prod.* xvi. 2, p. 479, et *auct.*; *Schmidt*, *Reise im Amurlande und auf Sachalin*; *Maximowicz*, *Primit. Fl. Amur.* p. 260.

In Europa, Sibiria, Davuria, Kamtschatka, America boreali.

CRYPTOMERIA, *Don*; *Benth. et Hook.*

C. JAPONICA, *Don* in *Trans. Linn. Soc.* xviii. 2, p. 166, t. 13. f. 1; *Brongniart*; *Sieb. et Zucc.* tab. 124, 124^b; *Endlicher*; *Miquel*; *Carrière*; *Gordon*; *Henk. et Hochst.*; *Parlatore* in DC. *Prod.* xvi. 2, p. 438; *Hook. Ic. Pl.* t. 668; *Franchet et Savatier*; *Koch*.

Cupressus japonica, *Linn. fl.* (1781); *Thunb. Fl. Jap.*; *Gærtner* ex *Parlatore*, l. c.

Taxodium japonicum, *Brongniart* in *Ann. des Sc. Nat.* sér. 1, vol. xxx. p. 183.

Var. *ELEGANS* = *C. elegans*, *Veitch* in *Gordon*, *Pinet.* ed. 2, p. 73; *Siebold*.

In montanis vastas silvas efformans, *Siebold*; Kioussiou circa Nangasaki, *Kämpfer*!, *Thunberg*!; Nippon, *Perfetti*; Simoda, *Will. et Morr.*; Yokohama et Yokoska, *Savatier*; Yesso

circa Hakodate, *Maximowicz omnes ex Franchet et Savatier, Albrecht!*, *Siebold*. In Chinæ montibus prov. Che Kiang, *Fortune*; Shanghai, *Fortune!*; Chusan, *Home*; Amoy, *Swinhoe!*; Yunan, *Anderson!*

Numerous forms and varieties of this are cultivated in Japan and in this country, such as vars. *Lobbi*, *nana*, or *pygmæa*, *dacrydioides*, *araucarioides*, *pungens*, *macrocephala*, *spiralis*, *variegata*, and *viridis*. Descriptions of most of these will be found in M. Carrière's 'Traité Général,' ed. 2 (1867), p. 192 *et seq.*, and in Gordon's 'Pine-tum.' In addition, there are specimens in the herbaria, and also in gardens, of a curiously twisted form called var. *torta* by Maximowicz. With reference to the variety known as *elegans*, Gordon, as we have seen, considers it a distinct species, probably on account of its cones, which he describes as similar to those of *C. japonica*; but the scales are, in general, longer and much thinner. The plant as cultivated, with its more spreading and less "decurrent" leaves, which assume a bronzy colour in autumn and winter, suggests the notion that it is an immature, or, as M. Carrière calls it, "larval" form of *C. japonica*, analogous to those so commonly found in certain forms of *Thuya* &c. In English-grown cones I have not noted the distinguishing characters pointed out by Mr. Gordon. *C. japonica* is described as the largest tree in Japan.

TAXODIUM, *Endl.*; *Benth. et Hook.*

T. HETEROPHYLLUM, *Brongniart in Ann. Sc. Nat. sér. 1, vol. xxx. p. 184.*

Thuya lineata, *Poiret, Dict. Suppl. v. p. 305.*

T. pensilis, *Staunton, Embassy, p. 436.*

Schubertia japonica, *Spach, Hist. Veg. Phan. xi. p. 352 (syn. ex Parlatore).*

Glyptostrobus heterophyllus, *Endl. ex Parlatore in DC. Prod. xvi. 2, p. 439.*

In China, *Staunton!*, *Fortune n. 46!*, *Reeves!*; secus vias prope Canton et Whampoa, *Hance!*

The curious *Taxodium sinense pendulum* = *Glyptostrobus pendulus*, *Bot. Mag. t. 5603*, is referred by Parlatore to the South-east American *T. distichum* as var. β . *microphyllum*.

Fossil plants referred to the genera *Sequoia*, *Glyptostrobus*, and *Taxodium* are found in Miocene and Eocene deposits.

CEPHALOTAXUS, *Sieb. et Zucc. ; Benth. et Hook.*

C. PEDUNCULATA, *Sieb. et Zucc. Flor. Jap. Fam. nat. ii. p. 108, et Fl. Jap. ii. t. 133 ; Parlature in DC. Prod. xvi. 2, p. 503 ; Endlicher ; Carrière ; Gordon ; Henk. et Hochst. ; Franchet et Savatier.*

Taxus Harringtonia, *Knight, Synops. Conif. p. 51 ; Forbes, Pinet. Woburn. 217, t. 66 ; Loudon.*

Taxus Inukaja, *Knight, Synops. Conif. p. 51.*

In Japonia, *Kämpfer !* ; in regionibus montanis Kioussiou, prope Nangasaki, *Oldham !* ; in montibus Kamagona, *Veitch !* ; Nippon, in provincia Nambu, *Siebold ; Tschonoski ; Yokoska, Savatier ex Franch. et Savat. ubique culta. In China, Chusan, Fortune, ♂ !*

Var. FASTIGIATA, *Carrière, Traité Conif. ed. 2, p. 717 ; et Rev. Hort. 1863, p. 349.*

Podocarpus koraiana, *hort.*

Var. BUERGERI, *Maximowicz, Mél. Biol. vii. p. 563.*

Cephalotaxus Buergeri, *Miquel, Prolusio Flor. Jap. p. 333. Japan, Buerger !*

C. DRUPACEA, *Sieb. et Zucc. Flor. Jap. ii. p. 66, t. 130, 131, ined. ; Parlature in DC. Prod. xvi. 2, p. 504 ; Endlicher ; Carrière ; Gordon ; Henk. et Hochst. ; Miquel ; Franchet et Savatier.*

Taxus baccata, *Thunb. Fl. Jap. p. 275, fide Parlature.*

Cephalotaxus coriacea, *hort., fide Carrière.*

In Japonia circa Nangasaki, *Siebold !, Oldham !, Maximowicz ;* in montibus Kamagona, *Veitch !* ; in insula Tsusima, *Wilford ;* Nippon in provincia Nambu, *Tschonoski ;* circa Yokoska, *Savatier ;* Kunagawa, *Fortune !*

Some writers, as Koch, refer the Chinese *C. Fortunei*, Hook., to this species.

C. UMBRACULIFERA, *Sieb. MSS. in Endl. Syn. Conif. p. 239, ex Parlature in DC. Prod. xvi. 2, p. 504 ; Carrière ; Gordon ; Henk. et Hochst.*

In Japonia, *Siebold.*

A doubtful species. Gordon (ed. 2, p. 70) cites Fortune's *Torreya grandis* as identical.

TAXUS, *Linn. ; Benth. et Hook.*

T. OUSPIDATA, *Sieb. et Zucc. Fl. Jap. t. 108, ex Parlature in DC.*

Prod. xvi. 2, p. 502; *Miquel*; *Endlicher*; *Carrière*; *Gordon*; *Koch*; *Franchet et Savatier*.

In Manshuria austro-orientali, *Maximowicz*!; ad promontorium Siriki-Saki vel in insula Yakuno-sima, *O. Wright*; *Yokohama*, *Maximowicz*!; *Yesso*, *Albrecht*!, *Siebold*!, *Buerger*!

Carrière refers this in his last edition to *T. baccata*.

T. TARDIVA, *Laws.*, *ex Henk. et Hochst.* p. 361; *Parlatore in DC. Prod.* xvi. 2, p. 502.

In Japonia, *Siebold*.

A doubtful species, supposed to be a variety of the preceding. *Parlatore* refers the *T. adpressa* of gardens to this species.

T. BACCATA, *Linn.*, *Parlatore in DC. Prod.* xvi. 2, p. 500, *et auct.*

Var. *MICROCARPA*, *Schmidt*, *Reise im Amurlande und auf Sachalin*.

TORBEYA, *Arnott*; *Benth. et Hook.*

T. NUCIFERA, *Sieb. et Zucc. Fl. Jap.* ii. t. 129; *Parlatore in DC. Prod.* xvi. 2, p. 505; *Endlicher*; *Carrière*; *Gordon*; *Franchet et Savatier*; *Miquel*.

Taxus nucifera, *Linn. Sp. Pl.* ed. 1, p. 1040, ed. 2, p. 1472; *Thunberg, Fl. Jap.* p. 275; *Richard, Conif.* p. 21, t. 2. f. 3.

In montibus insularum Nippon et Sikok; juxta Nangasaki, *Thunberg*, *Siebold*!; *Yokohama*, *Maximowicz*!; *Yokoska*, *Savatier*.

T. GRANDIS, *Fortune in Gord. Pinet.* 326; *Parlatore in DC. Prod.* xvi. 2, p. 505.

In Chinæ borealis montibus Che-Kiang, *Fortune*!

GINKGO, *Linn.*; *Benth. et Hook.*

G. BILOBA, *Linn. Mant.* ii. pp. 313, 314; *Parlatore in DC. Prod.* xvi. 2, p. 507; *Thunb. Fl. Jap.* p. 358; *Sieb. et Zucc. Fl. Jap.* ii. p. 109, t. 136; *Franchet et Savatier*.

Salisburia adiantifolia, *Smith in Linn. Trans.* iii. p. 330; *Bunge, Enum. Pl. Chin. bor.*; *Loudon*; *Lindley*; *Gordon*; *Endlicher*; *Carrière*; *Miquel*.

Only known as a cultivated plant in China and in Japan.

Yunan, *Anderson*!; in Japonia, *Thunberg*!; *Nangasaki*, *Maximowicz*!, *Oldham*!

Although this is now an isolated type among Conifers, yet it has numerous allies among fossil plants. Prof. Heer (*Engler's*

Jahrbücher, 1880) traces the genus back to the Carboniferous epoch, and thence through the Secondary and Tertiary periods. He considers it the type of a section *Salisburyæ*, comprising eight genera and sixty-one species!, which were generally dispersed in the temperate and arctic zones of the northern hemisphere.

The drupe-like fruit, both in external appearance and in internal structure, resembles closely that of *Cycas*. The perisperm is covered with a brown membrane, the lower half of which is adherent to the shell. The cotyledons are two in number, retained within the seed, thick, oblong, appressed, and shortly petioled; the radicle is superior, short; the plumule, which ascends between the stalks of the cotyledons, is triangular, and the first leaves are arranged on the $\frac{1}{3}$ plan in all the specimens of germinating plants that I have examined; but as the leaves on the growing shoots are mostly distichous, these specimens were probably exceptional. A note of M. Gay's in the Kew herbarium states that in the contracted flowering shoots the arrangement of the scales and leaves is on the $\frac{5}{13}$ plan.

PODOCARPUS, *L'Hérit.*; *H. B. K.*; *Parlatore*; *Benth.*
et Hook.

P. NAGEIA, *R. Br.*, ex *Parlatore* in *DC. Prod.* xvi. 2, p. 508; *Sieb. et Zucc. Fl. Jap.* ii. p. 71, t. 135; *Maximowicz, Mél. Biol.* vii. p. 562; *Miquel*.

In Japoniæ montibus, *Kämpfer*, *Thunberg*, *Siebold*; Nangasaki, *Maximowicz!*, *Oldham!*; Yokoska, *Savatier*.

Var. ROTUNDIFOLIA, *Maximowicz* in *Regel, Garten Flora*, 1864, p. 37; *P. ovata*, *Henk. et Hochst.* p. 381, fide *Maximowicz*; *Franchet et Savatier*.

Var. ANGUSTIFOLIA, *Maximowicz, l. c.*; *Franchet et Savatier*.
In Japonia, *Siebold!*, *Oldham!*

P. CÆSIA, *Maximowicz, Mél. Biol.* vii. p. 561; *Franchet et Savatier*.

In urbe Nangasaki rarius culta. E Japonia meridionali ortam suspicatur cl. auctor.

P. APPRESSA, *Maximowicz, loc. cit.*

In urbe Yeddo rarius culta.

P. MACROPHYLLA, *Don in Lambert, Pinus*, ed. 2, p. 123, et

ed. 3, n. 75; *Parlatore in DC. Prod.* xvi. 2, p. 517; *Sieb. et Zucc. Fl. Jap.* t. 133; *Endlicher*; *Carrière*; *Gordon*; *Miquel*; *Henk. et Hochst.*; *Maximowicz.*

Taxus macrophylla, *Thunb. Fl. Jap.* p. 276.

In collibus inter frutices. Kioussiou circa Nangasaki, *Thunberg*!; ad Yokoska, *Savatier*, *Oldham*!; Yunan, *Anderson*!

P. OHINENSIS, *Wall. Cat.* 6051, *ex Parlatore in DC. Prod.* xvi. 2, p. 516; *Endlicher*; *Carrière*; *Gordon.*

P. Maki, *Sieb. et Zucc.* t. 134, *ex Parlatore, l. c.* p. 516.

"In China et probabilitur in Japonia ubi in hortis culta," *Siebold*!, *Macartney*!; Mt. Loo Choo, *Shearer*!

Species non satis cognitæ e Japonia in hortis Europæis introductæ.

P. CUSPIDATA, *Endl., ex Parlatore in DC. Prod.* xvi. 2, p. 509.

P. GRANDIFOLIA, *Endl., ex Parlatore, l. c.* p. 509.

P. JAPONICA, *hort. Bogor., ex Parlatore, l. c.* p. 518.

Podocarpus occurs in strata of Miocene and Eocene age.

CUNNINGHAMIA, *R. Br.*; *Benth. et Hook.*

C. SINENSIS, *R. Br. in Rich. Conif.* p. 80, t. 18. f. 3; *Parlatore in DC. Prod.* xvi. 2, p. 432; *Loudon*; *Sieb. et Zucc. Fl. Jap.* ii. p. 7; t. 103; *Forbes in Pinetum Woburnense*, tab. 57; *Endlicher*; *Carrière*; *Gordon*; *Miquel*; *Murray.*

Pinus lanceolata, *Lamb. Pin.* ed. 1, vol. i. p. 52, t. 34.

Cunninghamia lanceolata, *Lamb. Pin.* ed. 2, p. 59, t. 37, et ed. 3, p. 96, t. 53; *Hook. Bot. Mag.* t. 2743.

Belis jaculifolia, *Salisb. in Linn. Trans.* viii. p. 315; *B. lanceolata*, *Sweet, Hort. Brit.* p. 475.

In China australiore, *Bradley*!; *Staunton*!; *Fortune*! In Japonia culta, Yokohama, *Maximowicz*!

The fossil representative of this, *Cunninghamites*, has been found in the Keuper and Chalk deposits.

SCIADOPITYS, *Sieb. et Zucc.*; *Benth. et Hook.*

S. VERTICILLATA, *Sieb. et Zucc. Fl. Jap.* ii. p. 1, tabb. 101, 102; *Miquel*; *Endlicher*; *Carrière*; *Gordon*; *Murray, Pines and Firs of Japan* (1863), p. 109, fig.; *Henk. et Hochst.*; *Parlatore in DC. Prod.* xvi. 2 (1868), p. 435; *Koch*; *Franchet et Savatier*; *Lindley in Gard. Chron.* 1861, pp. 22, 360 (fig.); *Dickson in Report Bot. Congress London*, 1866, p. 124.

Taxus verticillata, *Thunb. Fl. Jap.* p. 276, excl. syn.; *Kæmpfer, Amœn.* ex. p. 883, icon. cccviii.

Pinus verticillata, *Sieb., ex Parlatore, l. c.*

Var. VARIEGATA, *Gordon, Pinetum*, ed. 2, p. 377.

In Japonia, *Thunberg!*, *Kæmpfer!*; in regione orientali insulæ Nippon; in monte Kojasan provinciæ Kii, *Siebold!*; in collibus prope Konagawa, *Oldham!*; juxta Nangasaki, *Mohnike!*; Yokohama, *Maximowicz!*; Yokoska, *Savatier!*; sæpe plantata et tunc in multis locis an revera sit spontanea dubitatur (*Franchet et Savatier*), *Maximowicz!*, *Oldham!*

The fact that this fine tree is so often met with planted in the enclosures around the temples has given rise to the surmise that it may have been introduced by the Buddhists; but the tree is not known in any other country than Japan. Numerous varieties exist in Japanese gardens.

The so-called leaves of this plant are phylloid shoots, as pointed out by Dr. Alexander Dickson in the Report of the London Botanical Congress of 1866. Confirmation of this view is afforded by the subdivision of the leaf-like organs, and the existence in the fork so formed of a little axis bearing at its summit a verticil of pseudo-leaves*. The seedlings have two linear cotyledons.

PINUS, *Linn. pro parte; Benth. et Hook.*

P. DENSIFLORA, *Sieb. et Zucc. Fl. Jap.* ii. p. 22, t. 112!; *Endlicher!*; *Carrière!*; *Murray!*; *Henk. et Hochst.!*; *Parlature in DC. Prod.* xvi. 2, p. 388; *Gordon, Pinetum*, ed. 2, p. 233; *Engelmann, Revision of the Genus Pinus* (1880), p. 16, adnot. 10.

P. japonica?, *Antoine, Conif.* p. 23.

P. pinea, *Gord. Pinet.* ed. 1, p. 179, ex parte.

P. Massoniana, *hort. aliq.*

Per totam Japoniam, *Siebold!*, *Maximowicz!*, *Veitch!*, *Oldham!*, *Wright!*, *Maries!*; Korea, *Oldham!*; in China boreali, *Daniel!*

Engelmann (l. c.) places this in his § 4. *Sylvestres*, a group characterized, *inter alia*, by its peripheral ducts. In the type specimens of *Siebold* in the Kew herbarium, however, I find the resin-canals variable, the larger ones often parenchymatous.

* *Masters*, 'Vegetable Teratology,' p. 523, adnot.; *Carrière*, in 'Revue Horticole,' 168, p. 150, cum ic.

P. THUNBERGII, *Parlatore in DC. Prod.* xvi. sect. post. p. 388 (1868); *Engelmann, Revision*, p. 22, adnot. n. 26.

P. silvestris, *Thunb. Fl. Jap.* p. 274, non *Linn.*

P. Pinaster, *Loud. Arboret.* 2218; *Gordon, Pinet.* p. 176, ed. 1, non *Soland.*

P. rubra, *Siebold in Verhand. van het Batav. Genootsch.* vol. xii., ex *Endlicher.*

P. Massoniana, *Sieb. et Zucc. Fl. Jap.* ii. p. 24, t. 113, 114; *Endlicher*; *Carrière*; *Murray*; *Henk. et Hochst.*, non *Lambert.*

Per totam Japoniam, *Oldham* 561!; in China, *Maximowicz*!; Korea, *Oldham*!

This is included in Engelmann's group 6. *Ponderosæ*, to which parenchymatous ducts are assigned. Cultivated specimens in the Kew arboretum show this arrangement, and are, moreover, remarkable for their large ovoid acuminate buds covered with dense white silky hairs.

P. PARVIFLORA, *Sieb. et Zucc. Fl. Jap.* ii. p. 27, t. 115 (1842); *Endlicher*; *Carrière*; *Gordon*; *Murray*; *Henk. et Hochst.*; *Parlatore in DC. Prod.* xvi. 2, p. 404; *Syme in Gard. Chron.* November 16, 1878, p. 624, fig. 103; *Engelmann, Revision*, p. 15, adnot. 2.

P. Cembra, *Thunb. Fl. Jap.* p. 274, non *Linn.*

In Japoniæ provinciis borealibus in insulas Kurilas usque procedens; in ins. Yesso, *Maries*!; *Oldham* 518, 807 et 808!; *Siebold*!; *Yokohama, Maximowicz*!; in ins. *Nutka*?

Engelmann includes this in his sect. 1. *Strobilus*, with ducts peripheral, not surrounded by strengthening cells; and my observation of the leaves of Siebold's type specimen agrees with that of Engelmann. *P. heterophylla*, Presl in herb. Hænke, is referred to this species by Engelmann. If correctly so, the identification is the more important as it extends the distribution of the species to *Nutka* island.

P. KORAIENSIS, *Sieb. et Zucc. Fl. Jap.* ii. p. 28, t. 116 (1842); *Endlicher*; *Carrière*; *Gordon*; *Murray*; *Henk. et Hochst.*; *Koch*; *Parlatore*; *Engelmann, Revision*, p. 16.

P. Strobilus, *Thunb. Fl. Jap.* p. 275 (1784), nec *Linn.*

In Koraia, in Kamtschatka et in insula Koraginsk teste *Siebold*; in montibus Fakoniæ. Colitur in Japonia, *Tschonoski*!; *Maries*!; *Veitch*! In Manchuria ad fl. Ussur, *Maach*!

Engelmann places this in his § 2. *Cembra*, marked, among

other things, by parenchymatous ducts. In Siebold's type specimens such an arrangement is seen. The leaves have few or no hypoderm- or strengthening-cells, and the central woody bundle is inversely heart-shaped on transverse section, the point being upwards. This corresponds with the three-sided form of the leaf.

P. CEMBRA, *Linn. Sp. Pl.* 1000, *et auct.*; *Parlatore in DC. Prod.* xvi. 2, p. 403 (1868); *Engelmann, Revision*, p. 16, adnot. 4.

In toto Alpium jugo, in Carpatis valles, in Rossia boreali; per omnem Sibiriam borealem et alpinam frequens.

Var. β . *PUMILA*, *Parlatore, l. c.*; *Maximowicz, Primit. Fl. Amur.* p. 260 (1859).

P. mandshurica, *Rupr. ex Regel, Tent. Fl. Ussur.* p. 149; *Murray in Pinet. Brit.* part 17; *Maximowicz, l. c.*

In Davuria, Sibiria orientali, Kamtschatka, insulis Kurilibus, et in America arctica ad sinum Kotzebue, in ins. Sachalin, *Schmidt!*

P. SILVESTRIS, *Linn. Sp. Pl.* 1000, ed. 2, 1418, *et auct.*; *Parlatore in DC. Prod.* xvi. 2, p. 385 (1868), c. synonym. et varr. plurim.; *Engelmann, Revision*, p. 16, adnot. 8.

In Europa arctica, boreali et media; in Asia arctica et boreali-orientali; in Sibiria omni a montibus Uralensibus ad Altaicos, in Sibiria orientali et in Davuria et prope fl. Amur, Caucasus, Asia Minor, Persia.

P. MASSONIANA, *Lambert, Pinet.* ed. 1, t. 12 (1803), ed. 2, p. 16, t. 8, et edit. 3, p. 20, t. 8, non aliorum; *Parlatore in DC. Prod.* xvi. 2, p. 389 (1868); *Engelmann, Revision*, p. 16, adnot. 11.

? *P. silvestris*, *Loureiro, non Linn., ex Parlatore, l. c.*

P. sinensis, *Lamb. Pinet.* ed. 3, p. 47, t. 29; *Antoine*; *Endlicher*, excl. syn.; *Carrière*, excl. syn.; *Gordon*, quoad plant. Sinens. et excl. syn.

Hongkong, *Champion!*, *Hinds!*; China, *Macartney!*, *Reeves!*, *Seemann!*; Formosa, *Oldham 554!*

Engelmann points out the distinctive characters of this Chinese species, and even refers Griffith's 4992, from Afghanistan, to this species with some hesitancy. The resin-canals in a leaf of the type specimen are numerous, parenchymatous, and surrounded by strengthening-cells.

P. BUNGEANA, *Zuccarini in Endl. Conif.* p. 166; *Parlatore in DC. Prod.* xvi. 2, p. 398 (1868); *Engelmann, Revision*, p. 16.

In China boreali (*Bunge*); *Bushell!*; *Fortune!*

This is included by Engelmann in his § 5. *Halepenses* with peripheral ducts. I find the leaves three-sided in section, with a double layer of hypoderm and four peripheral resin-canals surrounded by strengthening-cells.

P. KHASIA, *Royle, ex Parlatore in DC. Prod.* xvi. 2, p. 390, c. syn.

Yunan, *Anderson, ex Kurz in Trimen's Journal of Botany*, 1873, p. 193.

Nepal, Khasia.

This belongs to the East-Himalayan flora rather than to the Chino-Japanese; but its presence in Yunan affords an interesting example of the gradual commingling of two floras.

The fossil representatives of this genus (= *Pinites*) occur in deposits of all ages, from the Miocene to the Coal-formation.

PICEA, *Link (haud Don); Benth. et Hook.*

P. OBOVATA, *Ledebour, Fl. Altaica*, iv. p. 201, *Ill. t.* 499; *Link; Carrière (ex Parlatore); Regel, Fl. Ussur.* p. 149 (1862); *Maximowicz, Primit. Fl. Amur.* (1859), p. 260.

Abies obovata, Loudon, Arbor. Brit. iv. p. 2329; *Gordon; Henk. et Hochst.*

Pinus obovata, Antoine, Conif. p. 96, t. 37. f. 2; *Endlicher; Parlatore in DC. Prod.* xvi. 2, p. 415 (1868).

P. *Abies, Pallas, fide Parlatore.*

In Europa boreali-orientali et in Asia boreali in insulis Kurilis, *Pallas*; Manchuria prope fl. Amur, *Maximowicz* 576!; Ireutia, *Turczaninow!*; prope fl. Ussur, *Maack!*

Resin-canals two or none.

Var. β . SCHRENKIANA, foliis longioribus.

Picea Schrenkiana, Fisch. et Mey. in Bull. Acad. Pét. x. p. 253; *Carrière.*

Picea Schrenkiana, Antoine, Conif. 97; *Endlicher.*

Abies Schrenkiana, Lindl. et Gord. Journ. Hort. Soc. Lond. v. p. 212.

Pinus orientalis β . longifolia, *Ledeb. Flor. Ross.* iii. p. 671, *fide Parlatore.*

Pinus obovata, var. β . Schrenkiana, Parlatore in DC. Prod. xvi. 2, p. 415 (1868).

Dr. M. Masters.

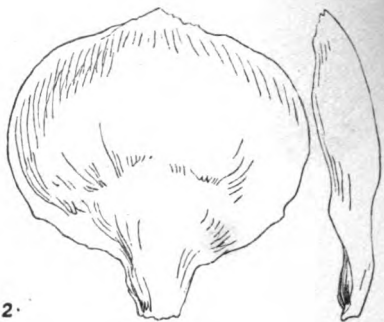

Branch with cones, real size; portion of shoot, showing the pulvini, magnified
section of la

PIC 1

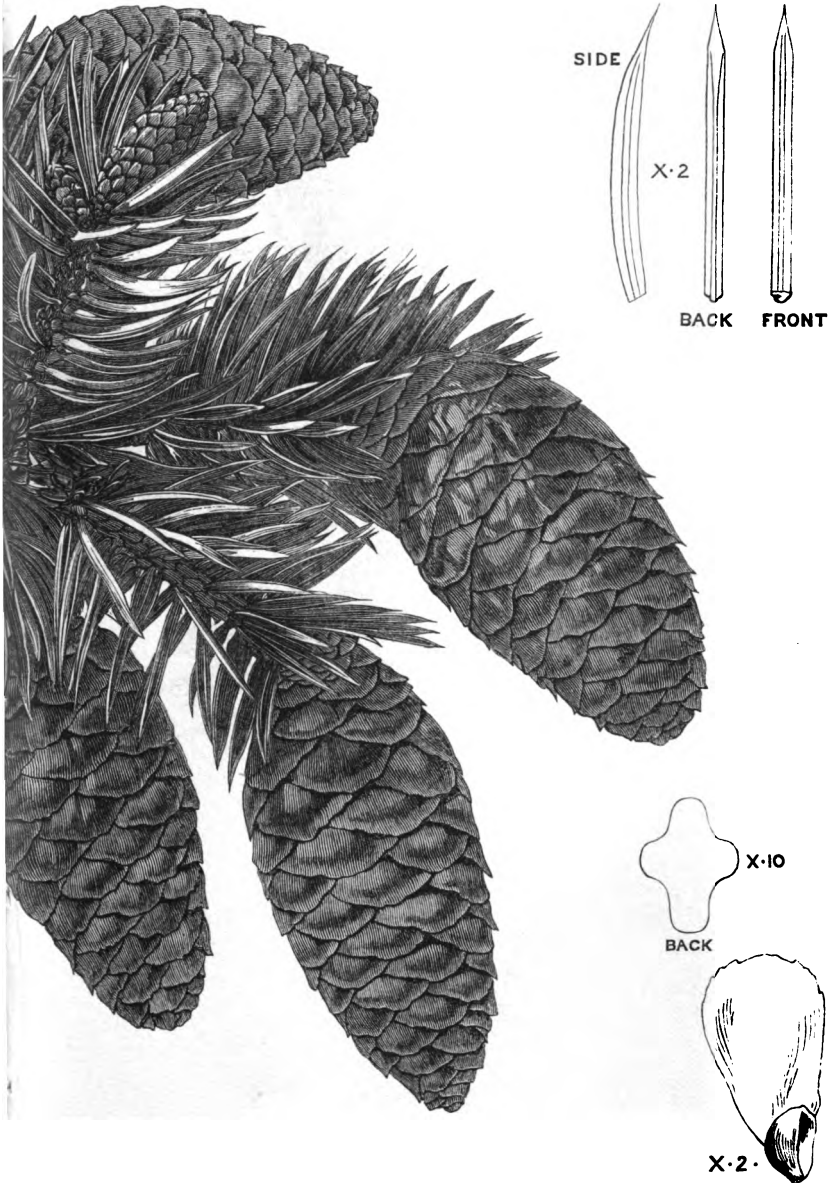

POLITA.

leaves, cone-scales, and seeds from a cultivated specimen, all magnified twice;

In Songaria, *Schrenk!*; in montibus Alatau, in Sibiria altaica deserto Songoro-Kirghisico.

P. MAXIMOWICZII, *Regel, Ind. Seminum, Hort. Petrop.* 1865 (nomen tantum); *Carrière; Mast. in Gard. Chron.* vol. xiii. 1880, p. 363.

Abies Maximowiczii, *Rob. Neumann, Cat., ex Parlatore in DC. Prod.* xvi. 2, p. 431 (nomen); *Gordon.*

A. obovata, var *japonica*, *Maximowicz, Ind. Sem. Hort. Petrop.* 1866, p. 5, *ex Franchet et Savatier, Enum. Pl. Jap.* i. p. 466.

In Japonia, *Tschonoski!*

This is a species concerning which little is at present known. As seen in English gardens, it is a dwarf, compact Spruce-Fir with glabrous brown shoots, and needle-shaped, 4-sided, spine-tipped leaves spreading on all sides, almost at right angles to the stem. It differs from all other Spruces known to me in the presence of a single resin-canal beneath the midrib, as in the Hemlock-Spruces (*Tsuga*), but which is sometimes absent. It seems allied to *obovata*, differing in its small stature and in the peculiar position of the resin-canal. It may be an immature or transitory form of some other species.

Fig. 6.

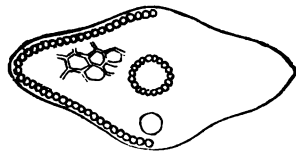

Transverse section of the leaf of *Picea Maximowiczii*; magnified plan.

P. TIANSCHANICA, *Ruprecht, Sertum Tianschanicum*, p. 72.

Aff. *P. Schrenkianæ*.

Tian Schan.

I only know this species by name; and, indeed, it is, geographically speaking, out of the district to which this paper refers.

P. POLITA, *Carrière, Traité Gén. des Conifères* p. 256, ed. 2, p. 342 (1867); *Mast. in Gard. Chron.* Feb. 21, 1880, p. 233. (See Plate XIX.).

Abies polita, *Sieb. et Zucc. Flor. Jap.* ii. p. 20, t. iii.; *Lindley; Gordon; Murray; Veitch, in Gard. Chron.* 1862, p. 308.

Pinus polita, *Antoine, Conif.* p. 95, t. 36. f. 1; *Parlature in DC. Prod.* xvi. 2, p. 417 (1868).

In montibus ins. Nippon, *Veitch!*, *Maximowicz!*, *Maries!*; Korea.

The resin-canals are two to each leaf, peripheral.

P. ALCOCKIANA, *Carrière, Conif. ed. 2, p. 343; Mast. in Gard. Chron. Feb. 14, 1880, p. 212, c. ic.* (See figs. 7, 8, 9.)

Abies Alcoquiana, *J. G. Veitch, in Gard. Chron. 1861, p. 23, et 1862, p. 308; Gordon; Murray, pro parte.*

Pinus Alcoquiana, *Parlatore in DC. Prod. xvi. 2, p. 417 (1868).*

Abies bicolor, *Maximowicz, Mél. Biolog. t. 6 (1866), p. 24, in Bull. Acad. Imp. Sc. St. Pétersb. t. x.*

Nomina hortensia: *Abies excelsa*, var. *acicularis*; *A. obovata*, var. *japonica*, *Hort. Petrop.*

Hab. Mongolia, ad fluv. Amur et Ussur, *Maximowicz!*; in ins. Sachalin, *Glehn!*; in ins. Nippon montibus, *Veitch!*, *Maximowicz!*, *Oldham!*, *Maries!*

Nearly allied to *P. obovata*. The resin-canals (fig. 7) are sub-epidermal.

Fig. 7.

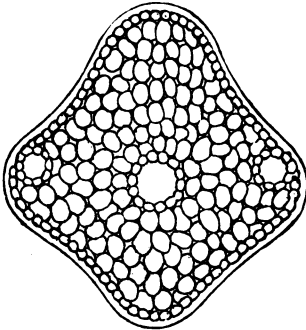

Plan of transverse section of leaf of *Picea Alcockiana*, magnified.

Fig. 8.



Scales and seeds from the type specimen of *P. Alcockiana*.

P. AJANENSIS, *Fischer, Florul. Ochotensis, Trautvett. et Meyer, Fl. Ochot. in Middendorff, Reise, p. 87, t. 22-24 (1856); Regel, Fl. Ussur. p. 149; Maximowicz; Carrière; Mast. in Gard. Chron. Jan. 24, 1880, p. 115, et Oct. 2, 1880, p. 427, c. ic.*

Abies ajanensis, *Lindl. et Gordon, Journ. Hort. Soc. Lond. v. p. 212.*

Pinus Menziesii, *Parlatore in DC. Prod. xvi. 2, p. 418 (1868), quoad plantam Asiaticam (synonymis exclusis).*

Abies Alcoquiana, hort plurim., *Murray, Pines and Firs of Japan, p. 66, quoad folia; J. G. Veitch, in Gard. Chron. 1861, p. 23, specimina autem typica in Museo Veitchiano cum descriptione haud congrunt.*

Fig. 9.

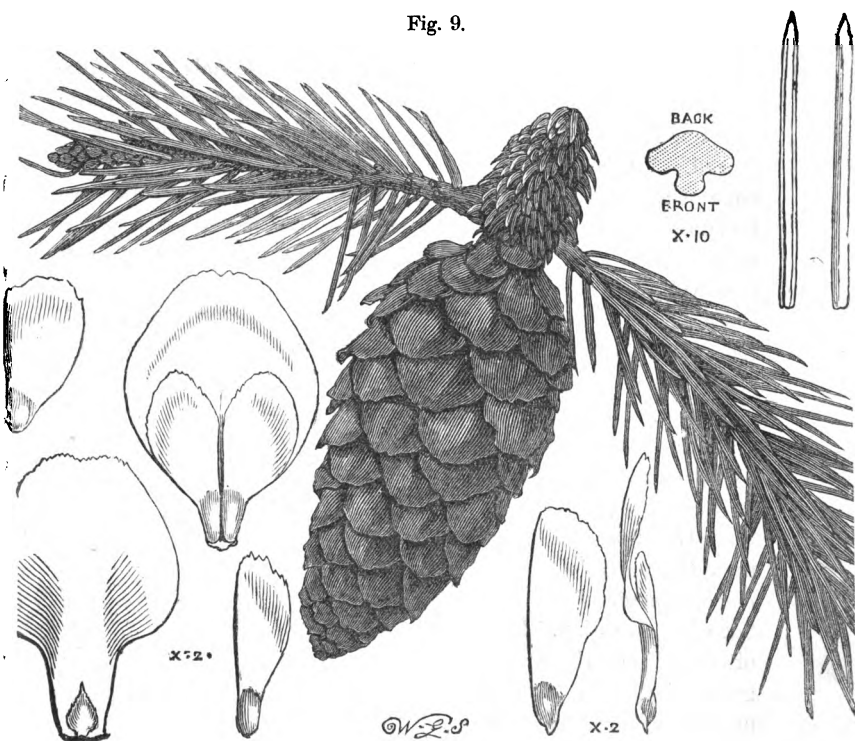

Picea Alcockiana (cultivated specimen). Cones, leaves, scales, and seeds: enlarged.

Abies sitchensis, Koch, *Dendrologie*, ii. pl. 2 (1873), p. 247, haud Bongard.

Picea jezoensis, Maximowicz, in *Bull. Acad. Imp. Sc. St. Pétersb.* xv. p. 235.

Hab. in Mongolia prope flumen Amur, Maximowicz!; in ins. Yesso ad Sapporo, Maries, n. 74!

Var. *MICROSPERMA*, Mast. loc. *suprà cit.*

? *Abies jezoensis*, Siebold et Zucc. *Flor. Japon.* ii. p. 19, t. 110.

Abies microsperma, Lindl. in *Gard. Chron.* 1861, p. 22; Veitch, in *Gard. Chron.* 1862, April 5, p. 308; Murray.

Picea ajanensis, var. *japonica*, Maximowicz, iter secund.

Hab. in ins. Yesso, Veitch!; Maximowicz!; Maries!; Oldham 814! 979!

This Spruce has been confounded with the *P. sitkensis* or

Menziesii of North-west America, from which it differs in its flatter, less deeply keeled, and blunter leaves. In the American species, moreover, there are usually no resin-canals. In cultivation the habit and general aspect of the two trees are different; but upon this point very little, if indeed any, reliance can be placed. Dr. Engelmann states (*in litt.*) that he has examined a cone of the typical *P. sitkensis*, in which he found the bracts to be lanceolate, remarkably large, half as long as the scarcely undulate scale, while in *P. ajanensis* the bracts are minute, short and oval, and the scales are undulate. Maximowicz also describes the bracts of *P. ajanensis* as minute, suborbicular (Primit. Fl. Amur.). Maximowicz further indicates two varieties of *P. ajanensis*—var. *a. genuina*, with cone-scales markedly denticulate; the other, var. *β*, with cone-scales subentire.

With reference to the position of the resin-canals, they *appear* to be on the *upper* surface of the leaves, and therefore different in that respect from the leaves of many other Conifers. In describing the species in the 'Gardeners' Chronicle,' as also in the mention made of it in the 'Journal' of this Society, vol. xvii. p. 549, I fell into the error of describing the upper surface as dark green, the lower surface as glaucous. This is, indeed, *apparently* true of the lateral shoots; but the *real* disposition is exactly the reverse. In order to avoid further confusion, I would here call attention to the leaves on the erect leader-shoots and to those on the side-branches respectively. On the erect shoots the leaves are not twisted at the base, but are erect and appressed to the stem, the glaucous surface being next the axis, somewhat concave and abundantly provided with stomata; the midrib is continued throughout the whole length of this surface, and may be excurrent into a "mucro" (fig. 11). The green convex surface is external, marked with three ridges, and in the furrows between the central larger and the lateral smaller ridges are placed the resin-canals. It terminates in a flat rhomboidal

Fig. 10.

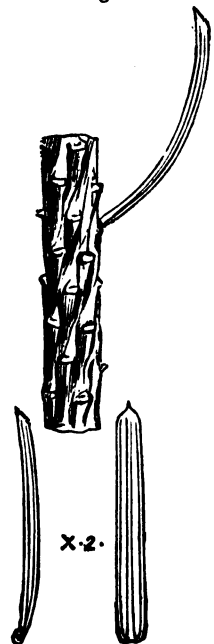

Portion of shoot and
leaves of
Picea ajanensis.

surface, into which the midrib is not prolonged (figs. 10, 12). On the horizontal side-shoots the leaves are spreading and more or less twisted at the base, so that the green surface is now uppermost, the glaucous surface beneath, whence arises the apparent

Fig. 11.

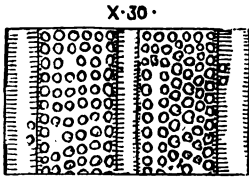

Apparent under, real upper, surface of the leaf of *Picea ajanensis* from horizontal branch.

Fig. 12.

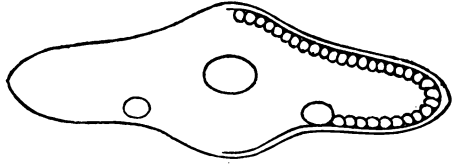

Diagrammatic section of leaf of *P. ajanensis*, in its real position.

position of the resin-canals on the upper (really lower) surface of the leaf. It may be further noted that on the side-shoots, while the leaves on the underside of the branch spread away more or less horizontally and are twisted, those on the upperside of the branch are placed parallel to the long axis of the branch and are not twisted. Their position therefore is exactly the same as that of the leaves on the leader-shoot. The resin-canals are in contact with the palissade-cells, and are nearest to the green surface of the leaves. It is the green surface which is ordinarily most exposed to the light, the glaucous and specially stomatiferous surface, beneath which there are no palissade-cells, being furthest from the light. *Picea sitchensis* has the glaucous leaf-surface next the axis, as also many Junipers.

On the leader-shoot of *Abies Nordmanniana* the leaves are so twisted that the glaucous surface is away from the axis. It is probable, nay, in some cases, it is certain, that the position of the leaves varies in different stages of growth and according to different circumstances; but such a movement by torsion cannot affect the internal disposition of the anatomical elements*.

The resin-canals, when present, are placed on the side of the leaf furthest from the palissade-cells; but in *P. ajanensis* the resin-canals are in contact with them. Dr. Engelmann has pointed out to me "that in all the Abietinæ, probably in all the Coniferæ, the vascular bundle consists of an upper layer of wood-

* Masters, "Note on Morphology and Physiology of the Leaves of certain Conifers," Journ. Linn. Soc. Bot. vol. xvii. p. 547.

cells and a lower one of bast-cells. In *Piceas* (Spruces) the bast-cells and the ducts are on the same side; and the stomata in the flat-leaved Spruces (e. g. *P. ajanensis*) mostly on the opposite side." This is in accordance with the observations of Bertrand and MacNab; and I can myself abundantly confirm it even in the case of the species which has given rise to these remarks.

P. GLEHNII, *Fr. Schmidt, Reise im Amurlande und auf der Insel Sachalin*, 1866, p. 176, fig.; *Mem. Acad. Imp. Sc. St. Pétersb. sér. 7, t. xii. n. 2*; *Masters, in Gard. Chron.* 1880, March 6, p. 300, c. ic. xylogr. (See fig. 13.)

In ins. Sachalin, *Fr. Schmidt*!; in ins. Yesso, *Maries*, n. 72!; ? in Manchuria, ad flum. Ussur, *Maack*!

This species closely resembles *P. Alcockiana* or *P. obovata*, but may be distinguished from the former by the hairy branches, the less prominent pulvini, the thinner cone-scales, persistent bracts, and wider wing to the seed. From *P. obovata* it differs in the pulvini and in the shorter broader wing to the seed (*Schmidt*). The buds have a curious appearance of being embedded within the apex of the branches, owing to the abrupt passage from the thick and crowded pulvini to the thinner bud-scales. The cones are cylindric, generally about 2 inches long, but sometimes scarcely 1 inch. The leaf-structure is the same as that of *P. Alcockiana* and *P. obovata*.

Traces referred to this genus have been found in the Miocene and Cretaceous deposits.

TSUGA, *Carr. ; Benth. et Hook.*

T. SIEBOLDI, *Carr. Conif.* p. 186; ed. 2, p. 245.

Pinus Arragi, *Siebold, ex Parlatore.*

Abies Tsuga, *Sieb. et Zucc. Fl. Jap.* ii. p. 14, t. 106; *Gordon ; Henk. et Hochst. ; Murray, Pines and Firs*, p. 84; *Franchet et Savatier ; J. G. Veitch, Gard. Chron.* 1862, p. 308.

Pinus Tsuga, *Endlicher, Conif.* p. 83; *Antoine, Parlatore in DC. Prod.* xvi. 2 (1868), p. 428.

Abies araragi, *Loud.*

In Japoniæ borealis provinciis Matsu et Dewa, *Siebold ; Veitch!*; *Maximowicz!*; *Savatier.*

Var. β . NANA, *Sieb. et Zucc. l. c.*

This is the Japanese representative of the Hemlock Spruce of the American continent and of the Himalayan *T. dumosa*.

Fig. 13.

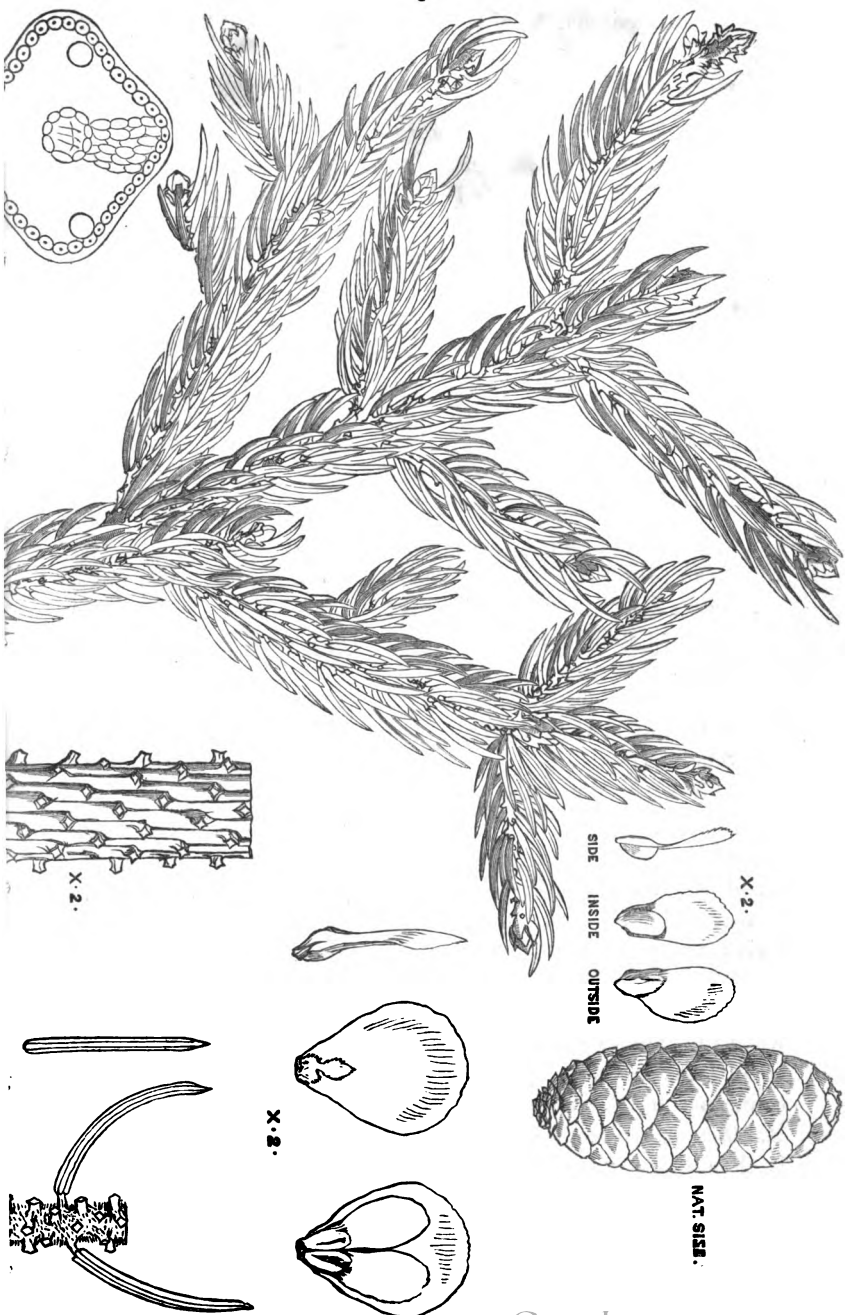

Glehnii (native specimen). Branch and cone, nat. size; shoot, detached leaves, scales, and seeds magn. twice; transverse section of leaf, highly magnified.

T. DIVERSIFOLIA.

Abies diversifolia, *Maxim. Mél. Biol.* vol. vi. p. 373; *Franchet et Savatier, Enum. Pl. Jap.*

In insulæ Nippon alpinis, in Kiousiou, *Maximowicz*.

ABIES, *Juss. pro parte; Link; Benth. et Hook.*

A. FIRMA, *Sieb. et Zucc. Flor. Jap.* ii. p. 15, t. 107 (1842)!; *Gordon; Carrière; Lindley; Veitch in Gard. Chron.* 1862, p. 309!; *Murray* (excl. syn.); *Bertrand in Ann. Sc. Nat.* (1874), p. 95, quoad foliorum structuram!; *MacNab, in Proceed. Royal Irish Acad. sér. 2,* vol. ii. (1876), p. 686, quoad folia (synon. excludend.)!; *Masters in Gardeners' Chronicle,* vol. xii. pp. 198, 199 (1879).

Abies Momi, *Siebold, Koch, Dendrologie,* ii. p. 227 (1873).

Pinus firma, *Antoine, Conif.* p. 70, tab. 27 bis; *Endlicher, Synops.* p. 99 (1847); *Parlatore, in DC. Prod.* xvi. 2, p. 424, excl. syn.

Picea firma, *Gordon, Pinet.* p. 147, ed. 2, p. 204!, excl. syn.

Abies holophylla, *Maximowicz in Mél. Biol.* t. vi. p. 23 (1866)!

Pinus holophylla, *Parlatore in DC. Prod.* xvi. 2, p. 424 (1868).

Var. (vel potius forma juvenilis) BIFIDA.

Abies bifida, *Sieb. et Zucc. Fl. Jap.* ii. p. 18, t. 109; *Carrière; Veitch in Gard. Chron.* 1862, p. 308.

Pinus bifida, *Antoine, Conif.* p. 79, t. 31. f. 2; *Endlicher, Conif.* p. 101.

Picea Webbiana, *Gordon, Pinet.* p. 160 (1858), ex *Murray*.

In Japonia, *Kæmpfer*!; in Japoniæ insulis a Kiusiu per Sikok, Nippon, Yesso et Karafto, nec non aliquas Kurilium diffusa; in Manchuria austro-orientali, *Maximowicz*!

In the 'Gardeners' Chronicle,' above cited, I have given in detail my reasons for following the lead of those who have combined the two reputed species of *firma* and *bifida*. Briefly, it may be stated that, although the external appearance of the leaves is very different, and the internal organization, as studied by *Bertrand*, by *MacNab*, and by myself, yet more so, it is impossible to consider them as belonging to two different species, when they are seen to be borne on different branches of the same tree. This was seen by *Mr. J. G. Veitch*; and his testimony is confirmed by the specimens brought home by *Mr. Maries*. *A. bifida* has, moreover, never been seen bearing cones. There is, then, every reason to assert that the *bifida* form is simply the juvenile immature and sterile form of the same tree, which in the mature state we know as *A. firma*.

Dr. M. Masters.

Fig. 2.



X·2



X·2



Fig. 4.



Fig. 1. Branch with cones, nat. size.

Fig. 2. Bract, scales, and seeds.

Fig. 3. Transv

ABIES VE

Fig. 1.



Fig. 3.

X-10

II.
tion of leaf-plan.

Fig. 4. Anthers seen from the back, front, and side, magnified.

As to Maximowicz's *A. holophylla*, the only important difference between it and the typical *firma* resides in the fact that in the latter the bracts always project beyond the scales, while in *holophylla*, they are much shorter than the scales and concealed by them. But among Mr. Maries' cones (gathered, as I am informed, by himself, from trees of indubitable *firma*) some are quite indistinguishable from the typical cones of *holophylla* in the Kew Museum. Such variations in the relative length of the scales and bracts are not uncommon in Conifers. The difference in the leaves (those of *holophylla* entire and mucronate, those of *firma* obtuse emarginate, or acute and bifid) is even less important as a character.

Fig. 14.

Small-sized native specimen of cone of *Abies brachyphylla*.

A. BRACHYPHYLLA, Maximowicz, *Mélanges Biolog.* t. vi. p. 23 (1866)!; *Masters in Gard. Chron.* Nov. 1, 1879, p. 556, c. ic. xylogr. (Figs. 14, 15.)

Pinus brachyphylla, Parlatores in *DC. Prod.* xvi. 2. (1868), p. 424.

P. firma, MacNab, *Proc. Roy. Irish Academy*, 1876, p. 686!; *nec Sieb. et Zucc.*

Picea brachyphylla, Gordon, *Pinetum*, ed. 2, p. 201 (1875).

Nomina hortensia: *Picea Veitchii*, *Picea firma*, *P. pinnosa*. An eadem ac *A. homolepis*, Sieb. et Zucc.?

In ins. Nippon, Maximowicz!; Maries, n. 259!

The seedling plants of this species, brought from the slopes of Fusi Yama by Mr. Maries, are not distinguishable from the *bifida* form of *A. firma*.

A. VEITCHII, Lindley in *Gard. Chron.* 1861, p. 23!; Veitch, l. c. 1862, p. 308; Murray; Carrière; Koch; Bertrand (folia tantum); Franchet et Savatier; Mast. in *Gard. Chron.* Feb. 28, 1880, p. 275, c. ic. (See Plate XX.)

Picea Veitchii, Gordon, *Pinetum*, ed. 2, p. 226 (1875).

Fig. 15.

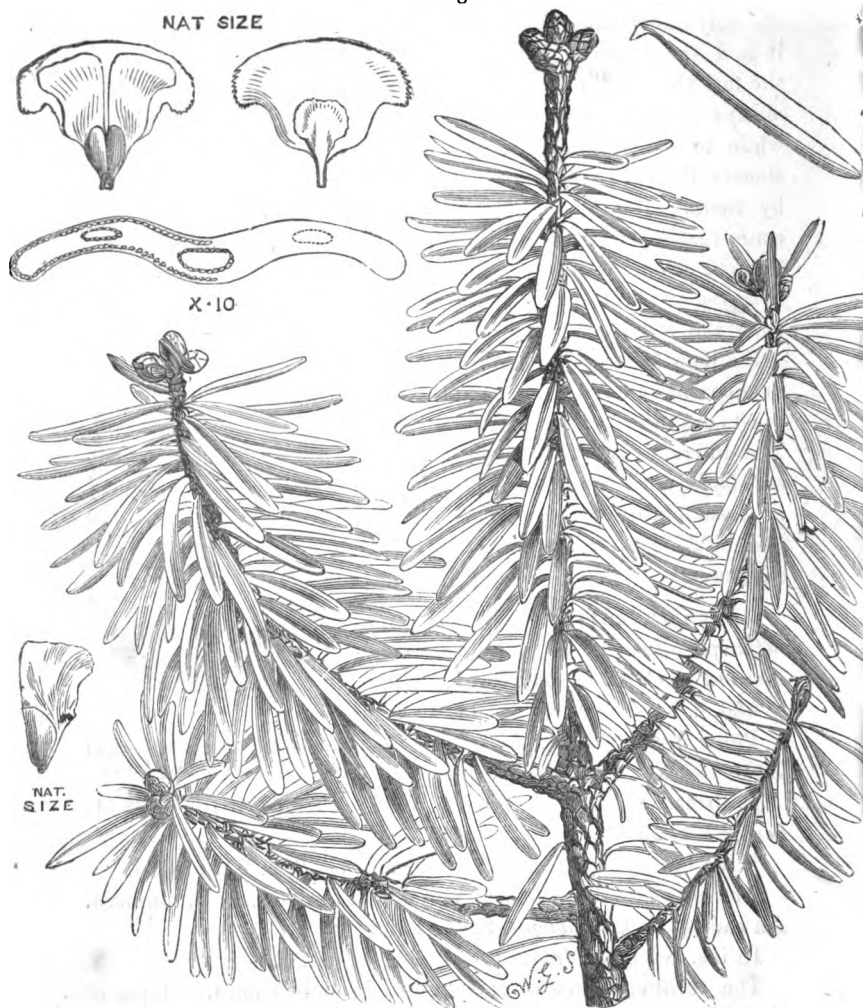

Foliage and structural details of *Abies brachyphylla* (native specimen).

Abies nephrolepis, *Maximowicz*, *Mél. Biol.* vi. p. 22 (1866)!

A. sibirica, var. *nephrolepis*, *Trautvetter ex Maximowicz*, *Primit. Flor. Amurens.* p. 260 (1859)!

Pinus selenolepis, *Parlatore in DC. Prod.* xvi. 2, p. 427 (1868).

Pinus Veitchii, *MacNab*, *Proc. R. Irish Acad.* p. 686 (1876) (foliorum anatomia).

In ins. Nippon, Fusi Yama, 6000-7000 ped., *Veitch* !, *Oldham* 813 !, *Maries* !; Hakodate (cult), *Maximowicz* !; Manchuria austro-orient., *Maximowicz* !; ? in ins. Sachalin, *Schmidt*.

A. SACHALINENSIS, *Mast. in Gard. Chron.* Nov. 8, 1879, p. 588, c. ic. (See fig. 16 *infra*.)

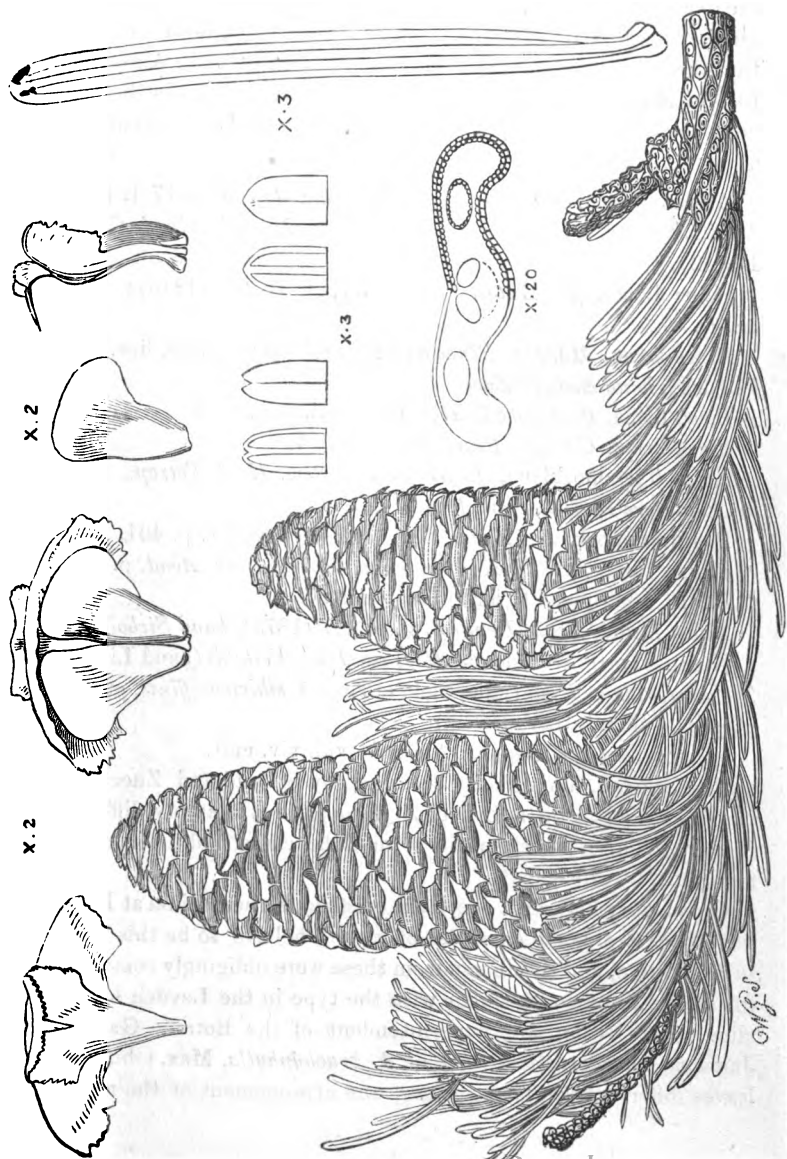

Fig. 16. *Abies sachalinensis*. Foliage and cones (native specimens), of natural size; structural details, magnified

A. Veitchii, var. *sachalinensis*, *Fr. Schmidt, Mém. Acad. Imp. Sc. Pétersb.* 7 sér. tom. xii. n. 2, p. 176, tab. 4. figs. 13-17.

In ins. Sachalin, *Schmidt* ! ; in ins. Yesso, *Maries*, nn. 70, 71, 73, pro parte !

Possibly only a variety of *Veitchii*; but differing in the habit, greater length of leaf, larger cones, and longer bracts (usually quite concealed in *Veitchii*). *Maries'* specimens, however, show that there is considerable variation as to these points. According to *Mr. Maries*, the present species or variety occurs in the lowlands and near the sea-coast in Yesso, while *A. Veitchii* is always a mountain tree in Japan proper.

A. HOMOLEPIS, *Siebold et Zuccarini, Flor. Jap.* ii. p. 17, t. 108! ; *Lindl. et Gord.* ; *Carrière*, ed. 2, p. 290 ; *Mast. in Gard. Chron.* Dec. 27, 1879, p. 828, c. ic.

Pinus homolepis, *Antoine, Conif.* p. 78, t. 31. f. 1 (1846) ; *Endlicher*.

Abies firma, *Murray, Pines and Firs of Japan*, p. 53, figs. 109, 113, 114, *haud Sieb. et Zucc.*

Picea firma, *Parlatore in DC. Prod.* xvi. 2, p. 424.

Picea firma, *Gordon, Pinet.* ed. 2, p. 204.

Abies Tschonoskiana, *Regel in Ind. Sem. Hort. Petrop.* 1865, *ex Parlatore in DC. Prod.* l. c. p. 431.

P. Finnhonoskiana, *Neum. Cat. ex Parlatore*, l. c. p. 431.

Pinus Harryana, *MacNab in Proc. Royal Irish Acad.* p. 689, t. 47. fig. 16 ! (quoad foliorum anatomiam).

Abies Momi, *Koch, Dendrol.* ii. p. 227 (1873), *haud Siebold*.

Nomina hortensia delenda *Abies* seu *Picea Veitchii* (*haud Lindl.*), *Tschonoskiana*, *firma* (*haud Sieb. et Zucc.*), *sibirica affinis*, et *brachyphylla* (*haud Maximowicz*).

In montibus ins. Nippon, *Siebold* ! vidi viv. cult.

This species, imperfectly described by *Siebold* and *Zuccarini*, has been held to be a form of *A. firma* ; but it is amply different in the pulvini of the stem, the form of the leaves, and the arrangement of the resin-canals.

Only a very imperfect specimen exists in the herbarium at Kew ; but there are good examples of what I believe to be this plant in cultivation, and specimens from these were obligingly compared for me by Professor *Suringar* with the type in the Leyden herbarium. *Mr. Syme*, now Superintendent of the Botanic Garden, Jamaica, considers this a form of *A. brachyphylla*, *Max.* ; but the leaves differ in size, form, colour, and arrangement of the resin-

canals. In *A. homolepis* the leaves on the upper surface of the branches are much shorter than those on the lower; while in *A. brachyphylla* they are almost all of the same length; the leaves of the former, moreover, are much more acute than in the latter species. It is quite possible, however, that Mr. Syme's opinion is correct; but in the absence of cones of *A. homolepis* the balance of evidence seems to me to be decidedly in favour of the distinctness of the present species.

A. MARIESII, *Mast. in Gard. Chron.* Dec. 20, 1879, p. 788, c. ic. (Figs. 17, 18.)

In Japonia septentrionali prope Awomori, et in Monte Nikko alt. 3000-7000 ped. *Maries* n. 73, pro parte. V. v. sic. et cult.

This closely resembles *A. brachyphylla*—too closely, perhaps; but it has the young shoots hairy, the pulvini scarcely at all prominent, more deeply sulcate leaves, with the resin-canals subepidermal, not free; larger, broader, and more barrel-shaped cones, the scales of which are entire, not denticulate; and the bracts are denticulate and acuminate. From *A. firma* and the form of that species known as *holophylla*, the present species differs in the more prominent pulvini, the different form of the leaves, the position of the resin-canals, the nearly entire cone-scales, &c.

A. SIBIRICA, *Turcz. Cat. Baik. ex Parlatore in DC. Prod.* xvi. 2, p. 425 (1868); *Regel, Fl. Ussur.* 1862, p. 149; *Ledebour; Carrière; Antoine.*

Pinus Picea, *Pall. Fl. Ross.* i. p. 7, excl. syn.

Pinus Pichta, *Fisch. ex Loddiges' Cat.* 1836, p. 50; *Endlicher, Conifer.* p. 225.

Picea Pichta, *Loudon, Arboret.* iv. p. 2338; *Gordon, Pinetum*, p. 156, ed. 2, p. 221.

Abies Pichta, *Pinet. Woburnens.* t. 39; *Henk. et Hochst.*

In Rossia boreali et media orientali, in Sibiria et Davuria montibus, in Kamtschatka et in Mongolia ad fl. Amur.

A. FORTUNEI, *Murray, Pines and Firs of Japan*, p. 49, c. ic. xylogr.

Abies jezoensis, *Lindl. in Paxt. Fl. Gard.* 1850, p. 43, et in *Gard. Chron.* 1850, p. 311, c. ic. xylogr.; *Van Houtte, Fl. des Serres*, vol. vii. p. 223, vol. xi. p. 7; *Carrière, Traité Général*, p. 255, ed. 1; *Gordon, Pinetum*, ed. 1, p. 17, ed. 2, p. 27; *haud Siebold.*

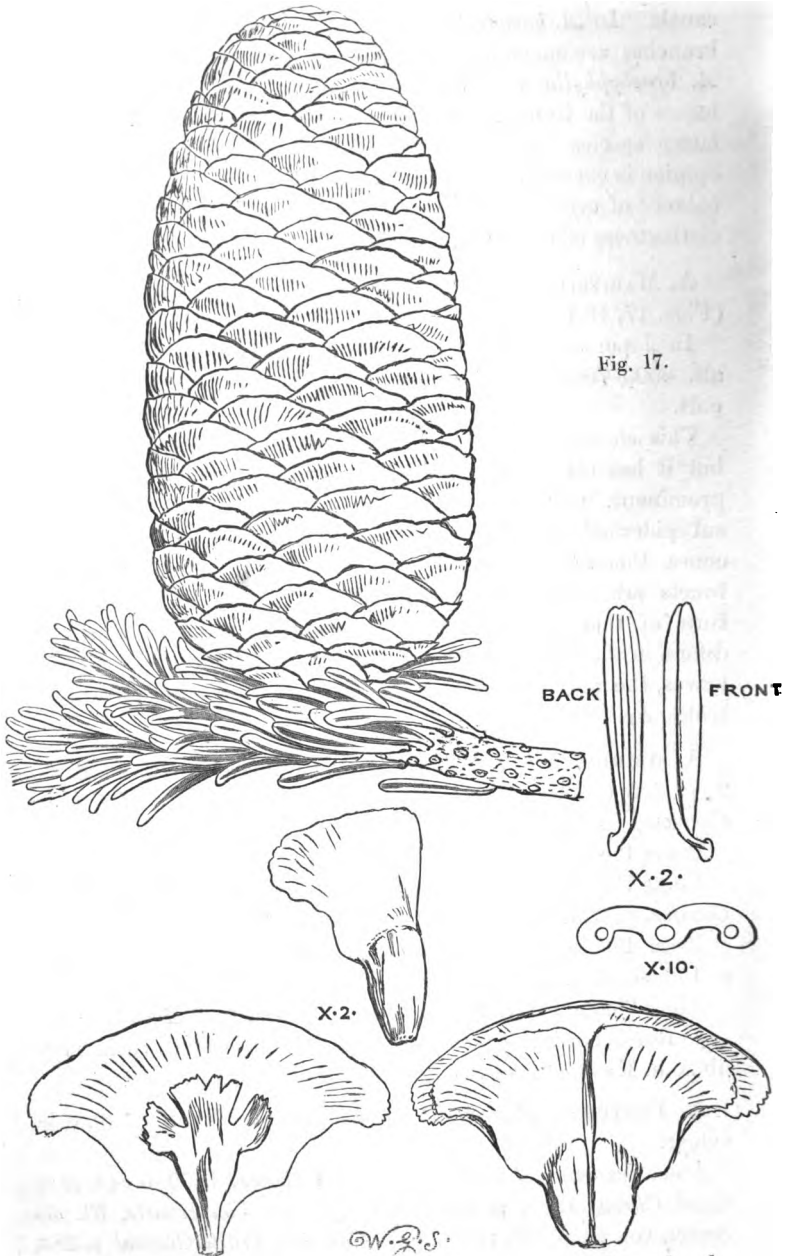

Fig. 17.

Abies Mariesii. Cone, leaves, plan of leaf-section, bract, scales, and seeds (native specimen).

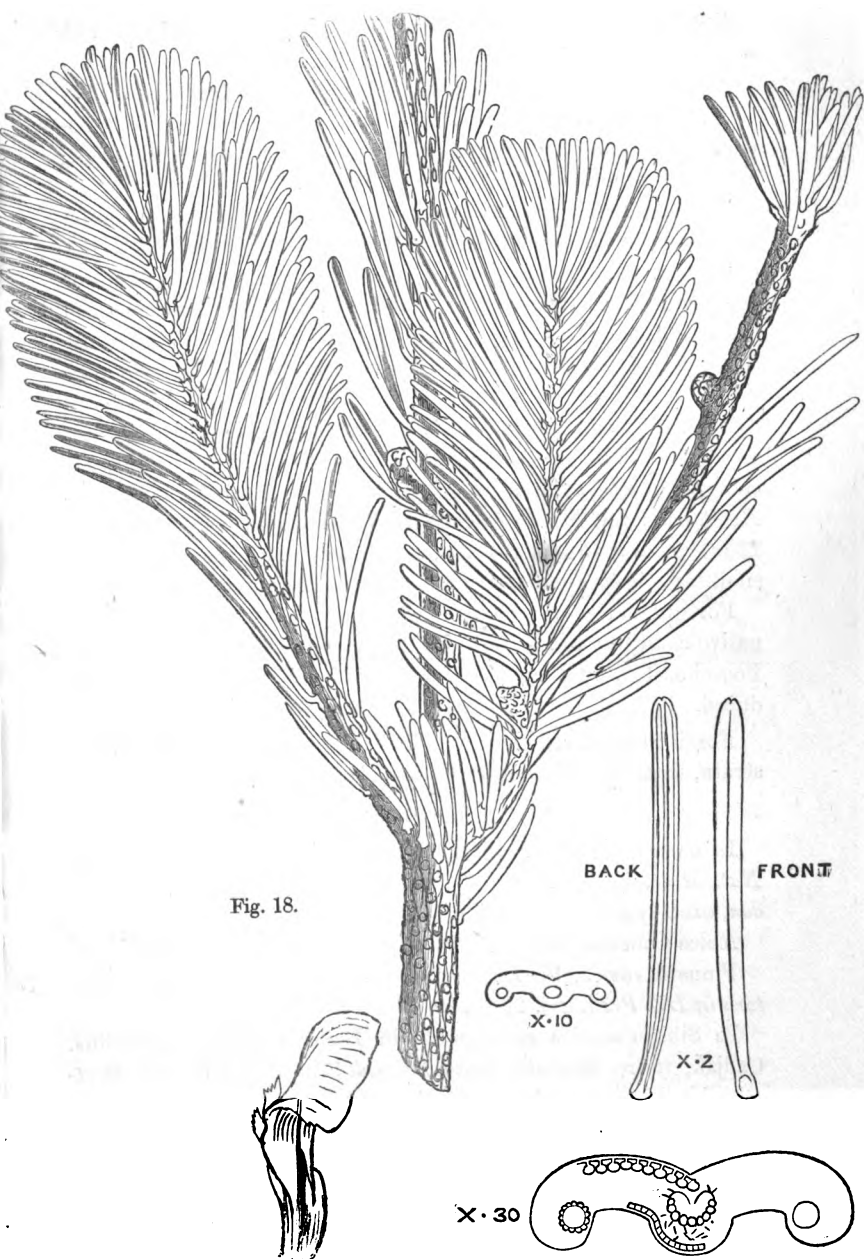

Fig. 18.

Abies Mariesii. Foliage, plan of leaf-section and seed-scale from the side (native specimen).
 LINN. JOURN.—BOTANY, VOL. XVIII.

Keteleeria Fortunei, *Carrière*, *Revue Horticole*, 1866, p. 449, c. ic. ; *et in Traité Général*, ed. 2, p. 260.

In China ad templum prope Foo-chow-foo, *Fortune* n. 50, 52 !

A transverse section of a leaf shows a continuous layer of hypoderm cells and parenchymatous resin-canals, one on each side, and not surrounded by strengthening-cells.

To the late Andrew Murray is due the credit of disentangling the synonymy of this remarkable species. It is, however, not quite clear whether he intended to rank it among the Spruces or among the Silvers ; in fact, he placed it in both sections. But, on the whole, it would appear as if he preferred to place it among the Silver Firs (*Abies* of Continental writers, *Picea* of English gardens). *Carrière* well points out that the appearance of the plant differs from that of any other Conifer yet known—that its cones are those of a Silver Fir (*Abies*), but its scales are persistent, not caducous. On these grounds he established for it the genus *Keteleeria* ; but Mr. Bentham (Benth. et Hook. Gen. Pl. vol. iii. 1880) refers it to *Abies* (Juss., Link), with the remark “est verisimiliter *Abietis* species, strobili squamis diu persistentibus.”

Fortune is the only botanist who has met with the plant in its native country ; and he only saw one tree in a temple-garden near Foo-choo-foo, and conjectures that it may have been introduced.

Fossil remains referred to *Abies* have been met with in various strata, from the Miocene to the Oolite.

LABIX, *Mill.* ; *Benth. et Hook.*

L. DAVURICA, *Turczaninow*, *Cat. Pl. Baic. in Bull. Soc. Imp. Nat. Mosc.* 1838, p. 101 ; *Trautvetter* ; *Carrière*, excl. syn ; *Gordon*, excl. syn. ; *Henk. et Hochst.*

Abies Gmelini, *Ruprecht*, *Fl. Samoij.* p. 56, *ex Parlatore.*

Pinus davurica, *Fischer*, *ex Turcz. Cat. Baik.* n. 1072, *ex Parlatore in DC. Prod.* xvi. 2, p. 410.

In Sibiria arctica et orientali, in Davuria, Ajan, Amur, ins. Cadjak, in ins. Sachalin teste *Schmidt* ! in China boreali, *Bretschneider* ! ; Amur, *Maximowicz* !

L. LEPTOLEPIS, *Endlicher*, *Conif.* p. 130 ; *Gordon* ; *Murray.*

Pinus Larix, *Thunberg*, *Fl. Jap.* p. 275, excl. syn.

Pinus leptolepis, *Parlatore in DC. Prod.* xvi. 2, p. 410.

Abies leptolepis, *Sieb. et Zucc. Fl. Jap.* p. 12, t. 103 ; *J. G. Veitch in Gard. Chron.* 1862, p. 308 ; *Gordon.*

Larix japonica, *Carrière, Conif.* p. 272, ed. 2, p. 353; *Henk. et Hochst.*

In mont. ins. Nippon, *Veitch!*; *Maximowicz!*; in ins. Yesso, *Maries!*

L. SIBIRICA, *Ledeb. Flor. Altaic.* iv. p. 204; *Link*; *Trautvetter*; *Carrière.*

Larix Ledebourii, *Ruprecht, ex Parlatore*; *Gordon in DC. Prod.* xvi. 2. p. 410.

Larix europæa sibirica, *Loudon, Encycl. of Trees*, p. 1054.

Pinus intermedia, *Lodd. Cat., ex Parlatore*, l. c.

Larix intermedia et Archangælica, *Laws., ex Loudon, Arboret.* p. 1055.

Larix decidua β . *rossica*, *Henk. et Hochst., ex Parlatore* l. c.

Pinus Ledebourii, *Endlicher*; *Parlature in DC. Prod.* xvi. 2, p. 410.

In Rossia arctica et septentrionali, et in Sibiria omni, in Manchuria austro-orientali, *Maximowicz!*

§ *Pseudo-Larix.*

L. KÆMPFERI, *Gordon, Pinet.* p. 292; *Murray*; *Henk. et Hochst.*; *Carrière.*

Pinus Kæmpferi, *Lamb. Pinus*, ed. 3, p. vii, *ex Parlature in DC. Prod.* xvi. 2. p. 412 (1868).

Abies Kæmpferi, *Lindl. in Gard. Chron.* p. 255, 1854, c. ic.; *Carrière.*

Larix Kæmpferi, *Carrière in Flore des Serres*, xi. p. 97.

Pseudo-Larix Kæmpferi, *Gordon, Pinetum*, ed. 2, p. 360 (1875).

In montibus Chinæ boreali-orientalis, *Fortune!*

Var. β . *NANA*, colitur.

A transverse section of a leaf shows the midrib prominent on the lower surface, the upper surface being convex. There is a central vascular bundle surrounded by a bundle-sheath and enclosed between palissade cells above and spongy parenchyma below. There are few, if any, hypoderm cells, and no resin-canals. Bertrand, however, detected small ones near the edge of the leaf; so that their presence is variable.

L. PENDULA, *Salisbury in Linn. Trans.* viii. p. 313; *Forbes, Pinet. Woburn.* p. 137, t. 46; *Carrière.*

Pinus pendula, *Solander in Aiton, Hort. Kew.* ed. 1, vol. iii. p. 369, *ex Parlature in DC. Prod.* xvi. 2. p. 409; *Endlicher*; *Willdenow*; *Lambert.*

P. laricina et intermedia, *Duroi, ex Parlature* l. c.

Larix microcarpa, *Pinet. Woburn*, p. 139, t. 47; *Hook. Fl. Bor.-Am.* ii. p. 164; *Link*; *Carrière*; *Gordon*; *Henk. et Hochst.*

Larix americana, *Michaux, Arb. forest. Amér. sept.* iii. p. 37, t. 4.

L. intermedia, *Link in Linnæa*, xv. p. 535; *Pinet. Woburn.* p. 141.

Pinus microcarpa, *Lamb. Pin.* ed. 2, p. 56, t. 37, et ed. 2, p. 87, t. 53; *Meyen, Pl. Labrad.* p. 30; *Antoine*; *Endlicher*:

Abies pendula et microcarpa, *Lindl. et Gord. in Journ. Hort. Soc.* v. p. 213.

Larix decidua γ . *americana*, *Henk. et Hochst. Nadelhölz*, p. 133.

Larix Fraseri, *Curtis, ex Parlatore l. c.*

In America arctica, boreali et orientali usque ad montes Virginiae.

LARICITES is found in Miocene deposits.

On *Arnebia* and *Macrotomia*.

By C. B. CLARKE, M.A., F.L.S.

[Read March 3, 1881.]

ARNEBIA is stated by Kuhn (in 'Botanische Zeitung,' 1867, p. 67) to be dimorphic. I find this to be so in every species. *A. hispidissima*, DC. (figs. 1, 2, 3) is dimorphic in a very common way. Some plants are all long-styled; others are all short-styled: the style may be slightly less divided in the long-styled than in the short-styled. These figures might do for any species of *Arnebia*.

Macrotomia is dimorphic in a similar manner. In the type species of the genus, *M. Benthami* (figs. 4, 5, 6), both the long and short styles are bifid, and are exactly the same as in *Arnebia*. In *Macrotomia perennis* (figs. 7, 8, 9, 10) the long style is subdivided; the short style manifestly bifid. In some other species of *Macrotomia*, similarly dimorphic, the style, whether long or short, is obscurely bifid.

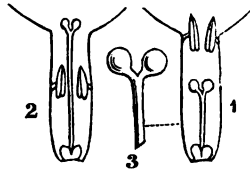

Arnebia hispidissima, DC.
Fig. 1. Short-styled form.
2. Long-styled form.
3. Stigma of short-styled form.

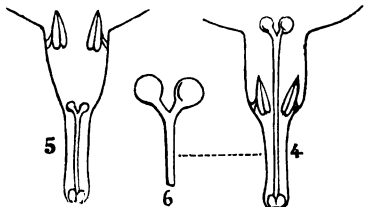

Macrotomia Benthami, DC.
Fig. 4. Long-styled form.
5. Short-styled form.
6. Stigma of long-styled form.

Dimorphism has now been noticed in very many genera. The present case is noticeable for two reasons:—

1st. In the 'Genera Plantarum,' ii. p. 837, Bentham and Hooker, not noticing the dimorphism of these two genera, have separated *Arnebia*, as having a bifid style, from *Macrotomia*, having an entire style, and have removed (Gen. Pl. ii. p. 862) *Macrotomia perennis*, Boiss., to *Arnebia*. The limits of these two genera, if two are to be maintained, will have to be reconsidered.

2nd. One of the earliest good notices of dimorphism relates to *Macrotomia*. Fischer & Meyer, 'Enum. Pl. Schrenk.' p. 34 (published in 1841), write of *Macrotomia perennis*, Boiss. (under the synonym *Stenoselenium perenne*):—"Flores polygami? Inveniuntur enim specimina *brevistyla*, quorum flores staminibus instructi sunt ad faucem corollæ insertis et stylo tubo corollæ duplo brevioris: adsunt alia specimina *longistyla* staminibus in media parte tubi corollæ insertis, stylo tubum superante."

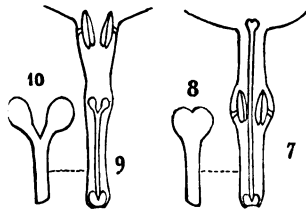

Macrotomia perennis, Boiss.

- Fig. 7. Long-styled form.
8. Stigma thereof.
9. Short-styled form.
10. Stigma thereof.

INDEX.

- Aa**, 341.
- Abelia triflora*, 10, 376, var. *parvifolia*, 64.
- Abies*, 476, 514; *alba*, 479; *ajonensis*, 508; *Alcocquiiana*, 508; *bicolor*, 508; *bifida*, 480, 514; *brachyphylla*, 485, 515, 516, 518; *excelsa*, var. *acicularis*, 508; *firma*, 480, 485, 514, 518, var. *bifida*, 514; *Fortunei*, 481, 485, 519; *Gmelini*, 522; *holophylla*, 514, 515; *homolepis*, 485, 518; *jezoensis*, 509, 519; *Kæmpferi*, 481, 523; *leptolepis*, 522; *Mariesii*, 485, 519, 520, 521; *microcarpa*, 524; *microsperma*, 509; *Momi*, 514, 518; *nephrolepis*, 516; *obovata*, 506, var. *japonica*, 508; *pendula*, 524; *Pichta*, 519; *polita*, 507; *sachalinensis*, 485, 517; *Schrenkiana*, 506; *sibirica*, 485, 518, 519, var. *nephrolepis*, 516; *sitchensis*, 509; *Smithiana*, 11, 14, 98, 374; *Tschonoskiana*, 518; *Tsuga*, 512; *Veitchii*, 485, 515, var. *sachalinensis*, 518; *Webbiana*, 11, 18, 20, 98, 374.
- Abietites*, 485.
- Abola*, 327, 328, 329.
- Acacallis*, 321.
- Acacia Catechu*, 372; *modesta*, 4, 5.
- Acampe*, 334.
- Acanthaceæ* (Afghan), 85.
- Acanthephippium*, 305.
- Acantholimon*, 19, 21; *calocephalum*, 77; *leptostachyum*, 76; *Munroanum*, 76.
- Acer cæsius*, 376; *campestre*, 18; *picatum*, 376; sp. (near *campestre*), 41.
- Aceras*, 351; *angustifolia*, 352; *anthropophora*, 352; *longicurtis*, 353.
- Achillea leptophylla*, 69.
- Acianthus*, 285.
- Acineta*, 322.
- Aconitum heterophyllum*, 375; *Napellus*, 375, var. *rotundifolia*, 12, 31.
- Acræa*, 341.
- Acriopsis*, 338.
- Acrocarpus*, 366.
- Acrochæne*, 291, 296, 302.
- Acropera*, 322.
- Actinella brasiliensis*, 131; *mirabilis*, 130, 132.
- Ada*, 327, 328, 329; *aurantiaca*, 329.
- Adenochilus*, 347.
- Adenoncos*, 335.
- Adenostylis*, 345.
- Adhatoda vasica*, 5, 23, 85.
- Adiantum æthiopicum*, 111; *Capillus-Veneris*, 111; *septentrionale*, 17; *Trichomanes*, 17; *venustum*, 111; *Wattii*, 381.
- Adonis æthiopicum*, 30.
- Ægilops caudata*, 110.
- Æonia*, 333, 336.
- Aeranthus*, 333, 337.
- Aerides*, 333; *affine*, 333; *appendiculatum*, 333; *difformis*, 333; *hystrix*, 333; *japonica*, 336; *latifolia*, 332; *multiflorum*, 333; *tæniale*, 332, 333; *Wightianum*, 333.
- Æsculus indica*, 374.
- Æthialium septicum*, 387.
- Ætheria*, 346; *fusca*, 344.
- Afghanistan, Flora of Kuram Valley, Surg.-Maj. Aitchison on, 1.
- Barks, 28; Bees, 28; Charcoal, 26; Dyes, 26; Fibres, 27; Fodder for Animals, 25; Forests, 26; Gen. Observ. on Districts traversed, 1; Geogr. and Gen. conform. of Country, 2; Indigen. Plants for Food in use, 24; Medicines and other Veg. products, 25; Oils, 26; Plants cultiv. for food, 22; Poisons, 26; Sericulture, 28; Soap, 26.
- Aganisia*, 319, 320; *lepida*, 321.
- Agaricus acetabulosus*, 389; *campestris*, 24, 113; *cynopotamia*, 389; *gomphomorphus*, 383; *laccatinus*, 383;

- pediades, 383; *sapineus*, 383; *Thozetii*, 383; *vaginatus*, 383.
- Agave americana*, 145.
- Aggeianthus*, 302.
- Agrimonia Eupatorium*, 54; *pilosa*, 54.
- Agropyrum orientale*, 110; *repens*, 110, var. *minor*, 110; *semicostatum*, 110; sp., 110.
- Agrostis alba*, 107; sp., 107.
- Agrostophyllum*, 307; *megalurus*, 307.
- Ainsliea aptera*, 72.
- Aitchison, J. E. T., *Flora of Kuram Valley*, 1.
- Ajuga bracteosa*, 89; *parviflora*, 89.
- Alæcida* (subg.), 116.
- Alamania*, 311.
- Alberta laurifolia*, 271.
- Albizzia Julibrissin*, 372; *odoratissima*, 372.
- Algæ from Amazons, 125.
- Alikhél, *veget. spurs of*, 17.
- Alisma Plantago*, 99.
- Alismacæ (Afghan), 99.
- Allium*, 21; *capitellatum*, 101; *Griffithianum*, 101; *neapolitanum*, 101, 143; *robustum*, 20, 101; *roseum*, 143; *senescens*, 13; sp., 101; *umbilicatum*, 101.
- Allman, Prof., *Anniversary Address*, 135.
- Aloe*, 153; *abyssinica*, 154, 174, var. *Peacockii*, 175, var. *percrassa*, 175; *africana*, 155, 180; *agavæfolia*, 154, 166; *albisipina*, 154, 172; *albo-cincta* × *grandidentata*, 154, 164; *andongensis*, 154, 173; *angolensis*, 154, 162; *arabica*, 155, 181; *arborescens*, 154, 175, var. *frutescens*, 175; *aristata*, 153, 156, var. *leiophylla*, 156; *Atherstonei*, 154, 170; *Bainesii*, 155, 178; *Barteri*, 154, 168; *Bolusii*, 155, 179; *Bowiea*, 153, 158; *brevifolia*, 153, 160, vars. *postgenita*, 160, *depressa*, 160; *cæsia*, 154, 172; *chinensis*, 153, 161; *chloroleuca*, 155, 177; *ciliaris*, 154, 169; *claviflora*, 155, 181; *commutata*, 154, 165; *consobrina*, 154, 168; *constricta*, 154, 168; *Cooperi*, 153, 155; *crasipes*, 153, 162; *dichotoma*, 155, 178; *distans*, 154, 171; *drepanophylla*, 155, 176; *Ecklonia*, 153, 158; *elongata*, 176; *falcata*, 155, 181; *ferox*, 155, 179, vars. *incurvata*, 180, *subferox*, 180; *gasterioides*, 154, 166; *glauca*, 153, 160, var. *muricata*, 161; *gracilis*, 154, 170; *grandidentata*, 154, 166; *Greenii*, 154, 165; *heteracantha*, 153, 161; *humilis*, 153, 157, vars. *acuminata*, 157, *Candollei*, 157, *incurva*, 157, *macilenta*, 157; *inermis*, 155, 181; *Kraussii*, 153, 159; *latifolia*, 154, 164; *leptophylla*, 165; *lineata*, 153, 159; *littoralis*, 154, 174; *lomatophylloides*, 154, 162; *longistyla*, 153, 158; *Macowani*, 154, 170; *macracantha*, 154, 167; *macrocarpa*, 154, 163; *micracantha*, 153, 159; *microstigma*, 154, 167; *mitriformis*, 154, 171, vars. *Commelyni*, 171, *flavisipina*, 171, *pachyphylla*, 172, *spinulosa*, 171, *xanthacantha*, 172; *myriacantha*, 153, 156; *nitens*, 154, 170; *nobilis*, 154, 172, var. *densifolia*, 172; *obscura*, 154, 165; *palmiformis*, 154, 173; *pendens*, 155, 181; *Perryi*, 153, 161; *platylepis*, 155, 177; *platyphylla*, 154, 167; *plicatilis*, 155, 181, var. *major*, 181; *pluridens*, 154, 176; *pratensis*, 153, 156; *purpurascens*, 154, 174; *rhodocincta*, 163; *Salmodyckiana*, 155, 177; *Saponaria*, 154, 164, vars. *brachyphylla*, 164, *luteo-striata*, 164; *Schimperi*, 153, 159; *Schweinfurthii*, 154, 175; *Serra*, 153, 160; *serrulata*, 154, 163, var. *pallascens*, 163; *sigmoidea*, 155, 177; *spiciosa*, 155, 178; *spicata*, 154, 168; *striata*, 154, 162; *striatula*, 154, 169; *subrecta*, 157; *subtuberculata*, 157; *succotrina*, 154, 173; *supralævis*, 155, 180; *tenuifolia*, 154, 163; *tenuior*, 154, 169; *Thraskii*, 155, 180; *tricolor*, 154, 166; *tuberculata*, 157; *variegata*, 155, 179; *vera*, 155, 176, vars. *littoralis*, 176, *officinalis*, 176; *virens*, 153, 157, var. *macilenta*, 158; *zebrina*, 154, 167.
- Aloes*, 148; mem. on collect. of, 150; remarks on distrib. of, 149, 151.
- Aloinæ* and *Yuccoidæ*, *Synopsis of*, by J. G. Baker, 148.
- (tribe defined), 152.
- Alopecurus agrestis*, 105.
- Alps, *veget. of maritime*, 135.
- Altensteinia*, 341.
- Althæa officinalis*, 39; *rosea*, 9, 17, 39.
- Alvisia*, 303.
- Alysia*, 294.
- Alyssum campestre*, 33; *minimum*, 33; *persicum*, 20, 33; sp. ?, 33.
- Amarantacæ (Afghan), 89.
- Amarantus Blitum*, 89; *frumentaceus*, 89.
- Amazons, *Algæ from*, 123.
- Amblostoma*, 291, 310; *densum*, 310; *micranthum*, 310.
- Amblyglottis*, 308.
- Ambrosinia Bassii*, 245.

- Ambrosininae, 245.
 Amlok, 9.
 Ammannia senegalensis, 59.
 Ampelideæ (Afghan), 41.
 Amphiglottis 313, 314.
 Amphora delphinia, 132; gracilis, 131.
 Amphorchis, 357; calcarata, 357.
 Amygdalus eburnea, 16; sp., 10, 18.
 Anabæna bullosa, 126; chilensis, 126; gigantea, 126; scabra, 126.
 Anacamptis, 251.
 Anacardiaceæ (Afghan), 42.
 Anacheilum, 314.
 Anagallis arvensis, 78, 456.
 Anaphalis, 21; tenella, 68; virgata, 68.
 Anchusa Milleri, 81.
 Andrachne telephioides, 93.
 Andromeda ovalifolia, 374.
 Andropogon punctatus, 111; sp., 111.
 Androsace cordifolia, 373; incisa, 77, 373; lanuginosa, 373; mucronifolia, 381; sarmentosa, 373; sp., 77, 78.
 Anemone biflora, 16, 30; coronaria, 143; hortensis, 143; incisa, 13; rivularis, 373; sp. nov., 30.
 Angræcum, 284, 335; aphyllum, 337; armeniacum, 336; caudatum, 336; caulescens, 337; distichum, 337; falcatum, 336; funale, 336; gladiifolium, 336; infundibulare, 336; pectinatum, 337; pellucidum, 337; sesquipedale, 333, 336.
 Anguloa, 321.
 Ania, 306; angustifolia, 306.
 Anniversary Address of the President, Prof. Allman, 135.
 Anæctochilus, 344, 345; albolineatus, 344; brevilabris, 344; flavus, 344; grandiflorus, 344; Jauberti, 344; lanceolatus, 344; longiflorus, 344; sandwicensis, 344.
 Anosporum, 364.
 Ansellia, 313.
 Anthistiria anathera, 111.
 Anthogonium, 305, 306.
 Apatura, 304; montana, 347.
 Apetalon, 348.
 Aphanocapsa membranacea, 128.
 Aphloia theæformis, 265.
 Aphyllanthus monspeliensis, 143.
 Aphyllorchis, 346, 347.
 Apicra aspera, 217, 218, var. major, 219; bicarinata, 217, 219; congesta, 217, 218; deltoidea, 216, 217; foliolosa, 217, 218; pentagona, 216, 217, vars. bullulata, 217, spirella, 217, Willdenovii, 217; spiralis, 216, 217.
 Apista, 338.
 Apium graveolens, 61.
 Aplectrum, 295.
 Aplostellis, 348.
 Aponogeton quadrangulare, 279; ulvaceum, 279.
 Aporum, 297.
 Apostasiæ, 285, 286, 359, 360.
 Appendicula, 338.
 Aquilegia glauca, var. nivalis, 378; vulgaris, vars. fragrans, 31, Moorcroftiana, 31, pubiflora, 31; sp. nov., 31.
 Arabis amplexicaulis, 33; bijuga, 378; nuda, 33, var. (hirsute poda), 33; pangiensis, 378; sp. ? , 33.
 Arachnanthe, 331, 332, 333.
 Araliaceæ (Afghan), 64.
 Arbutus Unedo, 138.
 Arctium Lappa, 70.
 Arcyria ferruginea, 387; nutans, 387.
 Arenaria foliosa, 38; Griffithii, 38; Meyeri, 38; serpyllifolia, 38; sp. ? , 38.
 Arethusa, 348.
 Arethuseæ, 285, 286, 288, 339, 347.
 Argyrorchis, 346, 360.
 Arineæ, 254.
 Arisæma abbreviatum, 99; album, 247; angustatum, 251; atrorubens, 250; concinnum, 254; decipiens, 251; Dracontium, 252; flicaudatum, 253; filiforme, 252; galeatum, 246; Griffithii, 250; heterophyllum, 250; japonicum, 252; laminatum, var. inclusum, 249; Murrayi, 254; nepenthoides, 254; penicillatum, 242, 248; pulchrum, 252; ringens, 250; serratum, 252; sikokianum, 251; speciosum, 249; Thunbergii, 252; utile, 250.
 Arisareæ, 246.
 Arisarum proboscideum, 246; vulgare, 246.
 Aristotelea, 343.
 Armadorum, 333.
 Arnebia and Macrotonia, C. B. Clarke on, 524.
 Arnebia, dimorphism of, 524; endochroma, 19, 25, 81; hispidissima, 524; speciosa, 81.
 Arnottia, 352.
 Aroidæ (Afghan), 99.
 —, N. E. Brown on new forms of, 242.
 Arpophyllum, 293.
 Arrhynchium, 332.
 Artemisia, 19, 21, 24; Absinthium, 70; parviflora, 70; persica, 70; scoparia, 70; sp., 16; Tournefortiana, 16, 70.
 Arthrodesmus bifidus, 129.
 Arum creticum, 258; Griffithii, 16, 99, 257; italicum, 258; maculatum, 258; nigrum, 257; numidicum, 258; orientale, 258; syriacum, 257.
 Arundina, 307, 309.

- Arundo**, 27; **Donax**, 108, 143.
Asarca, 349.
Aschisma (subg.), 117.
Asclepiadæ (Afghan), 79.
Ascobolus australis, 389.
Asparagus brachyphyllus, 103; **capitatus**, var., 103; **trichophyllus**, 103.
Aspasia, 326.
Aspects of Vegetation in Littoral districts of Provence, 135.
Asperugo procumbens, 81.
Asperula Cynanchica, 66; **odorata**, 66; **pycnantha**, 66; sp., 66.
Asphodelus cerasiferus, 142; **microcarpus**, 142.
Aspidium Prescottianum, 11, 112.
Asplenium alternans, 373; **Ceterach**, 112; **fontanum**, 11, 112; **Rutamura**, 17, 20, 22, 112; **septentrionale**, 11, 112; **Trichomanes**, 11, 112; **varians**, 11, 112; **viride**, 11, 112.
Aster altaicus, 7, 16, 67; **Amellus**, 11, 68; **heterochæta**, 21, 68; **roseus**, 68.
Astragalus anfractuosus, 7, 44; **cerasinus**, 47; **coluteocarpus**, 44; **decemjugus**, 7, 44; **graveolens**, 44; **hippocrepidis**, 7, 44; **immersus**, 45; **infestus**, 45; **Kuramensis**, 7, 46; **leucocephalus**, 7, 45; **luteo-cæruleus**, 47; **microdontus**, 46; **murinus**, 45; **polyacanthus**, 6, 7, 21, 45; **psilacanthus**, 7, 45; **ptiloccephalus**, 7, 47; **purpurascens**, 45; **raphiodontus**, 45; **rhizanthus**, 17, 45; **rhizocephalus**, 46; sp. (near **auganus**), 46; sp. (near **conferta**), 21; sp. (near **horridus**), 46; **strobiliferus**, 7, 45; **Susianus**, 7, 47; **tephrosioides**, 20, 45; **verticillaris**, 17, 45.
Ate, 355.
Athrixia fontana, 391.
Atractylis cuneata, 16, 70.
Atropa lutescens, 26, 82.
Auliseum, 314.
Auliza, 314.
Aurantiacæ of Riviera, 138.
Auricularia pusio, 386.
Australian Fungi.—II. Received principally from Baron F. von Mueller. By the Rev. M. J. Berkeley, 383.
Avena fatua, 23, 108; **oligostachya**, 11, 108.
Avicpeps, 357.
Badula laurifolia, 272.
Baker, J. G., Notes on a Collection of Flowering Plants made by L. Kitching in Madagascar in 1879, 264.
Baker, J. G., Synopsis of Aloinæ and Yuccoideæ, 148.
Barbarea vulgaris, 33, var. **taurica**, 33.
Barkeria, 313.
Barlæa, 355.
Barlia, 351, 355.
Bartholina, 352, 353.
Bartramia fontana, 113.
Baskervillea, 341, 343.
Batemannia, 321.
Baterrea phalloides, 386.
Batrachospermaceæ, 123.
Batrachospermum moniliforme, vars. **nodiflorum**, 123, **proliferum**, 123.
Bauhinia Vahlîi, 372, 381; **variegata**, 374.
Beaucarnea Bigelovii, 233, 255; **erumpens**, 233, 235; **Hartwegiana**, 234, 237; **humilis**, 234, 237; **Lindheimeriana**, 233, 236; **longifolia**, 233, 234; **microcarpa**, 233, 236; **Palmeri**, 233, 235; **parviflora**, 233, 234; **recurvata**, 233, 234, vars. **intermedia**, 234, **rubra**, 234, **stricta**, 234; **texana**, 234, 236; **Watsoni**, 233, 236.
Beauvois's genera of Cyperacæ, 360.
Beclardia, 336.
Becquerelia, 367.
Beera, 361.
Beggiatoa alba, 127; **arachnoidea**, 127.
Begonia alæcida, 117; **albo-coccinea**, 117; **amœna**, 118; **andamensis**, 116; **barbata**, 119; **Brandisiana**, 117; **brevicaulis**, 119; **canarana**, 116; **Cathcartii**, 119; **concanensis**, 117; **cordifolia**, 118; **crenata**, 116; **delicatula**, 116; **Dux**, 115; **episcopalis**, 119; **Evansiana**, 118; **fallax**, 118; **fibrosa**, 117; **flaccidissima**, 116; **floccifera**, 117; **gemmipara**, 118; **gigantea**, 119; **goniotis**, 119; **Griffithii**, 119; **guttata**, 119; **inflata**, 115; **integrifolia**, 119; **Josephi**, 118; **laciniata**, 119; **malabarica**, 117; **martabanica**, 116; **megaptera**, 119; **modestiflora**, 118; **moulmeinensis**, 118; **nivea**, 117; **ovatifolia**, 118; **paleacea**, 116; **Parishii**, 116; **parvuliflora**, 118; **pedunculosa**, 118; **picta**, 118; **procridifolia**, 119; **prolifera**, 115; **Rex**, 119; **Roxburghii**, 115; **rubro-venia**, 119; **sandalifolia**, 119; **satrapis**, 118; **scutata**, 118; **serculigera**, 118; **sikkimensis**, 119; **silhensis**, 115; **sinuata**, 116; **subpeltata**, 117; **superfoliata**, 118; **tenera**, 117; **tessericarpa**, 115; **Thomsonii**, 119; **trichocarpa**, 117; **tricuspidata**, 117; **triradiata**, 117; **verticillata**, 117;

- 115; *Wallichiana*, 117; *xanthiana*, 117.
Begonias, on Indian, 114.
Begoniella, 114.
Belis jacuifolia, 502.
Bentham, G., Notes on Orchideæ, 281.
 —, Notes on Cyperaceæ; with special reference to *Lestiboudois's* "Essai" on *Beauvois's* Genera, 360.
Benthamia, 354.
Berberidæ (Afghan), 31.
Berberis, 376; *aristata*, 372; *callibotrys*, 31; *cretica*, 31; *Lycium*, 372; *nepalensis*, 372; *orthobotrys*, 31; sp., 10, 31, 32.
Berchemia, 10, 24; *lineata*, 40.
Berkeley, Rev. M. J., *Australian Fungi*. II., 383.
Betula Bhojpattra, 12, 28, 95.
Biarum angustatum, 255; *Fraasianum*, 254; *Haensleri*, 255; *Sewerzowi*, 255; *tenuifolium*, 255.
Bicchia, 354.
Bicornella, 352, 353.
Bidens pilosa, 69; *tripartita*, 69.
Bidie, W., Remarks on the Indian Coffee-leaf Disease, 458.
Bieneria, 349.
Bifrenaria, 321, 323; *Hadwenii*, 324.
Bilabrella, 355.
Biota, 476, 488; *meldensis*, (ftnote) 495; *orientalis*, 388, var. *meldensis*, (ftnote) 495; *pendula*, 488.
Bipinnula, 349.
Birchia, 331.
Bletia, 285, 296, 304, 305, 311; *aphylla*, 296, 305; *hyacinthina*, 305; *pratensis*, 314; *Schomburgkii*, 314.
Bleticæ, 287, 290, 304, 339.
Bletilla, 305.
Blitum virgatum, 90.
Blumea Wightiana, 68.
Blysmus, 362.
Boeckler's div. of *Cyperaceæ*, 364.
Boletus Thoretii, 384.
Bollea, 320.
Bolus, H., and *MacOwan*, P., *Novitates Capenses: Descriptions of New Plants from the Cape of Good Hope*, 390.
Bonatea, 352, 356; *Boltoni*, 356; *foliosa*, 356; *speciosa*, 356; *tetrapetala*, 355.
Bonatea, 355.
Boraginæ (Afghan), 80.
Botrychium Lunaria, 12, 112.
Boucerosia Aucheri, 24.
Brachionidium, 292.
Bractia, 327.
Brachyactis robusta, 68; *pubescens*, 68.
Brachycorythis, 358.
Brachypodium tataricum, 22, 109.
Bramble, observations on, by F. Darwin, 406; experiments on, 409; theory of growth of cuttings, 406; *Sachs's* views, 408; *Vöchting's* law, 407.
Brassavola, 312; *Digbyana*, 314; *glauca*, 314.
Brassia, 327, 328; *campestris*, 34; *cinnabarina*, 329.
Brexia madagascariensis, 268.
British Lahoul, Notes on the Vegetation of, 368; inhabitants of, 371.
Bromheadia, 319.
Bromus Danthoniæ, 109; *erectus*, var., 21; sp., 109.
Broughtonia, 314.
Brown, N. E., on new *Aroideæ*, 242.
Brownleea, 358.
Brunella vulgaris, 88.
Bryobium, 303.
Bryonia dioica, 15, 60.
Bryophyllum calycinum, 268.
Bucculina, 353.
Buddleia, 10; *crispa*, 7, 8, 79.
Bulbochæto pedicellata, 124.
Bulbophyllopsis, 301.
Bulbophyllum, 294, 295, 296, 297, 298, 300, 301; *bisetum*, 299; *bracteolatum*, 299; *cirropetaloides*, 299; *clavatum*, 299; *prismaticum*, 299; *Regnelii*, 299; *reptans*, 298; *sordidum*, 299.
Bupleurum falcatum, 60, var. *linearifolium*, 60; sp., 21, 61.
Burlingtonia, 326; *maculata*, 326.
Cadetia, 297.
Caladenia, 284.
Calamagrostis lanceolata, 107; sp., 107.
Calamintha Clinopodium, 86; *debilis*, 86; sp., 86.
Calanthe, 284, 285, 306, 307, 308; *brevicornis*, 309; *curculigoides*, 309; *densiflora*, 309; *gracilis*, 309; *veratrifolia*, 291; *vestita*, 309.
Callianthemum cachemirianum, 30.
Callipeltis Cucullaria, 65.
Callostylis, 307.
Calocedrus macrolepis, 485.
Calodryum tubiflorum, 266.
Calopogon, 348; *pulchellus*, 348.
Calothrix scopulorum, 134.
Calotropis sp., 5.
Caltha palustris, 30.
Calycotoma spinosa, 141.

- Calypso, 295.
 Calyptrocarya, 366.
 Calystegia sp., 82.
 Camaridium, 324.
 Camarotis, 333.
 Cameron, J., letter from W. Bidie on Indian Coffee-leaf Disease, 458.
 Campanula colorata, 74; *evolvulacea*, 74; *Griffithii*, 74; sp., 17, 21, 74.
 Campanulaceæ (Afghan), 74.
 Campylocentrum, 337.
 Candelillo, or coffee-disease, 462.
 Cannabis, 26; *sativa*, 94.
 Cape plants, new species of, 390.
 Capparidæ (Afghan), 35.
 Capparis aphylla, 5.
 Caprifoliaceæ (Afghan), 64.
 Capsella Bursa-pastoris, 34.
 Capsicum frutescens, 82.
 Caragana, 18; *acaulis*, 44; *ambigua*, 27, 43; *arborescens*, 44; *brevispina*, 43; *brevissima*, 10; *grandiflora*, 44; *ulicina*, 6, 44.
 Cardamine impatiens, 33.
 Carduus acanthoides, 16, 17.
 Carex, 363, 364, 365, 367; *Aitchisoni*, 105; *alpina*, 104; *cardiolepis*, 105, var. 105; *divisa*, 19, 105; *hirta*, var., 105; *hirtella*, 105; *linearis*, 367; *nutans*, 105; *Oliveri*, 104; *semper-virens*, 105; sp., 104, 105; *stenophylla*, 105; *vulgaris*, 20, 105.
 Caricæ, 367.
 Carpesium cernuum, var. *pubescens*, 69.
 Carpha, 364, 367.
 Carteretia, 332.
 Carthamus oxyacantha, 72.
 Carum Bulbocastanum, 16, 24, 61, var., 61; *copticum*, 61.
 Caryophylleæ (Afghan), 36.
 Casparya, 114, (subgen.) 115.
 Cassia fistula, 372.
 Casuarina, 145.
 Catagyne, 361.
 Catasetidæ, 322.
 Catasetum, 322.
 Cattleya, 314.
 Caucais Anthriscus, 64; *latifolia*, 64.
 Caudicle of Orchids, 285.
 Caustis, 364.
 Cedrela Toona, 374.
 Cedrus Deodara, 98, 369, 373, 374.
 Celastrinæ (Afghan), 40.
 Celastrus paniculata, 374.
 Celtis, 7, 27; *caucasia*, 93.
 Cemiostoma coffeellum, 463.
 Centaurea calcitrapa, 72; *depressa*, 72; *Picris*, 72; *virgata*, 72.
 Centauroopsis fruticosa, 271.
 Centrochilus, 355.
 Centropetalum, 330, 331.
 Centrosis, 308.
 Cephalanthera, 344, 349; *ensifolia*, 100; sp., 100.
 Cephalaria sp., 14, 67; *syriaca*, 66.
 Cephalocarpus, 366.
 Cephalotaxus, 475, 476, 499; *Buergeri*, 499; *drupacea*, 483, 499; *coriacea*, 499; *Fortunei*, 483; *pedunculata*, 483, 499, vars. *Buergeri*, 499, *fastigiata*, 499; *sumatrana*, 475; *umbra-culifera*, 483, 499.
 Cerastium dichotomum, 37; *vulgatum*, 37.
 Ceratandra, 358.
 Ceratium, 303; *hydroideum*, 388.
 Ceratoneis alpina, 130, 132; *Arcus*, 131; *excisa*, 130.
 Ceratonia Siliqua, 138.
 Ceratopsis, 349.
 Ceratostylis, 307.
 Cercis siliquastrum, 139.
 Cercospora, (fntote) 466; *coffeicola*, 467.
 Cerochilus, 346.
 Ceterach, 17.
 Chæradoplectrum, 354.
 Chænoyucca, 220.
 Chærophyllum reflexum, 61.
 Chætophoraceæ, 123.
 Chamæcyparis, 476, 478, 489; *andelyensis*, (fntote) 495; *breviramea*, 494; *decussata*, (fntote) 495; *ericoides*, (fntote) 495; *fusifera*, 478, 490; *leptoclada*, (fntote) 495; *nutkaensis*, 478; *obtusata*, 478, 491; *pendula*, 494; *sphæroidea*, (fntote) 495, var. *andelyensis*, (fntote) 496; *squarrosa*, 490, (fntote) 495, var. *leptoclada*, 490, (fntote) 495; *thuyoides*, 478.
 Chamærops, 6; *humilis*, 144; *Ritchiana*, 5, 24, 27, 99.
 Chamorchis, 352.
 Chaubardia, 320.
 Cheiradenia, 320.
 Chelonanthera, 308.
 Chenopodiaceæ (Afghan), 89.
 Chenopodium, *album*, 89, var. *candicans*, 89, var., 89; *Botrys*, 89; *murale*, 90; sp., 90.
 Chiloschista, 333.
 Chironia littoralis, (fntote) 401; *madagascariensis*, 273; *suffruticosa*, 401.
 Chloïdia, 341.
 Chloræa, 349.
 Chloris villosa, 108.
 Chlorophyll, application of the results

- of Pringsheim's recent Researches on, to the Life of the Lichen, 147.
- Chlorosa*, 348.
- Chœnanthe*, 325.
- Chondrioderma spumarioides*, 387.
- Chondrorhyncha*, 322, 323.
- Chorispora*, sp. (near *Bungeana*), 35; *tenella*, 35, var. ?, 18, 35.
- Chroococcaceæ, 128.
- Chroolepidæ, 124.
- Chroolepus flavum*, 124.
- Chrysanthemum Parthenium*, 69.
- Chrysobaphus*, 344.
- Chrysocynis*, 323.
- Chrysoglossum*, 291, 296, 302.
- Chthonoblastus oligothrix*, 127.
- Chumba State, climate and flora of, 371.
- Chysis, 305.
- Chytroglossa*, 329.
- Cicer soongaricum*, 20, 49, var. *spinosum*, 49.
- Cichorium Intybus*, 72.
- Cineraria maritima*, 143.
- Cioniascus*, 345.
- Cirr hæa*, 338.
- Cirrhoptalum*, 299, 300; *bootanense*, 300; *Elisæ*, 300; *maculosum*, 300; *refractum*, 300; *Wallichii*, 300.
- Cistella*, 318.
- Cistus albidus*, 141; *monspeliensis*, 141; of *Riviera*, 141; *salvifolius*, 141.
- Cladobium*, 310.
- Cladophora mollis*, 124.
- Cladosporium stenospodium*, 388, 466.
- Clara ophiopogonoides*, 241.
- Clarke, C. B., on *Arnebia* and *Macrotonia*, 524.
- , on *Indian Begonias*, 114.
- , on *Right-hand and Left-hand Contortion*, 468.
- Clathroptychium*, 3; *rugulosum*, 387.
- Cleisostama*, 333; *ionosmum*, 335; *maculosum*, 334, 335; *tridentatum*, 335.
- Cleistis*, 348.
- Clematis Buchananiana*, 374; *grata*, 29; *graveolens*, 29; *ibarensis*, 264; *montana*, 375; *oligophylla*, 265; *Robertsiana*, 13, 29; *strigillosa*, 265.
- Cleome iberica*, 35.
- Clerodendron macrocalycinum*, 275.
- Clistoyucca*, 220.
- Clitoria lasciva*, 267.
- Closterium incurvum*, 129; *parvulum*, 129; *Pritchardianum*, 129.
- Clowesia*, 323.
- Cnemidia*, 341.
- Cneorum ricocum*, 143.
- Cnicus argyranthus*, 71; *arvensis*, 71; *horridus*, 71.
- Cocconeis placentula*, 130.
- Cocculus Leмба*, 5.
- Cochlea*, 299.
- Cochlioda*, 326, 328.
- Codiolum gregarium*, 132; peculiarities in reproduction of, 134.
- Codium tomentosum*, 134.
- Codonopsis ovata*, 21, 74.
- Codonorchis*, 348.
- Cœlia*, 302, 303.
- Cœliopsis*, 322.
- Cœloglossum*, 354; *lacertiferum*, 354.
- Cœlogyne*, 301, 307; *bilamellata*, 301; *prolifera*, 302.
- Cœlogyneæ*, 287, 291, 306.
- Cœnorchis*, 345.
- Coffee-leaf Disease, Remarks on *Indian*, by W. Bidie, 458; on *South-American*, by M. C. Cooke, 461.
- Cohnia*, 329.
- Colacastrum*, 324.
- Colatea arborescens*, 43.
- Colax*, 321, 322.
- Colea floribunda*, 274.
- Coleochæte scutata*, 123.
- Collabium*, 291, 296, 302.
- Colleus*, 343.
- Coltonia championi*, 331; *peduncularis*, 331.
- Combretum pachyaladum*, 270.
- Comparettia*, 325.
- Comperia*, 351.
- Compositæ* (*Afghan*), 67.
- Compsopogon leptocladus*, 123.
- Conchidium*, 303.
- Conchochilus*, 338.
- Conferva antillarum*, 124.
- Confervaceæ, 124.
- Coniferæ* (*Afghan*), 97; *geograph. distrib. of*, 483; of *America and Japan compared*, 478; of *Riviera and Provence*, 139.
- Conifers of Japan*, by Maxwell T. Masters, 473; *centre of origin*, 479; *larval stages of*, *Carrière on*, 481; *leader shoots of*, 482; *structure leaves of*, 482; *table geogr. distrib. of*, 483.
- Conium maculatum*, 15, 61.
- Conopodium* sp., 61.
- Conringia* sp. (near *perfoliata*), 34.
- Contortion, right and left*, C. B. Clarke, on, 468; *Bentham on*, 472; *DeCandolle on*, 471; *Linnæus's defin. of*, 469.
- Convolvulacæ (*Afghan*), 81.
- Convolvulus altheoides*, 142; *arvensis*, 82; *lanuginosus*, 6, 7; *lineatus*, 82; *pseudocantabrica*, 19, 82; sp., 82.

- Cooke, M. C., the Coffee-disease in South America, 461.
- Corallorhiza, 284, 295, 296, 305.
- Cordyla, 348.
- Cordylestylis, 345.
- Coris monspeliensis, 143.
- Cornus macrophylla, 374.
- Coronilla, 140; valentina, 143.
- Corticium anthochroum, 386; arachnoideum, 386; viscosum, var. deglubens, 386.
- Cortusa Matthioli, 78.
- Coryanthes, 322, 347.
- Coryciæ, 288, 358.
- Corycium, 358.
- Corydalis cachemiriana, 375; meifolia, 32; sp. (near rutæfolia), 32.
- Corylus Colurna, 376.
- Corymbæ, 339, 340.
- Corymbiæ, 288.
- Corymbis, 340, 341, 359; Botrytis, 128.
- Cosmarium globosum, 129; granatum, 129; ornatum, 128; pseudo-connatum, 129; pulcherrimum, 129; venustum, 129.
- Cotoneaster, 6, 8, 10, 14, 15, 16, 376; bacillaris, 10, 27, 56; nummularia, 6, 10, 16, 18, 56, var. tomentosa, 56; sp.?, 56; vulgaris, var., 56.
- Cottonia, 331.
- Cotyledon pannosa, 269; papillosa, 58; tenuicaulis, 57.
- Cousinia microcarpa, 19, 70; minuta, 19, 71; multiloba, 71; racemosa, 15, 16, 71; sp., 21, 71.
- Craig Christie, A., on the Occurrence of *Stipules in Ilex Aquifolium*, 467.
- Cranichis, 341; parvilabris, 342.
- Craniospermum parviflorum, 80.
- Crassula dependens, 391; sp., 57.
- Crassulacæ (Afghan), 57; of Madagascar, 268.
- Cratægus oxyacantha, 16, 56, 376.
- Cratæva religiosa, 374.
- Cremastra, 318.
- Crepis Kotschyana, 73; sp., 73.
- Crucianella glomerata, 66.
- Crucifera (Afghan), 33.
- Crybe, 348.
- Cryptangiæ, 366.
- Cryptangium, 366.
- Cryptarrhena, 329.
- Cryptocentrum, 325.
- Cryptochilus, 303, 307.
- Cryptocoryne auriculata, 245; bulbosa, 245; caudata, 242; ciliata, 245; cordata, 243; Dalzellii, 244; ferruginea, 245; Griffithii, 244; lingua, 245; longicauda, 245; pallidinerxia, 245; spathulata, 245; striolata, 245.
- Cryptocoryminæ, 242.
- Cryptoglottis, 338.
- Cryptogramma crispa, 12, 111.
- Cryptomeria, 475, 476; japonica, 483, 497, 481, vars. araucarioides, 498, dacrydioides, 498, elegans, 497, 498, Lobbi, 498, macrocephala, 498, nana, 498, pungens, 498, pygmæa, 498, spiralis, 498, torta, 498, variegata, 498, viridis, 498.
- Cryptopus, 336.
- Cryptosaccus, 328.
- Cryptostegia, 348.
- Cryptostylis, 347.
- Cucubalus bacciferus, 375.
- Cuculla, 332.
- Cucumis Melo, 60.
- Cucurbitacæ (Afghan), 60.
- Cunninghamia, 476, 502; lanceolata, 502; sinensis, 484, 502.
- Cunninghamites, 484, 502.
- Cupressites, 483.
- Cupressus, 496; Corneyana, 496; funebris, 481, 483, 496; japonica, 497; nutkaensis, 478; obtusa, 478, 492; pendula, 496; pisifera, 478, 499; sempervirens, 14, 97, 139; squarrosa, 490; thuyoides, 478.
- Cupuliferæ (Afghan), 95.
- Cuscuta Epithimum, 82; planiflora, 82.
- Cuttings, theory growth of, 406.
- Cyathoglottis, 340.
- Cyathus desertorum, 387; fumicola, 387; pezizoides, 387; pusio, 387.
- Cybele, 354.
- Cyclopogon, 343.
- Cynoches, 322, 323.
- Cylindrochilus, 332.
- Cylindrolobus, 303.
- Cylindrospermum cæruleum, 126; janthium, 126; riparium, 126.
- Cymbella obtusiuscula, 130; pusilla, 130; scotica, 130, 132; turgida, 132.
- Cymbidiæ, 287, 317.
- Cymbidium, 317; cochleare, 318; elegans, 318; giganteum, 318; Huttonii, 318; Mastersii, 318; Sanderonii, 317.
- Cynanchium humile, 79.
- Cynodon Dactylon, 108.
- Cynoglossum furcatum, 80; glochidiatum, 80.
- Cynorchis, 352, 353, 366; squamata, 357.
- Cyperacæ (Afghan), 104.
- , notes on, by G. Bentham, 360.
- Cyperorchis, 318.

- Cyperus, 365; *flavescens*, 104; *longus*, 104.
 Cyripediæ, 285, 286, 289, 358.
 Cyripedium, 284, 359, 360.
 Cyrtopera, 320; *flava*, 320; *foliosa*, 320; *plantaginea*, 320; *Woodfordi*, 320.
 Cyrtopodiæ, 288, 316, 319, 323.
 Cyrtopodium, 319, 320; *Andersonii*, 320.
 Cytosia, 340.
 Cystopteris *fragilis*, 11, 20, 22, 111, *var. dentata*, 111.
 Cystopus, 345.
 Cystorchis, 344; *obscura*, 344.
 Cytheris, 305.
 Cytisus, 140.

 Dactylostyles, 329.
 Dædalea *intermedia*, 385.
 Dalbergia *sisso*, 5.
 Daphne, 6, 10, 14, 15, 16, 18; *Gnidium*, 140; *oleoides*, 6, 25, 91.
 Darwin, F., the Theory of the Growth of Cuttings, illustrated by Observations on the Bramble, *Rubus fruticosus*, 406.
 —, on the Power possessed by Leaves of placing themselves at Right Angles to the Direction of Incident Light, 420.
 Dasylirion *acrotichum*, 238, 239; *Berlandieri*, 238, 240; *glaucophyllum*, 238, 239; *graminifolium*, 238, 239; *Hookeri*, 238, 240; *pitcairniæfolium*, 241; *plabile*, 238, 240; *quadrangulatum*, 238, 240; *serratifolium*, 238, 240; *texanum*, 238; *Wheeleri*, 238, 239.
 Date-Palm of Riviera, 144.
 Datura, 26; *Stramonium*, 83.
 Daucus *carota*, 64.
 Delphinium *Brunonianum*, 21, 25, 31, 375; *denudatum*, 374; *sp.* (near *tuberosum*), 31; *uncinatum*, 31; *vestitum*, 375.
 Dendrobieæ, 287, 296.
 Dendrobium, 296, 302, 333; *bifalceæ*, 332.
 Dendrochilum, 295, 296, 301; *glumaceum*, 295.
 Dendrocolla, 332.
 Dendrolirion, 303.
 Dendrolirium, 303.
 Dendrophylax, 337.
 Depazea *maculosa*, 462.
 Deræmeria, 354, 356.
 Desmidiæ of Amazons, 128.
 Desmodium *oxybracteum*, 267; *Scalpe*, 267; *tibiæfolium*, 10, 49.
 Desmogonium *guianense*, 130, 131, 132.
 Deutzia, 376.
 Deyeuxia *sp.*, 107.
 Diacrium, 312, 313.
 Diadenium, 325.
 Diademsis *confervaceæ*, 130.
 Dialissa, 292.
 Dianthus *crinitus*, 36; *fimbriatus*, 36; *sp.?*, 36.
 Diarthron *carinatum*, 92.
 Diatoma *elongatum*, 131.
 Diatomaceæ, 129.
 Dichæa, 324, 331, 337.
 Dichætanthera *madagascariensis*, 270.
 Dichostyles, 362.
 Dichromena, 365.
 Dichrostachys *tenuifolia*, 268.
 Dickie, Prof. G., Notes on Algæ from the Amazons and its Tributaries, 123.
 Dicrypta, 324.
 Didactyle, 298; *exalata*, 299; *meriden-sis*, 299.
 Dienia, 293.
 Digitaria *sanguinalis*, 106.
 Diglyphosa, 302.
 Dignathe, 326.
 Dilochia, 309.
 Dinemia, 314.
 Dionysia *tapetodes*, 11, 17, 78.
 Dioscorea *deltoides*, 10, 101.
 Dioscoreaceæ (Afghan), 101.
 Diospyros, 24; *Lotus*, 9, 78.
 Diothonia, 310.
 Dipcadi *Bakerianum*, 394.
 Diplacrum, 266.
 Diplecthrum, 357.
 Diplocentrum, 335.
 Diplochilus, 356.
 Diplogastræ *angolensis*, 346.
 Diplomeris, 352, 356.
 Dipodium, 318.
 Dipsacaceæ (Afghan), 66.
 Disa, 357.
 Disæ, 288, 357.
 Disella, 357; *graminifolia*, 357.
 Disperis, 358.
 Dissorhynchium, 355.
 Distichis, 294.
 Diuridæ, 288, 346.
 Diuridæ, 339.
 Docidium *minutum*, 129.
 Dodonæa, 6; *viscosa*, 41.
 Doritis, 332.
 Dossinia, 345.
 Draba *sp.*, 13, 20, 22, 33, 34.
 Dracocephalum *sp.*, 87.
 Dracunculus *canariensis*, 262; *vulgaris*, 262.

- Drosera ramentacea*, 269.
Drymoda, 296, 300.
Dryoepia, 358.
- Earina*, 285, 307.
 Ebenaceæ (Afghan), 78.
Ebenus stellata, 5, 8, 48.
Eborilingues, Reichb., 318, 322.
Ecballium Elaterium, 144.
Echinolytrum, 362.
Echinosperrum barbatum, 80; *Lappula*, 80.
Echioglossum, 335; *muticum*, 335.
Eclipta alba, 69.
Eglanteria, 9.
Ehretia aspersa, 4.
 Elægnaceæ (Afghan), 92.
Elægnus, 7, 9, 15; *angustifolia*, 92, var., 92; *parvifolia*, 92.
 Elasticæ (sect.), 114, 118.
Elleanthus, 306, 307, 309.
Elymus excelsus, 110.
Elyna, 367.
Elynanthus, 361; *compar*, 362.
Encyclia, 313, 314.
Ephedra sp., 5, 17, 97.
Ephippianthus, 294.
Epicladium, 313.
Epicranthes, 298.
Epidendræa, 284, 285, 286, 287, 289, 290, 302, 338, 339.
Epidendrum, 285, 310, 313, 327, 336; *basilare*, 314; *bicornutum*, 312; *cycnostachys*, 314; *diffusum*, 310; *hexandrum*, 338; *nævosum*, 314; *Stamfordianum*, 314; *tridactylum*, 310.
Epilobium angustifolium, 60, var. *brachycarpum*, 60; *hirsutum*, var. *sericeum*, 60; *roseum*, 60; sp., 60; *tetragonum*, 60.
Epipactis, 143, 284, 349; *veratrifolia*, 13, 100.
Epiphanes, 348, 349.
Epipogon, 347, 349.
Epistephium, 299, 339, 340, 347.
Epithecium, 314.
 Equisetaceæ (Afghan), 113.
Equisetum, 145; *elongatum*, 113.
Equitantia, 328.
Eragrostis pœoides, var., 108.
Eremostachys, 6; sp., 88; *speciosa*, 77, 89.
Eremurus Aitchisoni, 102; *aurantiacus*, 16, 24, 102; sp., 18, 19.
Eria, 285, 294, 302, 303, 304, 307; *extinctoria*, 300; *lichenora*, 303; *Parishii*, 303; *ustulata*, 303.
Eriaxis, 340.
Erica arborea, 140.
 Ericaceæ (Afghan), 75.
Ericinella passerinoides, 393.
Eriæ, 287, 290, 291, 296, 302.
Erigeron acris, var. *alpina*, 68; *andryaloides*, 68; *monticola*, 68; *multiradiatus*, 68.
Eriocaulon, 364.
Eriochilus, 285.
Eriophora, 364.
Eriophorum, 363.
Eriopsis, 321.
Eriospora, 361, 367.
Eritrichium sericeum, 13, 80.
Eriura, 303; *acridostachya*, 303; *barbata*, 303; *rosea*, 303; *stellata*, 303.
Erodium cicutarium, 39.
Ervum Ervilia, 15, 49.
Erycina, 337, 328.
Eryngium Billardieri, 60; *cæruleum*, 60.
Erysimum repandum, 34; sp.?, 34.
Erysiphe, 461; *scandens*, 463.
Erythorchis, 340.
Erythræa, on a, new to England, by F. Townsend, 398.
 — *capitata*, 398, 399, 401, 402, vars. α . *Willdenowiana*, 433, β . *sphærocephala*, 403, 405; *centaurium*, 79, 398, 400, 401, 402, var. β . *capitata*, 400, 401, 405, var. *fasciculata*, 400, var. *suffruticosa*, 401; *chloodes*, (ftnote) 402; *latifolia*, 400; *linarifolia*, 398; *littoralis*, 398, (ftnote) 401; *pulchella*, 398, 404; *ramosissima*, 16, 79.
Erythrodes, 344.
Esmeralda, 332.
Etaeria, 346.
Eualoe (subg.), 153.
Euastrum cuneatum, 128; *quadratum*, 128; *sinuosum*, 128.
Eu-Begonia (subg.), 117.
Eubletia, 305.
Eucalyptus globulus, 144; in the Riviera, 145.
Euclidium syriacum, 35; *tartaricum*, 35.
Eucnemis, 320.
Eucosia, 346.
Eudendrobium, 297.
Euepidendrum, 314.
Eulophia, 316, 334; *cochleata*, 320; *herbacea*, 317.
Eulophiæ, 287, 316.
Eunotia camelus, 130; *declivis*, 129; *diodon*, 129; *enneodon*, 129; *formica*, 130; *hendecaodon*, 129; *hep-*

- todon, 129; monodon, 129; nodosa, 129; quaternaria, 129; quinararia, 129; sella, 129; septena, 129; tetraodon, 129; triodon, 129; zygodon, 129.
- Euonymus fimbriatus*, 11, 40; *Hamil-tonianus*, 374.
- Euothonea*, 310.
- Euphais*, 305.
- Euphorbia Chamaesyce*, 92; *dendroides*, 141; *falcata*, 93; *Gerardiana*, 93; *primulæfolia*, 278; sp., 25, 93; *spinosa*, 140; *Szovitzii*, 93.
- Euphorbiaceæ* (Afghan), 92.
- Euphrasia officinalis*, 84.
- Euproboscis*, 338.
- Eu-Platycentrum* (sect.), 119.
- Euspiranthes*, 343.
- Euyucca* (subg.), 220.
- Evelyna*, 309.
- Fernandezia*, 330, 331.
- Ferula Jaeschkiana*, 19, 25, 63.
- Festuca duriuscula*, var. *violacea*, 109; *elatior*, 109, var. *minor*, 109; *ovina*, 21, 109.
- Ficinia*, 364.
- Ficus caricoides*, 7, 94; *Carica*, 94.
- Fieldia*, 331.
- Filago arvensis*, 68.
- Filices* (Afghan), 111.
- Fimbristylis*, 362.
- Fintelmannia*, 366.
- Flora of Kuram Valley, 1.
- : *Badishkhél* to Kuram, veget. of, 6; *Badishkhél* to *Péwárkotal*, 3; conformation of country gen., 2; flanks of *Safed Koh*, 8; fodder for animals, 25; forests, 26; gen. observ., 1; *Hariáb* district, 15; indigenous plants as food, 24; *Karaia* to *Hazár-darakht*, 4; *Kuram* plains, veget. of, 7; Medicinal products, 25; plants cultivated for food, 22; *Shálizán* to *Péwárkotal*, veget. of, 13; *Síkarám* and spurs, 17, 20; *Thal* to *Badishkhél*, 3, veget. of, 4; valleys of *Safed Koh*, 10, 12.
- Flowering Plants of Madagascar, 264.
- Fœniculum vulgare*, 62.
- Forficaria*, 358.
- Fornicaria*, 332.
- Fothergilla*, 11, 27; *involuta*, 10.
- Fragaria indica*, 52; *vexa*, 52.
- Fraxinus*, 27, *excelsa*, 376; *Moorcroftiana*, 14, 17, 79, 376.
- Fregea*, 340.
- Fritillaria imperialis*, 16, 102.
- Fumaria parviflora*, 32.
- Fumariaceæ* (Afghan), 32.
- Fungi*, *Afghan*, 113; *Australian*, 383.
- Gabertia*, 318.
- Gagea*, 16; *fliformis*, 101; *lutea*, 101; *reticulata*, 101; *setifolia*, 101, var., 102; *thesioides*, 102.
- Galeandra*, 316, 317.
- Galeoglossum*, 342.
- Galeola*, 339, 340; *altissima*, 340; *cas-sythoides*, 340; *foliata*, 340; *javanica*, 340; *Lindleyana*, 340; *septentrionalis*, 340.
- Galeottia*, 320.
- Galera*, 349.
- Galium Aparine*, 65; *asperifolium*, 65; *tricornis*, 65.
- Gamoplexis*, 349.
- Gasteria acinacifolia*, 184, 196, vars. *ensifolia*, 196, *nitens*, 196; *apicroides*, 184, 197; *Bayfieldii*, 184, 197; *bicolor*, 183, 188; *brevifolia*, 183, 186; *candicans*, 184, 196; *carinata*, 183, 192; *cheilophylla*, 183, 189; *colu-brina*, 183, 190; *crassifolia*, 185; *Croucheri*, 184, 196; *decipiens*, 183, 192; *dicta*, 183, 189; *disticha*, 183, 186, vars. *angulata*, 187, *angustifolia*, 187, *conspurcata*, 187, *minor*, 187, *natalensis*, 187; *excavata*, 183, 188; *excelsa*, 184, 195; *fuscopunctata*, 183, 195; *glabra*, 183, 194; *gracilis*, 183, 193; *lætepunctata*, 183, 193; *linita*, 196; *maculata*, 183, 191, var. *fallax*, 192; *marmorata*, 183, 194; *mollis*, 183, 187; *nigricans*, 182, 185, vars. *fasciata*, 185, *guttata*, 185, *platyphylla*, 186, *polyspila*, 185, *subnigricans*, 186; *nitida*, 183, 195, var. *grandipunctata*, 195; *obtusata*, 183, 194; *obtusifolia*, 183, 186; *palles-cens*, 183, 190; *parva*, 192; *parvi-folia*, 183, 193; *Peacockii*, 183, 195; *pethamensis*, 183, 193; *picta*, 183, 191, var. *formosa*, 191; *planifolia*, 183, 188; *pluripuncta*, 196; *por-phyrophylla*, 183, 190; *pulchra*, 183, 191; *repens*, 182, 185; *relata*, 183, 189; *spiralis*, 183, 189, var. *tortu-lata*, 189; *squarrosa*, 184, 197; *stri-gosa*, 193; *subcarinata*, 183, 192; *subverrucosa*, 182, 184, vars. *parvi-punctata*, 185, *marginata*, 185; *sul-cata*, 183, 187; *trigona*, 183, 194; *variolosa*, 183, 190; *venusta*, 196; *verrucosa*, 182, 184, vars. *latifolia*, 184, *intermedia*, 184, *scaberrima*, 184; *Zeyheri*, 183, 190.
- Gastrodia*, 349.
- Gastroglottis*, 295; *montana*, 295.
- Gastropodium*, 310.
- Gastroorchis*, 305.
- Gazania cespitosa*, 393.

- Geaster hygrometricus*, 386; lignicola, 386.
Genista, 140.
Gennaria, 354.
Gentiana aquatica, 16, 79; sp. ? , 375.
 Gentianaceæ (Afghan), 79.
Geodorum, 318.
Georchis, 345.
 Geranaceæ (Afghan), 39.
Geranium, 374; *divaricatum*, 374, 380; *grandiflorum*, 380; *lucidum*, 373; *nepalense*, 12, 39; *ocellatum*, 373; sp., 16, 39, and white var. of, 39; *Wallichianum*, 12, 25, 39.
Gerbera podophylla, 272.
Gethyllis longistyla, 396.
Geum urbanum, 52.
Ghiesbreghtia, 308.
Gingko, 475, 476, 481, 484, 500; *biloba*, 481, 500.
Gladiolus segetum, 143.
Glaucium fimbriigerum, 32.
Glaux maritima, 16, 78.
Globularia Alypum, 140.
Gleotila aurea, 124; *nigrescens*, 124.
Glomera, 307.
Glossaspis, 357.
Glossula, 352, 357.
Glycine Soja, 15, 50.
Glycyrrhiza glandulifera, 48.
Glyptostrobos, 481; *heterophyllus*, 498; *pendulus*, 498.
Gnaphalium crispatum, 69; *luteoalbum*, var., 69.
 Gnetaceæ (Afghan), 97.
Gomesa, 326, 327, 329.
Gomphia deltoidea, 265.
Gomphichis, 341, 342.
Gomphocentrum, 337.
Gomphonema anglicum, 130; *coronatum*, 130; *cristatum*, 130, 131; *dichotomum*, 130; *hebridense*, 132; *lagenula*, 131; *lanceolatum*, 130, 131, 132; *subtile*, 131; *turris*, 132, var. *apiculatum*, 130; *vibrio*, 130, 132.
Gonatozygon Ralfsii, 128.
Gongora, 322.
Gonialoe (subg.), 155.
Goodyera, 344, 345; *fumata*, 346; *macrophylla*, 346; *procera*, 345; *pusilla*, 345; *repens*, 100; *guianensis*, 345; *Wrightii*, 345.
Govenia, 319, 320.
Govindovia, 341.
 Gramineæ (Afghan), 105.
Grammangis, 318.
Grammatophyllum, 318; *Ellisii*, 318.
Grandinia granulosa, var. *ochracea*, 385; *ocellata*, 385.
Grewia oppositifolia, 372.
Grobya, 320.
Grosourdia, 332.
Gunnia, 333.
Gussonia, 337.
Gymnadenia, 353, 354; *Chusia*, 355; *pinguicula*, 355; *spathulata*, 355.
Gymnandra arenaria, 7; *stolonifera*, 15, 85.
Gymnochilus, 346.
Gymnosporia spinosa, 4.
Gymnothrix flaccida, var., 106.
Gypsophila alsinoides, 36; *cerastioides*, 373; *floribunda*, var. β , 36; *sedifolia*, 22; sp. ? , 6, (near *sedifolia*), 37; *Stewartii*, 7, 19, 36.
Gyrostachys, 342.
Habenaria, 284, 351, 352, 353, 356; *albida*, 354; *aphylla*, 354; *attenuata*, 355; *Conopsea*, 354; *cordata*, 354; *Heyneana*, 355; *intacta*, 354; *lutea*, 354; *nigra*, 354; *nivea*, 354; *obtusata*, 355; *odoratissima*, 354; *tipuloidea*, 355; *tridentata*, 354; *viridis*, 354.
Habenariæ, 288, 352.
Hæmaria, 345.
Hæmatorchis, 340.
Hallachia, 353.
Halleria ligustrifolia, 273.
Haloschæni, 365.
Hamamelidæ (Afghan), 59.
Hantzschia brasiliensis, 131.
Haplochilus, 345.
Hartwegia, 313.
Haworthia affinis, 199, 213; *albicans*, 199, 207; *altilinea*, 199, 209; *angolensis*, 199, 210; *angustifolia*, 199, 210; *arachnoides*, 200, 215; *asperiuscula*, 198, 200; *asperula*, 199, 208; *attenuata*, 198, 203, var. *clariperla*, 204; *atrovirens*, 199, 212; *bilineata*, 199, 213; *Bolusii*, 200, 215; *chlorocantha*, 199, 211; *coarctata*, 198, 202; *Cooperi*, 199, 215; *cordifolia*, 198, 200; *curta*, 201; *cuspidata*, 199, 209; *cymbiformis*, 199, 209, vars. *obtusa*, 209, *planifolia*, 209; *denticulata*, 199, 213; *fasciata*, 198, 204; *glabrata*, 199, 206, vars. *concolor*, 206, *perviridis*, 206; *glauca*, 198, 203; *Greenii*, 198, 202; *hybrida*, 198, 203; *icosiphylla*, 199, 207; *latevirens*, 199, 212; *margaritifera*, 199, 204, vars. *corallina*, 205, *erecta*, 205, *granata*, 205, *semimargaritifera*, 205; *minima*, 199, 215; *mirabilis*, 199, 212; *multifaria*, 212; *mutica*, 199, 209; *nigra*, 198, 203; *pallida*, 199, 214; *papillosa*, 198, 201, var. *semipapil-*

- losa, 202; Peacockii, 198, 202; pili-
 fera, 199, 214; polyphylla, 199, 213;
 Radula, 199, 206; ramifera, 207;
 recurva, 199, 208; Reinwardtii, 198,
 202; reticulata, 199, 210; retusa,
 199, 208; rigida, 198, 203; rugosa,
 199, 206; scabra, 199, 207; semi-
 glabrata, 199, 205; setata, 200, 216;
 sordida, 199, 207; subalata, 199,
 206; subattenuata, 199, 205; sub-
 fasciata, 198, 204; subregularis, 199,
 212; subrigida, 198, 201; tessellata,
 199, 211, vars. parva, 211, inflexa,
 211; Tisleyi, 199, 208; tortella,
 201; tortuosa, 198, 201, var. major,
 201; translucens, 199, 214; turgida,
 199, 209; venosa, 199, 211; vires-
 cens, 207; viscosa, 198, 200, vars.
 concinna, 200, indurata, 200, pseudo-
 tortuosa, 201; torquata, 201; vittata,
 199, 214.
- Hechtia glomerata, 241.
 Hedera Helix, 10, 64.
 Hedysarum astragaloides, 49.
 Helcia, 326.
 Helecharis, 363; palustris, 104.
 Heleophylax, 362.
 Helianthemum, 141.
 Helicodicerus crinitus, 262.
 Helicophyllum angustatum, 262; cras-
 sipes, 262; Olivieri, 262.
 Heliotropium europæum, 80; sp., 80.
 Helvella crispa, 24, 113.
 Hemicarex, 366, 367.
 Hemileia vastatrix, 461.
 Hemipilia, 352, 357.
 Hemiscleria, 310.
 Hemlock Spruces of Japan, 477.
 Henslow, the Rev. G., on a Proliferous
 Condition of *Verbascum nigrum*, L.,
 455.
 Heracleum sp. (near *candicans*), 63.
 Herminium, 352, 353; alpinum, 352;
 Monorchis, 352; reniforme, 353.
 Herniaria hirsuta, 89.
 Herreria Salsaparilha, 232, var. inter-
 rupta, 232; montevidensis, 232;
 stellata, 232.
 Herpolirion capense, 395.
 Herpysma, 344.
 Herschelia, 357.
 Hesperaloe Engelmanni, 231; yuccæ-
 folia, 231.
 Hesperoyucca (subg.), 221.
 Hetæria, 344, 345, 346.
 Heterotaxis, 324.
 Hexadesmia, 310, 311.
 Hexalectris, 296, 305.
 Hexameria, 338.
 Hexisia, 310, 311.
- Hibiscus Trionum, 39.
 Hildebrandia, 114.
 Himalayan Vegetation, Dr. G. Watt
 on, 368.
 Himantidium gracile, 130, 132; majus,
 131; pectinale, 130.
 Hippophaë, 15; rhamnoides, 92.
 Hirneola Lesuerii, 386; rufa, 386.
 Hofmeisterella, 329.
 Holmes, E. M., on *Codiolum gregarium*,
 132.
 Holothrix, 352, 353.
 Homotrichum flaccum, 134.
 Hoppia, 366, 367.
 Hordeum caducum, 19, 110; hexasti-
 chum, 110; murinum, 110; vulgare,
 var., 110.
 Hormidium, 310, 313.
 Houletia, 322.
 Huntleya, 320; meleagris, 321.
 Huttonæa, 352, 353.
 Hydnum coralloides, 24, 113.
 Hydrocoleum thermale, 126.
 Hydrostachys goudotana, 279; imbri-
 cata, 279; verruculosa, 279.
 Hylophila, 345.
 Hymeneria, 303.
 Hymenochæte, 363; rubiginosa, 386.
 Hyoscyamus, 26; niger, 15, 83; pusillus,
 19, 83; reticulatus, 19, 83.
 Hypecum procumbens, 32.
 Hypericinæ (Afghan), 38.
 Hypericum, 374; perforatum, 38;
 scabrum, 38; sp.?, 38.
 Hypheothrix cyanea, 127; laminosa,
 127; lateritia, var. kermesina, 127;
 lutescens, 127; olivacea, 127; ther-
 malis, 127; tenuissima, 127; vulpina,
 127.
 Hypodematium, 317.
 Hypoelytrum, 361, 362, 365.
 Hypolepis, 361.
 Hypolytræe, 365.
 Hypopithys lanuginosa, 17, 76.
 Hysteria, 341.
- Ianthé, 329; pulchella, 329.
 Ibidium, 342.
 Ilex aquifolium, occurrence of Stipules
 in, 467; Godajam, 467.
 Illicinæ, Stipules in, 467.
 Illecebracæ (Afghan), 89.
 Impatiens amphorata, 12, 39, 373; sp.,
 40; sp. (near *I. racemosa*), 40.
 Imperata cylindracea, 111.
 Inactis fasciculata, 126; obscura, 126.
 Indian Begonias, C. B. Clarke on, 114.
 — Coffee-leaf Disease, remarks on,
 by W. Bidie, 458.
 Indigofera Bojeri, 266; Gerardiana,

- 10, 43; leucoclada, 267; purpurea, 372.
Inga sp., 424.
Inoderma arenarium, 386; *ingratissimum*, 386.
Inula Caspia, 69; *rhozocephaloides*, 21, 69.
Ione, 298; *paleacea*, 298.
Ionopsis, 329.
Ipomœa Nil, 81.
Ipsa, 304.
 Iridacæ (Afghan), 100.
Iridorchis, 317.
Iris ensata, 100; *Guldenstædtiana*, 100; *pallida*, 9, 100.
Isaria fuciformis, 388.
Isatis tinctoria, 8, 16, 19, 26, 35.
Ischæmum hirtinodes, 111.
Isias, 352.
Isochilus, 312; *linearis*, 312.
Isolepis, 362.
Isopyrum anemonoides, 30; *grandiflorum*, 12, 31, and var., 31; *thalictroides*, 20.
Ixiolirion montanum, 100.
- Jainia*, 303, 306; *speciosa*, 306.
 Japan, Conifers of, 473, 475.
Jasminum fruticans, 140; *Kitchingii*, 272; *officinale*, 10, 78; *revolutum*, 10, 78.
Josephia, 307.
 Juglandacæ (Afghan), 95.
Juglans regia, 95, 374.
 Juncacæ (Afghan), 104.
 Juncaginacæ (Afghan), 99.
Juncus compressus, 104; *glaucus*, 104, var., 104.
Juniperites, 483.
Juniperus, 476; *barbadensis*, 497; *chinensis*, 483, 497; *communis*, 13, 19, 20, 40, 97, 483, 496, 497, var. *nana*, 483; *conferta*, 483, 496; *davurica*, 483, 497; *ericoides*, (ftnote) 495; *excelsa*, 11, 13, 14, 16, 18, 19, 20, 28, 97, 376; *japonica*, 497; *latifolia*, 496; *littoralis*, 496; *meldensis*, (ftnote) 495; *nana*, 477; *nipponica*, 477, 483, 496; *occidentalis*, 483; *Oxycedrus*, 140; *procumbens*, 497; *pseudo-Sabina*, 483; *rigida*, 483, 496; *Sabina*, 483; sp., 97; *sphærica*, 483; *taxifolia*, 483, 496; *virginiana*, 483, (ftnote) 495; *virginica*, 497.
- Kefersteinia*, 320.
Kegelia, 322.
Keteleeria Fortunei, 522.
- Kigelia madagascariensis*, 274.
 Kitching, L., Collection of Flowering Plants made in Madagascar, 264.
Kitchingia campanulata, 269; *gracilipes*, 268.
 Klinostat, *descript.* of, 449.
Kobresia, 366, 367; *Hookeri*, 367; *laxa*, 367; *reticularis*, 367; *scirpina*, 104.
Kœleria cristata, 21, var. *glaberrima*, 109; *phleoides*, 109.
Koellensteinia, 320.
Kœlpinia linearis, 73.
 Kuram Valley, Flora of, 1.
- Labiatae* (Afghan), 85.
Lacœna, 321.
Lactuca auriculata, 73; *orientalis*, 16, 73; *rapunculoides*, 73; sp., 73; *virminæa*, 16, 73.
Lœlia, 312, 314.
Lœliæ, 287, 296, 311.
Lœliopsis, 312, 314.
Lagenocarpus, 366.
Lagerstrœmia madagascariensis, 270.
 Lahoul, British, Notes on the Vegetation of, 368.
Lallemantia Royleana, 87.
Lamium, 310, 313; *amplexicaule*, 88; *rhomboideum*, 20, 21, 88.
Lantana sp., 85.
 Larches of Japan, 477.
Laricites, a fossil Conifer, 524.
Larix, 476; *Americana*, 524; *Archangelica*, 523; *davurica*, 485, 522; *decidua* γ . *americana*, 524, β . *rossica*, 523; *europæa sibirica*, 523; *Fraseri*, 524; *intermedia*, 524; *japonica*, 523; *Kæmpferi*, 485, 523, var. β . *nana*, 523; *Ledebourii*, 523; *leptolepis*, 485, 522; *microcarpa*, 524; *pendula*, 485, 523; *sibirica*, 485, 523.
- Lasiagrostis Jacquemontii*, 107; sp., 107.
Lasiolepis, 364.
Lathrodes, 345.
Lathyrus Aphaca, 50; *sphæricus*, 50.
Latourea, 297.
Laurus nobilis, 138.
Lavandula Stœchas, 140.
Lavatera maritima, 143.
 Leaves, power of placing themselves at right angles to Light, F. Darwin on, 420.
Lecanorchis, 346.
Ledgeria, 340.
 Leguminosæ (Afghan), 42.
Leiochilus, 327, 328.
Lemaniacæ, 123.

- Lentinus Guilfoylei*, 384; *lateritus*, 384.
Leontopodium, 21; *alpinum*, 68.
Leonurus Cardiaca, 88.
Leopardanthus, 318.
Lepanthes, 292.
Lepidium Draba, 34; *latifolium*, 34.
Lepidogyne, 346.
Lepidospermum, 364.
Leptorhabdos sp. (near *virgata*), 17, 84.
Leptotes, 314.
Lespedeza sericea, 49.
Leucohyle, 326.
Leucorchis, 348, 354.
Leucoetachys, 345.
Leucothoe littoralis, 272.
Libocedrus, 485; *decurrens*, 483; growth leaves of, 482; *macrolepis*, 483, 485.
Lichenora, 302.
Ligularia persica, 70.
Ligurian Riviera, Vegetation of, 135.
Ligusticum, 20, 21, 62.
Liliaceæ (Afghan), 101.
Lilium polyphyllum, 21; var., 103.
Limatodes, 305; *gracilis*, 305; *rosea*, 305, 309.
Limnanthemum indicum, 273.
Linnochloa, 363.
Limnodietyon obscurum, 125.
Limodoreæ, 288, 339, 349.
Limodorum, 336, 349.
Linaria Elatine, monstrosity of, (ftnote) 456; *venosa*, 83.
Linææ (Afghan), 39.
Lindblomia, 354.
Linum maritimum, 143; *narbonensis*, 143; *perenne*, 21, 39; *viscosum*, 143.
Liparidææ, 287, 291, 293, 294.
Liparis, 285; *ramosa*, 294, 295, 301; sp., 100.
Lipocarpa, 361.
Lissochilus, 317.
Listera, 341, 342.
Listrostachys, 336.
Lithospermum arvense, 81; *officinale*, 81, var., 81.
Lockhartia, 330, 337.
Loganiaceæ (Afghan), 79.
Lolium, 26; *perenne*, 109, var. *aristata*, 110; *temulentum*, 23, 110.
Lonicera, 376; *alpigena*, 64; *glauca*, 20, 64; *Griffithii*, 14, 17, 19, 64; *microphylla*, 65; *Myrtillus*, 65; *obovata*, 65; *orientalis*, 65; *quinquelocularis*, 10, 28, 65; *sericea*, 12, 65.
Loranthaceæ (Afghan), 29.
- Loranthus hoyesifolius*, 277; *lenticellatus*, 278.
Loroglossum, 351, 352.
Lotus corniculatus, 43.
 Lower Lahoul, notes on, 370.
Ludisia, 345.
Luisia, 284, 331; *bicaudata*, 331.
Lycaste, 322.
Lychnis indica, var. *fimbriata*, 37; sp. near *L. macrorrhiza*, 37.
Lycormium, 321.
Lycopodiaceæ (Afghan), 113.
Lyngbya arachnoidea, 127; *guayanensis*, 127; *putealis*, 127; *rufescens*, 127.
Lyræa, 299.
Lysimachia dubia, 78; *Ephemerum*, monstrous condition of, 455.
Lythraceæ (Afghan), 59.
- Macodes*, 346.
 MacOwan, P., and Bolus, H., *Novitates Capenses: Descriptions of New Plants from the Cape of Good Hope*, 390.
Macradenia, 338.
Macrocentrum, 355.
Macrostrom, 297.
Macrostyles, 341.
Macrothuya, 486.
Macrotomia, dimorphism of, 524; *Benthami*, 524; *perennis*, 524, 525; sp., 21.
Macroura, 335, 336.
 Madagascar, Flowering Plants of, 264.
Mæsa lanceolata, 272.
Malaxææ, 291.
Malaxidææ, 284, 285, 286, 289, 290, 302.
Malaxis, 284, 293, 294; *paludosa*, 293.
Malcolmia africana, 34.
Malva rotundifolia, 39.
Malvaceæ (Afghan), 39.
Mancha de hierro (or Coffee-disease), 462.
Marasmius equicrinis, 383; *exocarpis*, 384; *lignyodes*, 384; *Muelleri*, 383.
 Maritime Alps, plants of, 135.
Marrubium vulgare, 88.
Masdevallia, 291; *fenestrata*, 292.
 Masters, Maxwell T., on the Conifers of Japan, 473.
Matricaria disciformis, 16, 69; *suaveolens*, 69.
Matthiola incana, 143.
Maxillaria, 321, 323, 324, 331.
Maxillaridææ, 322.
Maxillariææ, 288, 323.
Meconopsis aculeata, 375.

- Mecosa*, 355.
Megaclinium, 300.
Meiracyllium, 293.
Melia Azedarach, 5, 6, 9, 40, 374.
Meliaceæ (Afghan), 40.
Melica sp., 108; *Jacquemontii*, 108, var. *purpurea*, 109.
Melilotus alba, 43; *lupulina*, 43; *officinalis*, 43; *sativa*, 43.
Melosira californica, 130; *subflexilis*, 130; *varians*, 130, 131.
Mentha incana, 86.
Merendera persica, 15, 103.
Merulius aureus, 385.
Mesoclastes, 331.
Mesospinidium, 327, 328, 329.
Meziera, 114.
Micrasterias crux-melitensis, 128; *didymacantha*, 128; *furcata*, 128; *laticeps*, 128.
Microchilus, 344.
Microcœlia, 337.
Microcystis cœrulea, 128; *lobata*, 128; *olivacea*, 128.
Micromeria biflora, 86.
Micropera, 333.
Microrhynchus asplenifolius, 19, 74; *secundus*, 74.
Microsaccus, 335.
Microstyleæ, 287, 293, 294.
Microstylis, 293, 294; *commelynifolia*, 295.
Microthamnion strictissimum, 123.
Miltonia, 327, 328.
Mimulopsis speciosa, 274.
Mitostigma, 355.
Mörenhoutia, 346; *plantaginea*, 346.
Monadenia, 357.
Monochilus, 345.
Monomeria, 300, 301.
Monotris, 353.
Monotropææ (Afghan), 76.
Moræa Sisyrrinchium, 7, 100.
Morchella conica, 113; *esculenta*, 24.
Moricandia arvensis, 142.
Morina Coulteriana, 66; *persica*, 66.
Mormia persica, 10.
Mormodes, 322.
Mormolyce, 323.
Morus albus, 5, 94.
Mougeotia sp.?, 125.
Mueller, Baron von, Australian Fungi described by the Rev. M. J. Berkeley, 388.
Murray, G., on the Application of the Results of Pringsheim's recent Researches on Chlorophyll to the Life of the Lichen, 147.
Musci (Afghan), 113.
Myanthia, 328.
Myanthium, 327.
Mycaranthus, 303.
Myllitta australis, 388.
Myoda, 345.
Myosotis sp., 375.
Myriactis Wallichii, 67.
Myricaria germanica, 38, 375.
Myrmechis, 344, 345; *glabra*, 345; *gracilis*, 345.
Myrosmodes, 341.
Myrsinaceæ, 468.
Myrtaceæ (Afghan), 59.
Myrtillus sp., 12.
Myrtus communis, 59, 140.
Mystacidium, 333, 336.
Nanodes, 314.
Nasonia, 331; *sanguinea*, 331.
Nasturtium officinale, 33, 370; *palustre*, 33.
Navenia, 321.
Navicula acuta, 130, 132; *affinis*, var. *tropica*, 131; *americana*, 130, 132; *amphiceros*, var. *parva*, 131; *amphirhynchus*, 130, 131; *angustata*, 131; *appendiculata*, 130, 131; *Bacillum*, 132; *bicapitata*, 131; *biceps*, 130; *binodis*, 131; *bohemica*, 130; *Brauniana*, 130; *Braunii*, 131; *Brebissonii*, 131, 132; *conops*, 131; *cryptocephala*, 130; *cuspidata*, 130; *dicephala*, 130; *dirhynchus*, 132; *exigua*, 130, 132; *firma*, 130, vars. *dubia*, 131, *tropica*, 131; *gibba*, 130, 131, 132; *gracillima*, 132; *Hilseana*, 131; *isoccephala*, 131; *lævisima*, 131; *lancoelata*, 130; *lata*, 130; *macilenta*, 130; *major*, 130, 131, 132; *mesolepta*, 130, 131; *mesostyla*, 131; *nodosa*, 131; *oblonga*, 130; *ovalis*, 132; *pachyptera*, 131; *Perrotettii*, 131; *pisciculus*, 131; *placentula*, 131; *rhomboides*, 130, 131, 132; *rhyngocephala*, 131, 132; *rupestris*, 130; *semilunum*, 131; *stauroptera*, 131; *subcapitata*, 130; *tabellaria*, 131; *termitina*, 130; *undosa*, 130; *viridis*, 130, 131, var. *commutata*, 131.
Nematogonum aureum, 388.
Nemochloa, 361, 362.
Neodryas, 327, 329.
Neogyne, 308.
Neotinea, 354.
Neottia, 341; *Lindleyana*, 342; *listeroides*, 342; *micrantha*, 342.
Neottiaæ, 285, 286, 288, 290, 337, 338.
Nepeta calaminthioides, 87; *discolor*, 87; *raphanorhiza*, 87; *rugosa*, 87; sp., 21, 87, (near *teucrifolia*) 17.
Nephelaphyllum, 305.

- Nephranthera*, 334.
Nephrodium barbigerum, 11, 112; *Brunonianum*, 11; *rigidum*, 11, 112, var. 112.
Nerium Oleander, 5, 141.
Nervilia, 348.
Neslia paniculata, 35.
Neuwiedia, 309, 360.
Nicotiana rustica, 83.
Nigritella, 354.
Nitzschia constricta, 130; *Davidsoni*, 131; *palea*, var. *tropica*, 131; *sigma*, 140; *thermalis*, 132; *Victorizæ*
Nomochloa, 362.
Nonnea nigricans, 81.
Nostoc lævigatum, 125.
Nostochaceæ, 125.
Notes on a Collection of Flowering Plants made by L. Kitching in Madagascar in 1879, by J. G. Baker, 264.
— Algæ from the Amazons and its Tributaries, by Prof. G. Dickie, 123.
— Cyperaceæ; with special reference to *Lestiboudois's* "Essai" on Beauvois's Genera, by G. Bentham, 360.
— Orchideæ, by G. Bentham, 281.
— the Vegetation &c. of Chumba State and British Lahoul, with Descriptions of new species, by G. Watt, 368.
Notiophrys Commelynæ, 346; *glandulosa*, 346.
Notylia, 338.
Notylicæ, 288, 327.
Novitates Capenses: Descriptions of New Plants from the Cape of Good Hope, by P. MacOwan and H. Bolus, 390.
Nymphæa stellata, 265.
Oberonia, 294, 304.
Octadesmia, 311, 314.
Octomeria, 292, 302; *serratifolia*, 311; *vaginata*, 303.
Odontidium tabellaria, 131.
Odontochilus, 345.
Odontoglossum, 326, 327, 328, 329; *crista-galli*, 328; *iridifolium*, 328; *onustum*, 328; *ramulosum*, 328; *roseum*, 327; *vexillare*, 327.
Odontostylis, 299.
Oeceoclades falcata, 334, 336; *maculata*, 334; *tenera*, 334.
Ædogoniaceæ, 124.
Ædogonium capillaceum, 124; *capillare*, var. *pannosum*, 124; *delicatum*, 124; *fasciatum*, 124; *scutatum*, 124.
Erstedella, 314.
Olea cuspidata, 5, 79.
Oleaceæ (Afghan), 78.
Olive of Riviera, notes on, 137.
Oliveriana, 326.
Ommatodium, 358.
Omphalodes sp., 80.
On an *Erythræa* new to England, from the Isle of Wight and South Coast, by F. Townsend, 398.
On a Proliferous Condition of *Verbascum nigrum*, L., by Rev. G. Henslow, 455.
On *Arnebia* and *Macrotomia*, by C. B. Clarke, 524.
On *Codiolum gregarium*, A. Braun, by E. M. Holmes, 132.
On Indian *Begonias*, by C. B. Clarke, 114.
On Right-hand and Left-hand Contortion, by C. B. Clarke, 468.
On some new Aroidæ; with Observations on other known forms.—Part I., by N. E. Brown, 242.
On the Conifers of Japan, by Maxwell T. Masters, 473.
On the Flora of Kuram Valley, Afghanistan, by J. E. T. Aitchison, 1.
On the Application of the Results of Pringsheim's Recent Researches on Chlorophyll to the Life of the Lichen, by G. Murray, 147.
On the Occurrence of Stipules in *Ilex aquifolium*, by A. Craig Christie, 467.
On the Power possessed by Leaves of placing themselves at Right Angles to the Direction of Incident Light, by F. Darwin, 420.
Onagraceæ (Afghan), 60.
Oncidiæ, 288, 323, 325, 337.
Oncidium, 284, 327; *Papilio*, 281.
Oncodia, 327.
Onobrychis cornuta, 19, 20, 48; *dasycephala*, 7, 48; *microptera*, 7, 48; sp., 49; sp. (near *O. heterophylla*), 49; *spinosissima*, 21, 49.
Ononis arvensis, 17, var. *spinosa*, 42.
Onopordon Acanthium, 16, 71.
Onosma echioides, 81; sp., 81.
Ophelia cordata, 17, 21, 80, var. 80; *Dalhousiana*, 80; *petiolata*, 21.
Ophrydeæ, 349.
Ophrys, 143, 284, 351, 352.
Opuntia Ficus-indica, 145.
Orchidaceæ (Afghan), 99.
Orchideæ, Notes on, by G. Bentham, 281.
—, *conspectus of tribes*, 287; distinctions founded on caudicle and gland doubtful, 285; Lindley's system summarized, 284.

- Orchidofunkia*, 329.
Orchipedium, 344.
Orchis, 143, 284, 351, 353; *globosa*, 351; *hircina*, 351; *latifolia*, 17, 21, 99; *longibracteata*, 351; *longiflora*, 352; *papilionacea*, 352; *pyramidalis*, 351; *rotundifolia*, 351, 355; *spectabilis*, 351.
Oreorchis, 291, 295.
Origanum normale, 86.
Ornitharium, 333.
Ornithidium, 324; *coccineum*, 325; *densum*, 325; *giganteum*, 325; *suave*, 325.
Ornithocephalus, 329.
Ornithochilus, 333, 334, 335.
Orobanche sp., 24, 85.
Orobanchaceæ (Afghan), 85.
Orsidice, 332.
Orthochilus, 316.
Orthonopsis intermedia, 7.
Orthosiphon ambiguus, 394.
Orthosira punctata, 131.
Oryza sativa, 105.
Oscillaria americana, 127; *antillarum*, 127; *princeps*, 127; *tenuis*, var. *calida*, 127.
Oscillariaceæ, 126.
Osyricea, 300.
Othonnopsis intermedia, 70.
Otochilus, 307, 308.
Otostegia limbata, 6.
Ottelia lancifolia, 279.
Oxalis corniculata, 39.
Oxyanthera, 338.
Oxygraphis, 21; sp. nov., 21.
Oxyria reniformis, 20, 21, 91.
Oxysepalum, 299.
Oxystophyllum, 297.

Pachites, 357.
Pachyphyllum, 330, 331.
Pachypterygium sp., 35.
Pachystoma, 302, 304; *Thomsonianum*, 304.
Palmaceæ (Afghan), 99.
Palmellaceæ, 125.
Pangi (Brit. India), notes on, 370.
Panicum Crus-Galli, 106, var., 106; *miliaceum*, 15, 106.
Panisea, 296, 301; *apiculata*, 301; *parviflora*, 301; *reflexa*, 301; *uniflora*, 301.
Panus arenicola, 384; *rivulosus*, 384; *torulosus*, 384.
Papaver dubium, var. *lævigatum*, 32.
Papaveraceæ (Afghan), 32.
Paphinia, 321.
Papperitzia, 329.

Paracaryum anchusoides, 80; *glochidiatum*, 80.
Paradisanthus, 322.
Parietaria debilis, 17, 94; *officinalis*, 17, 94.
Parnassia ovata, 21, 57.
Parrotia Jacquemontiana, 59, 376.
Parvibegonia (subg.), 115.
Passerina hirsuta, 144.
Pattonia, 318.
Paxillus crassus, 383.
Paxtonia, 304, 346, 360.
Pedicularis eximia, 381; *gracilis*, 84; *Hookeriana*, 84; *pectinata*, 84; sp., 12, 20, 84; *tenuirostris*, 84.
Peganum Harmala, 40.
Pelexia, 341, 343.
Pellicularia Koleroga, 461.
Penicillaria spicata, 6.
Peniophora deglubens, 385.
Penium digitus, 129; *oblongum*, 129; *margaritaceum*, 129; *navicula*, 129.
Pennisetum orientale, 107.
Penthea, 358.
Periploca aphylla, 5, 25, 79.
Peristeria, 322; *cerina*, 321; *guttata*, 321.
Peristylus, 354; sp., 13, 100.
Perowskia, 8; *atriplicifolia*, 10, 86.
Pertya Aitchisoni, 12, 72; *scandens*, 72; *ovata*, 72.
Perularia, 354, 356.
Pescatorea, 320.
Pesomeria, 305.
Peucedanum sp., 63.
Péwárkotal, veget. spurs of, 17.
Peziza Thozetii, 388.
Phagnalon acuminatum, 69; *denticulatum*, 69.
Phaius, 284, 285, 296, 304, 305; *albus*, 305; *Bensoniæ*, 305.
Phalænopsis, 332; *Wightii*, 332.
Phallus Watsoni, 387.
Phaseolus vulgaris, 15, 50.
Phelipæa ægyptiaca, 85.
Philadelphus, 376.
Phillips, W., Revision of genus *Vibrissea*, 419.
Phillipsia polyporoides, 388.
Phillyrea angustifolia, 140; *latifolia*, 140.
Phlebia coriacea, 385.
Phlomis bracteosa, 88; *cashmeriana*, 16, 88; *spectabilis*, 17, 88.
Phoenix dactylifera, 144.
Pholidota, 307, 308.
Phormidium australe, 127; *parallelum*, 127; *spadiceum*, 127.
Phreatia, 304.

- Phyllanthus casticum*, 278.
Phyllarthron Bojerianum, 274.
Phyllostachya, 354.
Phymatidium, 329.
Physinga, 314.
Physosiphon, 292.
Physurus, 344; *glandulosus*, 344.
Picea, 476; *ajanensis*, 477, 479, 484, 508, 510, var. *α. genuina* & *β*, 510, var. *microsperma*, 509, var. *japonica*, 509; *alba*, 485; *Alcockiana*, 484, 508; *brachyphylla*, 515; *excelsa*, 485; *firma*, 518; *Glehnii*, 484, 512; *jezoensis*, 509; *Maximowiczii*, 484, 507; *Menziesii*, 477; *nigra*, 485; *obovata*, 484, 506, var. *Schrenkiana*, 484, 506; *orientalis*, 485; *Pichta*, 519; *polita*, 484, 507; *Schrenkiana*, 506; *Smithiana*, 17, 18; *sitkensis*, 477, 479, 485, 510, 511; *tianschanica*, 485, 507; *Tschonoskiana*, 518; *Veitchii*, 515, 518; *Webbiana*, 514.
Picris hieracioides, 73.
Pilumna, 326.
Pimpinella diversifolia, 61; sp.?, 61.
Pinelia, 313.
Pinellia tripartita, 246; *tuberifera*, 246, var. *angustata*, 246.
Pines of Japan, 477.
Pinites, 484, 506.
Pinus, 477; *Abies*, 506; *Alcoquiiana*, 508; *Araragi*, 512; *Banksiana*, 484; *bifida*, 514; *brachyphylla*, 515; *Bungeana*, 484, 506; *Cembra*, 484, 504, 505, var. *β. pumila*, 476, 484, 505; *contorta*, 484; *davurica*, 522; *densiflora*, 478, 484, 503; *excelsa*, 11, 14, 18, 20, 26, 97, 376, 478; *firma*, 514, 515; *Gerardiana*, 18, 20, 26, 27, 98; *halepensis*, 138; *Harryana*, 518; *holophylla*, 514; *homolepis*, 518; *intermedia*, 523; *japonica*, 503; *Kämpferi*, 523; *Khasyia*, 484, 506; *koraiensis*, 476, 484, 504; *lanceolata*, 502; *laricina*, 523; *Larix*, 522; *Ledebourii*, 523; *leptolepis*, 522; *longifolia*, 372; *mandshurica*, 505; *Masoniana*, 484, 504, 505; *microcarpa*, 524; *Menziesii*, 508; *monticola*, 478; *obovata*, 506, var. *β. Schrenkiana*, 506; *orientalis*, 506; *parviflora*, 484, 504; *pendula*, 523; *Picea*, 519; *Pichta*, 519; *Pinaster*, 138, 504; *Pinea*, 138, 503; *polita*, 507; *resinosa*, 478; *rubra*, 504; *selenolepis*, 516; *silvestris*, 484, 505; *sinensis*, 505; *Strobilus*, 478, 504; *Thunbergii*, 484, 504; *Tsuga*, 512; *Veitchii*, 516; *verticillata*, 503; *Webbiana*, 12.
Piptatherum angustifolium, 106; *cæru-*
lescens, 106; *laterale*, 21, 106; sp., 106.
Pistacia cabulica, 5, 10, 42; *integerrima*, 5, 10, 42; *Lentiscus*, 140; sp., 42.
Planifolia, 328.
Plantagineæ (Afghan), 89.
Plantago lanceolata, 89; *major*, 89.
Platanacæ (Afghan), 94.
Platanthera, 355; *rotundifolia*, 355; *satyrioides*, 354.
Platanus orientalis, 94.
Platycentrum (subg.), 118.
Platycladus dolabrata, 486.
Platyclinis, 295.
Platycoryne, 358.
Platylepis, 346; *heteromorpha*, 346.
Platysma, 338.
Platystylis, 295.
Plectranthus rugosus, 10, 85.
Plectrophora, 326.
Pleione, 308.
Pleuranthium, 312, 313.
Pleurospermum corydalifolium, 21, 62; *pulchrum*, 63.
Pleurostachys, 361, 362.
Pleurothallæ, 287, 291.
Pleurothallis, 292; *purpurea*, 292; *tubulosa*, 292.
Plexaure, 304.
Plocoglottis, 319.
Plocostigma, 338.
Plumbagineæ (Afghan), 76.
Poa bulbosa, 21, 108, var. *vivipara*, 108; *flexuosa*, 21, 108; *laxa*, 21, 108; sp., 108; *trivialis*, 108.
Podanthera, 349.
Podocarpus, 475, 476, 479, 501; *appressa*, 484, 501; *cæsia*, 484, 501; *chinensis*, 484, 502; *cuspidata*, 484, 502; *grandifolia*, 484, 502; *japonica*, 484, 502; *koraiana*, 484; *macrophylla*, 484, 501; *Maki*, 501; *Nageia*, 484, 501, vars. *rotundifolia*, 501, & *angustifolia*, 501.
Podochilus, 338, 340.
Podophyllum Emodi, 32.
Pogonia, 304, 348.
Polychilus, 332.
Polycycnis, 322.
Polygala abyssinica, 36; *Hohenackeriana*, 36; *sibirica*, 36; *volubilis*, 265.
Polygalææ (Afghan), 36.
Polygonacææ (Afghan), 90.
Polygonatum multiflorum, 10, 103; *verticillatum*, 10, 24, 103; var. *gracile*, 103.
Polygoniaceæ (Afghan), 90.
Polygonum amplexicaule, 90; *aviculare*, 90, var. 90; *Bellardi*, var. *β. patulum*, 90; *biaristatum*, 20, 90; *Con-*

- volvulus, 90; dumetorum, 90; glabrum, 90; nepalense, 90; paronychioides, 90; perforatum, 90; runcifolium, 13, 90; sp. 91.
- Polypodium clathratum**, 12, 112; *Dryopteris*, 112.
- Polypogon littoralis**, 107; sp., 107; *monspeliensis*, 107.
- Polyporus ferreus**, 385; *picipes*, 385; *scabrusculus*, 384; *sulfureus*, 385; *vaporarius*, 385.
- Polysaccum pisocarpium**, 386; *tuberosum*, 386.
- Polystachya**, 317, 319.
- Pomatocalyx**, 335.
- Ponera**, 312, 313; *adendrobium*, 313.
- Ponerorchis**, 355.
- Ponthieva**, 341, 343.
- Populus alba**, 9, 14, 96, var. *denudata*, 9, 96; *nigra*, 14, var. *afghanica*, 15, 27, 96.
- Porpax**, 302.
- Porphyrostachys**, 342.
- Portulaca oleracea**, 38.
- Portulacæ (Afghan)**, 38.
- Position of Leaves with regard to Light**, 420.
- , Conclusions thereon, 447; Darwin's researches, 424; Definition of terms, 426; De Vries's theory, 421; diaheliotropic plane, 429.
- , experiments testing, 429; with Beans, 437; Cherries, 439; *Klinostat*, 441; *Plantain*, 438; *Ranunculus Ficaria*, 429; *Vegetable Marrow*, 438.
- , Frank's theory, 421; fundamental exp., 425; lateral position, 428; light parallel to axis, 426; Sachs's views thereon, 422; transverse plane, 428; zenith position, 427.
- Potamogeton oblongus**, 99.
- Potentilla**, 374; *argyrophylla*, 53; *Colletiana*, 13, 53; *fragarioides*, var. *pumila*, 53, var. *Gerardiana*, 53; *monanthes*, 22, 53; *multifida*, 53; *reptans*, 53; *sericea*, 22, 53; *Sibbaldi*, 52; *supina*, 53.
- Poterium sanguisorba**, 54.
- Prangos pabularia**, 19, 62.
- Prenanthes sp.**, 73.
- Preptanthe**, 308.
- Prescottia**, 341, 342.
- Primula denticulata**, 17, 21, 77, 375, var. 13; *floribunda*, 373; *purpurea*, 21, 22, 77, 375; *rosea*, 12, 77, 375.
- Primulacæ (Afghan)**, 77.
- Pringsheim's recent Researches on Chlorophyll**, application of the results of, to the life of the Lichen, 147.
- Promenæa**, 320; *graminea*, 321.
- Prosthechea**, 314.
- Protococcaceæ**, 125.
- Protococcus viridis**, 125.
- Provence, vegetation littoral districts of**, 135.
- Prunus Amygdalus**, 50; *armeniaca*, 51, 374; *Cerasus*, 51; *communis*, var., 51; *eburnea*, 50; *Jacquemontii*, 11, 17, 51; *Padus*, 11, 24, 51, 374; *persica*, 51; sp. ? (near *P. Amygdalus*), 50.
- Pseudepidendrum**, 314.
- Pseuderiopsis**, 321.
- Pseudocentrum**, 341, 342.
- Pseudotsuga Douglasii**, 485.
- Psilanthemum**, 314.
- Psilocarya**, 365.
- Psilonia nivea**, 388.
- Psittacoglossum**, 324.
- Psychechilus**, 345.
- Pterichis**, 341.
- Pterocephalus speciosus**, 16.
- Pteroceras**, 333.
- Pteroglossaspis**, 319, 320.
- Pteroscleria**, 366.
- Pterygodium**, 358.
- Ptichochilus**, 341.
- Punica**, 6, 10; *granatum*, 59.
- Pycreus**, 361.
- Pyrus Aucuparia**, 12, 56; *communis*, 55; *lanata*, 12, 24, 55; *Malus*, 55; sp., 55; *variolosa*, 6.
- Quekettia**, 329.
- Quercus coccifera**, 139; *Ilex*, 10, 11, 14, 15, 19, 25, 27, 95, 138; *Robur*, 139; *semecarpifolia*, 11, 15, 27, 95; *Suber*, 138.
- Queteletia**, 344.
- Ranunculacæ (Afghan)**, 29.
- Ranunculus**, 374; *aquatilis*, 373; *arvensis*, 30; *Baurii*, 390; *diffusus*, var. *hydrocotyloides*, 377; *divergens*, 30; *falcatus*, var. *orthoceras*, 30; *hirtellus*, 30, 377, and var., 30; *lætus*, 30, and var., 30, 372; *muricatus*, 372; *pangiensis*, 377; *pinnatus*, 264; *scleratus*, 372, var. *mysuroides*, 377; sp. ?, 30.
- Raphanus Raphanistrum**, 35.
- Raphidium polymorphum**, 125.
- Remarks on the Indian Coffee-Leaf Disease**, by W. Bidie, 458.
- Remirea**, 365.
- Renanthera**, 331, 334; *bilinguis*, 332; *coccinea*, 334; *elongata*, 334; *matutina*, 334; *micrantha*, 334; *Sulingi*, 332.

- Reptonia buxifolia*, 5.
Reseda luteola, 35.
 Resedaceæ (Afghan), 35.
 Resin-canals of Conifers, 510.
Restrepia, 292, 313.
Retinospora, 476; *andelyensis*, (ftnote) 496; *argentea*, (ftnote) 495; *decurvata*, 495; *decussata*, 495; *Devriesiana*, 425; *dubia*, 425, (ftnote) 495; *Ellwangeriana*, (ftnote) 495; *filioides*, 494; *glauca*, (ftnote) 495; *japonica*, 495; *juniperoides*, (ftnote) 495; *leptoclada*, 491, (ftnote) 495, 496; *lycopodioides*, 493; *meldensis*, (ftnote) 495; *obtusa*, 492, vars. *pygmaea*, 493, *nana*, 493; *plumosa*, 490; *pseudo-squarrosa*, (ftnote) 495, 496; *recurvata*, (ftnote) 495; *rigida*, (ftnote) 495; *squarrosa*, 490, 495, (ftnote) 495, 496, var. *leptoclada*, (ftnote) 495, 496; *tetragona*, 495.
 Revision of the Genus *Vibrissa*, by W. Phillips, 419.
Rhamnæ (Afghan), 40.
Rhamnus Alaternus, 140; *dahuricus*, 10, 11, 25, 41; *persicus*, 10, 40; *purpureus*, 10, 11, 41, 374; sp., 41.
Rhamphidia, 346; *alsinæfolia*, 345; *grandiflora*, 345.
Rheum Moorcroftianum, 13, 19, 21, 91; *Ribes*, 19, 91.
Rhizoclonium antillarum, 124; *spongiosum*, 124.
Rhodocodon madagascariensis, 280.
Rhododendron afghanicum, 12, 26, 75; *campanulatum*, 375, 376; *Colletianum*, 21, 25, 75; sp. (near *campanulatum*), 12.
Rhomboda, 346.
Rhus Cotinus, 10, 40.
Rhynchadenia, 338.
Rhynchanthera, 341.
Rhynchospora, 362, 365; *sparsa*, 361.
Rhynchosporæ, 365.
Rhynchosstele, 328.
Rhynchostyles, 332, 334.
Ribes, 376; *Grossularia*, 13, 17, 57; *orientale*, 17, 25, 57; *rubrum*, 13, 57.
Ricinus communis, 5, 93.
Riviera, flora of Ligurian, 135.
Robiquetia, 334.
Rochelia stellulata, 80.
Rodriguezia, 326, 329; *secunda*, 326.
Rœmeria hybrida, 32; *rhæadiflora*, 32.
Rophostemon, 348.
Rosa anserinæfolia, 15, 54, var. *cabulica*, 54; *canina*, 15, var., 54; *damascena*, 9, 54; *Ecæ*, 14, 16, 18, 54; *Eglantheria*, 15, 54; *macrophylla*, 54, 376; *moschata*, 10, 54, 372, 374; *Webbiana*, 9, 10, 54, 376.
 Rosaceæ (Afghan), 50.
Rosmarinus officinalis, 140.
Rubia cordifolia, 65; *Kotschyi*, 65.
 Rubiaceæ (Afghan), 65.
Rubus fruticosus, observations on, 406, var. 52; *lasiocarpus*, 52; *leucanthus*, 52; *niveus*, var. *Aitchisoni*, 52; *purpureus*, 52; *rosæfolius*, 268; sp.?, 374.
Rumex nepalensis, 91; *orientalis*, 91; sp., 91.
Russula sanguinea, 383.
Ruta acutifolia, 18, 40.
 Rutaceæ (Afghan), 40.
Saccharum spontaneum, 111; sp., 111.
 Saccidium, 353.
Saccochilus, 334.
Saccolabium, 332, 333, 335; *acuminatum*, 334; *brevifolium*, 334; *densiflorum*, 334; *filiforme*, 334; *giganteum*, 334; *Hilli*, 334, 335; *lineolatum*, 334; *peninsulare*, 334; *reflexum*, 334; *roseum*, 334.
 Safed Koh, vegetation flanks of, 8; valleys of, 10; elevations of, 8000-11,000 feet, 12.
Sageretia, 6; *Brandrethiana*, 4; sp., 41.
Sagittaria sagittifolia, 99.
 Salacinæ (Afghan), 95.
Salacistis, 346.
Salisburia adiantifolia, 500.
Salix amophylla, 5, 95; *angustifolia*, 15, 95; *daphnoides*, 96; *elegans*, 12, 95; *grisea*, 12, 96; *pyncostachys*, 96; sp., 96; sp. near *babylonica*, 5; sp. near *seriocarpa*, 15; *viminalis*, 27.
Salvadora oleoides, 15.
Salvia cryptoclada, 275; *glutinosa*, 8; 86; *leucodermis*, 276; *Moorcroftiana*, 86; *plebeia*, 86; *porphyrocalyx*, 277; *rhytidea*, 8, 86; *sessilifolia*, 276.
 Santalaceæ (Afghan), 92.
 Sapindaceæ (Afghan), 41.
Saponaria Griffithii, 37; *Vaccaria*, 37.
 Sarcantheæ, 288, 329, 334, 335.
Sarcochilus, 332, 333; *teres*, 333; *usneoides*, 333.
Sarcoglottis, 343.
Sarcopodium, 297, 298.
Sarcocyuca, 220.
Satyridium, 357.
Satyrium, 357; *pumilum*, 357.
Saundersia, 327.
Sauroglossum, 343; *elatum*, 343.
Sauromatum pulchrum, 255; *punctatum*, 256; *sessiliflorum*, 256; *simlense*, 256; *venosum*, 257.
Saussurea hypoleuca, 71.

- Saxifraga*, 11; *afghanica*, 56; *ligulata*, 56.
Saxifragaceæ (Afghan), 56.
Scabiosa afghanica, 67; *Olivierii*, 7, 16, 67; sp., 67.
Scandix Pecten-veneris, 61.
Scaphyglottis, 310, 311, 313; *parviflora*, 325; *pendula*, 325.
Scelochilus, 326.
Schismoceras, 297.
Schizochilus, 358.
Schizodium, 358.
Schizophyllum multifidum, 384.
Schizostauron crucicula, 131.
Schizothrix Cresswellii, 132.
Schlimmia, 323.
Schænopsis, 361.
Schœnorchis, 335; *juncifolia*, 334.
Schœnoxiphia, 367.
Schœnoxiphium, 366; *Dregeanum*, 367; *rufum*, 367.
Schœnus, 365; *compar*, 362; *compressus*, 362; *nigricans*, 104.
Schomburgkia, 312, 315.
Schubertia japonica, 498.
Sciadopitys verticillata, 481, 484, 502, 593, var. *variegata*, 503.
Scirpeæ, 365.
Scirpus, 364, 365; *dipsaceus*, 362; *grossus*, 363; *lacustris*, 363; *maritimus*, 104; *Michelianus*, 362; *setaceus*, 104; *tabernamontanus*, 363.
Scleria, 364, 366; *capitata*, 366.
Scleriæ, 367.
Scleropteris, 338.
Scopularia, 353.
Scorzonera mollis, 7, 74.
Scrophularia cabulica, 83; sp., 21, 83.
Scrophularinæ (Afghan), 83.
Scutellaria linearis, 87; sp., 16, 87.
Scuticaria, 323; *Steeii*, 324.
Scytonema ærugineo-cinereum, 125.
Scytonemacææ, 125.
Secale acemphylla, 9; *cereale*, 9, 23, 110.
Sedum adenotrichum, 59; *asiaticum*, 58; *Ewersii*, 21, 58; *pachyclados*, 58; *rosulatum*, 58.
Selaginæ (Afghan), 85.
Selaginella sanguinolenta, 11, 113.
Selenipedium, 359; *caudatum*, 360; *palmifolium*, 359.
Selinum papyraceum, 62.
Sempervivum acuminatum, 21, 59.
Senecio chrysanthemoides, 70; *coronopifolius*, 70; *microdontus*, 271; *pallens*, var. *violacea*, 70; *sisymbriiformis*, 70; *trullæfolius*, 392.
Septoria, 462; *maculosa*, 462.
Sequoia, 476, 481; *gigantea*, 483; *sempervirens*, 483.
Seraphyllum, 291.
Serapiadææ, 288, 351.
Serapias, 143, 284, 351; *cordigera*, 352; *longipetala*, 352; *triloba*, 352.
Setaria glauca, 106; *italica*, 15, 106; *viridis*, 106.
Sertifera, 339, 340.
Seseli sibiricum, 17, 61.
Siagonathus, 325.
Siegesbeckia orientalis, 69.
Sieveckingia, 322.
Sigmatostalix, 327, 328; *pictum*, 328; *radicans*, 328.
Sikarâm, veget. of, 17, 20.
Silene conoidea, 37; *inflata*, 37; *Moorcroftiana*, 37; sp., 37.
Silver Firs of Japan, 476.
Simethus bicolor, 142.
Sisymbrium Alliaria, 34; *columnæ*, 34; *himalaicum*, 34; *Lœselii*, 34; *Sophia*, 34; *strictum*, 34; *Thomsoni*, 378; *Wallichii*, 34.
Skimmia Laureola, 374.
Smilacææ (Afghan), 101.
Smilax aspera, 140; *vaginalis*, 10, 101.
Sobralia, 299, 339, 340.
Sodaroa, 337.
Solanacææ (Afghan), 82.
Solanum Dulcamara, 16, 26, 82; *Melongena*, 82; *nigrum*, 82; *tuberosum*, 82.
Solenidium, 327, 328.
Solidago Virga-aurea, 67.
Sonchus arvensis, 74; *asper*, 74.
Sophora, 6, 8, 10, 14, 15, 16, 18; *alopencuroides*, 16, 50; *mollis*, 6, 23, 50, 380.
Sophrontis, 312, 313, 315.
Sopubia madagascariensis, 273.
Sorghum vulgare, 6.
Spartium, 140.
Spathoglottis, 304.
Specklinia graminea, 328.
Spermodon, 361.
Sphærella, 462; *coffeicola*, 464; *isariophora*, 466; *Taxi*, 464.
Sphæria Schomburgkii, 389.
Sphærostilbe dubia, 389.
Sphærozyga oscillarioides, 126.
Spiræa, 374; *brahuica*, 52; *sorbifolia*, 52; *vestita*, 52.
Spirantheæ, 288, 337, 339, 341.
Spiranthes, 143, 341, 342; *adnata*, 344; *bonariensis*, 343; *elata*, 343; *hirta*, 343; *Hostmanni*, 345.
Spirogyra dubia, var. *longiarticulata*, 125; *longata*, 125; *tropica*, 125.
Spondylium pulchellum, 128.
Spruce Firs of Japan, 476.
Stachyobium, 297.

- Stachys floccosa*, 88; *parviflora*, 7, 88; sp., 19, 88.
Standishii, 476.
Stanhopea, 322.
Stanhopeiæ, 288, 318, 322, 323.
Staphylea Emodi, 11, 41.
Staurostrum aristiferum, 129; *gracile*, 129; *inequale*, 129; *quadrangulare*, var. β . *attenuatum*, 129.
Stauroglossum, 345.
Stauroglottis, 332.
Stauroneis anceps, 131, 132, var. *linearis*, 130; *birostris*, 131; *linearis*, 132; *phœnicenteron*, 130; *phyllodes*, 130.
Stauropsis, 331, 334.
telis, 292.
Stellaria bulbosa, 38; *crispa*, 37; *media*, 37; sp. ?, 38; *Webbiana*, 37.
Stemonitis ferruginea, 387.
Stenia, 322, 323.
Stenocoryne, 321.
Stenoglossæ, 287, 309.
Stenoglossum, 310.
Stenoglottis, 352, 353, 355.
Stenoptera, 341, 342.
Stenorhynchus, 343.
Stenoselenium perenne, 525.
Stereochilus, 333.
Stereosandra, 347.
Stereum caperatum, 385; *lobatum*, var. *resupinatum*, 385; *spongiaepes*, 385; *Thozetii*, 385.
Stigeoclonium plumosum, 123.
Stilbum flavidum, 465.
Stipa pennata, 107; *sibirica*, 10, 26, 107.
Stipules in Illicinæ, 467.
Strobilanthes alata, 85.
Strongylodon madagascariensis, 267.
Strychnos spinosa, 273.
Styloglossum, 308.
Styrax officinale, 141.
Sunipia, 294.
Surirella arcta, 132; *biseriata*, 130; *demerare*, 132; *linearis*, 130, 131, 133; *oophæna*, 130; *panduriformis*, 130; *tenera*, 130.
Sutrina, 327.
Swertia petiolata, 17, 79.
Synassa, 343.
Synedra biceps, 130, 132; *capitata*, 131; *obtusata*, 132; *pulchella*, 130; *radians*, 131; *ulna*, 130, 132; *vitrea*, 132.
Synmeria, 355.
Synopsis of Aloinæ and Yuccoidæ, by J. G. Baker, 148.
Syringa Emodi, 11, 78; *persica*, 10, 78.
Tachadenus carinatus, 273.
Tæniophyllum, 335.
Tamariscinæ of Afghanistan, 38.
Tamarix sp. ?, 38.
Tanacetum millefoliatum, 69; sp., 19, 21, 69.
Taraxacum Dens-leonis, 73; *montanum*, 73; *parvulum*, 73.
Taxites, 484.
Taxodium, 478, 498; *distichum*, 478, 483, var. β . *microphyllum*, 498; *heterophyllum*, 498; *japonicum*, 497; *sinense pendulum*, 498.
Taxus, 484, 499; *adpressa*, 500; *baccata*, 11, 13, 97, 484, 500, var. *microcarpa*, 500; *brevifolia*, 478; *canadensis*, 478; *cuspidata*, 478, 484, 499; *distichum*, 478, 483, var. β . *microphyllum*, 498; *Harringtonia*, 499; *heterophyllum*, 478, 483, 498; *Inukaja*, 499; *macrophylla*, 502; *nucifera*, 500; *tardiva*, 484, 500; *verticillata*, 503.
Tecoma undulata, 4.
Telipogon, 338; *astroglossus*, 338.
Teretifolia, 328.
Tertiary Flora of Europe and America compared, 478.
Tetmemorus granulatus, 129.
Tetragamestum, 312; *modestum*, 313.
Tetramicra, 311, 312, 314; *montana*, 314; *platyphylla*, 314; *rigida*, 314.
Tetrapeltis, 308.
Tetralia, 361.
Teucrium Royleanum, 89.
Thalictrum minus, 30, vars. *flexuosum*, 30, *glandulosum*, 30.
Thecaphora Leptocarpi, 388.
The Coffee-Disease in South America, by M. C. Cooke, 461.
 — in India, by W. Bidie, 458.
Thecostele, 318.
Thelasis, 338.
Thelephora caryophylla, 385.
Thelymitra, 346, 347.
Theory of the Growth of Cuttings; illustrated by Observations on the Bramble, *Rubus fruticosus*, by F. Darwin, 406.
Therophonum crenatum, 259; *infaustum*, 260; *Wightii*, 259; *zeylanicum*, 258.
Thesium divaricatum, 92.
Thisbe, 352.
Thlaspi alpestre, 34; *arvense*, 34; *cardiocrinum*, 34.
Thorea Trailii, 123.
Thozetia nivea, 388.
Thrixspermum, 332, 333.
Thunia, 305.
Thuyopsis dolabrata, 486; *Standishii*, 487.

- Thuja*, 486; *Devriessiana*, (fnote) 495; *dolabrata*, 483, 486, vars. *nana*, 486, *variegata*, 486, *læte-virens*, 486; *Ellwangeriana*, (fnote) 495; *ericoides*, (fnote) 495; *excelsa*, 483; *filiformis*, 488; *gigantea*, 477, 478, 479, 487, 483, var. *japonica*, 487; *hybrida*, (fnote) 495; *japonica*, 476, 477, 478, 479, 483, 486, (fnote) 495; *leptoclada*, (fnote) 496; *lineata*, 498; *meldensis*, (fnote) 495; *obtusata*, 483, 491, form of, 495, vars. *lycopodioides*, 493, *pygmaea*, 493, *nana*, 493, *Keteleerii*, 493, *breviramea*, 494, *pendula*, 494, *flicoides*, 494; *occidentalis*, 478, 483, form of, 495; *orientalis*, 477, 483, 488, var. *meldensis*, (fnote) 495, var. β . *pendula*, 488; *pendula*, 488; *pensilis*, 498; *pisifera*, 483, 489, vars. *squarrosa*, 490, *leptoclada*, 490, *plumosa*, 490, *filifera*, 491, 492; *squarrosa*, (fnote) 496; *Standishii*, 486.
- Thuyites*, 493, 495.
- Thuyopsis*, 476, 486, 487.
- Thymelacæ* (Afghan), 91.
- Thymelæa arvensis*, 92.
- Thymus Serpyllum*, 7, 80; *vulgaris*, 140.
- Tilmadoche mutabilis*, 387.
- Tinea*, 354, 355.
- Tipularia*, 291, 295.
- Torreya*, 475, 476, 500; *californica*, 484, 478; *grandis*, 478, 484, 499, 500; *nucifera*, 478, 484, 500; *taxifolia*, 478, 484.
- Townsend, F., on an *Erythræa* new to England, from the Isle of Wight and the South Coast, 398.
- Tragopogon junceum*, 74.
- Trasi*, 361.
- Traunsteineria*, 351.
- Trias*, 300.
- Trichelostylis*, 361.
- Trichocentrum*, 326.
- Trichoceros*, 338.
- Trichochilia*, 357.
- Trichodesma*, 16; sp., 80.
- Trichoglottis*, 333; *lanceolata*, 333; *pallens*, 333; *philippinensis*, 333; *pusilla*, 333; *quadricornutus*, 333; *retusa*, 333; *rigida*, 333.
- Trichopilium*, 326.
- Trichosma*, 303, 307.
- Trichotosia*, 303.
- Trifolium fragiferum*, 42; *pratense*, 42; *repans*, 42; *resupinatum*, 9, 15, 24, 25, 42.
- Triglochin palustre*, 17, 99.
- Trigonella corniculata*, 42; *Emodi*, 42; *polycerata*, 42; *pubescens*, 42.
- Trigonidium*, 323, 327, 329.
- Trilepis*, 366, 367.
- Triphora*, 348.
- Tripleura*, 345.
- Trizeuxis*, 327, 329.
- Trophianthus*, 326.
- Tropidia*, 340, 341.
- Tryphia*, 353.
- Tsuga*, 475, 512; *canadensis*, 478, 485; *diversifolia*, 478, 485, 514; *dumosa*, 485; *Mertensiana*, 478, 485; *Pattonianiana*, 485; *Sieboldi*, 478, 485, 512, var. β . *nana*, 512.
- Tubera*, 333.
- Tubulina nitidissima*, 387.
- Tulipa chrysantha*, 7, 16, 103; *Clusiana*, 143; *præcox*, 143; *stellata*, 7, 16, 103, var., 103.
- Tulostoma mammosum*, 386.
- Tussilago Farfara*, 17, 70.
- Typhonium cuspidatum*, 262; *divaricatum*, 262; *fallax*, 260; *Huegelianum*, 261; *pedatum*, 260; *trilobatum*, 261.
- Uapaca clusiacea*, 278.
- Ulantha*, 349.
- Ulex europæus*, 141.
- Ulmus campestris*, 12, 93; sp., 93.
- Ulothricacæ*, 124.
- Ulothrix oscillaria*, 124.
- Umbelliferæ* (Afghan), 60.
- Uncifera*, 334.
- Uncinia*, 367.
- Urera Radula*, 279.
- Urginea alooides*, 395.
- Uropedium*, 346, 360.
- Urostachya*, 303.
- Urtica dioica*, 94, var., 94.
- Urticacæ* (Afghan), 93.
- Valeriana dioica*, 20, 66; *petrophila*, 21, 66; sp., 66; *Wallichiana*, 25, 66.
- Valerianæ* (Afghan), 66.
- Valerianella* sp. ♀, 66.
- Vanda*, 331; *Cathcartii*, 332; *densiflora*, 334; *Loweii*, 331; *parviflora*, 333; *violacea*, 332.
- Vandæ*, 284, 286, 287, 291, 296, 315, 338.
- Vanilla*, 339.
- Vanilleæ*, 288, 338, 339.
- Vaucheria* sp. ♀, 126.
- Vaucheriaceæ*, 125.
- Verbascum eriantha*, 8; *erianthemum*, 83; *nigrum*, *proliferous* condition of, 455; *Thapsus*, 8, 83.
- Verbena officinalis*, 85.
- Verbenacæ* (Afghan), 85.

- Vernonia tanalensis*, 271.
Veronica agrestis, var., 83, 84; *anagallis*, 84; *bartsiaefolia*, 84; *Beccabunga*, 84; *biloba*, 84, var., 84; *campylopoda*, 84.
Vibrissea, a Revision of the Genus, by W. Phillips, 419.
 ——— *Guernesaci*, 419; *Persooni*, 419; *pubescens*, 419; *rimarum*, 419; *truncorum*, 419.
Viburnum cotinifolium, 10, 64, 374.
Vicia sativa, 49.
Vignea, 361.
Vinca lancea, 273; *media*, 142.
Vincetoxicum sp., 79.
Viola arenaria, 380; *biflora*, 35, 378; *canescens*, 379; *canina*, var. *sylvatica*, 380; *kunawarensis*, 380; *Patrinii*, 35, 379, var. *suaveolens*, 379; *serpens*, 35, 379; sp. P., 35, 36.
 Violaceæ (Afghan), 35.
Viscum, 14; *album*, 92; *articulatum*, 92.
Vitis microdiptera, 266; *vinifera*, 41.
Voltzia, 483.
Vrydagzenia, 344.
- Wailesia*, 318.
Warrea, 321; *cinerea*, 321.
Warszewiczella, 320.
 Watt, G., Notes on the Vegetation &c. of Chumba State and British Lahoul; with Descriptions of new Species, 368.
Widdringtonia ericoides, (ftnote) 496.
Wikstrœmia virgata, 92.
Withania, 6; *coagulans*, 4, 82.
Woodfordia floribunda, 270.
Woodsia hyperborea, 111.
Wulfenia Amherstiana, 12, 83.
Wullschlægelia, 341; *calcarata*, 342.
- Xanthidium regulare*, 129.
Xanthium Strumarium, 69.
Xiphion Stocksii, 6, 100.
Xiphosium, 303.
Xylaria Hypoxylon, 389.
Xylobium, 324, 321.
- Yoania*, 349.
Yucca acaulis, 231; *aloifolia*, 220, 221; *arcuata*, 221; *Atkinsi*, 221; *angustifolia*, 226, var. *stricta*, 227; *baccata*, 220, 229, vars. *australis*, 229, *circinata*, 230, *fragilifolia*, 230, *hystrix*, 230, *periculosa*, 229, *scabrifolia*, 230; *Boerhaavii*, 220, 224; *brevifolia*, 220, 221; *canaliculata*, 226; *conspicua*, 221; *constricta*, 220, 229; *crenulata*, 221; *Desmetiana*, 220, 222; *Draconis*, 221; *exigua*, 220, 223; *filamentosa*, 220, 227, vars. *antwerpensis*, 228, *bracteata*, 228, *concava*, 228, *flaccida*, 228, *glaucescens*, 228, *lævigata*, 228, *maxima*, 227, *orchioides*, 228, *puberula*, 228; *flexilis*, 220, 224, vars. *ensifolia*, 224, *falcata*, 224, *gigantea*, 224, *nobilis*, 224, *semicylindrica*, 224; *funifera*, 220, 228; *glaucæ*, 220, 223; *gloriosa*, 220, 225, vars. *acuminata*, 226, *Ellacombei*, 226, *minor*, 225, *obliqua*, 225, *plicata*, 225, *pruinosa*, 226, *recurvifolia*, 225, *rufocincta*, 225, *superba*, 225, *tortulata*, 226; *graminifolia*, 230; *guatemalensis*, 220, 222; *Mooreana*, 222; *patens*, 226; *Peacockii*, 220, 223; *purpurea*, 221; *quadricolor*, 221; *rupicola*, 220, 222, var. *rigida*, 223; *Schottii*, 220, 228; *serrulata*, 221; *spinosa*, 230; *tenuifolia*, 221; *Treculeana*, 220, 226; *tricolor*, 221; *Whipplei*, 221, 230; *yucatanæ*, 220, 221.
Yuccas, gen. remarks on, 151.
 Yuccoideæ and Aloineæ, synopsis of, 148.
 ——— (defined), 152.
- Zanthoxylum alatum*, 374.
Zea Mays, 105.
Zeuxine, 345.
Ziziphora clinopodioides, 86; *tenuior*, 86.
Zizyphus Jujuba, 5; *oxyphylla*, 5; *vulgaris*, 40, 374, f. *nummularia*, 4, 6, 9.
Zosterospermum, 361.
Zygnema subtile, 125.
 Zygnemaceæ, 125.
Zygodesmus, 461.
Zygglossum, 299.
Zygonium ericetorum, 125; *peruvianum*, 125.
Zygotepalum, 316, 319, 320, 321; *tricolor*, 321.
Zygosepalum, 320.
Zygostates, 329.

END OF THE EIGHTEENTH VOLUME.



48214A

UNIVERSITY OF CALIFORNIA
LOS ANGELES
LIBRARY

40214A

UNIVERSITY OF CALIFORNIA

VI

LOS ANGELES

LIBRARY

Digitized by Google



UNIVERSITY OF CALIFORNIA LIBRARY

Los Angeles

This book is DUE on the last date stamped below.

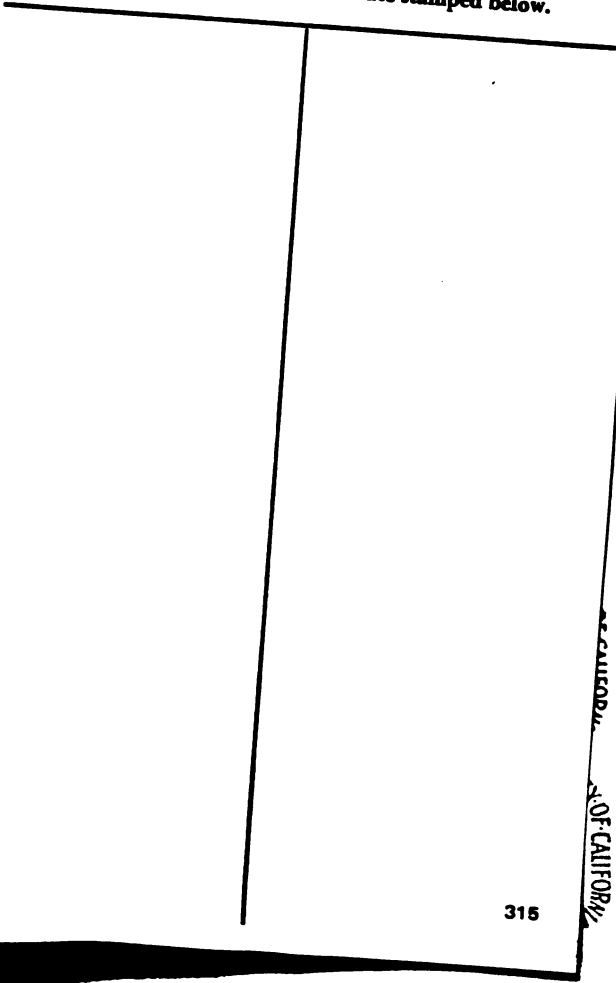

315

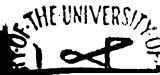

Handwritten text from the reverse side of the page, appearing as bleed-through. The text is partially obscured by a dark vertical bar on the right edge of the image.

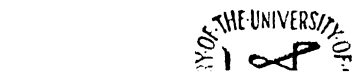

UNIVERSITY OF CALIFORNIA LIBRARY

Los Angeles

This book is DUE on the last date stamped below.

Large empty rectangular area for stamping due dates.

315

University of California, Los Angeles



L 007 193 755 1

THE LIBRARY OF THE UNIVERSITY OF CALIFORNIA - LOS ANGELES

THE LIBRARY OF THE UNIVERSITY OF CALIFORNIA - LOS ANGELES

THE LIBRARY OF THE UNIVERSITY OF CALIFORNIA - LOS ANGELES

THE LIBRARY OF THE UNIVERSITY OF CALIFORNIA - LOS ANGELES

THE LIBRARY OF THE UNIVERSITY OF CALIFORNIA - LOS ANGELES

THE LIBRARY OF THE UNIVERSITY OF CALIFORNIA - LOS ANGELES

THE LIBRARY OF THE UNIVERSITY OF CALIFORNIA - LOS ANGELES

THE LIBRARY OF THE UNIVERSITY OF CALIFORNIA - LOS ANGELES

THE LIBRARY OF THE UNIVERSITY OF CALIFORNIA - LOS ANGELES

THE LIBRARY OF THE UNIVERSITY OF CALIFORNIA - LOS ANGELES

THE LIBRARY OF THE UNIVERSITY OF CALIFORNIA - LOS ANGELES

THE LIBRARY OF THE UNIVERSITY OF CALIFORNIA - LOS ANGELES

THE LIBRARY OF THE UNIVERSITY OF CALIFORNIA - LOS ANGELES

THE LIBRARY OF THE UNIVERSITY OF CALIFORNIA - LOS ANGELES

THE LIBRARY OF THE UNIVERSITY OF CALIFORNIA - LOS ANGELES

THE LIBRARY OF THE UNIVERSITY OF CALIFORNIA - LOS ANGELES

THE LIBRARY OF THE UNIVERSITY OF CALIFORNIA - LOS ANGELES

THE LIBRARY OF THE UNIVERSITY OF CALIFORNIA - LOS ANGELES

THE LIBRARY OF THE UNIVERSITY OF CALIFORNIA - LOS ANGELES

THE LIBRARY OF THE UNIVERSITY OF CALIFORNIA - LOS ANGELES

THE LIBRARY OF THE UNIVERSITY OF CALIFORNIA - LOS ANGELES

THE LIBRARY OF THE UNIVERSITY OF CALIFORNIA - LOS ANGELES

THE LIBRARY OF THE UNIVERSITY OF CALIFORNIA - LOS ANGELES

THE LIBRARY OF THE UNIVERSITY OF CALIFORNIA - LOS ANGELES

THE LIBRARY OF THE UNIVERSITY OF CALIFORNIA - LOS ANGELES

THE LIBRARY OF THE UNIVERSITY OF CALIFORNIA - LOS ANGELES

THE LIBRARY OF THE UNIVERSITY OF CALIFORNIA - LOS ANGELES

THE LIBRARY OF THE UNIVERSITY OF CALIFORNIA - LOS ANGELES

THE LIBRARY OF THE UNIVERSITY OF CALIFORNIA - LOS ANGELES

THE LIBRARY OF THE UNIVERSITY OF CALIFORNIA - LOS ANGELES



