

SINGLE LEVER COMPONENTS

STOP FOR DANZE/GERBER/PEGASUS



CC19056-3

TEMPURATURE RING FOR S/L CARTRIDGES



CC-RING

TEMPURATURE RING FOR T & S CARTRIDGES



PBCV-RING

CHECK VALVE FOR DELTA



OEM # RP73625

CC19054-CV

MIXER FOR PRESSURE BALANCE VALVES



CC-MIX

SINGLE LEVER MIXER FOR PRESSURE BALANCE VALVES



PBCV-MIX

SINGLE LEVER COMPONENTS

PRESSURE BALANCE
CARTRIDGE FOR KOHLER

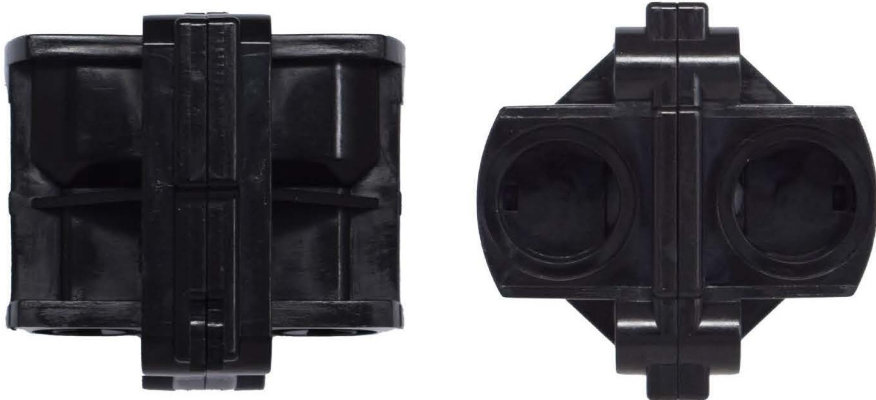

OEM # GP500520
KO11182

PRESSURE BALANCE
MIXER FOR PRICE PFISTER



OEM # C974-291
PP11695

PRESSURE BALANCE
MIXER FOR PEGASUS



PE-BALMIX

SINGLE LEVER COMPONENTS

FOR AMERICAN STANDARD
LENGTH: 57mm / 2.26"



OEM # 077171-0070A

AS10183

FOR AMERICAN STANDARD
LENGTH: 61mm / 2.415"



OEM # 51091-0070A

AS10181

FOR AMERICAN STANDARD
LENGTH: 65mm / 2.54"



OEM # M952100-0070A

AS10182

FOR GERBER
LENGTH: 90mm / 3.56"



OEM # 97-013

GE10780

FOR GERBER
LENGTH: 90mm / 3.56"



OEM # 97-014

GE10781

SINGLE LEVER CARTRIDGES

FOR SIGMA
LENGTH: 42mm / 1.635"



DIAMETER: 22mm
OEM #18.30.219

CC19100

VARIOUS MANUFACTURERS
LENGTH: 42mm / 1.65"



DIAMETER: 22mm
DIVERTER

CC19003

VARIOUS MANUFACTURERS
LENGTH: 49mm / 1.93"



DIAMETER: 25mm

CC19002

FOR PRICE PFISTER
LENGTH: 50mm / 1.97"



DIAMETER: 25mm
PP OEM # 974-074
FITS VARIOUS MANUFACTURERS

CC19001

FOR PEGASUS
LENGTH: 50mm / 1.975"



PE11502

FOR HUNTINGTON
LENGTH: 51mm / 2.00"



OEM # ST5000
OPERATING STEM FOR CC19030

CC19031

FOR DELTA
LENGTH: 51mm / 2.00"



OEM # RP1991

DE10480

FOR AMERICAN STANDARD
LENGTH: 53mm / 2.09"



DIAMETER: 47mm
OEM # A954440-007A

AS10185

KEROX
LENGTH: 54mm / 2.12"



DIAMETER: 28mm
KEROX # K-28
FITS VARIOUS MANUFACTURERS

CC19069

SINGLE LEVER CARTRIDGES

FOR VOLA

LENGTH: 54mm / 2.12"



DIAMETER: 28mm
OEM # VR277K

CC19087

FOR PRICE PFISTER

LENGTH: 54mm / 2.12"



OEM # 900-022
FLOWMATIC CARTRIDGE

PP11702

FOR GERBER

LENGTH: 54mm / 2.125"



OEM # 97-022
SAFETEMP CONTROL CARTRIDGE

GE10782

FOR DANZE/GERBER/PEGASUS

LENGTH: 54mm / 2.135"



OEM # 603566

CC19056

FOR DANZE/GERBER/PEGASUS

LENGTH: 54mm / 2.135"



CC19056WS

FOR HUNTINGTON

LENGTH: 57mm / 2.25"



DIAMETER: 35mm
OEM # ST9000
FITS VARIOUS MANUFACTURERS

CC19006

FOR CONCINITY / JACLO

LENGTH: 57mm / 2.25"



DIAMETER: 35mm

CC19027

FOR KOHLER

LENGTH: 57mm / 2.25"



DIAMETER: 35mm
KOHLER # GP1016515
FITS VARIOUS MANUFACTURERS

CC19034

FOR GERBER

LENGTH: 57mm / 2.25"



DIAMETER: 35mm
GERBER # 92-298 / KEROX # K35A
FITS VARIOUS MANUFACTURERS

CC19050

SINGLE LEVER CARTRIDGES

KEROX
LENGTH: 57mm / 2.25"



DIAMETER: 35mm
FITS VARIOUS MANUFACTURERS
CC19050-LS

FOR VOLA
LENGTH: 57mm / 2.25"



DIAMETER: 35mm
OEM # VR1 277K
CC19086

FOR AMERICAN STANDARD
LENGTH: 57mm / 2.25"



DIAMETER: 47mm
OEM # 023529-0070A
AS10186

FOR AMERICAN STANDARD
LENGTH: 57mm / 2.25"



DIAMETER: 40mm
OEM # A951470-0070A
AS10188

FOR GERBER
LENGTH: 57mm / 2.25"



OEM # 97-142
EZ-MIX CARTRIDGE
GE10785

SINGLE LEVER CARTRIDGES

VARIOUS MANUFACTURERS
LENGTH: 58mm / 2.28"



DIAMETER: 35mm
JOYSTICK TYPE

CC19011

FOR CONCINITY
LENGTH: 58mm / 2.28"



DIAMETER: 35mm
OEM # 30820-24

CC19026

FOR WOLVERINE
LENGTH: 58mm / 2.28"



DIAMETER: 35mm
OEM # 85107W

CC19049

FOR KOHLER
LENGTH: 58mm / 2.28"

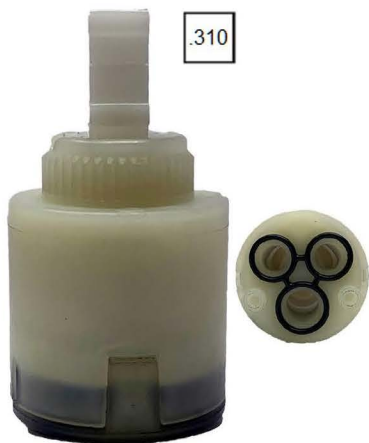

DIAMETER: 30mm
OEM # GP77548

CC19085

FOR VALLEY
LENGTH: 59mm / 2.31"



OEM # V6680

VA12248

FOR VALLEY
LENGTH: 60mm / 2.375"



OEM # VP1965
CARTRIDGE WITH SPRAY

VA12246

SINGLE LEVER CARTRIDGES

FOR VALLEY
LENGTH: 60mm / 2.375"



.310



OEM # VP1964
CARTRIDGE WITHOUT SPRAY
VA12247

VARIOUS MANUFACTURERS
LENGTH: 61mm / 2.40"



M6 X 1.00



DIAMETER: 40mm
JOYSTICK TYPE

CC19017

FOR PAIJO
LENGTH: 61mm / 2.40"



.365



DIAMETER: 25mm
FITS MANY MANUFACTURERS

CC19028

FOR GERBER
LENGTH: 61mm / 2.40"



20
3-20



DIAMETER: 40mm
OEM # 95-154

PBCV-CTG

KEROX
LENGTH: 62mm / 2.43"



20
3-20



DIAMETER: 35mm
KEROX # KDZ-35A
CERAMIC DIVERTER CARTRIDGE

CC19073

SINGLE LEVER CARTRIDGES

FOR SAYCO
LENGTH: 62mm / 2.44"



DIAMETER: 38mm
OEM # P1050
CC19042

FOR PRICE PFISTER
LENGTH: 62mm / 2.45"



OEM # 971-250
PP11697

FOR STERLING
LENGTH: 62mm / 2.45"



OEM # A05023
CARTRIDGE WITH DIVERTER
SL11982

FOR STERLING
LENGTH: 62mm / 2.45"



OEM # A05013
CARTRIDGE WITHOUT DIVERTER
SL11983

HYDROPLAST
LENGTH: 63mm / 2.46"



DIAMETER: 42mm
HYDROPLAST # C42
CC19095

SINGLE LEVER CARTRIDGES

FOR PRICE PFISTER
LENGTH: 63mm / 2.48"



DIAMETER: 35mm
OEM # 974-505 / 974-570

CC19037

FOR PRICE PFISTER
LENGTH: 63mm / 2.48"



DIAMETER: 35mm
OEM # 974-035

CC19038

KEROX
LENGTH: 63mm / 2.48"



DIAMETER: 40mm
KEROX # K40A
FITS MANY MANUFACTURERS

CC19044

FOR ZURN
LENGTH: 63mm / 2.48"



DIAMETER: 40mm
OEM # RK7440

CC19012

FOR DELTA
LENGTH: 63mm / 2.485"



DIAMETER: 36mm
OEM # RP50587

DE10485

HYDROPLAST
LENGTH: 64mm / 2.50"



DIAMETER: 40mm
HYDROPLAST # G40
FITS MANY MANUFACTURERS

CC19036

SINGLE LEVER CARTRIDGES

FOR HUNTINGTON BRASS
LENGTH: 63mm / 2.50"



DIAMETER: 40mm
WITHOUT MIXER
CC19058

KEROX
LENGTH: 67mm / 2.625"



DIAMETER: 35mm
KEROX # KJ-35A
CC19071

FOR MILWAUKEE
LENGTH: 67mm / 2.655"



OEM # R1005
MW11329

FOR STERLING
LENGTH: 69mm / 2.70"



OEM # 05300
SL11981

SINGLE LEVER CARTRIDGES

HYDROPLAST
LENGTH: 69mm / 2.72"



DIAMETER: 35mm
HYDROPLAST # BX35

CC19094

FOR PRICE PFISTER
LENGTH: 70mm / 2.75"



DIAMETER: 35mm
OEM # 974-092
FITS MANY MANUFACTURERS

CC19008

HYDROPLAST
LENGTH: 70mm / 2.75"



DIAMETER: 35mm
HYDROPLAST # GX35

CC19035

FOR AQUABRASS
LENGTH: 71mm / 2.78"



DIAMETER: 35mm
OEM # ABCA03240

CC19083

VARIOUS MANUFACTURERS
LENGTH: 71mm / 2.80"



DIAMETER: 35mm
JOYSTICK TYPE

CC19010

SINGLE LEVER CARTRIDGES

HYDROPLAST
LENGTH: 72mm / 2.85"



DIAMETER: 38mm
HYDROPLAST # AX38

CC19093

FOR MOEN
LENGTH: 72mm / 2.85"



DIAMETER: 35mm
MOEN # 194149 / KEROX # KDZ-35B
DIVERter CARTRIDGE

CC19096

FOR KOHLER
LENGTH: 72mm / 2.855"



OEM # GP30413

KO11183

KEROX
LENGTH: 73mm / 2.86"



DIAMETER: 35mm
KEROX # K-35B HWS
FITS MANY MANUFACTURERS

CC19070

KEROX
LENGTH: 73mm / 2.86"



DIAMETER: 35mm
KEROX # K-35B
FITS MANY MANUFACTURERS

CC19070-LS

VARIOUS MANUFACTURERS
LENGTH: 74mm / 2.90"



DIAMETER: 40mm

JOYSTICK TYPE

CC19016

SINGLE LEVER CARTRIDGES

VARIOUS MANUFACTURERS
LENGTH: 75mm / 2.95"

FOR GLACIER BAY/ PEGASUS
LENGTH: 75mm / 2.95"

FOR SAYCO
LENGTH: 76mm / 2.99"



DIAMETER: 40mm
IMPORT # JH02BD
CC19025



DIAMETER: 40mm
OEM # RP20006
CC19032



DIAMETER: 38mm
OEM # P1071
CC19040

KEROX
LENGTH: 76mm / 2.99"

KEROX
LENGTH: 76mm / 2.99"

FOR PROFLO
LENGTH: 76mm / 3.00"



DIAMETER: 40mm
KEROX # PBS40
CC19045

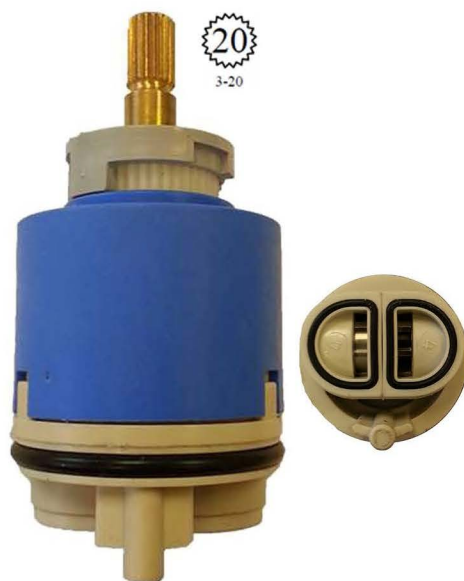

DIAMETER: 40mm
KEROX # PBR40
CC19046



DIAMETER: 40mm
OEM # ACF300CRT2 (LESS CHECK)
CC19107

SINGLE LEVER CARTRIDGES

VARIOUS MANUFACTURERS
LENGTH: 76mm / 3.00"

FOR MOEN
LENGTH: 76mm / 3.00"

FOR EZ-FLO
LENGTH: 78mm / 3.07"



DIAMETER: 40mm

CC19014



DIAMETER: 40mm

OEM # 121549 / KEROX # K40B
ALSO FITS VARIOUS MANUFACTURERS

CC19051



DIAMETER: 40mm

OEM # 90030 / IMPORT # JL02BJ
ALSO FITS VARIOUS MANUFACTURERS

CC19024

FOR SAYCO
LENGTH: 78mm / 3.07"

FOR ZURN
LENGTH: 79mm / 3.10"

VARIOUS MANUFACTURERS
LENGTH: 79mm / 3.11"



DIAMETER: 38mm
OEM # P1070

CC19039



DIAMETER: 40mm
OEM # RK7300-CART-3P / IMPORT # JH02BJ
ALSO FITS VARIOUS MANUFACTURERS

CC19025-OS



DIAMETER: 40mm
IMPORT # JL04BD

CC19023

SINGLE LEVER CARTRIDGES

FOR HUNTINGTON
LENGTH: 79mm / 3.12"



DIAMETER: 40mm
SPECIAL HUNTINGTON CARTRIDGE
WITH SMALLER .365 BROACH
CC19023SP

FOR HUNTINGTON
LENGTH: 79mm / 3.12"



DIAMETER: 40mm
OEM # ST7100 / IMPORT # JL01GJ
FITS VARIOUS MANUFACTURERS
CC19023-OS

FOR KOHLER
LENGTH: 80mm / 3.14"
M6 X 1.00



DIAMETER: 35mm
OEM # 1126312 / KEROX # KJ-35B
CC19072

FOR VARIOUS MANUFACTURERS
LENGTH: 80mm / 3.14"



DIAMETER: 40mm
IMPORT # JH01GJ
CC19079

FOR DELTA / PEERLESS
LENGTH: 80mm / 3.15"



DIAMETER: 40mm
OEM # RP70538
CC19054

VARIOUS MANUFACTURERS
LENGTH: 81mm / 3.20"



DIAMETER: 35mm
3-WAY DIVERTER CARTRIDGE
CC19080

SINGLE LEVER CARTRIDGES

VARIOUS MANUFACTURERS
LENGTH: 81mm / 3.20"



DIAMETER: 35mm
4-WAY DIVERTER CARTRIDGE
CC19081

FOR DELTA
LENGTH: 83mm / 3.25"



OEM # RP32104
DE10481

FOR DELTA
LENGTH: 83mm / 3.25"



OEM # RP46463
DE10483

FOR STERLING
LENGTH: 83mm / 3.25"

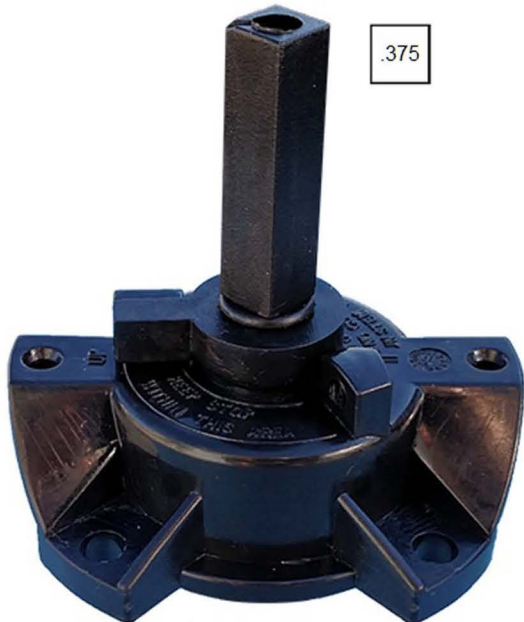

OEM # 05200
SL11980

FOR GLACIER BAY
LENGTH: 83mm / 3.27"

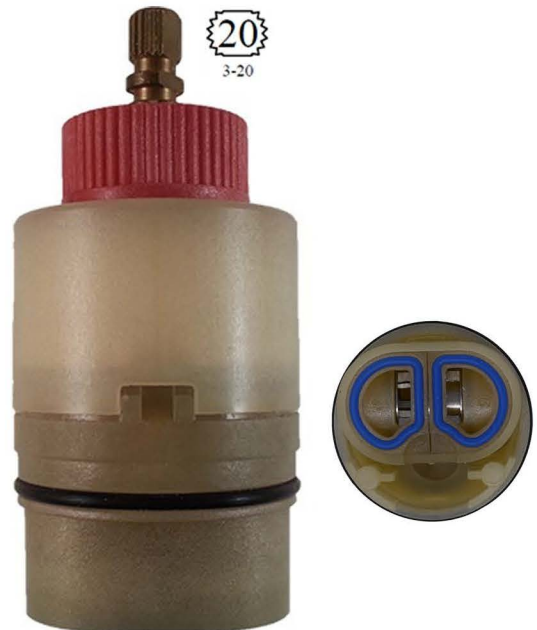

DIAMETER: 40mm
CC19033

SINGLE LEVER CARTRIDGES

FOR MOEN
LENGTH: 83mm / 3.27"



DIAMETER: 35mm
OEM # 163127
DIVERTER CARTRIDGE
CC19084

FOR WOLVERINE
LENGTH: 84mm / 3.30"



DIAMETER: 40mm
OEM # 85116
CC19048

VARIOUS MANUFACTURERS
LENGTH: 84mm / 3.30"



DIAMETER: 40mm
CC19076

FOR BRIZO (DELTA)
LENGTH: 85mm / 3.335"



DIAMETER: 45mm
OEM # RP75213
TUB FILLER CARTRIDGE
CC19074

SINGLE LEVER CARTRIDGES

FOR SAYCO
LENGTH: 85mm / 3.35"



DIAMETER: 40mm
OEM # R200CC

CC19041

FOR PROFLO
LENGTH: 85mm / 3.35"



DIAMETER: 40mm
OEM # ACF3001CRT

CC19047

FOR GERBER
LENGTH: 85mm / 3.35"



DIAMETER: 40mm
OEM # 95-154 / 95-152
FITS VARIOUS MANUFACTURERS

PBCV

FOR KOHLER
LENGTH: 86mm / 3.375"



OEM # GP77886
KO11181

SINGLE LEVER CARTRIDGES

FOR EZ-FLO
LENGTH: 87mm / 3.425"



DIAMETER: 40mm
FITS VARIOUS MANUFACTURERS
CC19015

FOR SAYCO
LENGTH: 88mm / 3.465"



DIAMETER: 38mm
OEM # P1079
CC19043

FOR HUNTINGTON
LENGTH: 89mm / 3.50"



DIAMETER: 47mm
OEM # ST5000C
CC19030

FOR DANZE / GERBER
LENGTH: 90mm / 3.55"



DIAMETER: 40mm
OEM # A507978
CC19061

SINGLE LEVER CARTRIDGES

VARIOUS MANUFACTURERS
LENGTH: 91mm / 3.58"

VARIOUS MANUFACTURERS
LENGTH: 92mm / 3.62"



DIAMETER: 40mm

CC19055



DIAMETER: 40mm

IMPORT # JHO4BD
WITH CHECK VALVE
CC19053

FOR KOHLER
LENGTH: 92mm / 3.65"

FOR DANZE
LENGTH: 96mm / 3.765"

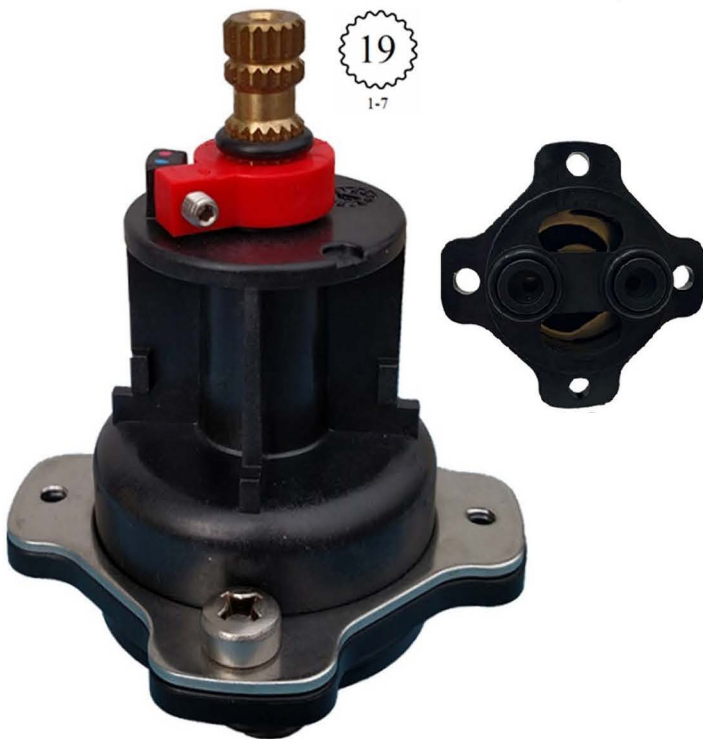

OEM # GP77759
KO11180



DIAMETER: 45mm
OEM # A507150
CC19068

SINGLE LEVER CARTRIDGES

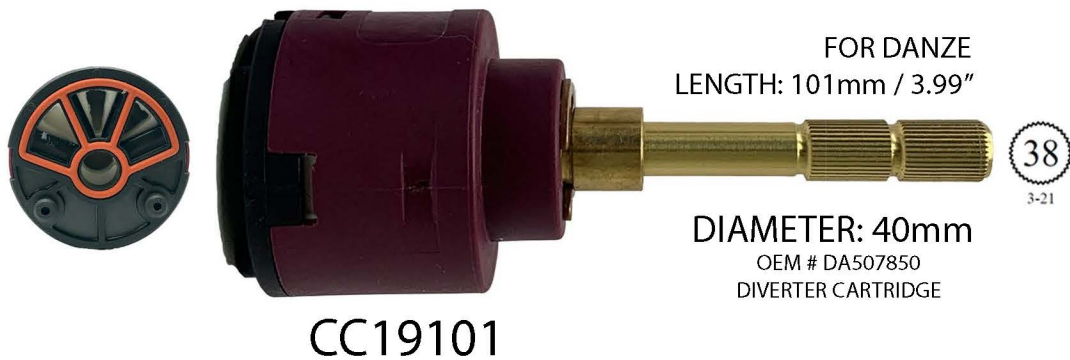
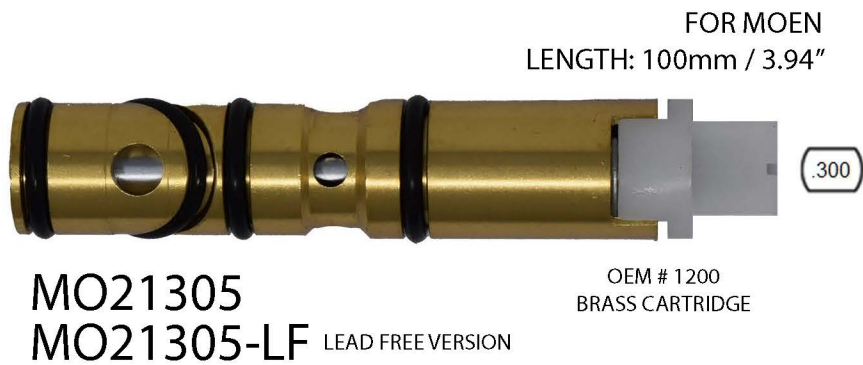

SINGLE LEVER CARTRIDGES

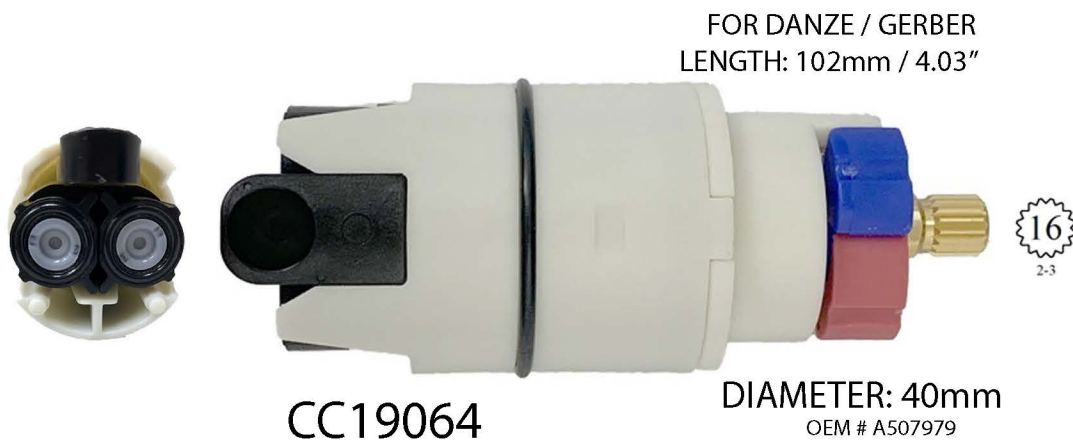

SINGLE LEVER CARTRIDGES

FOR NIBCO
LENGTH: 105mm / 4.125"



OEM # 85549 / N1300-5-0

NI11440

FOR MOEN
LENGTH: 105mm / 4.125"



OEM # 1222B
POSI-TEMP

MO21306

FOR PRICE PFISTER
LENGTH: 105mm / 4.125"



OEM # 974-292
AVANTE CARTRIDGE

PP11691

FOR GLACIER BAY
LENGTH: 405mm / 4.130"



3-20

CC19106

SINGLE LEVER CARTRIDGES

FOR PRICE PFISTER
LENGTH: 105mm / 4.13"



PP11698

OEM # 974-042

FOR PRICE PFISTER
LENGTH: 106mm / 4.165"

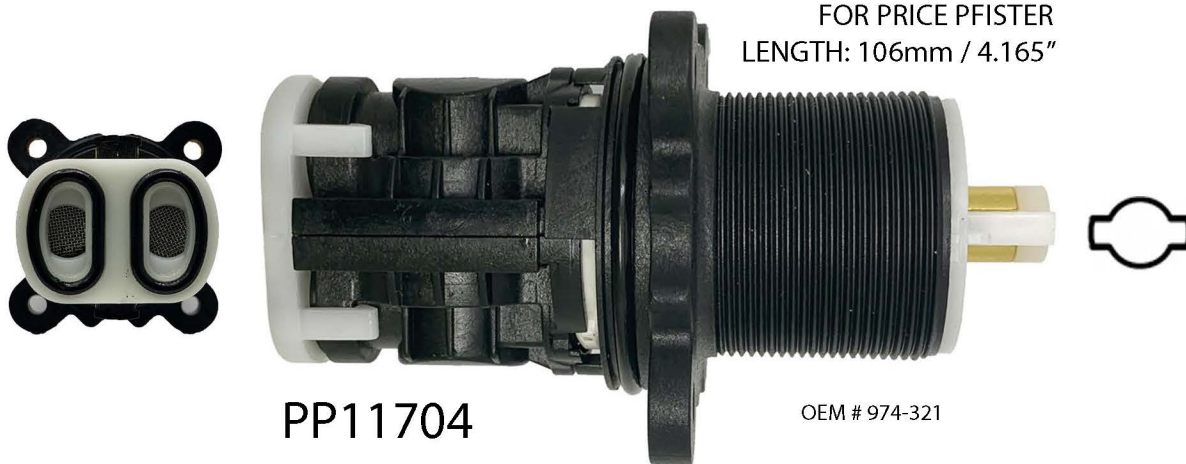

PP11704

OEM # 974-321

FOR GLACIER BAY & OTHERS
LENGTH: 106mm / 4.18"



CC19091

OEM # A507887

FOR DELTA
LENGTH: 110mm / 4.325"



DE10484

OEM # RP46074

SINGLE LEVER CARTRIDGES

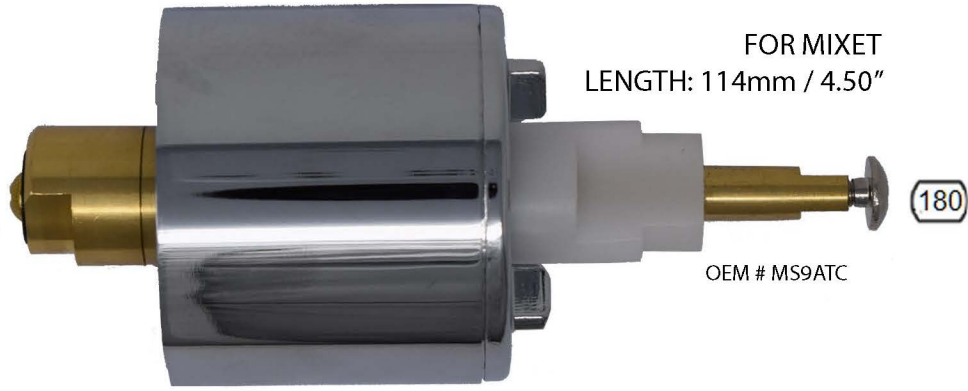

FOR MIXET
LENGTH: 114mm / 4.50"

OEM # MS9ATC

MX21354

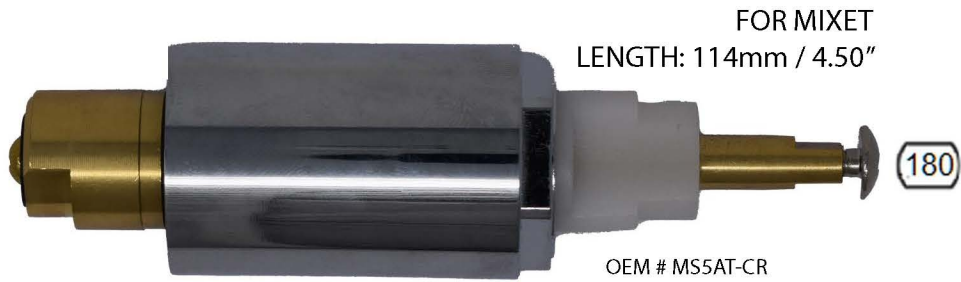

FOR MIXET
LENGTH: 114mm / 4.50"

OEM # MS5AT-CR

MX21348-B



FOR GERBER
LENGTH: 119mm / 4.68"

OEM # 97-014 / 97-022

GE10783

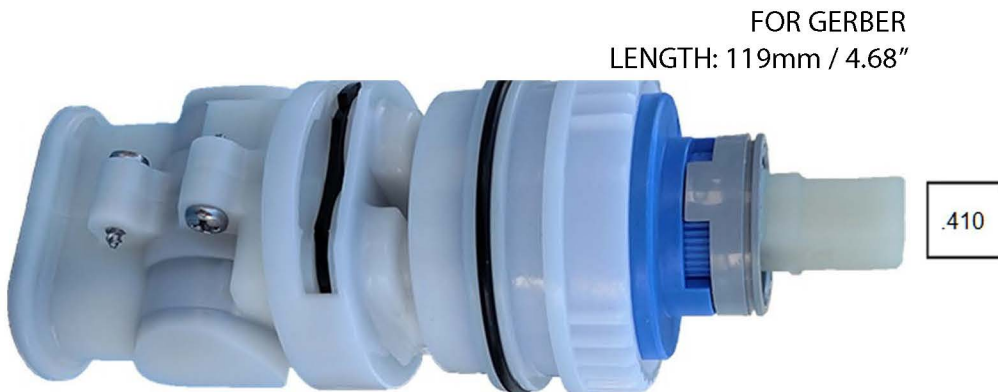

FOR GERBER
LENGTH: 119mm / 4.68"

OEM # 97-013 / 92-298

GE10784

SINGLE LEVER CARTRIDGES



FOR DANZE / GERBER
LENGTH: 126mm / 4.95"

.350

DIAMETER: 40mm
OEM # A507902

One Pin

CC19060



FOR DANZE / GERBER
LENGTH: 128mm / 5.025"

38
3-21

DIAMETER: 45mm
OEM # DA507107 / 97-232

CC19066



VARIOUS MANUFACTURERS
LENGTH: 130mm / 5.12"

.350

DIAMETER: 40mm

HL-40
10 16 14 09 42

CC19029

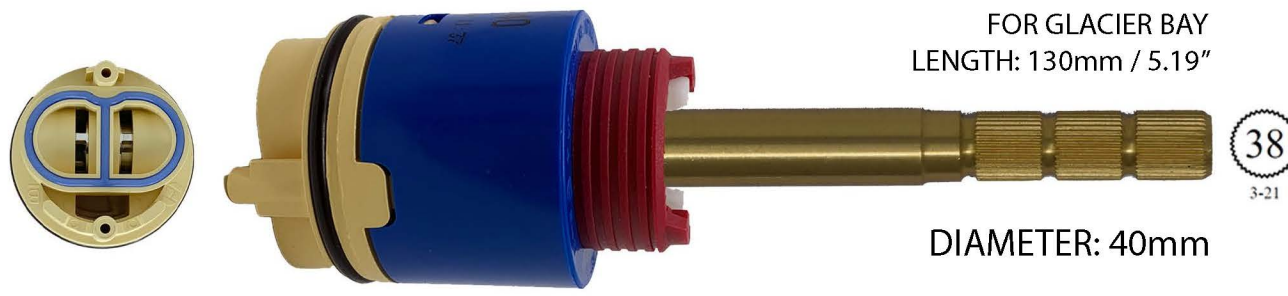

FOR GLACIER BAY
LENGTH: 130mm / 5.19"

38
3-21

DIAMETER: 40mm

CC19052

SINGLE LEVER CARTRIDGES

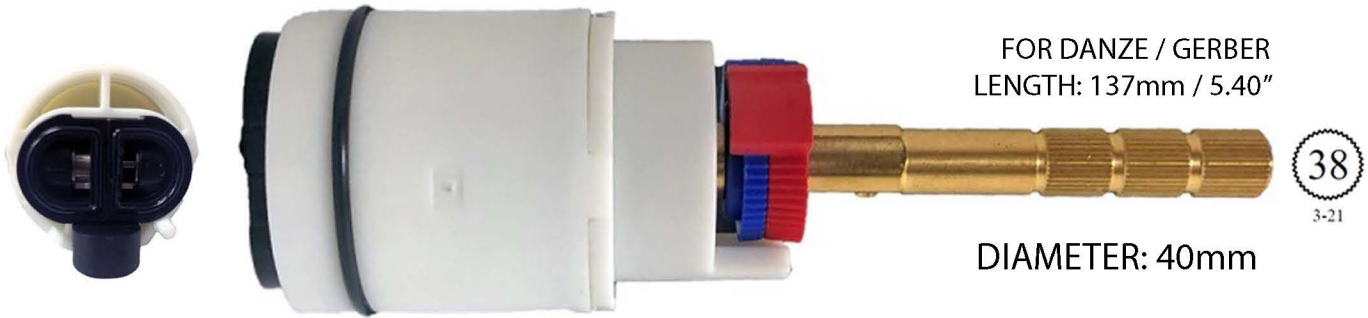

CC19062



CC19063



KO11184



CC19090

SINGLE LEVER CARTRIDGES



CC19077



CC19067



CC19065



CC19089

SINGLE LEVER CARTRIDGES



SINGLE LEVER CARTRIDGES

VARIOUS MANUFACTURERS
LENGTH: 192mm / 7.575"

FOR PHYLRICH
LENGTH: 195mm / 7.685"

FOR DANZE / GERBER
LENGTH: 165mm / 6.48"



.350



DIAMETER: 40mm
OEM # A507193
CC19088



20
3-20



DIAMETER: 40mm
CC19078



16
1-6



DIAMETER: 40mm
OEM # 1-130
CC19075