

The International 17th Nitrogen Workshop

was jointly organised by

Teagasc and AFBI



Printed by

Print Depot

Suggested citation

Authors, 2012. Title In: Richards, K.G., Fenton, O., Watson, C. J. (Eds). Proceedings of the 17th Nitrogen Workshop –Innovations for sustainable use of nitrogen resources. 26th – 29th June 2012, Wexford, Ireland, pp. nn-nn.

ISBN-10: 1-84170-588-8

Scientific Committee

KARL RICHARDS, TEAGASC
OWEN FENTON, TEAGASC
GARY LANIGAN, TEAGASC
DAVID WALL, TEAGASC
STAN LALOR, TEAGASC
JAMES HUMPHREYS, TEAGASC
ROGIER SCHULTE, TEAGASC
CATHERINE WATSON, AFBI
RONNIE LAUGHLIN, AFBI
JOHN BAILEY, AFBI

Organising Committee

CHAIRMAN: KARL RICHARDS, TEAGASC
OWEN FENTON, TEAGASC
CATHERINE WATSON, AFBI
MARY FOLEY, TEAGASC
JOHN BAILEY, AFBI
NIAV MILLER, CONFERENCE ORGANISERS LTD

Field Trip Committee

EU DAIRYMAN PROJECT: CATHAL MORAN, JAMES HUMPHREYS, ANDY BOLAND
JOHNSTOWN CASTLE: STAN LALOR AND GARY LANIGAN, TEAGASC
WETLANDS: RORY HARRINGTON WATERFORD COUNTY COUNCIL
CATCHMENT: COLIN DONOVAN, JOE RATH AND THE AGRICULTURAL CATCHMENTS TEAM

Acknowledgments:

We wish to thank all persons that made the 17th International Nitrogen Workshop possible. Special thanks to the organisers of the 16th Nitrogen workshop who assisted with the early planning and advised on their lessons learnt. To the invited speakers for their insightful paper contributions. To all the organisations that contributed financially to the workshop. A special word of thanks to the staff and students of Teagasc and AFBI for their valuable assistance. And finally to the participants of the Workshop for their contributions to making the 17th International Nitrogen Workshop successful.

The 17th International Nitrogen Workshop is sponsored by the OECD's Co-operative Research Programme on Biological Resource Management for Sustainable Agricultural Systems



OECD Disclaimer

The opinions expressed and arguments employed in this publication are the sole responsibility of the authors and do not necessarily reflect those of the OECD or of the governments of its Member countries.

OECD CRP Accreditation

The Workshop was sponsored by the OECD Co-operative Research Programme on Biological Resource Management for Sustainable Agricultural Systems, whose financial support made it possible for most of the invited speakers to participate in the Workshop.

The following organisations have also kindly supported the event:

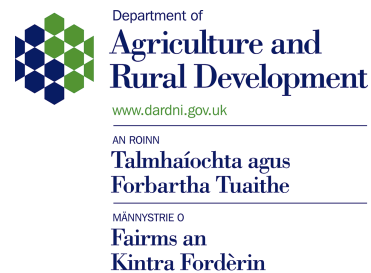
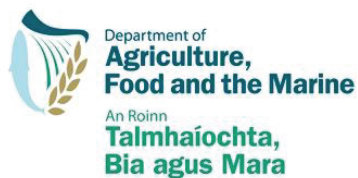

Dear Workshop Participant,

On behalf of the organising committee, it is my pleasure to welcome you to the 17th International Nitrogen Workshop “iNNovations for sustainable use of nitrogen resources”, held in the unique Wexford Opera House, Ireland from 26th to 29th June 2012. The workshop is jointly organised between Teagasc (the Irish Agriculture Food and Development Authority) and AFBI (Agri-Food and Biosciences Institute, Northern Ireland).

The first Nitrogen Workshop was in 1982 at Rothamsted, U.K. as a forum for researchers to exchange ideas and views on methodologies to investigate N transformations in agricultural systems. Over the past 30 years the workshop has become an international event focusing on a wide range of nitrogen topics including improving nitrogen use efficiency and responding to policies such as the Nitrates and Water Framework Directives.

The 17th International Nitrogen Workshop will focus on iNNovations for sustainable use of nitrogen resources and will cover new breakthroughs in science, knowledge transfer and management of nitrogen resources. The workshop provides a platform to discuss the nitrogen challenges and solutions for sustainable food production and is divided into four sessions:

- Advances in Understanding N-flows and Transformations
- A Holistic Approach to Understanding Impacts of Nitrogen on the Environment
- Global Perspectives on Nitrogen and Food Security
- Knowledge Transfer

Each of the N workshop sessions will address a central pertinent question:

- Where is the missing nitrogen?
- Which mitigation measures are synergistic/environmentally optimal?
- Will the cost of nitrogen threaten food security in the post-oil era?
- How can we bridge the gap between ever-more-detailed and narrow research and the knowledge requirements of our stakeholders?

A total of 31 oral papers and 196 poster papers are being presented at the workshop from 804 authors in 31 countries across 4 continents. The organising committee thank all authors for their written contributions to the proceedings and we look forward to your intellectual contribution through out the workshop. The financial support from all our sponsor organisations is gratefully acknowledged. We hope that you really enjoy both the Workshop and Wexford.



(Chairman of the Organising Committee)

TABLE OF CONTENTS

S.1.IP

Advances in Understanding N-flows and Transformations - Invited Presentations

- Advances in Understanding Nitrogen Flows and Transformations – Where is
the Missing Nitrogen? 2
C. Müller, T. J. Clough
- Can molecular analyses provide new understanding of past, present,
and future soil nitrogen dynamics? 11
M. Firestone, S. Blazewicz, D. G. Peterson, S. Placella

S.1.OP

Advances in Understanding N-flows and Transformations - Long Presentations

- Tracing of N Transformations in Soil and Gas Phases Using Isotopes and FTIR Spectroscopy 15
O. Kira, D. Haroush, R. Tzulker, Y. Dubowski, R. Linker, A. Shaviv
- Soil nitrogen transformations and N₂/N₂O emissions after application of slurry to Irish
grassland soils, as affected by the nitrification inhibitor DCD 17
*M. Ernfors, F. Brennan, K. McGeough, C. Mueller, R. Laughlin,
C. Watson, B. Griffiths, L. Philippot, K. Richards*
- The fate of urine nitrogen with use of a nitrification inhibitor 19
D. Selbie, K. Cameron, H. J. Di, J. Moir, G. Lanigan, K. Richards, R. Laughlin

S.1.SP

Advances in Understanding N-flows and Transformations - Short Presentations

- Search for the missing N: Excess N₂ in groundwater and streams 21
R. Fox, T. Fisher, A. Gustafson, T. Jordan, K. Knee, D. Brenner
- Characterising dissolved organic matter flux in UK freshwaters: Sources,
Transport and Delivery 23
C. Yates, P. Johnes, R. Spencer
- Investigating the efficacy of soil nitrogen tests to predict soil nitrogen supply across a range
of Irish soil types under controlled environmental conditions 25
N. McDonald, C. Watson, R. Laughlin, S. Lalor, N. Hoekstra, D. Wall

S.1.P

Advances in Understanding N-flows and Transformations - Posters

- A new approach for measuring ammonia volatilization in the field: First results of the
French research project "VOLAT'NH₃" 28
*J. Cohan, A. Charpiot, T. Morvan, P. Eveillard, R. Trochard, L. Champolivier,
E. de Chezelles, S. Espagnol, S. Genermont, B. Loubet*
- Ammonia volatilization after field application of biogas residues: model based scenario
analysis of crop specific emissions 30
A. Pacholski, D. Gericke, K. Ni, H. Kage
- Ammonia volatilization from banded urea: Impact of incorporation depth and
rate of application 32
P. Rochette, D. Angers, M. Chantigny, D. Pelster, N. Bertrand, M. Gasser
- Ammonia volatilization from crop residues - contribution to total ammonia
volatilization at national scale 34
F. de Ruijter, J. Huijsmans
- Antecedent effect of lime on denitrification in grassland soils 36
S. Higgins, R. Laughlin, C. Watson

Assessing N availability from municipal solid waste compost during two consecutive lettuce cycles in Italy <i>N. Fiorentino, M. Fagnano</i>	38
Assessment of the potential N mineralization/immobilization of pig slurry fractions obtained using different techniques <i>D. Fangueiro, C. Lopes, L. Olsen, E. Vasconcelos</i>	40
Biochar reduces nitrate leaching in an apple orchard <i>M. Ventura, G. Sorrenti, P. Panzacchi, G. Tonon</i>	42
Can an urease inhibitor mitigate N ₂ O and NO emissions from urea fertilized Mediterranean agrosystems? <i>A. Sanz-Cobeña, D. Abalos, T. Misselbrook, L. Garcia, A. Tellez, L. Sanchez, S. Garcia, A. Vallejo</i>	44
Can arbuscular mycorrhizal fungi enhance plant nitrogen capture from organic matter added to soil? <i>S. Saia, P. Ruisi, J. M. García-Garrido, E. Benítez, G. Amato, D. Giambalvo</i>	46
Canola Response to N Fertilization as Affected by Preceding Crop and Location <i>C. Grant, X. Gao, J. O'Donovan, B. J. Zebarth, R. Blackshaw, N. Harker, G. Lafond, E. Johnson, Y. Gan</i>	48
Carbon and nitrogen residual effects after repeated manure applications <i>D. Cavalli, L. Bechini, P. Marino</i>	50
Comparing N recovery from legumes grown as green manures in olive orchards <i>M. Arrobas, I. Ferreira, M. Claro, C. Correia, J. Moutinho-Pereira, E. Bacelar, A. Fernandes-Silva, M. Rodrigues</i>	52
Comparing strategies for implementing soil organic matter and nitrogen use in two contrasting soils <i>N. Fiorentino, C. Bertora, F. Alluvione, L. Zavattaro, M. Fagnano, F. Quaglietta Chiarandà, C. Grignani</i>	54
Comparison of APSIM and DNDC for simulating nitrogen transformation and N ₂ O emissions from urine patches <i>I. Vogeler, R. Cichota, D. Giltrap, V. Snow</i>	56

Determination of denitrification capacity of small headwater catchments in Flanders. <i>K. van Overtveld, M. Tits, A. Elsen, P. van de Vreken, J. van Orshoven, J. Vanderborght, J. Diels, O. Batelaan</i>	58
Differentiation between fungi and bacteria as a source of N ₂ O formation in soil <i>L. Rohe, R. Well, N. Wrage, T. Anderson, H. Flessa</i>	60
Do cover crops affect leaching and soil accumulation of salt and mineral N? <i>J. L. Gabriel, P. Almendros, M. Quemada</i>	62
Does groundwater level determine GHGs emissions from fertilized soil? <i>E. Cocco, F. Morari, C. Bertora, C. Grignani, G. Delle Vedove, R. Polese, A. Berti</i>	64
Dynamic of ammonia emission from urea spreading in Po Valley (Italy): relationship with nitrogen compounds in the soil <i>M. Carozzi, R. M. Ferrara, M. Acutis, G. Rana</i>	66
Dynamics of in situ nitrogen mineralization from five organic fertilizers <i>L. Costa, M. Costa, D. Pereira, C. Cordovil, A. de Varennes</i>	68
Effect of fertiliser type, rate and method of application on nitrogen leaching in organic olive oil farming <i>B. Gómez Muñoz, R. Bol, D. J. Hatch, R. García Ruiz</i>	70
Effect of long-term conservation and conventional tillage system on N ₂ O emissions under rainfed Mediterranean agro-ecosystem. <i>A. Tellez, S. Garcia, D. Abalos, L. Sanchez, A. Sanz-Cobeña, J. L. Tenorio, A. Vallejo</i>	72
Effect of N-fertilizer amount and nitrification inhibitor on N ₂ O emissions from a sandy and a loamy soil under vegetable production <i>P. Seiz, R. Schulz, A. Heger, M. Armbruster, F. Wiesler, T. Müller, R. Ruser</i>	74
Effect of nitrogen fertilizer amount and a nitrification inhibitor on the N ₂ O emissions from a loamy soil cropped with winter wheat <i>I. Guzman Bustamante, R. Schulz, T. Müller, R. Hähndel, R. Ruser</i>	76
Effect of soil compaction and nitrogen fertilization on nitrous oxide emission from highly productive grassland <i>R. Loges, M. Schmeer, F. Taube</i>	78
Effects of anaerobic digestion of organic manures on N turnover and N utilization <i>P. Sørensen, A. R. Khan, H. B. Møller, I. K. Thomsen</i>	80

Effects of arbuscular mycorrhizal symbiosis on the nitrogen uptake of three durum wheat genotypes from two different organic sources	82
<i>S. Saia, P. Ruisi, J. M. García-Garrido, G. Amato, D. Giambalvo</i>	
Effects of integrated weed management in cropping systems on soils, microbial activity and N ₂ O fluxes	84
<i>A. Vermue, L. Phillippot, N. Munier-Jolain, F. Bizouard, D. Bru, A. Coffin, C. Henault, B. Nicolardot</i>	
Effects of new catch crop and tillage systems on nitrogen management in sugar beet production	86
<i>E. Stavridou, O. Nielsen, H. L. Kristensen</i>	
Effects of overwinter vegetation cover on soil nitrogen supply to spring barley in Ireland	88
<i>R. Hackett</i>	
Effects of soil inoculation with arbuscular mycorrhizal fungi on plant growth and nutrient uptake of some Mediterranean species grown under rainfed field conditions	90
<i>S. Saia, P. Ruisi, G. Amato, G. Di Miceli, A. S. Frenda, D. Giambalvo</i>	
Effects of storage method on N disappearance and herbage N recovery from solid cattle manure	92
<i>G. M. Shah, E. A. Lantinga</i>	
Effects of urea fertilization with urease and nitrification inhibitors on ammonia volatilization and winter wheat yield	94
<i>K. Ni, A. Pacholski, H. Kage</i>	
Efficacy of ¹⁵ N nitrogen in fertilization of cereals – peas mixtures	96
<i>A. Rutkowska</i>	
Emissions of ammonia and nitrous oxide from liquid and solid fractions of treated pig slurry	98
<i>G. Velthof, E. Hummelink, O. Oenema</i>	
Estimating nitrate emissions to surface water: comparison of methods using detailed regional data and national-wide databases	100
<i>D. Rémi, C. Gascuel-Odoux, P. Durand, P. Virginie, M. Delmas, G. Deronzier, N. Domange</i>	
Evaluation of a closed tunnel for field-scale measurements of N ₂ O fluxes at the soil-atmosphere interface	102
<i>K. Schäfer, J. Böttcher, D. Weymann, C. Von Der Heide, W. Duijnsveld</i>	

Evaluation of nitrogen fertilisation and irrigation strategies to optimize yield, quality and benefit in peach trees	104
<i>J. M. Villar, M. Pascual, F. Fonseca, J. Lordan, A. Arbones, J. Rufat</i>	
Evidence of nitrate leaching hotspots over a vulnerable aquifer due to dry deposition of ammonia from poultry houses	106
<i>D. Seeton, S. Bittman, D. Hunt, M. Krzic, G. Kowalenko, B. Zebarth</i>	
Fertigation management of high density olive trees in calcareous soils	108
<i>J. Rufat, J. M. Villar, M. Pascual, F. Fonseca, N. Calonge, J. Lordan, A. Arbones</i>	
First-year's and residual herbage N recovery from fresh and composted solid cattle manures	110
<i>G. M. Shah, E. Lantinga</i>	
Forage yield and nitrogen utilization of forage maize hybrids in Organic Farming	112
<i>A. B. Monteagudo Diz</i>	
Gap filling of missing data for calculating the cumulated ammonia emission in a fertilized bare soil: a case study in Lombardia region (Italy)	114
<i>R. M. Ferrara, M. Carozzi, M. Acutis, N. Martinelli, G. Rana</i>	
Generation of N-balances to describe N-flows and N-transformations - The example of composting	116
<i>K. Ina, S. Rainer</i>	
Impact of point injection of ammonium fertilizer on nitrous oxide fluxes and nitrogen dynamics in soil	118
<i>M. Deppe, R. Well, M. Kücke, H. Flessa</i>	
Impact of quality of residue mulches and their decomposition on N dynamics in soil in conservation agriculture	120
<i>S. Recous, A. Iqbal, S. Aslam, G. Alavoine, P. Benoit, P. Garnier</i>	
Impact of two different types of grassland-to-field-conversion on nitrous oxide emission and nitrate leaching	122
<i>R. Greta, H. Mirjam, R. Well, F. Heinz</i>	
Improving N efficiency in barley through green manure management and biogas slurry	124
<i>R. B. Frøseth, A. K. Bakken, M. A. Bleken, H. Riley, K. Thorup-Kristensen, S. Hansen</i>	
Influence of fertilisation practice on gas and grain yield production	126
<i>A. Balint, S. Hoffmann, K. Berecz, K. Kristóf, G. Kampfl, E. Nótás, M. Horváth, B. Gyarmati, E. Molnár, A. Anton, T. Szili Kovács, G. Heltai</i>	

Influence of soil amendment history on decomposition of recently applied organic amendments	128
<i>L. Nett, S. Ruppel, J. Ruehlmann, E. George, M. Fink</i>	
Influence of N deposition and atmospheric O ₃ concentration on N ₂ O and NO emissions from Mediterranean pastures.	130
<i>L. Sanchez, A. de La Cruz, L. Garcia, H. Calvete, H. Garcia, I. Gonzalez, V. Bermejo, A. Vallejo</i>	
Influence of soil water status and compaction on N ₂ O and N ₂ emissions from ¹⁵ N-labelled synthetic urine.	132
<i>T. Harrison-Kirk, S. Thomas, M. Beare, T. Clough, T. van Der Weerden, E. Meenken</i>	
Influence of tree canopies on nitrogen dynamics in Montado - a Portuguese Cork Oak Savanna	134
<i>D. Fangueiro, M. D. C. Caldeira, X. Lecomte, J. Coutinho</i>	
Interactions between Free-living Soil Nematodes and Ryegrass and Effects on Nitrogen Mineralization	136
<i>M. Gebremikael, D. Buchan, S. de Neve</i>	
Ley management effects on N ₂ fixation, crop N dynamics and residual N	138
<i>S. Dahlin, M. Stenberg, H. Marstorp</i>	
Long-term effect of a nitrification inhibitor on N ₂ O fluxes from a loamy soil	140
<i>R. Ruser, H. Pfab, S. Rudolf, I. Palmer, S. Fiedler, F. Buegger, T. Müller</i>	
Maize stover incorporation increased N ₂ O emissions twofold during a barley crop	142
<i>D. Abalos, A. Sanz-Cobeña, L. Sanchez, A. Tellez, S. Garcia, A. Vallejo</i>	
Malting industry effluents as a source of nitrogen to soils	144
<i>H. Campaña, C. Cordovil, P. Benedetti, M. Uribe Etchevarría, A. Airasca, A. de Varennes</i>	
Managing nitrogen losses in shallow glacial aquifers: denitrifying bioreactors as a potential mitigation measure	146
<i>T. Ibrahim, O. Fenton, G. Lanigan, K. Richards, M. Healy</i>	
Methodology for the selection of the geographic location of new experimental sites and treatments to generate new N ₂ O emission factors and data for model validation in the UK: the prioritisation phase of the InveN ₂ Ory project.	148
<i>D. Chadwick, R. Olave, R. Laughlin, L. Cardenas, J. Williams, U. Skiba, B. Rees, S. Buckingham, K. Topp, S. Anthony</i>	

Model estimation of nitrogen leaching under derogation measures on organic nitrogen fertilization in Lombardia (northern Italy)	150
<i>A. Perego, E. Bernardoni, M. Carozzi, A. Giussani, S. Brenna, M. Acutis</i>	
Modelling the effects of temporal overlap of urine patches on nitrogen leaching	152
<i>R. Cichota, V. Snow</i>	
N availability from pre-treated chicken and goat manure in an organic cropping system	154
<i>K. Willekens, B. Reubens, B. Vandecasteele, A. Beeckman, L. Delanote, S. de Neve</i>	
N dynamics and priming effect in horticultural fields as influenced by application of mineral fertilizer N	156
<i>K. Willekens, B. Vandecasteele, S. de Neve</i>	
N fertiliser replacement value of reversed osmosis liquid fractions on arable land	158
<i>W. van Dijk, W. van Geel</i>	
N ₂ O and N ₂ production and quantification of denitrifying populations in various aquifer systems	160
<i>M. Barrett, M. M. R. Jahangir</i>	
N ₂ O emission from a maize cropping system influenced by replacing fallow with cover crops and its subsequent incorporation into the soil.	162
<i>S. Garcia, A. Sanz-Cobeña, J. L. Gabriel, P. Almendros, M. Quemada, A. Vallejo</i>	
Nitrate leaching after cattle slurry application to ley in autumn	164
<i>S. Delin, M. Stenberg, L. Engström</i>	
Nitrogen dynamics in agricultural Mediterranean catchments vs. temperate ones: Ebro, Oglio, Seine and Scheldt comparisons	166
<i>L. Lassaletta, M. Bartoli, G. Billen, J. Garnier, B. Grizzetti, E. Romero, E. Soana, P. Viaroli</i>	
Nitrogen dynamics in maize based cropping systems for biogas production	168
<i>K. Sieling, A. Herrmann, B. Wienforth, S. Ohl, F. Taube, H. Kage</i>	
Nitrogen losses from buffer zones: interactions with soil structure and hydrological pathways	170
<i>A. Carswell, M. Blackwell, R. Bol, D. Chadwick, J. Hawkins, P. Johnes, R. Whalley</i>	

Nitrogen mass balance in a coastal lowland declared vulnerable to nitrate (WFD 2000/60/EC): the relevance of secondary canals in excess nitrogen removal <i>G. Castaldelli, E. Pierobon, E. Soana, E. Salemi, V. G. Aschonitis, N. Colombani, M. Mastrocicco, M. Bartoli</i>	172
Nitrogen mineralization potential of soil amended with biochar from pig-slurry solids <i>R. Marchetti, F. Castelli, A. Orsi, L. Sghedoni</i>	174
Nitrogen mineralization potentials in rice-wheat systems in southeastern China <i>M. Hofmeier, M. Roelcke, H. Yong, Z. Cai, R. Nieder</i>	176
Nitrogen removal by fruits, leaves and pruning wood in a peach orchard <i>J. M. Villar, M. Pascual, F. Fonseca, J. Lordan, L. Villar, A. Arbones, J. Rufat</i>	178
Nitrogen sources and sinks in a heavily impacted watershed (Oglio River, Northern Italy) <i>A. Laini, E. Sacchi, E. Soana, C. A. Delconte, E. Racchetti, M. Bartoli, P. Viaroli</i>	180
Nitrous oxide emission from biogas production systems on a coastal marsh soil <i>A. Techow, K. Dittert, M. Senbayram, R. Quakernack, A. Pacholski, H. Kage, F. Taube, A. Herrmann</i>	182
Nitrous oxide emissions during the decomposition of summer cover crop residue under no-till <i>S. Giacomini, D. Weiler, L. Mendes Bastos, G. Dietrich, R. Schmatz, C. Aita</i>	184
Nitrous oxide emissions from a clay soil under mouldboard ploughing or tine cultivation <i>M. Stenberg, A. Kasimir Klemedtsson, J. Nylinder, P. Weslien, A. Myrbeck, J. Wetterlind, T. Rütting, L. Klemedtsson</i>	186
Nitrous oxide emissions from grassland treated with different types of manure: comparison between slurry plus fertilizer plots and farmyard manure plus fertilizer plots <i>A. Mori, M. Hojito</i>	188
Nitrous oxide emissions from two maizecrop seasons in northwestern Spain <i>A. Louro López, D. Báez Bernal, M. I. García Pomar, J. Castro</i>	190
Optimising the spring N fertilisation rate to winter oilseed rape <i>L. Engström</i>	192

Physicochemical changes and nitrogen losses during composting of <i>Acacia longifolia</i> and <i>Acacia melanoxylon</i>	194
<i>L. M. Brito, I. Mourão</i>	
Polyphenol and cellulose act as a nitrification inhibitor by different mechanisms	196
<i>H. Sabahi, R. Ali Hossein</i>	
Potential for N ₂ O emissions from volcanic grassland soils	198
<i>L. Cardenas, D. Scholefield, D. J. Hatch, D. Jhurreea, I. Clark, P. Hirsch, F. Salazar, S. Rao-Ravella, M. Alfaro</i>	
Prediction of mineral nitrogen content in deeper layers of soil in Lithuania based on its concentration in surface layers	200
<i>G. Staugaitis, J. Arbaciauskas, J. Mazvila, Z. Vaisvila, T. Adomaitis, L. Sasnauskaite, R. Staugaitiene, R. Mazeika</i>	
Regulatory effect of soil properties on N ₂ O emission from wheat-growing season in five soils: field and pot experiment	202
<i>U. Lebender, M. Senbayram</i>	
Response of corn (<i>Zea mays</i> L.) to precision injected dairy slurry with focus on nitrogen	204
<i>S. Bittman, D. Hunt, G. Kowalenko</i>	
Role of soil organic matter content on nitrogen dynamics in volcanic ash soils	206
<i>M. Alfaro, L. Cardenas, F. Salazar, A. Rosas, E. Vistoso, S. Hube, L. Ramirez</i>	
Seasonal variation of nitrous oxide emissions from grazed and fertilized grassland in Galicia (Spain)	208
<i>A. Louro López, D. Báez Bernal, M. I. García Pomar, J. Castro</i>	
Self-reseeding annual legume species as cover crops for rainfed olive orchards	210
<i>M. Rodrigues, I. Ferreira, M. Claro, J. Pires, M. Arrobas</i>	
Sensitivity of crop reflectance to crop N status of a melon crop	212
<i>M. T. Peña, R. Thompson, M. Gallardo, C. Gimenez</i>	
Sensitivity of the ratio leaf chlorophyll to leaf flavonoles measured with optical sensors to crop N status of melon	214
<i>M. T. Peña, R. Thompson, M. Gallardo, C. Gimenez</i>	
Site, preceding crop and N management effects on yield of organic winter oil seed rape	216
<i>L. Engström, M. Stenberg, A. Wallenhammar, P. Ståhl</i>	

Soil N ₂ O emission as affected by 3,5-Dimethylphirazolphosphate, an nitrification inhibitor, applied on different soil types in Southern Italy	218
<i>L. Vitale, F. Polimeno, L. Ottaiano, G. Maglione, A. Fierro, P. Di Tommasi, M. Mori, V. Magliulo</i>	
Soil Organic Matter Priming: effect of labile C on N mienralisation in Irish grassland soils	220
<i>C. Murphy, E. Baggs, N. Morley, E. Paterson, R. Schulte, D. Wall</i>	
Soil pH, and NO ₃ ⁻ concentrations regulates the N ₂ O and N ₂ emission from soil under anoxia	222
<i>M. Senbayram, L. R. Bakken, A. Budai, L. Marton, J. Lammel, U. Lebender</i>	
Spatiotemporal variation in groundwater nitrate-N concentrations in two agricultural catchments	224
<i>P. Mellander, A. Melland, P. Murphy, D. Wall, G. Shortle, P. Jordan</i>	
Strategies to reduce nitrous oxide emissions after spread of pig slurry in no-till corn and wheat	226
<i>C. Aita, J. Schurman, S. Giacomini, R. Gonzatto, J. Olivo, D. Giacomini</i>	
Study of the key factors which influence N ₂ O and CO ₂ emissions in a fertigation cropping system under Mediterranean climate	228
<i>D. Abalos, L. Sanchez, L. Garcia, A. Tellez, S. Garcia, A. Sanz-Cobeña, A. Vallejo</i>	
Synergetic leaching model based on pathway and pressure factors	230
<i>V. Kuzmanovski, S. Dzeroski, R. Schulte, M. Debeljak</i>	
Terrestrial carbon and nitrogen losses and indirect greenhouse gas emissions via groundwater	232
<i>M. M. R. Jahangir, P. Johnston, I. Khalil, D. Hennesey, J. Humphreys, O. Fenton, K. Richards</i>	
The complexity of the recharge processes and their effect on the seasonal variations of nitrate concentration in shallow groundwater and streams: observations and modeling	234
<i>L. Ruiz, P. Durand, M. Rouxel, C. Gascuel-Odoux, L. Aquilina, A. Aubert, M. Faucheux, P. Merot, J. Molenat, M. Sebilo</i>	
The effect of a mustard cover crop on groundwater denitrification	236
<i>M. M. R. Jahangir, E. Minet, P. Johnston, C. E. Coxon, R. Hackett, K. G. Richards</i>	
The effect of crop establishment system on the nitrogen use efficiency of cereal grain crops in Ireland.	238
<i>J. Brennan, T. McCabe, R. Hackett, P. D. Forristal</i>	

The effect of dicyandiamide addition to cattle slurry on rates of nitrification at a grassland site in Northern Ireland.	240
<i>K. McGeough, C. Mueller, R. Laughlin, C. Watson, M. Ernfors, E. Cahalan, K. Richards</i>	
The effect of mineral N fertiliser dose on nitrogen efficiency of silage maize	242
<i>J. Černý, J. Balík, M. Kulhánek, F. Vašák, L. Peklová, O. Sedlář, S. Shejbalová</i>	
The impact of crop rotation and N fertilization on the growth and yield of winter wheat	244
<i>E. Vári, P. Pepo</i>	
The interactions among the nitrogen supply and the physiological parameters and yield of winter wheat genotypes	246
<i>E. Szabó, P. Pepo</i>	
Using bromide as tracer to study the horizontal and vertical movement of nitrate under field conditions	248
<i>M. Almadni, E. Stockdale, J. Cooper</i>	
Winter wheat nitrogen demand under different soil conditions	250
<i>A. Krijger</i>	

S.2.IP

A Holistic Approach to Understanding Impacts of Nitrogen on the Environment - Invited Presentations

An integrated approach to reactive nitrogen in the environment	253
<i>M. A. Sutton</i>	
Integration of measures to mitigate reactive nitrogen loss to the environment	257
<i>C. A. M. de Klein, R. M. Monaghan, T. J. van Der Weerden, J. Chrystal</i>	

S.2.OP

A Holistic Approach to Understanding Impacts of Nitrogen on the Environment - Oral Presentations

Economic Cost of Nitrogen Management <i>O. Oenema, R. D. Condor, S. Gyldenkaerne, J. Oenema</i>	262
Beer, bread and other opportunities for innovation in nitrogen use <i>R. Sylvester-Bradley</i>	264
Using NDVI to define optimal N rate: an application on durum wheat <i>S. Loddo, F. Morari, L. Sartori, G. Mosca, A. Berti</i>	266

S.2.SP

A Holistic Approach to Understanding Impacts of Nitrogen on the Environment - Short Presentations

Processes of nitrate-N loss to streamflow from intensive cereal crop catchments in Ireland <i>A. Melland, P. Mellander, P. N. C. Murphy, D. P. Wall, S. Mehan, O. Shine, G. Shortle, P. Jordan</i>	268
GHG balance of bioenergy cropping systems under the environmental conditions of northern Germany <i>S. Claus, B. Wienforth, N. Svoboda, K. Sieling, H. Kage, M. Senbayram, K. Dittert, F. Taube, A. Herrmann</i>	270
Animal delivery of the nitrification inhibitor DCD as a new effective method for reducing nitrogen losses from grazed pastures <i>S. Ledgard, B. Welten, J. Luo</i>	272

S.2.P

A Holistic Approach to Understanding Impacts of Nitrogen on the Environment - Posters

- A synergistic mitigation technology for nitrate leaching and nitrous oxide emissions for pastoral agriculture 275
H. J. Di, K. Cameron, A. Roberts
- Agricultural measures has reduced the nitrogen surplus by almost 50% in Denmark 277
F. Vinther, C. D. Børgesen
- Ammonia emission after on-farm application of additives in pig slurry lagoons 279
M. Viguria, H. Arriaga, P. Merino
- Ammonia emissions from bovine slurries during storage 281
N. Rochford, G. Lanigan, S. Lalor, K. Byrne
- Ammonia volatilization losses from NBPT-treated urea stored under different conditions 283
J. Soares, H. Cantarella
- Assessment of national scale groundwater nitrate monitoring data as a basis for evaluating mitigation measures 285
K. Tedd, C. Coxon, D. Daly, M. Craig, B. Misstear
- Bedding additives reduce ammonia emissions during storage and after application of cattle straw manure, and improve N utilization by grassland 287
G. A. Shah, M. I. Rashid, J. C. J. Groot, P. W. G. Groot Koerkamp, E. A. Lantinga
- Can leguminous crops reduce nitrous oxide emissions? 289
V. Pappa, R. Thorman, G. Bennett, B. Rees, R. Sylvester-Bradley
- Characterization of indigenous rhizobial strains isolated from faba bean (*Vicia faba* L.) nodules 291
M. Blažinkov, S. Redžepović, N. Toth, S. Sikora, A. Stipetic
- Comparison between grass, leguminous and crucifer species used as cover crops 293
J. Ramírez-García, M. Ruiz, M. Quemada
- Consequences of long-term application of alternative N sources on gaseous emissions. 295
M. E. Calleja Cervantes, I. Irigoyen Iriarte, J. F. Cibriain Sabalza, B. Lasa Larrea, P. M. Aparicio Tejo, S. Menendez

Coupling long term database with SWAT and STICS models for testing models and simulating nitrogen management scenarios	297
<i>D. Mathieu, P. Nicolas, J. Huguet, C. Billy, J. Duval, C. Vandenberghe, N. Beaudoin, J. M. Marcoen</i>	
Determination of nitrogen concentration in pig slurries using NIR spectroscopy	299
<i>R. Fucella, G. Cabassi, P. Marino</i>	
Differentiating sewage and manure derived nitrate within surface waters	301
<i>C. Fenech, L. Rock, K. Nolan, A. Morrissey, J. Tobin</i>	
Differentiation of N application standards: does it help reconcile economy and environment?	303
<i>H. Ten Berge, W. van Dijk, S. Burgers, J. R. van Der Schoot</i>	
DMPP reduces N ₂ O losses and maintains wheat yield under humid Mediterranean conditions	305
<i>S. Menendez, X. Huerfano, A. Aizpurua, C. González-Murua, J. M. Estavillo</i>	
Effect of nitrogen fertilization on nitrate leaching in relation to grain yield response in Sweden	307
<i>S. Delin, M. Stenberg</i>	
Effect of non-fertilized winter grazing dairy production on soil N balances and soil N dynamics in a clay-loam soil	309
<i>M. Nepalova, P. Phelan, I. Casey, J. Humphreys</i>	
Effect of non-fertilized winter grazing dairy production system based on a clay-loam soil on N leaching to groundwater	311
<i>M. Nepalova, O. Fenton, I. Casey, J. Humphreys</i>	
Effect of ploughing and reseeded of permanent grassland on N leaching to groundwater and nitrous oxide emissions from a clay-loam soil	313
<i>M. Nepalova, I. Casey, J. Humphreys</i>	
Evaluating innovative farming systems to limit nitrogen diffuse pollution in catchments: development and application of the CASIMOD'N model	315
<i>P. Durand, P. Moreau, C. Baratte, P. Faverdin, C. Gascuel-Oudou, E. Ramat, J. Salmon-Monviola, L. Ruiz</i>	

Factors influencing the nitrate residue levels in Flemish agricultural soils: a statistical analysis of 8 years of nitrate measurements	317
<i>M. Tits, A. Elsen, D. Vandervelpen, J. Bries, H. Vandendriessche, K. van Overtveld, J. Diels</i>	
Farm N balances in European landscapes and the effect of measures to reduce N-losses	319
<i>T. Dalgaard, P. Durand, U. Dragosits, N. J. Hutchings, A. Kedziora, J. Bienkowski, A. Frumau, A. Bleeker, E. Magliulo, J. E. Olesen, B. Hansen, L. Thorling, M. R. Theobald, J. L. Drouet, P. Cellier</i>	
Food-based digestate quality and fertiliser value	321
<i>A. Rollett, M. Taylor, D. Tompkins, B. Chambers</i>	
Impact of the application of nitrogen from livestock manure on agricultural parcels on water quality: derogation in Flanders	323
<i>D. Vandervelpen, S. Maes, M. Tits, A. Elsen, J. Bries, H. Vandendriessche, K. van Overtveld, L. Peeters, O. Batelaan, J. van Orshoven, J. Vanderborght, J. Diels</i>	
Impact of timing of nitrogen fertilization at tillering stage on rice plant growth in intermittent water management.	325
<i>M. Martinez, M. D. M. Catala-Forner, E. Pla, N. Tomas-Navarro, D. Zhu</i>	
Improvement of sensor based N application approach in winter wheat by incorporation of soil and terrain properties	327
<i>S. Samborski, S. Dobers, D. Gozdowski, M. Stępień</i>	
Influence of agricultural practices and climate changes in Portuguese rice production	329
<i>N. Figueiredo, C. Carranca, H. Trindade, J. Pereira, A. Prazeres, R. Mano, P. Marques, A. Vargues</i>	
Influence of inter tillage on nitrate content in soil during tobacco crop growth	331
<i>F. Castelli, R. Marchetti, A. Orsi, L. Sghedoni</i>	
Irrigation and nitrogen fertiliser management effects on nitrate leaching losses from crop rotations	333
<i>S. Thomas, G. Francis, H. Waterland, R. Zyskowski, F. Tabley, R. Gillespie, J. Sharp, T. Fraser</i>	
Mitigating ammonia emissions from stored dairy cow manure	335
<i>T. van Der Weerden, J. Luo, M. Dexter</i>	

Modeling the effect of nitrogen management on nitrogen losses, net energy balance and plant quality in a wheat-rapeseed rotation	337
<i>P. Gallejones, A. Aizpurua, A. Del Prado</i>	
N fertilization and diazotrophic bacteria inoculation in sugarcane for bioenergy production	339
<i>H. Cantarella, Z. F. Montezano, G. J. C. Gava, R. Rossetto, A. C. Vitti, V. P. Vargas, J. Soares, C. A. Oliveira, H. A. W. Joris, O. T. Kölln, F. L. T. Dias, S. Urquiaga</i>	
N ₂ O emissions from Radiata Pine, Douglas fir and Beech forest stands in the Basque Country	341
<i>I. Barrena, J. M. Estavillo, M. Duñabeitia, P. Merino, C. González-Murua, S. Menendez</i>	
Nitrate leaching to the groundwater investigated for different management practices of organic farming and wine growing	343
<i>F. Feichtinger, A. Scheidl</i>	
Nitrogen balances of Swiss agriculture from 1975 to 2009	344
<i>E. Spiess</i>	
Nitrogen dynamics in soil amended with acidified and non acidified cattle slurry and derived liquid fraction	346
<i>D. Fangueiro, S. Surgy, J. Coutinho, F. Cabral</i>	
Nitrogen leaching and nitrous oxide emissions from grassland soils receiving dairy soiled water	348
<i>D. Minogue, P. French, T. Bolger, P. Murphy</i>	
Nitrogen use efficiency improvement in heavy-pig production in Northern Italy	350
<i>G. Della Casa, M. T. Pacchioli, R. Marchetti</i>	
Nitrogen use efficiency on dairy farms	352
<i>E. Mihailescu, P. Murphy, I. Casey, J. Humphreys</i>	
Nitrous oxide emission determining factors for a clay soil in Sweden	354
<i>J. Nylinder, A. Kasimir Klemetsson, M. Stenberg</i>	
Performance of nitrogen fertilizer rates for winter oilseed rape	356
<i>A. Ruza, Z. Gaile, O. Balodis, D. Kretia, M. Katamadze</i>	
Prediction of nitrous oxide emissions from Irish arable lands using the ECOSSE model	358
<i>M. I. Khalil, J. Smith, M. Abdalla, P. O'Brien, P. Smith, C. Mueller, M. Richards</i>	

Reducing N inputs and surpluses in baking wheat production by modifying the valuation system – an assessment of feasibility and potential in Germany <i>A. Techen, B. Osterburg</i>	360
Relations between management, economics and environmental quality on Dutch arable farms <i>C. Daatselaar, H. Prins, J. Reijjs</i>	362
Replacing lime with gypsum as fertiliser filler in calcium ammonium nitrate (CAN): a strategy for minimising nitrogen losses to the environment <i>J. Bailey</i>	364
Response of a range of forage swards to slurry nitrogen <i>A. Dale, A. S. Laidlaw, J. S. Bailey</i>	366
Temporal dynamics of soil N mineralization during an oilseed rape (<i>Brassica napus</i> L.) growth cycle in one season's growth under humid Mediterranean conditions <i>N. Villar, P. Gallejones, A. Castellón, G. Besga, A. Aizpurua</i>	368
The effect of measures implemented from 2003 to 2007 to reduce Nitrogen leaching from agricultural land in Denmark <i>C. D. Børgesen, F. P. Vinther</i>	370
The Environmental Virtual Observatory (EVO): can cloud-based modelling provide new understanding of nutrient cycling processes from catchment to national scale? <i>S. Greene, P. J. Jones, J. Freer, N. O'Doni, J. Bloomfield, S. Reaney, C. J. A. McLeod</i>	372
The use of Integrated Constructed Wetlands (ICW) in the management of nitrogen (N) enriched effluents. <i>R. Harrington, P. Carroll, R. McInnes, M. Everard, C. Harrington</i>	374
Tools to improve N cycle models <i>K. Betteridge, F. Li, D. C. Costall</i>	375
Use of a systems model to estimate the impact of management decisions on nitrate leaching under intensive cropping <i>J. Sharp, S. Thomas, T. Fraser, H. Brown</i>	377
Use of chemical amendment of dairy cattle slurry to reduce phosphorus losses from dairy cattle slurry while allowing land spreading of slurry to meet nitrogen requirements. <i>R. Brennan, M. Healy, G. Lanigan, O. Fenton</i>	379

- Using the Eurotate_N crop model to optimize nitrogen fertilization in potato crop 381
L. Olasolo, N. Vázquez García, M. L. Suso, A. Pardo

S.3.IP

Global Perspectives on Nitrogen and Food Security - Invited Presentations

- The Challenges of Feeding 9-10 Billion People - Sustainably & Equitably 384
H. C. J. Godfray
- Nitrogen and food security in the EU from a global perspective 392
H. J. M. van Grinsven, H. J. Westhoek, A. F. Bouwman, J. W. Erisman

S.3.OP

Global Perspectives on Nitrogen and Food Security - Long Presentations

- The Nitrogen footprint of European food production 398
J. P. Lesschen, A. Leip, S. Wagner, H. Westhoek, O. Oenema
- The product carbon footprint of milk from pasture- and confinement-based dairy farming 400
S. Philipp, T. Biegemann, M. Kamper, R. Loges, F. Taube

S.3.SP

Global Perspectives on Nitrogen and Food Security - Short Presentations

- The effect of nitrogen fertiliser application rate on nitrous oxide emission intensities
of arable crop products 402
*R. Thorman, V. Pappa, K. Smith, B. Rees, M. Chauhan, G. Bennett, P. Denton,
D. Munro, R. Sylvester-Bradley*

Carbon footprint of Irish milk production: can white clover make a difference? 404
M. Yan, J. Humphreys, N. Holden

Integrated assessment of nutrient management options in the food chain of China 406
L. Ma, F. H. Wang, W. F. Zhang, W. Q. Ma, G. Velthof, W. Qin, O. Oenema, F. Zhang

S.3.P

Global Perspectives on Nitrogen and Food Security - Posters

Carbon footprint of Irish milk production 409
M. Yan, J. Humphreys, N. Holden

Effect of nitrogen fertilizer application timing on yield of winter wheat in Ireland 411
A. Efreteui, M. Gooding, E. White, R. Hackett, J. Spink

Effect of Organic and Inorganic Nitrogen fertilizer and Plant Densities on Yield and Quality of Sugar beet 413
E. Refaie, E. A. Mahmoud, M. A. Hassanin

How does sheep grazing affect the greenhouse gas balance of a grazed steppe ecosystem? 415
S. Philipp, B. Wolf, M. Wiesmeier, U. Dickhofer, H. Wan, M. Gierus, K. Butterbach-Bahl, A. Susenbeth, F. Taube

Influence of different nitrogen fertilizers on forage maize yield and quality 417
M. I. García Pomar, D. Báez Bernal, A. Louro López, J. Castro

Nitrate metabolism in leaves of lettuce plants grown in floating system with different nitrate concentrations 419
N. Podetta, A. Ferrante

Reducing Nitrogen in a High-Input Chinese Double-Cropping System – Effects on Yield, Soil Nitrogen and Mineralisation 421
T. Hartmann, R. Schulz, T. Muller, X. P. Chen, F. S. Zhang

Soilless cultivation of vegetables in The Netherlands to reduce nitrogen emissions 423
D. H. Janjo, E. van Os, M. Blind, V. John

The influence of locally injected nitrogen fertilizer (CULTAN) on seed yield of winter rape and grain yield of spring barley in the Czech Republic 425
L. Peklova, O. Sedlar, J. Balik, O. Kozlousky, K. Kubesova

S.4.IP

Knowledge Transfer - Invited Presentations

- Effective stakeholder communication: together we stand, divided we fall! 428
H. F. M. Aarts, J. Humphreys, A. Le Gall
- Extension & Knowledge Transfer; Effective Partnerships for Timely Impact 432
Q. Ketterings, K. Czymmek

S.4.OP

Knowledge Transfer - Long Presentations

- A framework for designing and evaluating nitrogen-efficient farming systems at the catchment scale by combining process studies, integrated modelling and participatory approach. 437
P. Durand, L. Ruiz, L. Delaby, P. Moreau, L. Hubert-Moy, C. Gascuel-Oudou
- Estimating the effect of mitigation methods on multiple environmental pollutants 439
P. Newell Price, D. Harris, D. R. Chadwick, S. G. Anthony, R. D. Gooday, M. Taylor, J. R. Williams, B. J. Chambers

S.4.SP

Knowledge Transfer - Short Presentations

- Achieving good water quality status in intensive animal production areas: a LIFE+ project 441
E. Bortolazzo, M. Ligabue, M. T. Pacchioli, P. Mantovi
- Nitirsoil: a new N-model to estimate monthly nitrogen soil balance in irrigated agriculture. 443
J. M. de Paz, C. Ramos, F. Visconti
- Strategies to reduce N losses to water from agriculture: experiences from on-farm case studies in the N-TOOLBOX project 445
J. Cooper, K. Gascoyne, J. Kidd, H. Kristensen, M. Maturano, M. Quemada, G. van Der Burgt

S.4.P

Knowledge Transfer - Posters

"Reliquat Virtuel" : a new decision support tool to predict the soil inorganic N pool <i>N. Damay, C. Le Roux, J. Gaillard, J. MacHet</i>	448
Ammonium nutrition affects the accumulation of winter wheat glutenins <i>T. Fuertes Mendizabal, J. Gonzalez, L. M. Arregui, C. González-Murua, J. M. Estavillo, M. B. González Moro</i>	450
Automating fertiliser N management <i>D. Kindred, R. Sylvester-Bradley</i>	452
Comparing the efficiency of CAN, urea and urea + agrotain (n-butyl thiophosphoric triamide) as N fertiliser in grassland <i>D. Antille, N. Hoekstra, S. Lalor</i>	454
Effect of a green compost extract added to rabbit feed on nitrogen balance and ammonia and nitrous oxide emissions from stored slurry <i>E. Dinuccio, D. Biagini, R. Rosato, P. Balsari, C. Lazzaroni, E. Montoneri</i>	456
Effect of grapevine canopy management on petiole nitrogen and must amino acids contents of dryland Chardonnay grapes <i>M. Pascual, J. M. Villar, F. Fonseca, J. Rufat, J. Lordan, J. Astrain, J. Papió</i>	458
Effect of nitrogen fertilizer rate on wheat flour extensibility <i>J. Gonzalez, A. Ezquerria, J. Goñi, L. M. Arregui</i>	460
Effect of pretreatment on estimation of slurry composition by NIR spectroscopy with different probes <i>A. Finzi, R. Oberti, A. S. Negri, F. Perazzolo, G. Cocolo, G. Cabassi, G. Provolo</i>	462
Enhanced biological nitrogen fixation in grassland swards for soil Nitrogen management <i>G. McCollum, D. Nelson, J. Rao</i>	464
Fertigation techniques to increase the nitrogen use efficiency of slurries <i>P. Mantovi, E. Bortolazzo, A. Battilani</i>	466
Online Farm Nutrient Management Calculators <i>G. Mathers, E. Chisholm, M. Browne, G. McCarney</i>	468

Plant analytical tool for nitrogen N detection status in potato crop <i>A. Filipović, M. Poljak</i>	470
Potential indicators based on leaf flavonoids content for the evaluation of potato crop nitrogen status <i>B. A. Ferial, G. Jean-Pierre</i>	472
Quantitative evaluation of hot water extractable organic matter of organic farm soils in Japan by measurement of chemical oxygen demand with inexpensive chemicals and equipment <i>K. Kanazawa, S. Takahashi, M. Komada, N. Kato</i>	474
Satellite data potential for assessing potato crop nitrogen status at a specific field scale <i>G. Jean-Pierre, L. van Den Wyngaert, D. Buffet, A. Leonard, P. Defourny</i>	476
Sharing scientists' and stakeholders' knowledge in a DSS to reduce nitrogen losses in cropping systems <i>P. Virginie, R. Reau, P. Dubrulle, C. Aubert, A. Baillet, N. Beaudoin, P. Beguin, F. Butler, P. Cannavo, J. Cohan, A. Dupont, R. Duval, S. Espagnol, J. P. Fagniez, F. Flenet, L. Fourrie, S. Genermont, L. Guichard, M. Jeuffroy, E. Justes, F. Laurent, J. MacHet, F. Maupas, T. Morvan, S. Pellerin, C. Raison, C. Raynal, S. Recous, J. Thiard</i>	478
Soil quality as affected by organic and mineral N fertilization in maize <i>A. Biau, I. Mijangos, J. Lloveras</i>	480
The rice crop response to pig slurry fertilization in Ebro Delta area (Catalonia, Spain): four seasons studied (2008-2011). <i>M. M. Català, E. Pla, M. Martinez, N. Tomas-Navarro</i>	482
Using canopy reflectance to determine appropriate rate of topdress N in potatoes <i>F. K. van Evert, D. D. A. van Der Schans, J. T. Malda, W. van Den Berg, W. van Geel, J. N. Jukema</i>	484
Using data management systems to facilitate better nutrient management planning on Irish farms <i>S. Mechan, S. Lalor, O. Shine, P. Jordan, D. Wall</i>	486

1 SESSION

Advances in Understanding Nflows and Transformations

Oral Presentations

Advances in understanding nitrogen flows and transformations where is the missing nitrogen?

Müller, C.^{a,b} and Clough, T.J.^c

^aDepartment of Plant Ecology, Justus-Liebig-University Giessen, Germany

^bSchool of Biology and Environmental Science, University College Dublin, Ireland

^cFaculty of Agriculture and Life Sciences, Lincoln University, New Zealand

Nitrogen transformations and balances: gaps and research pathways

1. Introduction

Anthropogenically generated reactive nitrogen (N) cascades throughout the global environment (Galloway and Cowling, 2002). This reactive N may be lost from ecosystems via leaching, as nitrate (NO_3^-), or in gaseous forms such as ammonia and nitrous oxide (N_2O). These N losses are of significant importance both economically and environmentally. Despite more than 150 years of N cycling research by well known scientists such as Liebig (van der Ploeg et al., 1999), Bausingault (Aulie, 1970), Winogradsky (Ackert, 2006) and others there are still significant questions to be addressed with respect to N transformations and losses from terrestrial ecosystems.

Plant effects

Plant-soil interactions are an area of research attracting increasing interest with respect to N cycling. They are predominantly governed by interactions between the carbon (C) and N cycles. The microbial loop in soil is driven by recent plant C inputs (e.g. rhizodeposition) which influences the microbial activity in soils and ecosystem N availability is controlled by the initial chemical composition and litter N concentrations (Manzoni et al., 2008; Parton et al., 2007). In the rhizosphere, potential N transformations such as denitrification decrease rapidly in the first few millimetres of roots (Beauchamp et al., 1989). Thus soil aggregate-microsite reactions and the influence of roots are likely to cause small-scale variations of substrate availability and environmental regulators and prompt for a diverse reaction of the microbial community (Barnard et al., 2005).

Nitrogen cycling is closely associated with plant productivity and factors affecting it. For example, conditions that favour plant C assimilation may also enhance rhizodeposition and subsequently alter microbial community composition and function with subsequent effects on N cycling. Conversely, a higher demand for N by plants, that may occur as a result of environmental change, e.g. favourable growth temperatures, increases competition for N between plants and microbes, potentially affecting microbial community structures and subsequent N transformations in the soil (Zak et al., 2003). However, only few studies have examined the links between the N cycle, plant activity and associated changes in microbial form and function that affect N transformations and fluxes. In N-limited systems, the gross N transformation rates and not the sizes of the soil N pools govern the availability of N for plants and microbes (Rastetter et al., 1997).

Plants utilise mineral N (e.g. NH_4^+ or NO_3^-) and low molecular organic N compounds. The latter enter the soil via rhizodeposition (amino acids etc.) or are made available following microbial mineralization of organic material. Organic N (dissolved organic nitrogen, DON) uptake is reported to be more significant under conditions of N limitation and low pH (Jones et al., 2004). Despite the significance of DON as a loss pathway in agricultural ecosystems (Van Kessel et al., 2009) current knowledge of the organic N forms utilized by plants, with respect to DON dynamics over time and

space in the soil, and their rates of production and utilization is still limited. Similarly, the role DON plays in gaseous N loss pathways is also under researched. A recent review indicates that nitrosation reactions may be an important loss pathway for gaseous N (Spott et al., 2011).

Rhizodeposition stimulates microbial biomass growth and N turnover (Knops et al., 2002), which further stimulates the growth of predating organisms such as protozoa and nematodes (Osler and Sommerkorn, 2007; Sanderman and Amundson, 2003). Thus soil organic matter (SOM) is mineralized and decomposition of SOM may even be accelerated (priming). So far a quantitative evaluation of the various and simultaneously occurring N transformations, that lead to mineralization and immobilization of N in the rhizosphere is lacking. Can plants actively control exudation to create conditions in the rhizosphere to maximize the availability of N? Do plants actively produce compounds that deter non-beneficial organisms/pathogens directly or indirectly via relationships along trophic levels that in turn affect N cycling? Rhizodeposition of C compounds can directly influence N cycling, for instance enhancing N₂O emissions in the presence of an N substrate (Uchida et al., 2011). But relatively little is known about the forms and rates of C released.

N loss from ecosystems – the importance of denitrification

A major loss pathway for N to be released into the environment is via leaching as NO₃⁻. To be rendered environmentally benign this NO₃⁻ must be reduced to a non-reactive form, dinitrogen (N₂). Three major biological pathways of NO₃⁻ reduction are known: i) assimilatory NO₃⁻ reduction into biomass, ii) dissimilatory NO₃⁻ reduction to NH₄⁺ (DNRA) and iii) dissimilatory NO₃⁻ reduction to N₂ (denitrification) (Burger and Jackson, 2004; Robertson and Kuenen, 1990). DNRA may outcompete denitrification under conditions when electron acceptors are limited and provides an energetically favourable alternative to denitrification (Rütting et al., 2011; Tiedje, 1988). However, further research is still required to understand the importance of DNRA in terrestrial systems and to perfect methods for studying the process (Rütting et al., 2011).

Denitrification is a key transformation process in soils with adverse and beneficial roles, since it impairs N use efficiency of agricultural crops, is both a source and sink for N₂O, and lowers the potential for NO₃⁻ leaching to aquatic systems (Davidson and Seitzinger, 2006). Denitrification is a heterotrophic process performed by facultative anaerobic organisms that utilize various C substrates as electron donors (Beauchamp et al., 1989). In aquatic systems, autotrophic denitrification may also occur in the presence of inorganic electron donors like sulphides or ferrous iron (Clément et al., 2005; Knowles, 1982).

The reductases involved in denitrification are well recognized. The membrane bound nitrate reductase (Nar) is the first in the denitrification sequence and occurs in very diverse microbial communities including *a*, *b*, *g*, and *e* proteobacteria, gram positive bacteria and archaea (Philippot, 2005) while the periplasmic NO₃⁻ reductase (Nap) occurs only in gram-negative bacteria (Philippot, 2005). The key enzyme and key precursor for gaseous N emissions in the denitrification sequence is nitrite reductase which is encoded by either *nirS*, a cytochrome *cd1* containing gene, or *nirK*, a copper containing gene. The two nitrite reductases provide a functional marker for the diversity of denitrifying bacteria (Braker et al., 2000). The genes *norB* and *nosZ* encode the NO and N₂O reductase respectively (Groffman et al., 2006) and it is the dynamics of these two reductases in relationship to substrate and environmental regulators and in particular the balance between *nar/nir* and *nos* which controls the net production and release of N₂O. Philippot et al. (Philippot et al.,

2011) showed that denitrifiers with and without *nosZ* encoding can co-exist and that higher N_2O/N_2 ratios can be related to the proportions of bacteria with and without *nosZ* encoding. Differential encoding may also be related to soil pH which may differ in distinct niches (Philippot et al., 2009). This highlights the fact that the observed overall denitrification dynamic is governed by the sum of the individual dynamics of co-existing microbes, possibly living in different niches (Philippot et al., 2011) and/or soil aggregates (Miller et al., 2009). Soil aggregate size also influences the rate of denitrification despite denitrification activity and denitrifier abundance not being associated at the aggregate level (Miller et al., 2009). Moreover, aggregation affects diffusive exchange of N_2O and O_2 between denitrifying microsite and inter-aggregate pores, which affects both, total denitrification (Sexstone et al., 1985) and the product ratio of denitrification (Arah and Smith, 1989).

While available organic C and oxygen have a major impact on total denitrification, soil pH influences mainly the ratio of N_2O/N_2 (Šimek and Cooper, 2002). Maximum denitrification occurs usually at highest pH values and a linear relationship is often observed between denitrification and pH (Focht, 1974). There is a tendency that the N_2O/N_2 ratio increases with decreasing pH (Burford and Bremner, 1975; Liu et al., 2010; Šimek and Cooper, 2002) and a more complete reduction towards N_2 is found at higher pH values (Nõmmik, 1956). The effect of pH may be due to an impact on substrate availability which influences membrane permeability or speciation of chemical species (Dassonville and Renault, 2002). N_2O reductase is more sensitive to pH than other reductases in the denitrification sequence and therefore low pH may increase the lag phase of de novo synthesis of this enzyme (Liu et al., 2010; Šimek and Cooper, 2002). Apparently the detrimental effect of low pH on N_2O reductase occurs at the post-transcriptional level by interfering with translation, protein assembly or an effect on the activity of functional enzymes (Liu et al., 2010). Microsite variations in soil pH may support a diverse microbial community which exhibits a different sensitivity to pH (Cavigelli and Robertson, 2000; Šimek and Cooper, 2002). Also chemodenitrification may play a role for N_2O and N_2 production in acidic microsites (Chalk and Smith, 1983; Stevens et al., 1998). At pH below 3 chemical decomposition of NO_2^- is most likely the dominant process for N_2 production and may account for up 50% of N losses in tropical soils (Laudelout et al., 1977). Denitrifiers adapt to low pH over long periods of time, thus experimental setups including ad hoc pH manipulations are not conducive to evaluate natural soil conditions (Šimek and Cooper, 2002).

Microbial community dynamics

Microbial community dynamics are influenced by the interacting effect of environmental conditions together with the substrate relationships (carbon substrates) and the availability of electron acceptors (N-oxides). The most important environmental regulators for denitrification are: oxygen > pH > temperature (1974). Mineralisation activity provides substrates and is closely related to moisture/oxygen-temperature conditions (Focht and Verstraete, 1977; Morley and Baggs, 2010; Myrold and Tiedje, 1985b). For instance a high rate of soil organic C content mineralisation favours O_2 consumption. In fertilized soils, C rather than NO_3^- availability limits total denitrification, but NO_3^- has a pronounced effect on the ratio of N_2O/N_2 (Beauchamp et al., 1989; Dendooven and Anderson, 1994; McCarty and Bremner, 1993; Myrold and Tiedje, 1985a, b; Nõmmik, 1956). Many studies have focused on either proximal or distal factors, as described by Groffman (Groffman et al., 1988), but only a few studies so far have tried to link these factors. The C substrate determines the efficiency with which N oxides (NO_3^- , NO_2^-) are reduced (Beauchamp et al., 1989). Denitrifiers are able to compete successfully for C with other heterotrophs (Myrold and Tiedje, 1985b). Thus

specific microbe-substrate relationships exist that may explain the link between decomposition products and microbial populations (1989). However, these relationships are still not well understood. The availability and identity of the C substrates and in particular the ratio between C substrate to e^- -acceptor also governs whether denitrification or DNRA occurs in soils. While the need for C is universally acknowledged there is still a need to identify assays that can predict forms of C substrate utilised by various microbial groups (Rütting et al., 2011).

Successive steps in the reductive denitrification sequence exhibit differing sensitivities to oxygen (Betlach and Tiedje, 1981). Higher N_2O emissions and increasing N_2O/N_2 ratios are observed with increasing aerobicity (Focht, 1974; Payne, 1973). Aerobic and anaerobic microsites, as indicated by different redox potentials, co-exist in soil may support different microbial communities. To advance the mechanistic understanding of microbial N cycling in terrestrial ecosystems there is a need to link microsite and not simply bulk soil conditions to microbial activities.

In natural environments diverse microbial populations are observed (Tiedje, 1988). The greatest spatial aggregation is generally observed in the top soil (Nunan et al., 2002). Spatial distributions may develop to the patchy distribution of organic material (Parkin, 1987) and in response to environmental conditions (Tiedje, 1988) such as aerobic-anaerobic microsites. There is still a need to better understand the microenvironment in where N transformations occur (McLaren, 1970). Microbial processes are affected by substrate availability, thermodynamic regulation and inhibition, pH, and redox potential (Brock, 1967; Dassonville and Renault, 2002; Firestone and Davidson, 1989). Interactions between these factors are only poorly understood. Cavigelli and Robertson (Cavigelli and Robertson, 2000) investigated for instance the effect of pH and oxygen on the N_2O/N_2 ratio in both an arable and a non-disturbed successional field and found that the observed differences were most likely governed by the prevailing microbial community.

New conceptual framework for N dynamics in soil

There is a need for new theoretical and conceptual frameworks to understand how microorganisms influence ecosystem processes (2011). Two aspects need to be taken into account to understand the relationships between environmental regulators and microbial activity. First, there needs to be an acknowledgement that different *microsites* exist in the soil, which to date have been considered as homogenous spaces with respect to environmental regulators. Secondly, there is a requirement to identify the *units* that represent physiologically similar microbial entities that live in mutualistic or antagonistic relationships within these *microsite*.

For instance while anaerobic conditions are required for denitrification to proceed, aerobic denitrification (NO_3^- reduction under microaerophilic conditions) has been observed (Bréal, 1892). The co-respiration probably occurs under conditions when respiratory pathways are rate limited by oxygen and additional NO_3^- reduction would allow faster growth rates (Robertson and Kuenen, 1984, 1990). Furthermore, aerobic denitrification appears to be linked to heterotrophic nitrification, and is possibly a detoxifying mechanism to reduce high NO_2^- concentrations (Robertson and Kuenen, 1990) converted to gaseous N forms such as nitrous oxide (N_2O).

Nitrous oxide is predominantly produced in soils and emitted to our atmosphere. Thus, to understand N_2O production from terrestrial ecosystems it is essential to understand the potential production processes. Apart from nitrifiers and denitrifiers, N_2O is also produced by nitrifiers

which are paradoxically denitrifying via a process called nitrifier-denitrification (Wrage et al., 2001). Nitrifier denitrification appeared to be much less important than classical nitrate-driven denitrification. But Wrage et al. (Kool et al., 2011) showed that this pathway can be a major source for N_2O if conditions for denitrification are not optimal. Thus this pathway should not be ignored as a source of N_2O from soil (Kool et al., 2011; Wrage et al., 2001).

Furthermore chemical transformations may also affect the N cycle transformations and losses. Chemodenitrification may occur in soils, including the van Slyke reaction where organic N together with NO_2^- reacts to N_2 (Tiedje, 1988). However, our understanding of the potential contribution of chemodenitrification to gaseous N losses as nitric oxide (NO) and N_2O is far from complete as demonstrated by recent studies and further studies on chemodenitrification are warranted, especially under high N input agricultural systems (Spott et al., 2011). Besides bacteria, fungi are capable N transformations such as NO_3^- assimilation and denitrification when NH_4^+ is depleted (Laughlin and Stevens, 2002; Zumft, 1997). However, there is a dearth of information on fungal denitrification (Morozkina and Kurakov, 2007).

2. Modelling concepts

Various kinetics expressions have been used to model the dynamics of the various N oxides in the denitrification sequence (Kohl et al., 1976) including zero-order (Focht, 1974) first-order (Bowman and Focht, 1974) or Michaelis-Menten kinetics (1981). Betlach and Tiedje (Betlach and Tiedje, 1981) concluded that kinetic models can be a useful guide to evaluate the physiology of denitrification. Most denitrification models now consider a Michaelis-Menten type formulation for each enzymatic step and typically may consider dual substrate reactions (Betlach and Tiedje, 1981; Bowman and Focht, 1974; Focht, 1974). Simple kinetic expressions are restricted to situations where no competition between individual N oxides takes place. Therefore, models based on competitive kinetics have been proposed that allow a branching of the electron flow from a electron donor towards various N oxides (Almeida et al., 1997; Cho and Mills, 1979; Thomsen et al., 1994). In these models each reduction step is governed by the overall availability of electron donors or denitrification intensity and the availability of N oxides for each reduction step (Dendooven et al., 1994). Furthermore, competition between organisms for NO_3^- (e.g. denitrifier, dissimilatory reduction of NO_3^- to NH_4^+) is predominantly governed by the carbon availability. Thus key for the successful evaluation/prediction of heterotrophic activity in aggregated soil, is a detailed knowledge of the kinetic parameter profiles of the individual microbial groups (Tiedje et al., 1982).

Diffusion and conditions in aggregated soil

Kinetic parameters in denitrification models that are applied to field situations are most likely not representative of the true kinetic reaction at the reaction sites because heterogenic distribution and diffusion of N oxides and electron donors has to be taken into account (Betlach and Tiedje, 1981; Focht, 1974). In aggregated soils it is important to consider diffusion to the centre of aggregates where denitrification predominantly occurs (a kind of “hot spot” for denitrification) (Arah, 1990b). Therefore mechanistic models for denitrification need to include microsite specific conditions and microbial interactions (Arah, 1990b; Myrold and Tiedje, 1985a). In particular the distribution of denitrifiers and their activity should be included across the range of soil aggregates (Miller et al., 2009). In diffusion-reaction models which take into account the aeration status, the diffusion of oxygen (Greenwood and Goodman, 1964; McElwain, 1978) and of the various N species are

required to predict denitrification in aggregated structures (Arah, 1990a; Burford and Stefanson, 1973). These models usually include diffusion-reaction notations with microbial N uptake based on Michaelis-Menten kinetics (Greenwood and Goodman, 1964).

General model development

Models for microbial N dynamics should be embedded in larger models that predict microbial process and their link to nutrient cycling and take into account the high spatial and temporal nature of the processes (Groffman, 1991). Not only a single relationship but the complexity of microbial reactions that reflect the high spatial and temporal variability needs to be considered to adequately connect ecological theory with molecular-microbial composition and function (Groffman, 1991). Thus spatial and temporal explicit relationships between the e.g. denitrifier community and environmental regulators should be taken into account. Furthermore, a bottom-up approach should be considered where spatial and temporal variability of microbial dynamics at the microsite level will be used for instance to predict denitrification at the field and regional scale. Furthermore, as mentioned above, e.g. denitrification models should be embedded in models that simulate the C-N interactions in soil (e.g. DNDC, Li et al., 1992; NCSOIL, Molina et al., 1983; CENTURY, Parton et al., 1987). Currently no model exists that takes into account all these aspects, in particular the high spatial and temporal nature of microbial processes.

References

- Ackert, L. T., Jr 2006. The role of microbes in agriculture: Sergei Vinogradskii's discovery and investigation of chemosynthesis, 1880-1910. *Journal of the History of Biology* 39, 373-406.
- Almeida, J. S., Reis, M. A. M., and Carrondo, M. J. T. 1997. A unifying kinetic model of denitrification. *Journal of Theoretical Biology* 186, 241-249.
- Arah, J., and Smith, K. A. 1989. Steady-state denitrification in aggregated soils: a mathematical model. *Journal of Soil Science* 40, 139-149.
- Arah, J. R. M. 1990a. Diffusion-reaction models of denitrification in soil microsites. *In* "Denitrification in soil and sediment" (N. P. Revsbech and J. Sørensen, eds.), pp. 245-258. Plenum Press, New York.
- Arah, J. R. M. 1990b. Modelling spatial and temporal variability of denitrification. *Biology and Fertility of Soils* 9, 71-77.
- Aulie, R. P. 1970. Boussingault and the nitrogen cycle. *Proceedings of the American Philosophical Society* 114, 435-479.
- Barnard, R., Leadley, P. W., Lensi, R., and Barthes, L. 2005. Plant, soil microbial and soil inorganic nitrogen responses to elevated CO₂: a study in microcosms of *Holcus lanatus*. *Acta Oecologica* 27, 171-178.
- Beauchamp, E. G., Trevors, J. T. and Paul, J. W. 1989. Carbon sources for bacterial denitrification. *Advances in Soil Science* 10, 113-142.
- Betlach, M. R. and Tiedje, J. M. 1981. Kinetic explanation for accumulation of nitrite, nitric oxide, and nitrous oxide during bacterial denitrification. *Applied and Environmental Microbiology* 42, 1074-1084.
- Bowman, R. A. and Focht, D. D. 1974. The influence of glucose and nitrate concentrations upon denitrification rates in sandy soils. *Soil Biology & Biochemistry* 6, 297-301.
- Braker, G., Zhou, J., Wu, L., Devol, A. H. and Tiedje, J. M. 2000. Nitrite reductase genes (*nirK* and *nirS*) as functional markers to investigate diversity of denitrifying bacteria in pacific northwest marine sediment communities. *Applied and Environmental Microbiology* 66, 2096-2104.
- Bréal, E. 1892. De la présence, dans la paille, d'un ferment aérobie, réducteur des nitrates. *Comptes Rendus hebdomadaires des Séances de l'Académie des Sciences (Paris)* 114, 681-684.
- Brock, T. D. 1967. The ecosystem and the steady state. *BioScience* 17, 166-169.
- Burford, J. R. and Bremner, J. M. 1975. Relationships between the denitrification capacities of soils and total, water-soluble and readily decomposable soil organic matter. *Soil Biology & Biochemistry* 7, 389-394.
- Burford, J. R., and Stefanson, R. C. 1973. Measurements of gaseous losses of nitrogen from soils. *Soil Biology & Biochemistry* 5, 133-141.

- Burger, M. and Jackson, L. E. 2004. Plant and microbial use and turnover: rapid conversion of nitrate to ammonium in soil with roots. *Plant and Soil* 266, 289-301.
- Cavigelli, M. A. and Robertson, G. P. 2000. The functional significance of denitrifier community composition in a terrestrial ecosystem. *Ecology* 81, 1402-1414.
- Chalk, P. M. and Smith, C. J. 1983. Chemodenitrification. In "Gaseous loss of nitrogen from plant soil systems" (J. R. Freney and J. R. Simpson, eds.), pp. 65-89. Martinus Nijhoff and Dr W Junk, Dordrecht.
- Cho, C. M., and Mills, J. G. 1979. Kinetic formulation of the denitrification process in soil. *Canadian Journal of Soil Science* 59, 249-257.
- Clément, J.-C., Shrestha, J., Ehrenfeld, J. G., and Jaffé, P. R. 2005. Ammonium oxidation coupled to dissimilatory reduction of iron under anaerobic conditions in wetland soils. *Soil Biology & Biochemistry* 37, 2323-2328.
- Dassonville, F. and Renault, P. 2002. Interactions between microbial processes and geochemical transformations under anaerobic conditions: a review. *Agronomie* 22, 51-68.
- Davidson, E. A. and Seitzinger, S. 2006. The enigma of progress in denitrification research. *Ecological Applications* 16, 2057-2063.
- Dendooven, L., and Anderson, J. M. 1994. Dynamics of reduction enzymes involved in the denitrification process in pasture soil. *Soil Biology & Biochemistry* 26, 1501-1506.
- Dendooven, L., Splatt, P., Anderson, J. M. and Scholefield, D. 1994. Kinetics of the denitrification process in a soil under permanent pasture. *Soil Biology & Biochemistry* 26, 361-370.
- Firestone, M. K. and Davidson, E. A. 1989. Microbiological basis of NO and N₂O production and consumption in soil. In "Exchange of trace gases between terrestrial ecosystems and the atmosphere" (M. O. Andreae and D. S. Schimel, eds.), pp. 7-21. John Wiley & Sons, New York.
- Focht, D. D. 1974. The effect of temperature, pH, and aeration on the production of nitrous oxide and gaseous nitrogen - a zero order kinetic model. *Soil Science* 118, 173-179.
- Focht, D. D. and Verstraete, E. 1977. Biochemical ecology of nitrification and denitrification. In "Advances in Microbial Ecology" (M. Alexander, ed.), Vol. 1, pp. 135-214. Plenum Press, New York.
- Galloway, J. N. and Cowling, E. B. 2002. Reactive nitrogen and the world: 200 years of change. *Ambio* 31, 64-71.
- Greenwood, D. J. and Goodman, D. 1964. Oxygen diffusion and aerobic respiration in soil spheres. *Journal of the Science of Food and Agriculture* 15, 579-588.
- Groffman, P. M. 1991. Ecology of nitrification and denitrification in soil evaluated at scales relevant to atmospheric chemistry. In "Microbial production and consumption of greenhouse gases: methane, nitrogen oxides and halomethanes" (J. E. Rogers and W. B. Whitman, eds.), pp. 201-217. American Society for Microbiology, Washington, D.C.
- Groffman, P. M., Altabet, M. A., Böhlke, J. K., Butterbach-Bahl, K., David, M. B., Firestone, M. K., Giblin, A. E., Kana, T. M., Nielsen, L. P. and Voytek, M. A. 2006. Methods for measuring denitrification diverse approaches to a difficult problem. *Ecological Applications* 16, 2091-2122.
- Groffman, P. M., Tiedje, J. M., Robertson, G. P. and Christensen, S. 1988. Denitrification at different temporal and geographical scales: proximal and distal controls. In "Advances in nitrogen cycling in agricultural ecosystems" (J. R. Wilson, ed.), pp. 174-192. CAB International, Wallingford.
- Hall, E. K., Maixner, F., Franklin, O., Daims, H., Richter, A. and Battin, T. 2011. Linking microbial and ecosystem ecology using ecological stoichiometry: a synthesis of conceptual and empirical approaches. *Ecosystems* 14, 261-273.
- Jones, D. L., Shannon, D., Murphy, D. V. and Farrar, J. 2004. Role of dissolved organic nitrogen (DON) in soil N cycling in grassland soils. *Soil Biology & Biochemistry* 36, 749-756.
- Knops, J. M. H., Bradley, K. L. and Wedin, D. A. 2002. Mechanisms of plant-species impacts on ecosystem nitrogen cycling. *Ecology Letters* 5, 454-466.
- Knowles, R. 1982. Denitrification. *Microbiological Reviews* 46, 43-70.
- Kohl, D. H., Vithayathil, F., Whitlow, P., Shearer, G. and Chien, S. H. 1976. Denitrification kinetics in soil systems: the significance of good fits of data to mathematical forms. *Soil Science Society of America Journal* 40, 249-253.
- Kool, D. M., Dolfing, J., Wrage, N. and van Groenigen, J. W. 2011. Nitrifier denitrification as a distinct and significant source of nitrous oxide from soil. *Soil Biology & Biochemistry* 43, 174-178.
- Laudelout, H., Germain, L., Chabalier, P. F. and Chiang, C. N. 1977. Computer simulation of loss of fertilizer nitrogen through chemical decomposition of nitrite. *Journal of Soil Science* 28, 329-339.
- Laughlin, R. J. and Stevens, R. J. 2002. Evidence for fungal dominance of denitrification and codenitrification in a grassland soil. *Soil Science Society of America Journal* 66, 1540-1548.
- Li, C., Frohling, S. and Frohling, T. A. 1992. A model of nitrous oxide evolution from soil driven by rainfall events: 1. model structure and sensitivity. *Journal of Geophysical Research* 97, 9759-9776.

- Liu, B., Mørkved, P. T., Frostegård, Å. and Bakken, L. R. 2010. Denitrification gene pools, transcription and kinetics of NO, N₂O and N₂ production as affected by soil pH. *FEMS Microbiology Ecology* 72, 407-417.
- Manzoni, S., Jackson, R. B., Trofymow, J. A. and Porporato, A. 2008. The global stoichiometry of litter nitrogen mineralization. *Science* 321, 684-686.
- McCarty, G. W. and Bremner, J. M. 1993. Factors affecting the availability of organic carbon for denitrification of nitrate in subsoils. *Biology and Fertility of Soils* 15, 132-136.
- McElwain, D. L. S. 1978. A re-examination of oxygen diffusion in a spherical cells with Michaelis-Menten oxygen uptake kinetics. *Journal of Theoretical Biology* 71, 255-263.
- McLaren, A. D. 1970. Temporal and vectorial reactions of nitrogen in soil: a review. *Canadian Journal of Soil Science* 50, 97-109.
- Miller, M. N., Zebarth, B. J., Dandie, C. E., Burton, D. L., Goyer, C., and Trevors, J. T. 2009. Denitrifier community dynamics in soil aggregates under permanent grassland and arable cropping systems. *Soil Science Society of America Journal* 73, 1843-1851.
- Molina, J. A. E., Clapp, C. E., Shaffer, M. J., Chichester, F. W. and Larson, W. E. 1983. NCSOIL, A model of nitrogen and carbon transformations in soil: description, calibration, and behavior. *Soil Science Society of America Journal* 47, 85-91.
- Morley, N. and Baggs, E. M. 2010. Carbon and oxygen controls on N₂O and N₂ production during nitrate reduction. *Soil Biology & Biochemistry* 42, 1864-1871.
- Morozkina, E. V. and Kurakov, A. V. 2007. Dissimilatory nitrate reduction in fungi under conditions of hypoxia and anoxia: a review. *Applied Biochemistry and Microbiology* 43, 544-549.
- Myrold, D. D., and Tiedje, J. M. 1985a. Diffusional constraints on denitrification in soil. *Soil Science Society of America Journal* 49, 651-657.
- Myrold, D. D., and Tiedje, J. M. 1985b. Establishment of denitrification capacity in soil: effects of carbon, nitrate and moisture. *Soil Biology & Biochemistry* 17, 819-822.
- Nömmik, H. 1956. Investigations on denitrification in soil. *Acta Agriculturae Scandinavica* 6, 195-228.
- Nunan, N., Wu, K., Young, I. M., Crawford, J. W. and Ritz, K. 2002. In situ spatial patterns of soil bacterial populations, mapped at multiple scales, in an arable land. *Microbial Ecology* 44, 296-305.
- Osler, G. H. R. and Sommerkorn, M. 2007. Toward a complete soil C and N cycle: incorporating the soil fauna. *Ecology* 88, 1611-1621.
- Parkin, T. B. 1987. Soil microsite as a source of denitrification variability. *Soil Science Society of America Journal* 51, 1194-1199.
- Parton, W., Silver, W. L., Burke, I. C., Grassens, L., Harmon, M. E., Currie, W. S., King, J. Y., Adair, E. C., Brandt, L. A., Hart, S. C., and Fasth, B. 2007. Global-scale similarities in nitrogen release patterns during long-term decomposition. *Science* 315, 361-364.
- Parton, W. J., Schimel, D. S., Cole, C. V. and Ojima, D. S. 1987. Analysis of factors controlling soil organic matter levels in great plains grasslands. *Soil Science Society of America Journal* 51, 1173-1179.
- Payne, W. J. 1973. Reduction of nitrogenous oxides by microorganisms. *Bacteriological Reviews* 37, 409-452.
- Philippot, L. 2005. Tracking nitrate reducers and denitrifiers in the environment. *Biochemical Society Transactions* 33, 200-204.
- Philippot, L., Andert, J., Jones, C. M., Bru, D. and Hallin, S. 2011. Importance of denitrifiers lacking the genes encoding the nitrous oxide reductase for N₂O emissions from soil. *Global Change Biology* 17, 1497-1504.
- Philippot, L., Čuhel, J., Saby, P. A., Chèneby, D., Chroňáková, A., Bru, D., Arrouays, D., Martin-Laurent, F. and Šimek, M. 2009. Mapping field-scale spatial patterns of size and activity of the denitrifier community. *Environmental Microbiology* 11, 1518-1526.
- Rastetter, E. B., Ågren, G. I. and Shaver, G. R. 1997. Responses of N-limited ecosystems to increased CO₂: a balanced-nutrition, coupled-element-cycles model. *Ecological Applications* 7, 444-460.
- Robertson, L. A. and Kuenen, J. G. 1984. Aerobic denitrification - old wine in new bottles? *Antonie van Leeuwenhoek* 50, 525-544.
- Robertson, L. A. and Kuenen, J. G. 1990. Physiological and ecological aspects of aerobic denitrification. *In* "Denitrification in soil and sediment" (N. P. Revsbech and J. Sørensen, eds.), pp. 91-104. Plenum Press, New York.
- Rütting, T., Boeckx, P., Müller, C. and Klemmedtsson, L. 2011. Assessment of the importance of dissimilatory nitrate reduction to ammonium for the terrestrial nitrogen cycle. *Biogeosciences* 8, 1779-1791.
- Sanderman, J. and Amundson, R. 2003. Biogeochemistry of decomposition and detrital processing. *In* "Biogeochemistry" (W. H. Schlesinger, ed.), Vol. 8, pp. 350-419. Elsevier, Amsterdam.

- Sexstone, A. J., Revsbech, N. P., Parkin, T. B. and Tiedje, J. M. 1985. Direct Measurement of Oxygen Profiles and Denitrification Rates in Soil Aggregates. *Soil Science Society of America Journal* 49, 645-651.
- Šimek, M. and Cooper, J. E. 2002. The influence of soil pH on denitrification: progress towards the understanding of this interaction over the last 50 years. *European Journal of Soil Science* 53, 345-354.
- Spott, O., Russow, R. and Stange, C. F. 2011. Formation of hybrid N₂O and hybrid N₂ due to codenitrification: First review of a barely considered process of microbially mediated N-nitrosation. *Soil Biology & Biochemistry* 43, 1995-2011.
- Stevens, R. J., Laughlin, R. J., and Malone, J. P. 1998. Soil pH affects the processes reducing nitrate to nitrous oxide and di-nitrogen. *Soil Biology & Biochemistry* 30, 1119-1126.
- Thomsen, J. K., Geest, T., and Cox, R. P. 1994. Mass spectrometer studies of the effect of pH on the accumulation of intermediates in denitrification by *Paracoccus denitrificans*. *Applied and Environmental Microbiology* 60, 536-541.
- Tiedje, J. M. 1988. Ecology of denitrification and dissimilatory nitrate reduction to ammonium. In "Biology of anaerobic microorganisms" (A. J. B. Zehnder, ed.), pp. 179-244. John Wiley & Sons, New York.
- Tiedje, J. M., Sexstone, A. J., Myrold, D. D. and Robinson, J. A. 1982. Denitrification: ecological niches, competition and survival. *Antonie van Leeuwenhoek* 48, 569-583.
- Uchida, Y., Clough, T. J., Kelliher, F. M., Hunt, J. E. and Sherlock, R. R. 2011. Effects of bovine urine, plants and temperature on N₂O and CO₂ emissions from a sub-tropical soil. *Plant and Soil* 345, 171-186.
- van der Ploeg, R. R., Böhm, W. and Kirkham, M. B. 1999. On the origin of the theory of mineral nutrition of plants and the law of the minimum. *Soil Science Society of America Journal* 63, 1055-1062.
- Van Kessel, C., Clough, T. J. and Van Groenigen, J. W. 2009. Dissolved organic nitrogen: an overlooked pathway of nitrogen loss from agricultural systems? *Journal of Environmental Quality* 38, 393-401.
- Wrage, N., Velthof, G. L., van Beusichem, M. L. and Oenema, O. 2001. Role of nitrifier denitrification in the production of nitrous oxide. *Soil Biology & Biochemistry* 33, 1723-1732.
- Zak, D. R., Holmes, W. E., White, D. C., Peacock, A. D. and Tilman, D. 2003. Plant diversity, soil microbial communities, and ecosystem function: are there any links? *Ecology* 84, 2042-2050.
- Zumft, W. G. 1997. Cell biology and molecular basis of denitrification. *Microbiology and Molecular Biology Reviews* 61, 533-616.

Can molecular microbial ecology provide new understanding of soil nitrogen dynamics?

Firestone, M., Blazewicz, S. ^bPetersen, D.G., and ³Placella, S.

^aUniversity of California, Berkeley CA USA

^bAarhus University.

^cMichigan State University

1. Introduction

The past several decades has seen rapid and profound advances in methodology capable of identifying and characterizing at a molecular level the complex communities that mediate nitrogen transformations in soil as well as their genetic capacities to carry out N processes. Molecular approaches to identifying and quantifying the genes that code for enzymes mediating the N cycle have given us a capacity to assess the relationships among genes, environmental controllers, and rates of processes (e.g. Petersen et al., 2012)

Molecular Tools for the Nitrogen Cycle

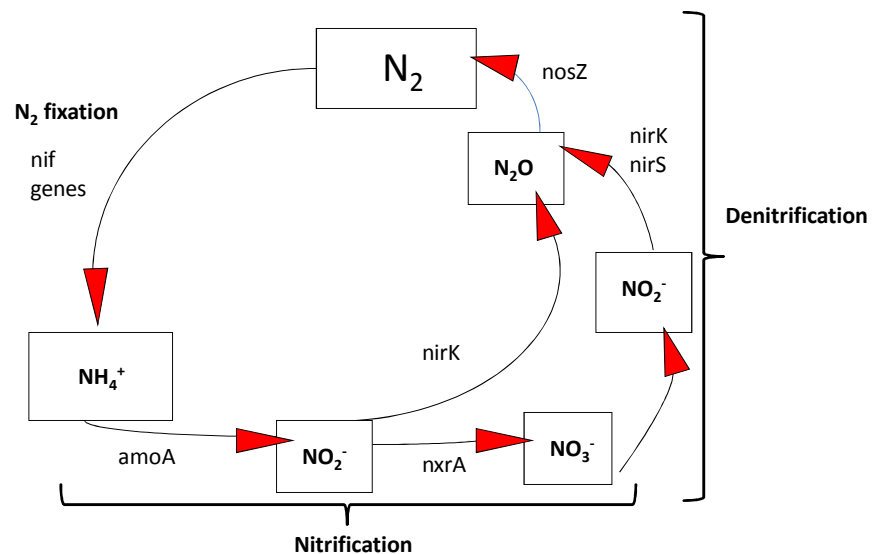

Figure 1. Nitrogen cycle diagram including gene notations for some relevant N transformations

It seems that every two to three years there is renewed promise that “soon” there will be a revolution in our understanding of the microbial bases of nitrogen cycling that will transform the substantial knowledge that has accrued over the past century. Can current and emerging molecular methods further expand our understanding of microbial mediation of soil nitrogen cycling? If so, what information can be provided that is relevant to understanding and predicting

the rates of N-transformations in the field? What molecular information, at what detail and comprehensiveness is necessary or even useful?

2. Linking soil N transformations and microbial ecology

This presentation explores a broad but important question: How changing environmental conditions will alter the characteristics and rates of soil nitrogen transformations. Can molecular characterization of soil microbial communities provide information and understanding useful to this exploration?

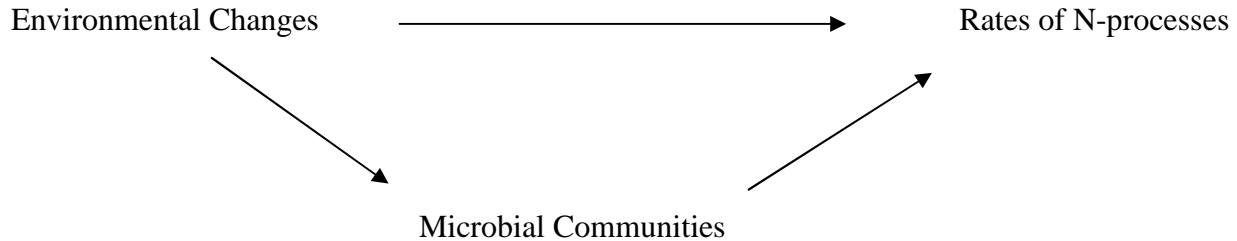

Figure 2. Changes in environmental conditions control process rates directly and through affecting microbial mediation.

Two sets of examples are used to explore if and how information about genes that code for critical N-cycle processes provide information of use. Are there molecular microbial indices that are integrators of past conditions, indices that reflect present potentials, or possibly anticipate future response to changing environments?

The first example will assess the relative values of environmental characteristics and gene abundances for predicting the potential rates of denitrification and nitrification under relatively constant conditions in high latitude ecosystems. Using path analysis to assess the relative predictive value of soil characteristics such as water content, pH, substrate concentration and the values of four potentially relevant genes (coding for nitrite reduction, nitrous oxide reduction, and ammonium oxidation), we find that quantification of gene copies provides the strongest prediction of potential process rates (nitrification and denitrification).

In the second example, molecular analyses provide information about the origin of and mechanisms controlling bursts of N₂O produced during wet up of dry soil. Wet up of dry soils (annual grassland soils) resulting from a California dry Mediterranean-type summer, causes rapid resuscitation of indigenous soil bacteria (Placella et al., 2012). The progression of the genetic control of the enzymes of nitrification and denitrification (at the level of m-RNA) can explain the basis of nitrous oxide production during these episodic events.

Environmental control of each microbial N-process occurs at a number of steps comprising the molecular foundation for the process. In a simplified model (Figure 3), occurrence of a process can be controlled by the environment at the levels of: 1) transcription of genes; 2) translation of

messenger RNA; 3) activity of enzymes. The net effect of the sum of these controls is the actual rate of the process in the field. Considering the points of control, what are the relationships among genes coding for a functional enzyme, transcripts carrying the information necessary for construction of the enzyme (protein), the suite of proteins comprising the functional enzymes, and finally the rate of the process in the field?

From genes to process rates

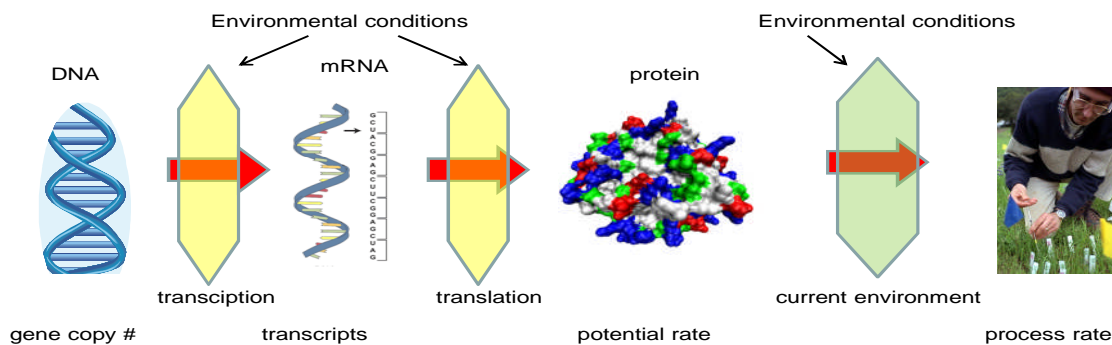

Figure 3. Simplified model of environmental control of processes: from genes to field assays.

The two examples discussed suggest that molecular characterization of the mRNA transcripts coding for nitrification and denitrification genes can provide information predictive of and explaining the origin of pulsed events such as the production of atmospherically reactive trace gases (nitrous oxide and carbon dioxide) during wet up of dry soil. Different molecular indices (gene copy numbers) can provide predictive information about *potential rates* under relatively consistent conditions and when differences are relatively large. While gene copy numbers may predict *potential rates*, they will *not* provide information on actual process rates. Clearly the best way to determine process rates is to measure them.

Gene copy numbers may however reflect history, possibly providing an index of past process occurrence and hence integrating relevant characteristics of the past environment. Gene copy numbers (DNA) should integrate history of activity and environmental control because this characteristic: 1) results from recent usage; 2) reflects historical adaptation of populations within complex microbial assemblages that include more than 10^6 taxa spread across broad phylogenetic lineages; 3) incorporates sequestration of inactive cells and immobilized enzymes by soil matrices. If so, how long a time period may be reflected by gene copy numbers? The historical window of time likely reflects the turnover time of the cells or cell-free enzymes and

the rate of environmental change. While the number of gene copies for N-processing may provide information about past conditions, there has been little work exploring the value of this molecular index for this purpose.

Regulatory networks in bacteria control the response of the organisms to environmental change. Such regulation is achieved by a network of interactions among diverse array of molecules including DNA, RNA, and proteins. Bacterial regulatory networks result from extended evolution and adaptation of bacterial populations comprising complex soil assemblages. The environmental response characteristics coded in these regulatory networks can show anticipation of future environmental changes that have been repeatedly experienced in the past. Thus characteristics of regulatory networks may reflect historical conditions and also anticipate future environmental change. In photosynthetic bacteria, regulatory networks have been used to understand diurnal temporal patterns of photosynthesis. We present data suggesting that aggregate regulatory networks in soil microbial communities anticipate annual patters of precipitation in Mediterranean-type annual grasslands. Nitrifiers present in extremely dry soil carry transcriptional capacity to activate rapidly – arguably in anticipation of rainfall events (Placella and Firestone, in review).

3. Conclusions

Molecular characterization of functional genes and the expression and translation of these genes may provide useful understanding of:

1. How changing environment regulates rates of nitrogen transformations in soil
2. The basis for potential rates of processes under relatively constant environment.

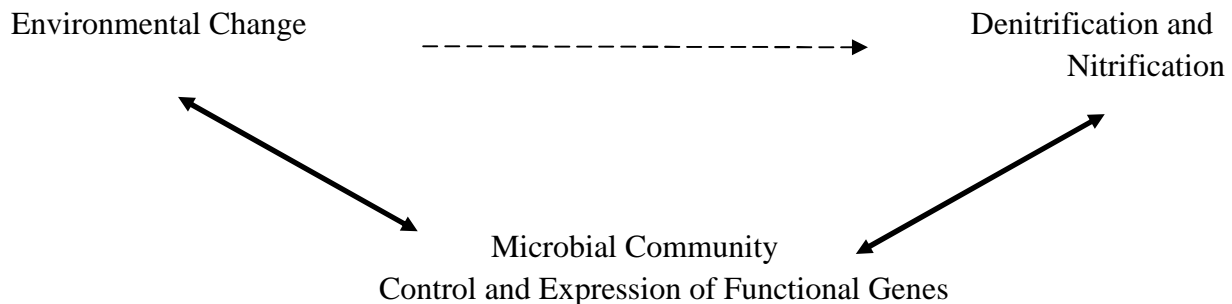

References

- Peterson, D.G., Blazewicz, S., Herman, D.J., Firestone, M., Turetsky, M. and Waldrop, M. 2012. Abundance of microbial genes associated with nitrogen cycling as indices of biogeochemical process rates across a vegetation gradient in Alaska. *Environmental Microbiol* 14, 993-1008
- Placella, S., Brodie, E. and Firestone, M. 2012. Rainfall-Induced CO₂ Pulses Result from Sequential Resuscitation of Phylogenetically Clustered Microbial Groups. *PNAS*. (In Review). Placella, S.A. and M.K. Firestone. Transcriptional Response of Nitrifying Communities to Soil Wet-Up. *Environmental Microbiol*. (In Review)

Tracing of N Transformations in Soil and Gas Phases Using Isotopes and FTIR Spectroscopy

Kira, O, D. Haroush, R. Tzulker, Y. Dubowski, R. Linker, and Avi Shaviv
Division of Environmental, Water and Agricultural Engineering, CEE, Technion-IIT, Haifa

1. Background & Objective

Knowledge regarding the pathways involved in N₂O production is still limited despite efforts to quantify mechanisms and sources of its formation (denitrification, nitrification, nitrifier-denitrification). Even calculations of gross rates of N-mineralization or nitrification are still limited and depend on complex, time consuming and destructive methods. These are essential for developing better management tools and mitigation measures. Techniques for quantitative investigation of N transformations and N₂O source partitioning in soils are based on isotopic enrichment; can be improved by dual-isotope labelling (Baggs, 2008) or alternatively by tracing changes of N₂O isotopomers or isotopologues (e.g. Baggs, 2008; Sutka et al., 2006) in the gas phase. These require the use of IRMS to get quantitative results. Yet, IRMS can not be used on line and demands laborious pre-treatment of soil samples. FTIR spectroscopy with the ability to monitor changes in N-gases (using LP, Long-Path gas cells; e.g. Esler et al, 2000) and in soil N-mineral species (using ATR, Attenuated Total Reflectance, e.g. Linker et al., 2006) offers powerful tools for in-situ investigations; particularly when combining smart labelling of ¹⁵N/¹⁴N and/or ¹⁸O/¹⁶O allowing direct measurements in the soil phase (Du et al., 2009) or changes in N₂O isotopomer concentrations in gas phase (Esler et al., 2000). A new approach used for tracing changes in heterogeneous systems of air pollutants allows *in situ* investigation of changes in gas-liquid-soil phases (Segal-Rosenheimer and Dubowski, 2007). First efforts for developing a novel method based on FTIR spectroscopy for continuous monitoring of isotopic N-species directly in moist soil and gas phase are presented emphasizing their potential to serve as efficient tools to quantify N-dynamics and N₂O source partitioning in complex systems.

2. Materials and Methods

Direct determination of N-isotopic species during soil incubation using FTIR-ATR:

Incubation experiments were performed by adding solutions of ¹⁵NH₄Cl or ¹⁴NH₄Cl to vessels containing Terra Rossa covered with a perforated lid, and incubated at 25⁰C for 8 days. Soil were sampled as follows: 10g were mixed at a ratio of 1:1 with KCl 1N solutions forming a paste that was placed on a Zinc/Se ATR crystal to obtain MIR spectra to determine ¹⁵NH₄, ¹⁴NH₄, ¹⁵NO₃ & ¹⁴NO₃ concentrations using a BRUKER Vector 22 FTIR spectrometer; Afterwards, the pastes were centrifuged, filtered and the clear solutions were placed again on the ATR crystal and MIR spectra taken again. Accordingly, 2 special calibration solutions containing mixtures of all the tested N-species were prepared with (i). soil pastes (1:1 KCl) as background or with (ii) the 1:1 KCl solution after filtration. A PLS algorithm was successfully used for the data processing and calibration of the ¹⁴NH₄Cl set. For the ¹⁵NH₄Cl set a Neural Networks based algorithm was required. Additional samples of ~2 g were extracted at 1:10 ratio of soil:KCl 1N solutions, and used for determining total nitrate + nitrite and ammonium concentrations using an auto analyzer.

Tracing N₂O emission from soils using LP-FTIR gas cells:

Saturated soil samples of a Grumosol were placed at the bottom of an LP-FTIR cell. The LP cell was connected to a FTIR spectrometer, allowing continuous collection of MIR spectra during 22 hrs of soil incubations at different condition (aerobic and non-aerobic conditions, with and without acetylene) and 2 soil thicknesses (~ 2 and ~10 mm). Concentrations were determined using the N₂O peaks at the range of 2200-2250 cm⁻¹.

3. Results and Discussion

Figure 1 shows results obtained for the Terra Rosa soil enriched with $^{15}\text{NH}_4$ (left) or with $^{14}\text{NH}_4$ (right) indicating the contributions of $^{15}\text{NH}_4$ and $^{14}\text{NH}_4$, to the formation of $^{15}\text{NO}_3$ and $^{14}\text{NO}_3$, respectively, and the possibility of simple and non destructive use of FTIR to trace N-dynamics. Gross mineralization rate estimated on the $^{15}\text{NH}_4$ dilution basis was ~ 1.24 mg N/g soil/d, while the net rate estimates based on common measurements were negative.

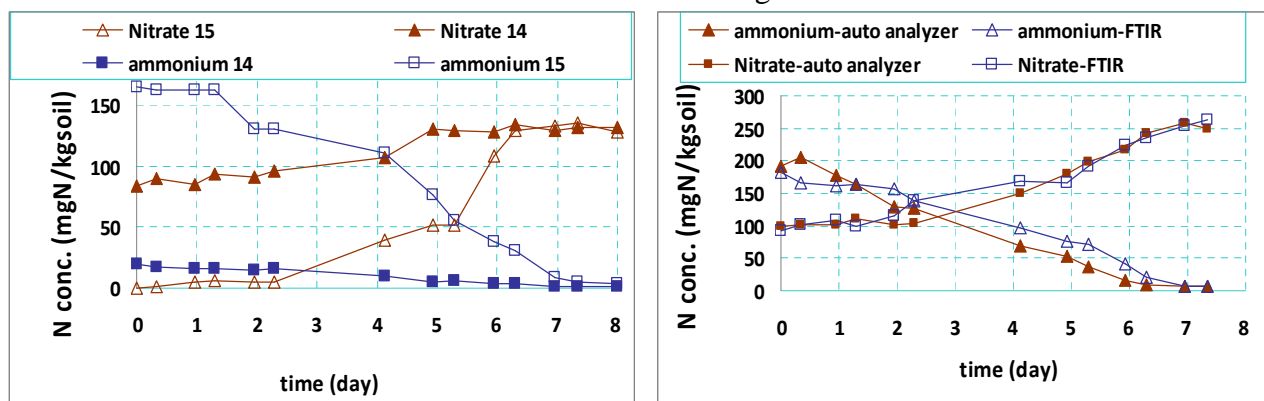

Figure 1. Left: Changes with time of ^{15}N and ^{14}N mineral N-species concentrations obtained for incubation of Terra Rossa amended with $^{15}\text{NH}_4$ using FTIR spectroscopy; Right: Changes with time of ^{14}N mineral N-species concentrations obtained for Terra Rossa incubated with $^{14}\text{NH}_4$ – FTIR results compared to auto-analyzer measurements.

N_2O emissions, measured with the LP-FTIR system, with a Grumosol were significantly affected by aeration and soil thickness. Under aerobic conditions no N_2O was formed, in the 2 mm saturated layer despite the saturation, presumably due to non restricted oxygen supply; yet under non-aerobic conditions $\sim 60\%$ of the initial nitrate was transformed to N_2O , assumingly via denitrification. In the 10 mm saturated layer, exposed to aeration, $\sim 30\%$ of initial mineral-N was lost as N_2O , possibly via nitrification and denitrification. In experiments performed with added acetylene, the losses of N_2O from non-aerobic saturated 2mm soil layers were about ~ 40 to 50% larger than without acetylene addition. The results indicate the possibility of effective and fast/on line tracing of concentration changes of isotopic species of mineral-N in soils with no specific sample treatment/preparation. N_2O emissions can be directly measured in incubated soils allowing measurement of continuous changes in the gas phase. The encouraging results observed with the separate set-ups indicate the potential for the next phase where a combined system consisting of FTIR-ATR and LP-FTIR units will be used for on line measurements of changes in isotopic species both in soil and gas phases. Yet, special emphasis should be put on efforts of increasing accuracy.

References

- Baggs E. M. 2008. A review of stable isotope techniques for N_2O source partitioning in soils: Recent progress, remaining challenges and future considerations. *Rapid Commun. Mass Spectrom* 22, 1664-1672.
- Du, C., Linker, R., Shaviv, A. and Jianmin, Z. 2009. In Situ evaluation of net nitrification rate in Terra Rossa soil using a Fourier transform infrared attenuated total reflection ^{15}N tracing technique. *Appl. Spectrosc.* 63, 1168-1173.
- Esler, M. B., Griffith, D. W. T., Turatti, F., Wilson, S. R., Rahn, T. and Zhang, H. 2000. N_2O concentration and flux measurements and complete isotopic analysis by FTIR spectroscopy. *Chemosphere* 2, 445-454.
- Linker, R., Michal Weiner, Itzhak Shmulevich and Avi Shaviv. 2006. Nitrate determination in soil pastes using FTIR-ATR mid-infrared spectroscopy: Improved accuracy via soil identification. *Biosystems Engineering* 94 (1), 111-118.
- Segal-Rosenheimer, M. and Dubowski, Y. 2007. Heterogeneous ozonolysis of cypermethrin using real-time monitoring FTIR techniques. *J. Phys. Chem. C* 111, 11682-11691.
- Sutka, R. L., Ostrom, N. E., Ostrom, P. H. and Breznak, J. A. 2006. Gandhi, H.; Pitt, A. J.; Li, F. Distinguishing nitrous oxide production from nitrification and denitrification on the basis of isotopomer abundances. *Appl. Environ. Microbiol.* 72, 638-644.

Effects of a nitrification inhibitor on soil nitrogen transformations and N₂/N₂O emissions after application of slurry to Irish grassland soils -- a microcosm study

Ernfors, M.^{a,b}, Brennan, F.^{a,c}, McGeough, K.^d, Müller, C.^e, Laughlin, R.J.^d, Watson, C.J.^d, Griffiths, B.F.^a, Philippot L.^c, Richards, K.G.^a

^aTeagasc, Johnstown Castle, Environmental Research Centre, Co Wexford, Rep. of Ireland

^bSwedish University of Agricultural sciences, Department of Agrosystems, Box 104, SE-230 53 Alnarp, Sweden

^cINRA, UMR 1347, Agroecology, 17 rue Sully BP 86510, 21065 Dijon, Cedex, France

^dAgri-Food and Biosciences Institute, Newforge Lane, Belfast, BT9 5PX, Northern Ireland

^eDepartment of Plant Ecology, Justus-Liebig University Giessen, Heinrich-Buff-Ring 26, 35392 Giessen, Germany

1. Background & Objectives

The nitrification inhibitor dicyandiamide (DCD) is used for the purpose of increasing nitrogen efficiency in agriculture. It slows down the conversion of ammonium (NH₄⁺) to nitrate (NO₃⁻), which can reduce NO₃⁻ leaching and nitrous oxide (N₂O) emissions. However, a detailed understanding of how DCD affects the complex nitrogen (N) transformations taking place in the soil after addition of slurry is lacking. The impact on the N-cycling microbial communities remains unclear and the extent to which N₂O and N₂ emissions are affected by DCD is not well known. The main objectives of this study were to determine the effects of DCD, after cattle slurry application, on (1) net and gross N transformations, (2) emissions of N₂O and N₂, and (3) the abundance of functional genes involved in nitrification and denitrification.

2. Materials & Methods

A microcosm study was carried out in the laboratory, using three contrasting Irish grassland soils. Cattle slurry (6.7 tonnes ha⁻¹), with or without amendment with DCD (4.4 kg ha⁻¹) was applied on top of sieved soil samples that were repacked to a bulk density of 0.88 g cm⁻³. Either the NH₄⁺ or the NO₃⁻ pool was isotopically labelled, in parallel ¹⁵N treatments, for the quantification of gross N transformation rates. The amounts of water in the treatments were adjusted to achieve a soil water-filled pore space of 65 % after application and the samples were incubated at 15 °C. Gas sampling and/or soil extraction was done at 0 h, 2 h, 3.5 h, 5.5 h, 7.5 h, 2 d, 6 d, 10 d, 15 d and 20 d after amendment. Gross N transformations were obtained using a ¹⁵N-tracing model (Müller et al., 2007). PLFA analysis was used to provide a fingerprint of the viable microbial community structure, and abundance of ammonia oxidizers and denitrifiers were monitored by targeting functional genes, using qPCR.

3. Results & Discussion

Net nitrification, over 20 days, decreased by 89 % (P < 0.05) when cattle slurry was amended with DCD before application to soil (Figure 1). The inhibition of nitrification by DCD also significantly (P < 0.05) reduced cumulative emissions of N₂O and N₂, by 27 and 52 %, respectively (Figure 2). The N₂O/(N₂O+N₂) ratio was not affected. Further results on gross N transformation rates and effects of DCD on the N-cycling microbial communities will be presented.

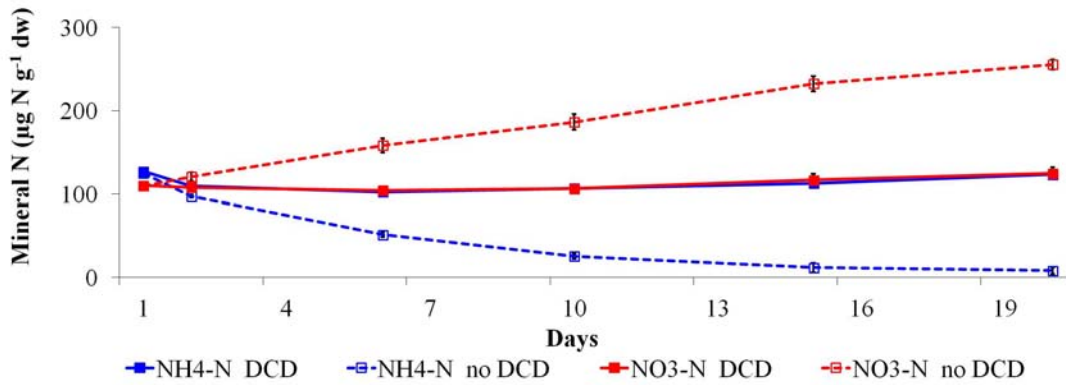

Figure 1. Mean NH₄⁺ and NO₃⁻ concentrations in grassland soil, over 20 days after application of cattle slurry, with and without a DCD amendment. The graph shows averages from three sites in Ireland.

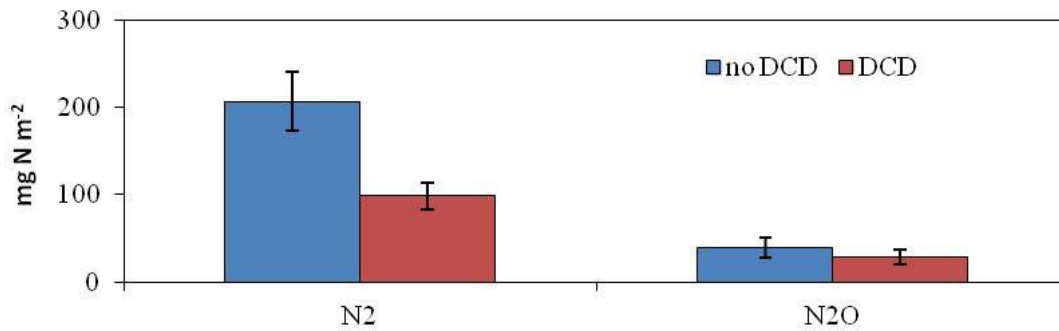

Figure 2. Cumulative N₂O and N₂ emissions, over 20 days after application of cattle slurry, with and without a DCD amendment. The graph shows averages from three grassland sites in Ireland.

4. Conclusion

In this laboratory study, DCD was shown to be an efficient inhibitor of nitrification when used as an amendment to cattle slurry applied to grassland soil. The decrease in nitrification also led to significant decreases in N₂O and N₂ emissions. Further results on gross N transformation rates and effects of DCD on the N-cycling microbial communities will be presented.

References

Müller C., Rütting T., Kattge J., Laughlin R.J. and Stevens R.J. 2007. Estimation of parameters in complex ¹⁵N tracing models by Monte Carlo sampling. *Soil Biology & Biochemistry* 39, 715-726.

The fate of urine nitrogen with use of a nitrification inhibitor

Selbie, D.^{a,b}, Cameron, K.C.^b, Di, H.J.^b, Moir, J.L.^b, Lanigan, G.^a, Laughlin R.J.^c, Richards, K.G.^a

^aTeagasc, Johnstown Castle, Environmental Research Centre, Co. Wexford, Ireland

^bSoil & Physical Sciences Dept., Lincoln University, Canterbury, New Zealand

^cAgri-Food and Biosciences Institute, Newforge Lane, Belfast, BT9 5PX, Northern Ireland

1. Background & Objectives

Pasture-grazed ruminants in Ireland contribute a significant proportion of nitrogen (N) loss to the environment through excreta deposition. Feed N utilisation by the ruminant animal is low with 60-90% of ingested N returned to the soil/pasture system in the excreta, particularly in the urine (Haynes and Williams, 1993). The urine N loading rate in a single cattle urine patch is approximately 1000 kg N ha⁻¹ (Haynes and Williams, 1993). N balance studies have estimated the fate of urine N on a range of soils (Clough et al., 1998). Application of dicyandiamide (DCD) nitrification inhibitor has consistently reduced N leaching and N₂O emissions from urine patches (Di and Cameron, 2007; de Klein et al., 2011), but produced variable pasture N responses (Di and Cameron, 2007; Zaman and Blennerhassett, 2010). A ¹⁵N balance study was conducted on grassland lysimeters in Ireland to investigate the fate of urine N with and without the application of DCD nitrification inhibitor.

2. Materials & Methods

Urine labelled with the ¹⁵N isotope was applied to soil monolith lysimeters at a rate of 1000 kg N ha⁻¹ with and without DCD in late autumn. DCD was applied in solution form at 30 kg DCD ha⁻¹ in two split applications, the first following urine application in late autumn and the second in late winter. Drainage water was analysed using standard methods for nitrate (NO₃⁻), ammonium (NH₄⁺) and total N. Nitrous oxide (N₂O) and di-nitrogen (N₂) were sampled from static chambers (Hutchinson and Mosier, 1981) and quantified by gas chromatography for N₂O and by isotope ratio mass spectrometry (IRMS) for N₂. Dissolved N₂O in drainage water was extracted using helium gas and analysed for N₂O above. Pasture was harvested monthly and analysed for total N content using standard methods. Soil cores were extracted from lysimeters at the end of the experiment from varying depths and analysed for NO₃⁻ and NH₄⁺ and total N. ¹⁵N enrichment of water and soil extracts was estimated using a diffusion method (Chen and Dittert, 2008) and together with pasture and gas, analysed using IRMS.

3. Results & Discussion

Mass N recoveries from water, gas and pasture fractions are shown in Table 1. In terms of mass recovery, pasture N uptake was the largest sink (44.5%) under a 1000 kg N ha⁻¹ urine patch without DCD, followed by N leaching (24.3%) and then by gaseous emissions (1.9%). The incomplete mass balance in the U1000 treatment shows that 29.3% of urine N was unaccounted for, and may have been immobilized in the soil. Application of DCD appeared to reduce total N in water, gas and pasture fractions, giving rise to an unaccounted for N fraction of 35.2% of N applied, which was larger than 29.3% where no DCD was applied.

Table 1. Mass balance of urine applied at 1000 kg N ha⁻¹ with and without DCD nitrification inhibitor

MASS BALANCE			
Fraction	N form	N loading (kg N ha ⁻¹)	
		U1000	U1000+DCD
WATER	Nitrate	178.23	108.74
	Ammonium	18.16	31.54
	Nitrite	3.37	2.96
	Dissolved organic N	43.53	54.19
Sub total		243.29	197.43
GAS	Surface-emitted nitrous oxide	7.13	5.53
	Dissolved nitrous oxide	0.065	0.083
	Surface-emitted di-nitrogen	11.35	6.84
Sub total		18.55	12.45
PASTURE			
Sub total		445.03	438.30
TOTAL N RECOVERED^a		706.87	648.19
N UNACCOUNTED FOR^b		293.13	351.81

^aControl (0 N) subtracted from treatments within fractions

^bUrine N applied (1000 kg N ha⁻¹) – Total N recovered = N unaccounted for

4. Conclusions

The urine N mass balance showed that pasture N uptake accounted for the largest proportion of the urine N applied, followed by N leaching and then gaseous emissions. Application of DCD reduced N found in water, gas and pasture, leading to a greater fraction of N unaccounted for. A complete ¹⁵N balance will be presented at the conference which includes the soil fraction as well as water, gas and pasture fractions.

References

- Chen, R.R. and Dittert, K. 2008. Diffusion technique for N-15 and inorganic N analysis of low-N aqueous solutions and Kjeldahl digests. *Rapid Communications in Mass Spectrometry* 22, 1727-1734.
- Clough, T.J., Ledgard, S.F., Sprosen, M.S. and Kear, M.J. 1998. Fate of N-15 labelled urine on four soil types. *Plant and Soil* 199, 195-203.
- de Klein, C.A.M., Cameron, K.C., Di, H.J., Rys, G., Monaghan, R.M. and Sherlock, R.R. 2011. Repeated annual use of the nitrification inhibitor dicyandiamide (DCD) does not alter its effectiveness in reducing N₂O emissions from cow urine. *Animal Feed Science and Technology* 166-167, 480-491.
- Di, H.J. and Cameron, K.C. 2007. Nitrate leaching losses and pasture yields as affected by different rates of animal urine nitrogen returns and application of a nitrification inhibitor - a lysimeter study. *Nutrient Cycling in Agroecosystems* 79, 281-290.
- Haynes, R.J. and Williams, P.H. 1993. Nutrient cycling and soil fertility in the grazed pasture ecosystem. *Advances in Agronomy* 46, 119-199.
- Hutchinson, G.L. and Mosier, A.R. 1981. Improved soil cover method for field measurement of nitrous-oxide fluxes. *Soil Science Society of America Journal* 45, 311-316.
- Zaman, M. and Blennerhassett, J.D. 2010. Effects of the different rates of urease and nitrification inhibitors on gaseous emissions of ammonia and nitrous oxide, nitrate leaching and pasture production from urine patches in an intensive grazed pasture system. *Agriculture Ecosystems & Environment* 136, 236-246.

Search for the missing N: Excess N₂ in groundwater and streams

Fox, R.J.^a, Fisher, T.R.^a, Gustafson, A.B.^a, Jordan, T.E.^b, Knee, K.^b, Brenner, D.^b

^a Horn Point Laboratory, Center for Environmental Science, University of Maryland, Cambridge MD 21613, USA

^b Smithsonian Environmental Research Center, PO Box 28, Edgewater MD 21037, USA

1. Background & Objectives

The majority of known nitrogen inputs to watersheds cannot be accounted for by stream discharge. Howarth et al. (1996), Jordan and Weller (1996), Boyer et al. (2002), and Schaefer and Alber (2007) have shown that export of N from North American rivers draining into the Atlantic accounts for only 9-25% of the net anthropogenic N inputs (NANI) to their watersheds; the missing N (75-91% of NANI) must be either (1) stored in soils or biomass or (2) lost to the atmosphere via denitrification or other biological N₂ and N₂O production (Van Breeman et al., 2002). We hypothesize that the majority of the missing N is converted to biological N₂ within the watershed. Here we present evidence for the biological production of N₂ and N₂O in soils of a Mid-Atlantic coastal plain watershed in North America.

2. Materials & Methods

We measured excess N₂ and N₂O in groundwater, streams, and vadose zone gas. Excess N₂ is defined as measured concentrations exceeding those expected from air equilibrium based on temperature (streams) or Ar concentrations (vadose gas, groundwater). Gas concentrations in water were measured by membrane inlet mass spectrometry (MIMS; O₂, N₂, Ar; Kana et al. 1994) or by gas chromatography (N₂O). In vadose zone gas, we measured N₂O as in water, and we used a new method for N₂/Ar using a capillary inlet mass spectrometer (CIMS, Fox, 2011) with a precision similar to MIMS (0.05%).

3. Results & Discussion

Excess N₂ and N₂O were common in all three environments. Groundwater under well-drained agricultural fields has high O₂ (50-80% saturation), high NO₃⁻ (500-1000 μM), little

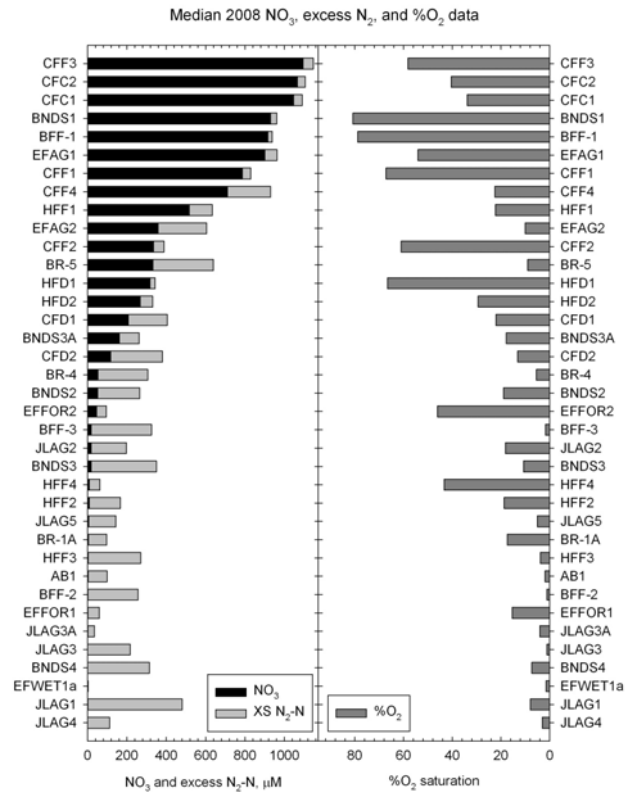

Figure 1. Spatial variations in median NO₃⁻, excess N₂, and O₂ in groundwater in the Choptank Basin. The Y axes are individual piezometers, the upper ¼ are in agricultural fields while the lower ¼ are in wetlands adjacent or within agricultural fields.

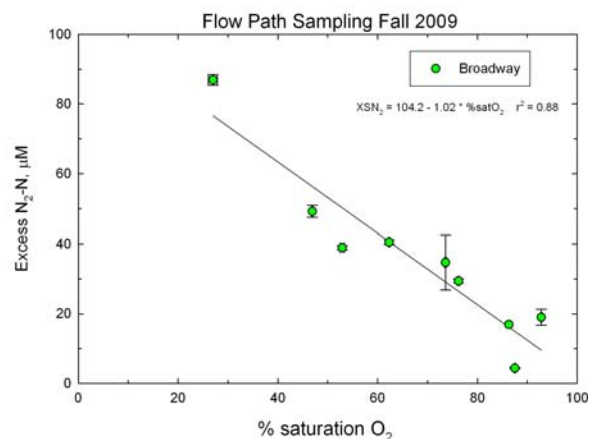

Figure 2. % O₂ saturation was inversely related to excess N₂- N in flowing stream water in fall 2009.

excess N_2-N (20-50 μM , e.g, CFF3, CFC2, CFC1 in Fig. 1), and low to moderate N_2O-N (0.02-4.8 μM). In contrast, under wetlands with hydric soils near agricultural fields, there are low concentrations of O_2 (0-50% saturation), low NO_3^- (0-100 μM), high excess N_2-N (50-500 μM , e.g, EFWET1A, JLAG4, JLAG3 & 3A, Fig. 1), and variable N_2O-N (0.02 to 75 μM). In flowing stream waters excess N_2-N had moderate concentrations (0-100 μM) which were inversely related to O_2 (Figure 2). In the vadose zone direct estimates of excess N_2 were made but were variable due to the assumption of constant atmospheric Ar for calculations (Figure 3). Higher partial pressures of N_2 were always present in groundwater, and decreased towards the soil surface (Figure 3). The CIMS method requires further development in order to make more accurate estimates of excess N_2 concentrations within vadose zone gas, but currently we are able to measure small significant increases and decreases in N_2/Ar .

4. Conclusion

The measured concentrations of N_2 in groundwater, stream water, and the vadose zone show strong evidence that denitrification or N_2 production through other processes is the source for the majority of the missing N within this watershed. In future research we hope to improve our estimates of N_2 and N_2O to the atmosphere in order to test the hypothesis that the missing N is converted biologically into N_2 and N_2O , which then evades into the atmosphere through stream and soil surfaces. We also hope to integrate these measurements spatially to estimate fluxes of biological N_2 and N_2O to the atmosphere.

References

- Boyer, E.W., C.L. Goodale, N.A. Jaworki, R.W. Howarth. 2002. Anthropogenic nitrogen sources and relationships to riverine nitrogen export in the northeastern U.S.A. *Biogeochemistry*. 57/58, 137-169.
- Fox, R. J. 2011. Dynamics of metabolic gases in groundwater and the vadose zone of soils on Delmarva. PhD thesis, University of Maryland, 318 pages.
- Howarth, R.W., G. Billen, D. Swaney, A. Townsend, N. Jaworski, K. Lajtha, J.A. Downing, R. Elmgren, N. Caraco, T. Jordan, F. Berendse, J. Freney, V. Kudeyardov, P. Murdoch, and Z. Zhao-Liang. 1996. Regional nitrogen budgets and riverine N & P fluxes for the drainages to the North Atlantic Ocean: Natural and human influences. *Biogeochemistry*. 35(1), 75-139.
- Jordan, T.E., and D. W. Weller. 1996. Human contributions to terrestrial nitrogen flux. *BioScience*. 46(9):655-664.
- Kana, T.M., C. Darkangelo, M.D. Hunt, J.B. Oldham, G.E. Bennett, and J.C. Cornwell. 1994. Membrane inlet mass spectrometer for rapid high-precision determination of N_2 , O_2 and Ar in environmental water samples. *Analytical Chemistry*. 66(23), 4166-4170.
- Schaefer, S. C. and M. Alber. 2007. Temperature controls a latitudinal gradient in the proportion of watershed nitrogen exported to coastal ecosystems. *Biogeochemistry*. 85, 333-346.
- Van Breemen, N., E. W. Boyer, C. L. Goodale, N. A. Jaworski, K. Paustian, S. P. Seitzinger, K. Lajtha, B. Mayer, D. Van Dam, R. W. Howarth, K. J. Nadelhoffer, M. Eve, and G. Billen. 2002. Where did all the nitrogen go? Fate of nitrogen inputs to large watersheds in the northeastern U.S.A. *Biogeochemistry*. 57/58, 267-293.

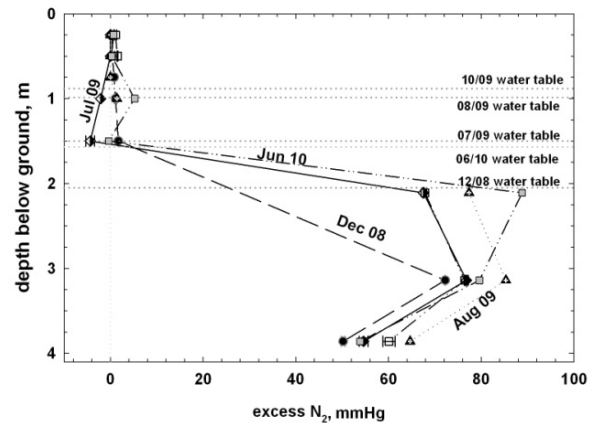

Figure 3. Excess N_2 profiles measured in a riparian area next to an agricultural field using the CIMS (vadose zone) and MIMS (groundwater) methods. Concentrations are expressed in partial pressure units to compare the dissolved and gas phase concentrations. The lower three points are within groundwater, and the upper points are within the vadose zone. The depth to the water table varies significantly and the water table depth for each sampling time is denoted as a labelled dotted line.

Characterising dissolved organic matter flux in UK freshwaters: Sources, Transport and Delivery

Yates, C.A. Johnes, P. J. Spencer, R. G. M.

Department of Geography and Environmental Science, University of Reading, Reading, UK

1. Background and Objectives

The flux of nutrients to water bodies is increasing world wide as a function of climatic warming, the intensification of agriculture, car use and fossil fuel combustion in both developing and developed countries. Such nutrient enrichment (particularly carbon and nitrogen) is leading to substantial environmental degradation including: changes in species composition within freshwater and marine plant and animal communities, excessive growth of filamentous/ blue-green alga and the formation of carcinogenic N-nitrosodimethylamine and trihalomethane as disinfection byproducts during drinking water treatment. Current research and policy development surrounding catchment scale macronutrient balances has focussed mainly on inorganic nutrient concentration data. Much of our current understanding of biogeochemical cycling has been gained through research conducted within developed countries whose river systems have suffered high anthropogenic alteration such as land use change and river channel engineering (Caraco and Cole, 1999; Vega et al., 1998). As a result it has long since been assumed that organic nutrient fractions are relatively recalcitrant when compared to a dominance of labile inorganic fractions. Recent research has shown that organic nutrient fractions are important secondary and sometimes even dominant constituents of the total nutrient load transported to and within river systems with concentrations of dissolved organic nitrogen in many freshwater systems being recorded as much higher than their dissolved inorganic counterparts (Perakis and Hedin, 2002; Durand, Breur, Johnes et al., 2011). If these changes are to be brought under control a detailed understanding of the nature of nutrient delivery to waters from their catchments is required. The main aim of this study is to determine if clear diurnal patterns in nitrogen, phosphorus and carbon fraction concentrations and dissolved organic matter occur instream while using advances in optical characterisation methods determine the specific spatial origins and potential reactivity of both allochthonous and autochthonous organic material.

2. Materials and Methods

Two sub catchments within the Hampshire Avon basin (southern England) were selected for study due to their wide variety of both diffuse and point source nutrient inputs (River Wylfe and Millersford Brook). Daily samples were collected from six stations located across both study catchments and were analysed for: Inorganic and N and P fraction determination using segmented flow colourimetry along with total, particulate and dissolved fraction determination using persulphate oxidation and non purgeable organic carbon concentration. Weekly samples were also collected from these sites plus 12 spatially important locations to allow analysis of samples for determinands which are unstable over periods of more than 24 hours from collection. This included the determination of soluble reactive phosphorus. Analysis was also conducted using novel optical characterisation techniques such as excitation emission fluorescence spectroscopy, which allow identification of the dominant groups which constitute the dissolved organic component, and distinction between the more labile low molecular weight material (amino acids, proteins) which are directly available for plant and algal uptake, and the higher molecular weight components (for example, human and fulvic acids) which are less labile, though an important substrate for microbial decomposition, and lend much to the generation of colour in natural and potable waters.

3. Results and discussion

Current results demonstrate further the relative importance of organic nutrient fractions finding that in areas not under anthropogenic influence organic nitrogen dominates the nutrient pool. In anthropogenically altered systems nitrate was found to be the dominant form of nitrogen present (Figure 1). Organic macronutrient fractions were found to be elevated with concentrations varying both over time and as a function of their source areas. Results demonstrate source to be a key factor in determining organic matter composition and potential reactivity with features such as; sewage treatment works, poor agricultural practises and an abundance of septic tanks found to be locally important macronutrient source areas. Within the chalk dominated Wylde catchment organic nitrogen concentrations were found to be elevated in relation to non purgeable organic carbon concentrations, generating a very low C:N ratio, suggesting compounds such as Urea to be important in optically clear low organic carbon systems dominated by anthropogenic inputs. This contrasts markedly with the findings for the Millersford Brook, which drains a peatland catchment in the New Forest, where higher molecular weight compounds dominated the dissolved organic fraction, contributing to high water colour in the stream, and the carbon to nitrogen ratio approximates to rates reported for other peatland systems in the UK and internationally.

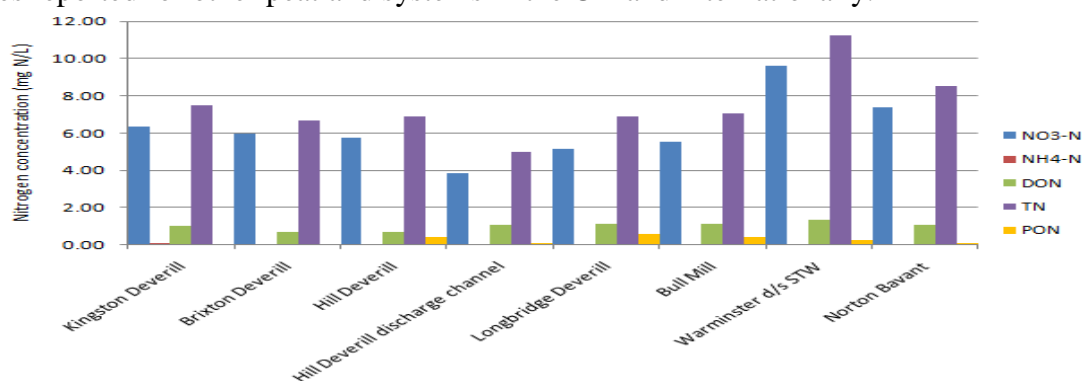

Figure 1. Nitrogen species concentration in the River Wylde

4. Conclusions

The dissolved organic fraction of macronutrient flux varies widely in character, depending on the distribution of contributing source areas in the catchment. In low intensity agricultural catchments dominated by peaty soils, high C:N ratios and a high proportion of high molecular weight components dominate the DOM signal, and DON and DOP are the dominant fractions of the TN and TP load, respectively. In more intensive agricultural systems, with septic tanks serving the rural population, and with predominantly mineral soils in the catchment, DOM contributes a smaller proportion of the TN and TP load, and is dominated by labile, low molecular weight compounds which contribute little to water colour, and generate a relatively low C:N ratio. These findings have implications, both for the ecosystem functional role of DOM in contrasting system types, and for the potential for carcinogenic carbonaceous and nitrogenous disinfection byproduct formation in potable waters abstracted from different water supply intake waters.

References

- Caraco, N.F. and Cole, J.J. 1999. Human impact on nitrate export: An analysis using major world rivers. *Ambio* 28, 167-170.
- Durand, P., Breur, L, Johnes, P.J. et al .2011. Nitrogen Cycling in Aquatic Ecosystems. Ch. 7, European N Assessment, Cambridge University Press.
- Perakis, S.S. and Hedin, L.O. 2002. Nitrogen loss from unpolluted South American forests mainly via dissolved organic compounds (vol 415, pg 416, 2002). *Nature* 418, 665-665.
- Vega, M., Pardo, R., Barrado, E. and Deban, L. 1998. Assessment of seasonal and polluting effects on the quality of river water by exploratory data analysis. *Water Research* 32, 3581-3592.

Investigating the efficacy of soil nitrogen tests to predict soil nitrogen supply across a range of Irish soil types under controlled environmental conditions.

McDonald, N.T.^{a,b}, Watson, C.J.^{cb}, Laughlin, R.J.^c, Lalor, S.T.J.^a, Hoekstra, N.J.^a, Wall, D.P.^a

^aTeagasc, Crops Environment and Land Use Programme, Johnstown Castle, Wexford, Rep. of Ireland.

^bSchool of Biological Sciences, Queen's University Belfast, Belfast, N. Ireland

^cAgri-Food and Biosciences Institute, Newforge Lane, Belfast, N. Ireland

1. Background & Objectives

Nitrogen (N) fertiliser usage on Irish farms is constrained under the European Union (EU) Nitrates Directive (S.I.610, 2010) which is part of the larger EU Water Framework Directive aimed at improving water quality. These constraints and increasing fertiliser prices at farm level coupled with concerns over food security and climate change at international level have placed N use efficiency high up the agri-environmental agenda. In order to maximise the recovery and yield potential derived from N fertiliser, these inputs must be balanced with mineralised N (N_o) from soil reserves. The potential N_o may vary considerably between different soil types, and in Ireland N_o recovery over a range of grassland soils was shown to range from 74 to 212 kg N ha⁻¹ yr⁻¹ (Humphreys, 2007). However, the variability in soil N supply between soils is not reflected in current N recommendations in Ireland and in many fields N fertilisers are either under- or over-supplied compared to requirements for crop growth. The objective of this study was to evaluate soil N tests for predicting soil N supply, grass DM yield and grass N uptake for a range of Irish soil types. This research aims to develop a soil N testing system for Ireland, as a basis for new soil specific N fertiliser advice to help farmers achieve grass production targets while conserving N fertiliser resources, and minimising N losses to the environment.

2. Materials & Methods

A soil microcosm experiment was established to compare grass growth across 28 different soil types. Soils were collected throughout Ireland to a depth of 10cm, potted in 11.3 L pots, optimised with key macronutrients (i.e. P, K & S) and seeded with ryegrass (*Lolium perenne* L.). No N fertiliser was added to these soils over the duration of the experiment. Four replications of each soil type were placed into a controlled environment facility in randomised blocks (where shelf position was the blocking factor). The temperature was fixed at 15°C, relative humidity at 80%, soil water maintained at 65% field capacity, and day-length at 16 hours light per day. Four grass harvests from each pot were taken at five week growth intervals and the grass DM yield, N content and N uptake were determined. The soils were also sampled to a depth of 10cm at each harvest time and analysed within 24 hours for mineral N (Total Oxidized N (TON= NO₃-N + NO₂-N) & NH₄⁺-N) using 2M KCl extraction. The remainder of the soil (approx 40g) was dried at 40°C and sieved to 2mm. The N_o potential was analysed using a standard seven-day anaerobic incubation method (AI-7) (Waring and Bremner, 1964) and the Illinois soil N test (ISNT) (Khan et al., 2001). Soils were analysed for a range of physical, chemical and biological properties, e.g. Total C and N, texture, pH and soil organic matter levels. Regression and stepwise regression analysis was performed on these data in SAS. JMP. version 9, to model the relationships between AI-7 and ISNT, and between mineral N, ISNT and grass DM yield and grass N uptake across the 28 soil types.

3. Results & Discussion

There was a large range in N_o potential (73 to 396 mg NH₄⁺-N kg⁻¹) over the 28 different soil types in this study as measured by AI-7. This shows that some soil types have the capacity to supply more of the grass N requirement than others. Therefore less N fertiliser may be required to reach

optimum grass growth on these soils. Illinois soil N test (ISNT) values were correlated with AI-7 values across all soils ($r^2 = 0.68$). This result supports previous laboratory studies where six rapid chemical N tests were compared to the time consuming AI-7 method across 35 similar soil types. Here the ISNT was found to be the best rapid soil test for predicting of N_o (McDonald et al., 2011). However, ISNT does not measure TON and by itself was a poor predictor of grass yield across all 28 soil types (Figure 1). Thirteen out of 28 soils had high residual TON levels ($>6 \text{ mg kg}^{-1}$) after harvest (Figure 2). These soils produced higher grass DM yields and grass N uptake compared to the soils with low residual N levels. Total Oxidised N was a poor predictor of grass yield for sites with low residual N reserves, as these sites relied on the supply of N through N_o . However, when both ISNT and TON were combined to predict grass DM yield and grass N uptake across these soil types, the r^2 for these prediction models were 0.78 and 0.87 respectively.

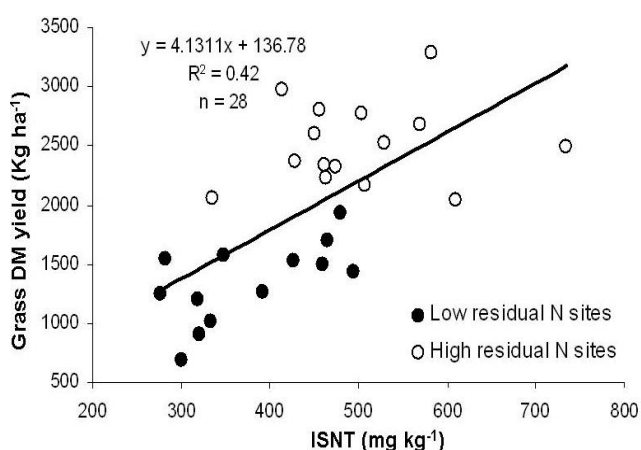

Figure 1. Illinois soil N test (ISNT) versus grass DM yield for 28 soil types.

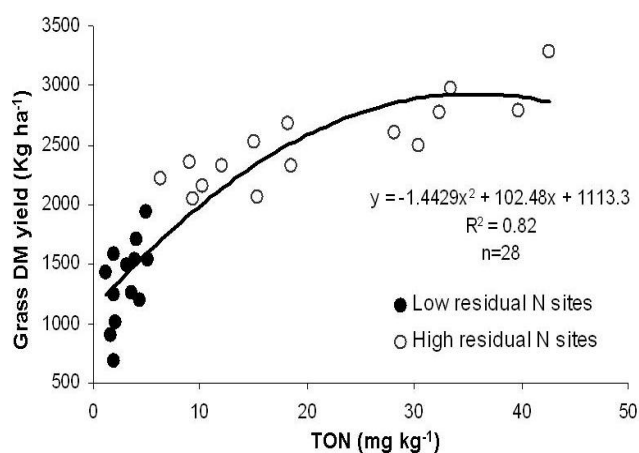

Figure 2. Residual Total Oxidised N (TON) versus grass DM yield for 28 soil types.

4. Conclusion

Irish soil types have the capacity to supply high levels of N through N_o . This shows that there is scope to reduce N fertiliser application rates on some soils without compromising grass DM yields. The ISNT was correlated with AI-7 and is suitable for routine soil analysis to predict N_o . Where high levels of residual TON was present in some soils, this contributed to higher grass DM yield and grass N uptake above what would have been achieved from N_o alone. When combined in a model, ISNT and TON were able to predict both grass DM yield and grass N uptake with a high degree of accuracy. This work shows the potential to better manage N fertiliser inputs based on soil N supply potential in order to increase N use efficiency.

References

- Humphreys, J. 2007. Cutting back on fertilizer in 2007. In: The Fertilizer Association of Ireland 2007-2008, pp. 2-35.
- Khan, S.A., Mulvaney, R.L. and Hoef, R.G. 2001. A simple soil test for detecting sites that are nonresponsive to nitrogen fertilization. *Soil Science Society of America Journal* 65, 1751-1760.
- McDonald, N.T., Watson, C.J., Laughlin, R.J. Lalor, S.T.J., Hoekstra, N.J. and Wall, D.P. 2011. Accounting for the potential supply of nitrogen from Irish grassland soils. The British Grassland Society 10th Research Conference, Hillsborough, Belfast.
- Waring, S.A. and Bremner, J.M. 1964. Ammonium production in soil under waterlogged conditions as an index of nitrogen availability. *Nature (London)* 201, 951.

1 SESSION

Advances in Understanding Nflows and Transformations

Poster Presentations

A new approach for measuring ammonia volatilization in the field: First results of the French research project “VOLAT’NH3”

Cohan J.P.^a, Charpiot A.^b, Morvan T.^c, Eveillard P.^d, Trochard R.^a, Champolivier L.^e, De Chezelles E.^f, Espagnol S.^g, Générumont S.^h, Loubet B.^h

^aARVALIS-Institut du végétal, Station expérimentale de La Jaillière, 44370 La Chapelle St Sauveur, France

^bInstitut de l'élevage, Monvoisin- BP 85225, 35652 Le Rheu Cedex, France

^cINRA UMR SAS, 4 rue de Stang Vihan, 29 000 Quimper, France

^dUNIFA, Le diamant A, 92909 Paris La Défense, France

^eCETIOM, BP 52627, 31326 Castanet Tolosan Cedex, France

^fACTA, 149 rue de Bercy, 75595 PARIS Cedex 12, France

^gIFIP, La Motte au Vicomte, BP 35104, 35651 Le Rheu Cedex, France

^hAgroParisTech, UMR 1091 EGC, F-78850 Thiverval-Grignon, France

1. Background & Objectives

Atmospheric ammonia is becoming a great challenge for French agriculture, due to its economic and environmental impacts. On the one hand, the increasing prices of mineral fertilizers enhance the need for improving the efficiency of mineral and organic fertilization while on the other hand, air quality regulations are becoming more stringent. Although scientific studies were carried out in the past two decades in France (Générumont and Cellier, 1997; Morvan, 1999; Le Cadre, 2004), there is still a lack of field experiments designed to assess the best strategy for reducing ammonia emissions in different production systems. This situation is merely caused by the lack of a simple method than those classically available to measure ammonia emissions in the field. Funded by the French State CASDAR program, the “VOLAT’NH3” research project has been launched in 2009 with two main purposes: 1) to develop a simple method to measure ammonia emissions based on the inverse modelling approach (Loubet et al., 2010) using batch diffusion NH₃ concentration sensors (alpha badges, Sutton et al. 2001), 2) to use this method to test the sensitivity to ammonia emissions from various mineral and organic fertilizer and the effectiveness of some agricultural practices to reduce emissions following fertilization. This paper presents the first results of the project.

2. Materials & Methods

Eight field experiments were carried out in spring 2011 (Table 1 for two examples). Plots were statistically randomized with 2 replicates per treatment (field of at least 400 m²). Alpha badges were placed at two heights (30 and 100 cm from crop or soil) in each field and exposed sequentially at 6 times post application (6 h, 1 day, 2 days, 3 days, 6 days, 20 days). Some alpha badges were placed on background measurements masts located away from the field and at a height of 3 m.

Table 1. Main characteristics of two experiments

Experiment/ crop [@]	Soil characteristics (0-25 cm)				Treatment	Total N rate* (kgN.ha ⁻¹)	N-NH ₄ ⁺ rate** (kgN.ha ⁻¹)	N-NO ₃ ⁻ rate*** (kgN.ha ⁻¹)
	Clay (g.kg ⁻¹)	Silt (g.kg ⁻¹)	Tot.C (g.kg ⁻¹)	pH				
Bernienville 2011 / ww gs Z30	132	770	7.6	6.9	0 N	0	0	0
					AN	100	50	50
					UAN	100	25	25
Derval 2011 / bs	184	507	19.9	6.4	0 N	0	0	0
					Cattle slurry on surface	135	60	0
					Cattle slurry incorporated	135	60	0

0N = without N application; AN=Ammonium nitrate; UAN=Urea Ammonium Nitrate; [@]ww gs Z30 = winter wheat at growth stage zadoks 30, bs = bare soil; *Organic and mineral nitrogen; **NH₄⁺ form nitrogen; ***NO₃⁻ form nitrogen

3. Results & Discussion

The variability of the NH_3 concentrations between replicates is small, indicating a rather good accuracy of the method. The climatic context of spring 2011 in France favoured large ammonia emissions (almost no rainfall and warm temperatures during experiments). Concerning mineral fertilizers, we measured larger NH_3 concentrations for UAN compared to AN in non-calcareous soil (Figure 1a for example). The same experiment carried out in calcareous soil (soil pH = 8.3, data not shown) suggests the same emission rate for both fertilizers. The ammonia concentrations were larger than the background during almost one week following application. For the slurry application (Figure 1b for example), we can see the strong effect of slurry incorporation. Moreover, the emission kinetic is quite different from mineral fertilizer. Almost all ammonia is volatilized during the first two days after applications. These results are consistent with those already published in France and elsewhere. There is still work to be done to get from ammonia concentrations to nitrogen fluxes, using the method developed and presented in Loubet et al. (2010 and 2011).

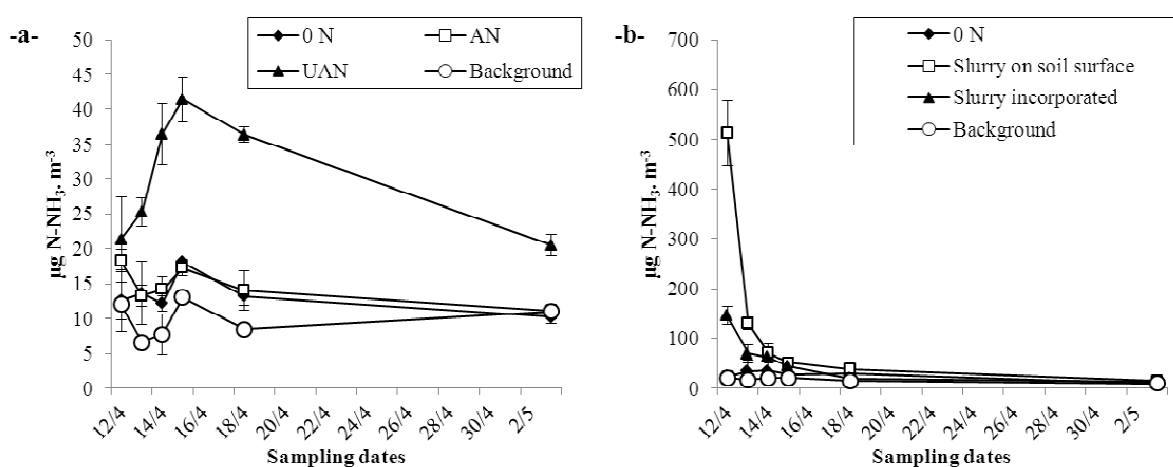

Figure 1. Ammonia concentrations at 30 cm height following mineral fertilizer applications in Bernienville 2011 experiment (-a-) and cattle slurry application in Derval 2011 experiment (-b-). Vertical bars are standard deviations.

4. Conclusion

These preliminary results, obtained by using a new easy to use method of measuring ammonia volatilisation in the field, are promising. The method should help develop strategies of ammonia emission reduction in various French agricultural contexts.

References

- Génermont, S. and Cellier, P. 1997. A mechanistic model for estimating ammonia volatilization from slurry applied to bare soil. *Agricultural and Forest Meteorology* 88,145-167.
- Le Cadre, E. 2004. Modélisation de la volatilisation d'ammoniac en interaction avec les processus chimiques et biologiques du sol, Le modèle Volt'Air. Ph.D., Institut National Agronomique Paris-Grignon, Paris.
- Loubet, B., Génermont, S., Ferrara, R., Bedos, C., Decuq, C., Personne, E., Fanucci, O., Durand, B., Rana, G. and Cellier, P., 2010. An inverse model to estimate ammonia emissions from fields. *European Journal of Soil Science* 61, 793-805.
- Loubet, B., Génermont, S., Personne, E. and Massad, R.S., 2011, Can we estimate ammonia emissions by inverse modelling with time averaged concentrations? Poster presented at the "Nitrogen and Global Change. Key findings and future challenges" Conference, Edinburgh, 11-14 April 2011.
- Morvan, T. 1999. Quantification et modélisation des flux d'azote résultant de l'épandage de lisier. Thèse de doctorat de l'Université, Université Paris 6, Paris.
- Sutton, M.A., Tang, Y.S., Miners, B., Fowler, D., 2001. A new diffusion denuder system for long-term regional monitoring of atmospheric ammonia and ammonium. *Water Air and Soil Pollution: Focus* (1), 145-156.

Ammonia volatilization after field application of biogas residues: model based scenario analysis of crop specific emissions

Pacholski, A., Gericke, D, Ni, K., Kage H.

Institute of Crop Science and Plant Breeding, Christian-Albrechts-University, Kiel, Germany

1. Background & Objectives

There is a strong trend of increasing biogas production on agricultural farms throughout Europe. In Germany actual numbers have reached ca. 7000 biogas plants (FNR, 2012). Most of those plants are operated by co-fermentation of animal slurries and energy crops. Due to their comparatively high biomass yields, silage maize is the dominant biogas crop in Germany, but whole crop cereals and grasses as well as sugar beet are also used as substrates. The main co-products of biogas production are biogas residues (BR) which are recycled as N-fertilizers. However, due to high pH values and NH_4^+ -N concentrations field applied BR are characterized by higher specific NH_3 losses than those from application of animal slurries (Ni et al., 2011). Ammonia (NH_3) emissions contribute to eutrophication and soil acidification and are a major component of eco-balances for agricultural production systems. The production of different energy crops require varying application dates and doses of N, resulting in crop specific NH_3 losses. However, ammonia emissions mainly depend on weather and canopy conditions, so that it is difficult to derive mean/median NH_3 losses from field measurements of 1-2 years duration compared to losses over a larger time span with highly dynamic weather conditions (e.g. decade). Therefore, a model based scenario analysis of NH_3 losses after field application of BR was carried out for different energy crops based on 12 years of weather data in the North of Germany.

2. Materials & Methods

Ammonia emissions were simulated for the years 1997-2008 with a validated dynamic NH_3 loss model described in detail in Gericke et al. (2012). The model includes the effects of slurry pH, precipitation, wind speed, and temperature on NH_3 losses. The model also allows the simulation of the effects of canopy characteristics (e.g. Leaf Area Index) and application method (incorporation, trail hoses) on the emissions. Calculations were done with a time step of 10 minutes for a time span of 5 days after application. Typical energy crops and weather data from three agro regions in the Federal State of Schleswig-Holstein, Northern Germany, were used: 1) eastern moraines (fertile loamy soil) close to the Baltic Sea; 2) central sandy outwash plain (sandy soil); 3) coastal marsh (clayey soil) neighbouring the North Sea. Crop rotations as well as N levels and application dates are summarized in Table 1. Due to slower crop development in the marsh area biogas residues were applied 2 weeks later than at the other sites. Simulations were done for a typical BR with a pH of 7.8, a dry matter content of 5.9% and 56% of NH_4^+ -N of total N. BR were applied according to total N content by trail hoses. BR applied before seeding of maize and sugar beet are incorporated by a cultivator (Table1). Weather data were obtained from 3 separate weather stations.

Table 1. Crops, N doses and application dates for BR applied by trail hoses covered in the scenario analysis

Crop rotation	Crop	kg N_{tot} ha ⁻¹	Application Date
A	Maize	160 (incorp. after 4 h)	Mid April
B	Rye grass (4 cuts)	120, 80, 60, 60	Mid March, Mid May, Begin July, Begin August
C	Winter Wheat + Rye Grass	80, 80, 80 (rye grass)	Mid March, Mid April, Begin August
D	Sugar beet	70 (incorp. after 4 h), 70	Mid April, Mid May
E	Rape seed	120, 80	Mid March, Mid April

3. Results & Discussion

Simulated NH_3 losses varied strongly between years (Figure 1). Mean losses ranged between 2% and 40% of $\text{NH}_4^+\text{-N}$ applied. Incorporated BR showed the lowest emissions, and emissions after application by trail hoses increased with higher temperatures at summer applications. There was a negative relationship between N application rates and relative NH_3 losses. Silage maize and sugar beet with incorporated BR showed the lowest relative NH_3 losses compared to crops with BR application by trail hoses with the highest emissions for rye grass. The trends were similar for all agro-regions of which the marsh was characterized by about 5% higher emissions. As application dates were not adapted to crop growth and not changed between years the highest losses indicate maximum losses under unfavourable, probably non-practical conditions. However, varying the application date in a time frame of a week showed only minor effects on the results in a simulation test. Effects of annual weather dynamics seem to superimpose effects of choice of application date.

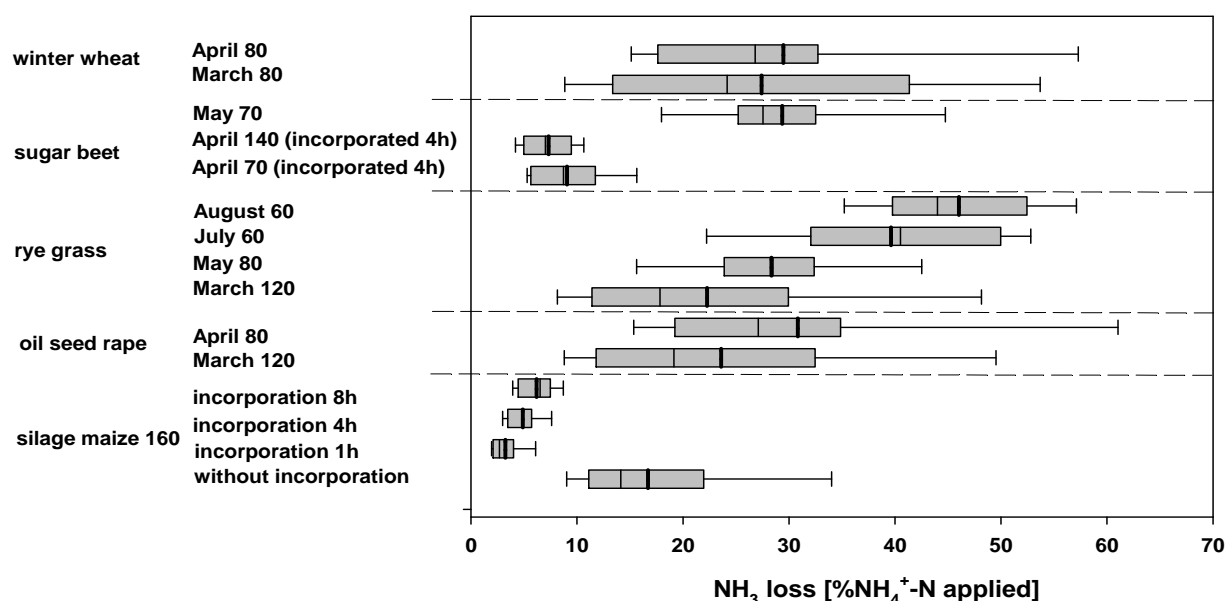

Figure 1. Simulated cumulative NH_3 losses 5 days after application of biogas residues, 1997 – 2008 ($n = 12$), Hohen-schulen, Germany; values = $\text{kg N}_{\text{tot}} \text{ha}^{-1}$ applied, error bars = 5% - 95% quintile, thin line= median, thick line = mean.

4. Conclusion

Simulation of NH_3 losses after application of BR using weather data from 1997-2008 showed a high variability of NH_3 losses which questions static emission factors for NH_3 losses. Due to the high pH-value field applied BR showed very high emissions which may strongly decrease the environmental benefit of energy production by biogas. With respect to NH_3 emissions silage maize and sugar beet are favourable as compared to winter cereals or grass. High BR application rates with incorporation resulted in the lowest simulated relative NH_3 emissions.

References

- FNR (Fachagentur Nachwachsende Rohstoffe) 2012. url: <http://mediathek.fnr.de/grafiken/daten-und-fakten/bioenergie/biogas/entwicklung-biogasanlagen.html>, 26.03.2012
- Gericke D., Bornemann L, Kage H. and Pacholski A. 2011. Modelling ammonia losses after field application of biogas slurry in energy crop rotations, *Water, Air & Soil Pollution* 223, 29–47.
- Ni K., Pacholski A., Gericke D. and Kage H. 2011. Analysis of ammonia losses after field application of biogas slurries by an empirical model. *Journal of Plant Nutrition and Soil Science*. online: 22 Nov 2011, DOI: 10.1002/jpln.201000358

Ammonia volatilization from banded urea: Impact of incorporation depth and rate of application

Rochette, P.^a, Angers, D.A.^a, Chantigny, M.H.^a, Peslter, D.^a, Bertrand, N.^a, Gasser, M.-O.^b

^aAgriculture et Agroalimentaire Canada, Québec city, QC, Canada

^bInstitut de recherche et de développement en agro-environnement, Québec city, QC, Canada

1. Background & Objectives

Surface application of urea can result in ammonia volatilization losses up to 50% of applied N. It was recently showed than when urea is banded, the high ammonium N concentration as well as the large rise in soil pH can result in high soil NH₃ concentrations and losses up to 30% of the applied urea-N (Rochette et al., 2009a, b). In this study, we conducted two field experiments to determine the impact of depth of incorporation and rate of application on the ammonia volatilization losses from banded urea.

2. Materials & Methods

The study was conducted at the IRDA research farm located near Québec City, Canada on a silty clay loam soil. In 2009, NH₃ volatilization was measured using wind tunnels on experimental plots where urea was banded at rates of 0, 80, 120, 160 and 200 kg N ha⁻¹ at the bottom of a narrow trench (depth: 5 cm; width: 8 cm) made with hand tools. The effects of incorporation depth were investigated in 2010 on plots receiving urea at a rate of 230 kg N ha⁻¹ banded at depths of 0, 2.5, 5.0, 7.5 and 10 cm in trenches (width: 8 cm). Soil samples from these bands were collected throughout the experiments for determination of pH and extraction and measurement of NH₄⁺ and NO₃⁻ + NO₂⁻ concentrations.

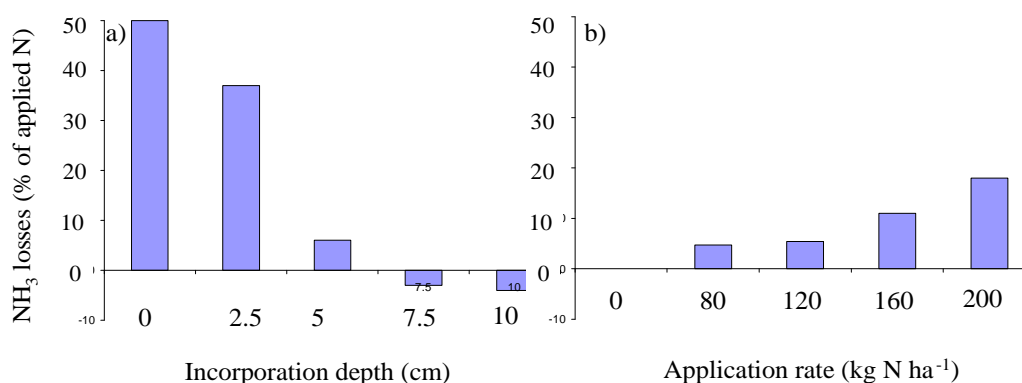

Figure 1. Cumulative NH₃ losses following banding urea in response to a) incorporation depth and b) application rate.

3. Results & Discussion

Banding urea on the soil surface resulted in cumulative NH₃ emissions of approximately 50% of applied N (Figure 1a). Losses were also very high when urea was placed at 2.5 cm (37%) but were ≤ 5% at depths of 5 cm or more. Cumulative emissions increased exponentially with urea application rate with values of 5 % of applied N at rates of 80 and 120 kg N ha⁻¹ to near 20% at 200 kg N ha⁻¹ (Figure 1b).

The magnitude of cumulative volatilization losses were related to increases in NH₄-N and in soil pH sampled over the band. Again, the relationship was non-linear with greater slopes at higher values of NH₄ content and pH (Figure 2). Such non-linear relationships suggest that soil free NH₄ and pH was kept at relatively low levels that prevented high volatilization until adsorption sites on soil

particles were saturated and soil pH buffer capacity was exceeded. Past that threshold, high soil $\text{NH}_4\text{-N}$ concentration and pH contributed to high NH_3 concentrations and increased volatilization.

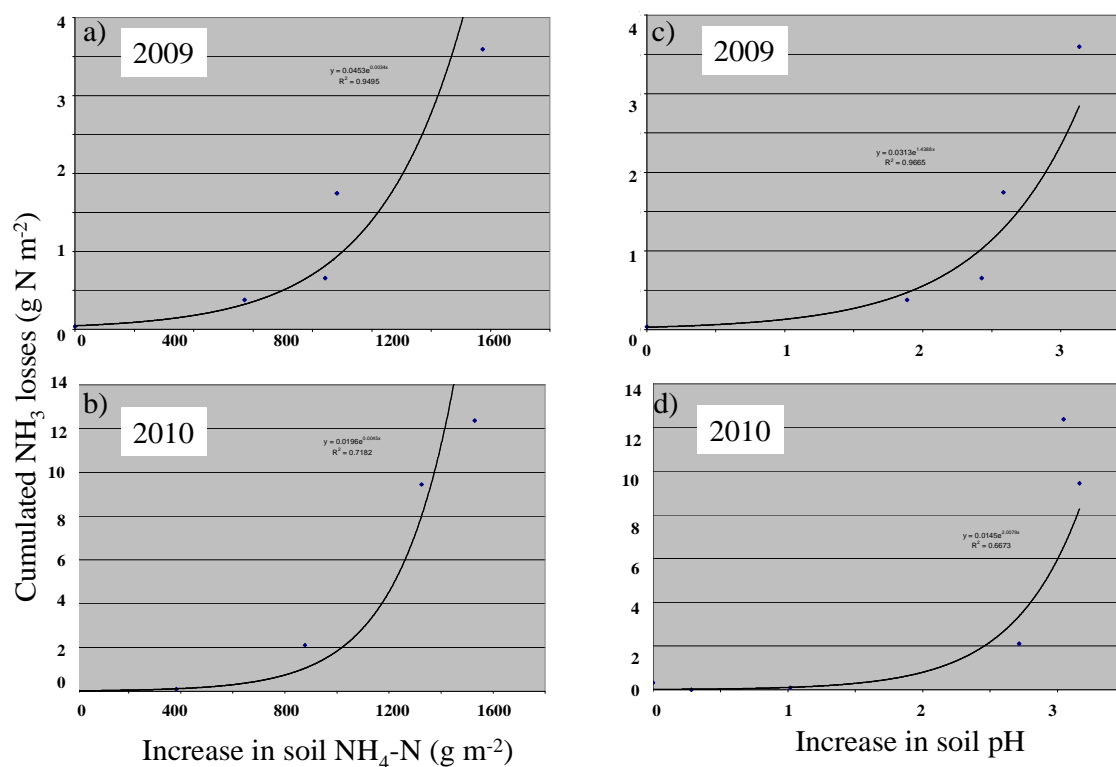

Figure 2. Relationships between cumulative NH_3 losses and maximum increase in a) soil NH_4 content and b) pH.

4. Conclusion

This work confirms that substantial NH_3 volatilization can occur when urea is applied in bands. Under the conditions of the experiments, incorporation of banded urea at ≥ 5 cm depth and application rates ≤ 120 kg N ha^{-1} kept cumulative losses $\leq 5\%$ of applied N. However, the non-linear relationships between cumulative losses and soil NH_4 content and pH suggest that soil parameters such as CEC, pH and pH buffer capacity are important factors controlling emissions following banding urea. Future work should aim at assessing the importance of these soil properties on the volatilization losses from sub-surface banded urea.

References

- Rochette, P., Angers, D.A., Chantigny, M.H., Bertrand, N., Gasser, M.-O. and MacDonald J.D. 2009a. Reducing ammonia volatilization in a no-till soil by incorporating urea and pig slurry in shallow bands. *Nutrient Cycling in Agroecosystems* 84, 71-80.
- Rochette, P., Angers, D.A., Chantigny, M.H., Bertrand, N., Gasser, M.-O. and MacDonald, J.D. 2009b. Banding of urea increased NH_3 volatilization in a dry acidic soil. *Journal of Environmental Quality* 38, 1383-1390.

Ammonia volatilization from crop residues - contribution to total ammonia volatilization at national scale

De Ruijter, F.J., Huijsmans, J.F.M.

Plant Research International, Wageningen University and Research Centre, P.O. Box 616, 6700 AP Wageningen, The Netherlands

1. Background & Objectives

To protect the environment, the European Union (EU) has adopted the National Emission Ceilings (NEC) directive (EC, 2001). This directive sets national goals for nitrogen oxides and ammonia emissions. Nitrogen (N) may be lost as ammonia from crop residues left on the soil surface. When residues are incorporated into the soil, ammonia volatilization is eliminated (de Ruijter et al., 2010; Janzen and McGinn, 1991; Mohr et al., 1998). The objective of this paper is to assess the ammonia volatilization from a range of crop residues at a national level based on the N content of the residues, cultivated area and management.

2. Materials & Methods

Literature was used to derive a relation for the ammonia volatilization depending on the N-content of crop residue. National statistics on cultivated areas, literature and expert knowledge were used to assess the area cultivated by different crops, the N content of crop residues and the management of crop residue. Ammonia volatilization from crop residues in the Netherlands was calculated per crop by multiplication of: cropped area (ha), N in residues (kg ha^{-1}), volatilization (% of total N in kg ha^{-1}) calculated from N content (g kg^{-1} dry matter) by the regression equation derived from literature, and amount and fraction of the residues that contributes to ammonia volatilization (based on degree of mixing with soil at harvest and duration between harvest and incorporation).

3. Results & Discussion

Relatively high ammonia volatilization was found in studies using volatilization chambers without soil and in studies where a thick mulch layer of residues was applied. Therefore, these studies were excluded from regression analysis. From the remaining studies (Table 1), total ammonia volatilization at the end of the experiment was taken or when the rate of volatilization had declined to low values. The following regression equation was derived ($R^2=0.50$):

$$\text{NH}_3\text{-N volatilization (\% of applied N)} = 0.40 * \text{N content (g kg}^{-1} \text{ dry matter)} - 5.08$$

(p=0.03) (p<0.001)

Table 1. Overview of literature on ammonia volatilization from crop residues.

Source	Crops	Setup	Soil	°C	Days
1 Bremer and Van Kessel, 1992	green manure, lentil, wheat	Laboratory, jars	no	20-25	28
2 De Ruijter et al., 2010	broccoli, fodder radish, grass, leek, sugar beet, yellow mustard	Volatilization chambers under rain shelter	yes	-4-14	37
4 Janzen and McGinn, 1991	lentil green manure	Volatilization chambers	yes	avg. 25	14-56
6 Mannheim et al., 1997	beans, potato, sugar beet	Wind tunnels	yes	~10	32
7 Mohr et al., 1998	alfalfa	Chambers in greenhouse	yes	nr	50
8 Ribas et al., 2010	velvet bean	Chambers placed over field	yes	avg. 21	30
9 Whitehead and Lockyer, 1989	grass	Field, wind tunnels	yes	avg. 15.6	28

nr=not reported

The largest contribution to ammonia volatilization at the national scale is from grassland residues that arise during mowing and grazing (Figure 1). Of the arable crops, potato haulms show the largest ammonia volatilization (Figure 1, right). In our calculations, this is mainly derived from seed potatoes where the haulms are killed by herbicides.

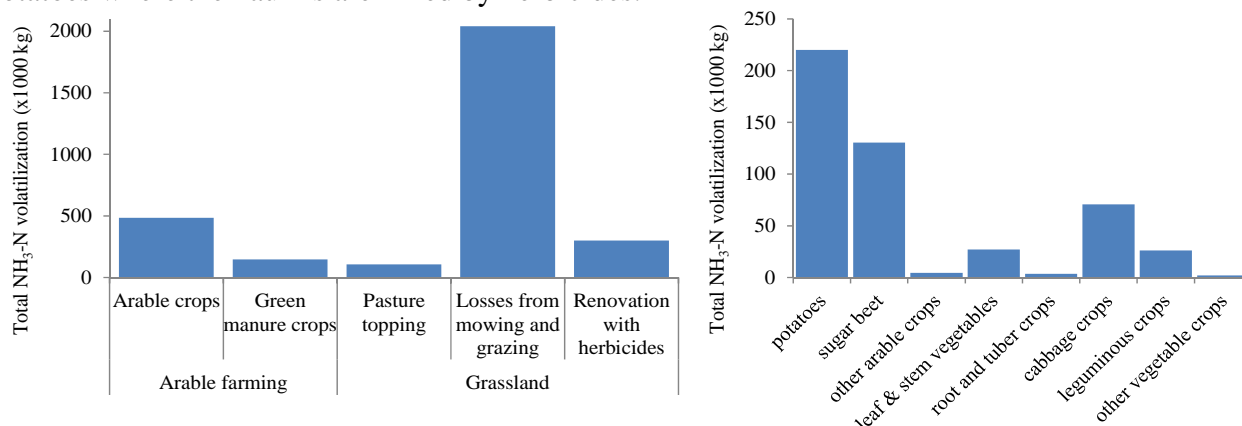

Figure 1. Total ammonia volatilization in the Netherlands from various crops

Ammonia volatilization was estimated by the relationship between NH₃-N volatilization (as % of N in residues) and the N content (in g kg⁻¹ dry matter). Variation in N content of the residues affects the % of total N that volatilizes as NH₃ and the total N in the residues. Therefore, a reduction in N content of the residues has a more than proportionate effect on ammonia volatilization. For example, reducing the N content from 40 to 36 g kg⁻¹ (10%) reduces ammonia volatilization (in kg NH₃-N ha⁻¹) by 23%. At a lower N content this effect is even larger.

4. Conclusion

Crop residues may substantially contribute to the national ammonia losses. Ammonia volatilization from crop residues is related to their N content. Incorporation into the soil or decreasing fertilizer inputs may therefore have a large impact on ammonia volatilization from crop residues.

References

- Bremer E. and Vankessel C. 1992. Plant-available nitrogen from lentil and wheat residues during a subsequent growing-season. *Soil Science Society of America Journal* 56, 1155-1160.
- Cherry K.A., Shepard M., Withers P.J.A. and Mooney S.J. 2008. Assessing the effectiveness of actions to mitigate nutrient loss from agriculture: A review of methods. *Science of the Total Environment* 406, 1-23.
- De Ruijter F.J., Huijsmans J.F.M. and Rutgers B. 2010. Ammonia volatilization from crop residues and frozen green manure crops. *Atmospheric Environment* 44, 3362-3368.
- EC 2001. Directive 2001/81/EC of the European Parliament and of the Council of 23 October 2001 on national emission ceilings for certain atmospheric pollutants. *Official Journal L* 309, 22 (accessed 27.11.01). European Communities, Brussels.
- Janzen H.H. and McGinn S.M. 1991. Volatile Loss of Nitrogen During Decomposition of Legume Green Manure. *Soil Biology and Biochemistry* 23, 291-297.
- Manneim T., Braschkat J. and Marschner H. 1997. Ammonia emissions from senescing plants and during decomposition of crop residues. *Zeitschrift für Pflanzenernährung und Bodenkunde* 160, 125-132.
- Mohr R.M., Janzen H.H. and Entz M.H. 1998. Nitrogen dynamics under greenhouse conditions as influenced by method of alfalfa termination. 1. Volatile N losses. *Canadian Journal of Soil Science* 78, 253-259.
- Ribas R.G.T., Santos R.H.S, Siqueira R.G., Diniz E.R., Peternelli L.A. and de Freitas G.B. 2010. Decomposition, release and volatilization of nitrogen from velvet bean (*Mucuna cinerea*) residues. *Ciencia e Agrotecnologia* 34, 878-885.
- Whitehead D.C. and Lockyer D.R. 1989. Decomposing Grass Herbage as a Source of Ammonia in the Atmosphere. *Atmospheric Environment* 23, 1867-1869.

Antecedent effect of lime on denitrification in grassland soils

Higgins, S., Laughlin, R.J., Watson, C.J.

Agri-Food and Biosciences Institute, 18a Newforge Lane, Malone Upper, Belfast BT9 5PX, Northern Ireland, UK

1. Background & Objectives

Sales of agricultural lime in Northern Ireland and the Republic of Ireland have fallen considerably during the past 30 years (DARDNI, 2011; Culleton et al., 1999) resulting in increasingly acidic soils in many areas. Soil pH has been shown to significantly affect the ratio of the end products (N_2/N_2O) of denitrification (Čuhel et al., 2010; Šimek and Cooper, 2002). The implications of lime use on this ratio were examined in a laboratory incubation study using a ^{15}N -gas-flux method, followed by isotope-ratio mass spectrometry for the analysis of ^{15}N in the gases.

2. Materials & Methods

Two grassland soils (of contrasting texture and management but similar starting pH) were selected from the basalt area of County Antrim, Northern Ireland in 2006. Soil 1 was a clay loam soil under silage management with a starting pH of 5.4. Soil 2 was a sandy loam soil under grazing management, with a starting pH of 5.3. The soils were partially air-dried and sieved to 2 mm and 15 kg sub-samples of each soil were treated with 0, 2.3, 5.7 or 18.9 g $CaCO_3$ kg^{-1} (neutralising value 56%), mixing thoroughly using a cement mixer, to obtain four pH values for each soil. The soils were placed in large polythene bags and sealed to prevent moisture loss, but maintain aerobic conditions, and incubated at 4°C for a three year period (2006 to 2009). Periodic checks on soil pH (soil and water ratio of 1:2.5 (v/v)) and volumetric moisture content were carried out. Samples of soil (100 g oven-dry (OD) weight) were placed in acid-washed 500 ml Kilner jars and received one of three ^{15}N treatments; ammonium ($^{15}NH_4NO_3$), nitrate ($NH_4^{15}NO_3$), or both moieties ($^{15}NH_4^{15}NO_3$) labelled with 60 atom % excess ^{15}N , along with 5 ml acetate (C source) and 5 ml deionised water. Each treatment was replicated three times. The ^{15}N was applied at a rate of 7.14 $\mu mol NH_4NO_3$ g^{-1} OD soil, pipetted uniformly over the soil surface. Additional water was added to each soil one week in advance of the incubation to ensure that all soils were adjusted to a water-filled pore space of 65%. The jars were covered with Parafilm to prevent moisture loss but allow gaseous exchange, and were incubated in a controlled temperature environment at 20°C. Headspace samplings were carried out on five consecutive days following the addition of treatments using polyacetyl lids containing a gas-sampling port and a viton O-ring to form a gas-tight seal. These were fitted onto each jar for a period of two hours per day. Two 15 ml headspace samples were extracted daily using a gas-tight syringe and transferred to evacuated (<100 Pa) septum capped 12ml vials, to be analysed by isotope-ratio mass spectrometry for the ^{15}N contents of the N_2O and N_2 in each vial, as described by Stevens et al. (1998). Residual Maximum Likelihood (REML) variance components analysis (Genstat Release 12) was used to examine the significance of fixed (pH, ^{15}N treatment) and random (day, soil type) affects on N_2 -N and N_2O -N fluxes.

3. Results & Discussion

During the three-year pre-incubation period, the two soils equilibrated at four different pH values: Soil 1 pH 4.7, 5.8, 7.3 and 7.7, and Soil 2 pH 4.7, 5.2, 6.6 and 7.6. The number of days following treatment addition had a significant effect ($P < 0.05$) on the flux of both N_2 and N_2O in the headspace of the jars, with the largest fluxes of being recorded two days after ^{15}N application (N_2O : Soil 1 0.0014 μmol g OD soil (Figure 1) and Soil 2 0.0018 μmol g OD soil), and N_2 : Soil 1 0.126 μmol g OD soil and Soil 2 0.179 μmol g OD soil.

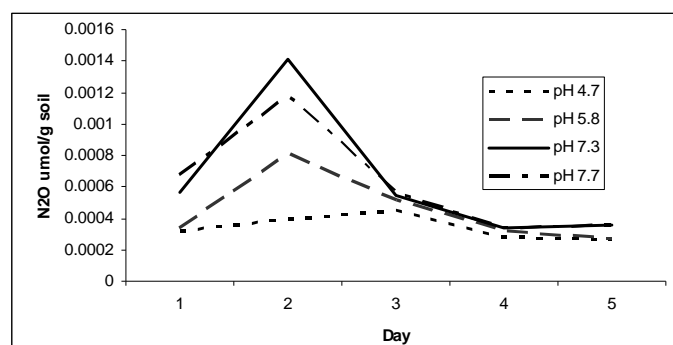

Figure 1. N₂O flux over five days following the addition of treatments, in Soil 1 at four pH values

The N₂ and N₂O fluxes increased as the pH of the soil increased ($P < 0.01$) reaching a maximum at pH 7.3 (Soil 1) and pH 7.6 (Soil 2). The amount of N applied that was emitted as N₂ (up to 23% in Soil 1 and 45% in Soil 2) greatly exceeded the amount of N emitted as N₂O (less than 1% of the N applied) (Figure 2). Greater N₂O emissions as pH increased (Figure 1), would suggest increased N₂O-reductase activity and therefore enhanced reduction of N₂O to N₂ at higher pH values. However, overall N₂O emissions were a very small % of the N applied in comparison to N₂ (Figure 2).

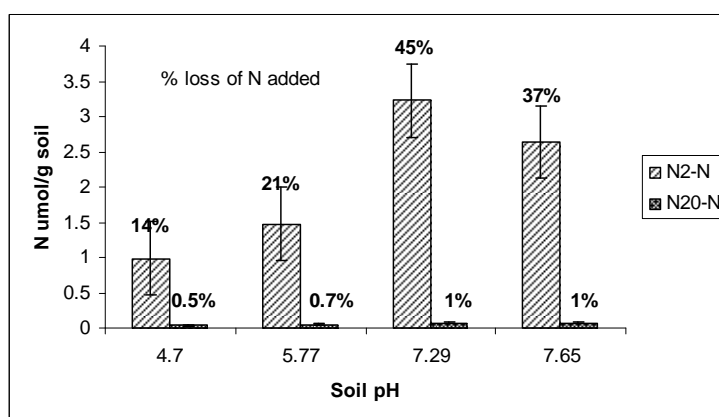

Figure 2: Cumulative loss of N₂ and N₂O from soil as a % of N applied in Soil 2 at each pH.

4. Conclusions

Lime enhances the loss of N from soil by denitrification, as both N₂ and N₂O. This can represent a significant loss of N from soil, and although emissions are dominated by N₂ as soil pH increases, it would indicate that lime is not a potential mitigation strategy for reducing N₂O emissions.

References

- Čuhel, J., Šimek, M., Laughlin, R.J., Bru, D., Chèneby, D., Watson, C.J. and Philippot, L. 2010. Insights into the effect of soil pH on N₂O and N₂ emissions and denitrifier community size and activity. *Applied and Environmental Microbiology* 76, 1870-1878.
- Culleton, N., Murphy, W.E. and Coulter, B. 1999. Lime in Irish Agriculture [Online]. Available by The Fertilizer Association of Ireland www.fertilizer-assoc.ie
- Department of Agriculture and Rural Development for Northern Ireland. <http://www.dardni.gov.uk>.
- Šimek, M. and Cooper, J.E. 2002. The influence of soil pH on denitrification: progress towards the understanding of this interaction over the last 50 years. *European Journal of Soil Science* 53, 345-354.
- Stevens, R.J., Laughlin, R.J. and Malone, J.P. 1998. Soil pH affects the processes reducing nitrate to nitrous oxide and di-nitrogen. *Soil Biology and Biochemistry* 30, 1119-1126.

Assessing N availability from municipal solid waste compost during two consecutive lettuce cycles in Italy

Fiorentino, N., Fagnano, M.

Department of Agricultural Engineering and Agronomy, University of Naples Federico II, Italy

1. Background & Objectives

Soils of the Mediterranean area are prone to severe fertility losses, if agronomic tools are not managed to counterbalance the high soil organic matter (SOM) mineralization rate of this region. Compost fertilization could be an interesting tool to increase soil fertility since its positive effects on humification, nutrient availability, porosity, structural stability and biological activity have been proven in different agricultural systems (Diacono and Montemurro, 2010). Moreover composting of the solid waste organic fraction could be a possible solution to the long-standing rubbish problem, limiting the amount of waste going to final disposal (Fagnano et al., 2011). This work focuses on the potential use of Municipal Solid Waste (MSW) compost in open field horticulture, assessing its effect on lettuce yield and soil-plant N dynamics on two consecutive cropping cycles.

2. Materials & Methods

An open-field experiment was carried out in Caivano municipality (40°56'N, 14°19'E), 12 km from Naples City (Italy), with the aim to compare the agronomic performance of 3 MSW compost doses, 10 (CF10), 30 (CF30) and 60 (CF60) Mg ha⁻¹, corresponding respectively to 56, 160 and 319 kg N ha⁻¹ (the complete experimental set up is described in Fagnano et al., 2011). The compost was stable and fully mature with a C:N ratio of 20. Treatments, including ammonium nitrate fertilization with 84 kg ha⁻¹ of N (MF) and a not fertilized control plot (NF), were laid on in a randomized complete block design with 3 replicates. The soil was sandy loam (sand, 565 g kg⁻¹; silt, 285 g kg⁻¹; clay, 150 g kg⁻¹) with high C and N content (1.89% and 0.16% respectively). Lettuce was cropped in summer (cv. *Audrian*) and winter (cv. *Sagess*), spreading mineral fertilizers at both transplant times while compost was buried only at the beginning of the experiment. Soil mineral N (SMN) and N content of plant tissues were measured by HACH® and by Kjeldahl method respectively. A simplified N balance for the 0-20 cm layer was calculated as N uptake + SMN harvest – SMN seeding to estimate available N from SOM mineralization (AvN) on NF and from fertilizers (FAvN) on the other plots. The difference between FAvN-AvN was considered as Net available N from fertilizers (NAvN). N apparent recovery (NAR) was calculated as the difference between N uptake in fertilized and not fertilized plots divided by N input (Montemurro et al., 2006). All the data were subjected to ANOVA, using the MSTAT-C software (Version 2.0), and mean separation was made by using LSD test.

3. Results & Discussion

In both cycles, marketable yield (Table 1) in C30 and C60 plots was not different from MF (average value of 47.6 and 37.9 Mg FW ha⁻¹ for the 1st and the 2nd cycle respectively) while values recorded with C10 were significantly lower than the other treatments excepting NF. At DAT 10 of the 1st cycle N uptake with the two highest compost doses was 55% lower than NF, while the value decreased of 19% with C10 (Table 1). In the 2nd cycle N uptake were highest with MF, C60 and C30 (50.6 mg N pt⁻¹ on average), while values were not different between C10 and NF and significantly lower (-38%) than the other treatments. At the end of both cropping cycles, N uptake was found at the same level among the fertilized plots (625 and 596 mg N pt⁻¹, in the two cycles respectively). N from fertilizers (NAvN) in the summer cycle is shown in Figure 1.

Table 1. Marketable yield at harvest sampling and N uptake at the beginning of the two cycles

Treatment	Yield (Mg ha ⁻¹)		N uptake (mg N pt ⁻¹)	
	1 st cycle	2 nd cycle	1 st cycle DAT 10	2 nd cycle DAT 25
NF	35.6 c	21.0 d	15.9 a	35.2 bc
C10	41.3 b	32.5 c	12.8 b	27.7 c
C30	46.4 a	35.0 bc	6.9 c	51.8 ab
C60	48.9 a	40.8 a	7.5 c	45.6 abc
MF	47.6 a	38.0 ab	16.5 a	54.4 a

Different letters indicate different means with $p < 0.05$

At DAT 10 of the summer lettuce cycle C60 showed the highest NAvN together with MF (109 kg N ha⁻¹ on average), while values were 63% lower with C10 and C30. NAvN significantly increased with the intermediate compost dose (+115%), while values did not change in C10. It was found a tendency to the decrease with MF (-79%) and a slight increase with C60 (+47%). NAR was not different with C30 and C60 (12% over the two cycles) while values with C10 and MF were higher (33%). Our results demonstrated that compost fertilization made at the beginning of the summer season at the 160 and 319 kg N ha⁻¹ rate was able to sustain N lettuce nutrition in two consecutive cropping cycles, giving yields not different from mineral fertilization. Those results are consistent with Erhart et al. (2007) showing that compost acts as a slow release fertilizer, whose low mineralization rate makes N available to plants also several months after the application to the soil. Low N uptake at the beginning of the summer cycle was probably due to the lack of N caused by the activation of soil microbiota after the fertilization. This happened only with the highest compost doses but no problems in plant nutrition occurred since N availability increased in the successive days of the summer cycle. NAvN did not increase in C10 plots probably because labile N input was too low to balance the slow N mineralization. NAR values were the same with C30 and C60 demonstrating that the 30 Mg ha⁻¹ dose can maximize N recovery and lettuce yields.

4. Conclusion

In our high fertile soil MSW compost could be a useful tool to manage N fertility in horticulture, reducing N inputs with mineral fertilizers. Nevertheless fertilization with fully stabilized compost could seriously limit crop growth in fine textured or low SOM soils where mineral N immobilization prevails on nitrification. Furthermore, compost doses need to be carefully managed in order to guaranty an adequate feeding of crops and limit hazardous N surplus. A more efficient N use could also be achieved delaying transplant date of summer season, as in well watered soils N availability from compost tends to a significant increase with the increase of soil temperature.

References

- Diacono M. and Montemurro F. 2010. Long-term effects of organic amendments on soil fertility. A review. *Agronomy for Sustainable Development* 30, 401-422.
- Erhart E., Feichtinger F. and Hartl W. 2007. Nitrogen leaching losses under crops fertilized with biowaste compost compared with mineral fertilization. *Journal of Plant Nutrition and Soil Science* 170, 608-614.
- Fagnano M., Adamo P., Zampella M. and Fiorentino N. 2011. Environmental and agronomic impact of fertilization with composted organic fraction from municipal solid waste. *Agriculture Ecosystems & Environment* 141, 100-107.
- Montemurro, F., Maiorana, M., Ferri, D. and Convertini, G. 2006. Nitrogen indicators, uptake and utilization efficiency in a maize and barley rotation cropped at different levels and sources of N fertilization. *Field Crops Research* 99, 114-124.

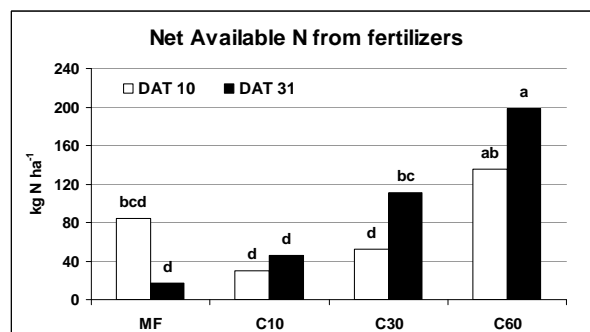

Figure 1. NAvN at DAT 10 AND 30 of the summer cycle ("treatment by date" interaction).

Assessment of the potential N mineralization/immobilization of pig slurry fractions obtained using different techniques

Fangueiro, D., Lopes, C., Olsen, L., Vasconcelos E.

UIQA, Instituto Superior de Agronomia – Technical University of Lisbon, 1349-017 Lisbon, Portugal

1. Background & Objectives

The intensification of swine production induced a strong increase of pig slurry production on isolated farms and consequent transfer of slurry to far-away fields for soil application. Slurry separation into a liquid (LF) and a solid (SF) fraction is now commonly used at farm scale as slurry management tool. The LF can then be used in fields for fertigation whereas the SF can be applied to soil directly or be composted to obtain a more valuable product. Solid-liquid separation can be performed by chemically enhanced settling and/or using mechanical processes. Jorgensen and Jensen (2009) showed that the characteristics of the solid fractions, namely the carbon (C) content and speciation depends on the technology used for slurry separation. But there is little knowledge on the effect of such technologies on the liquid fractions characteristics. Since the nitrogen (N) mineralization/immobilization rely on the C:N ratio of organic materials, it can be hypothesized that the slurry separation techniques used have influence on the characteristics of the resulting slurry fractions and especially on their potential of nitrogen mineralization /immobilization. In the present work, the liquid and solid fractions of pig slurry obtained using 6 separation techniques were characterized and their potential of N mineralization/immobilization was determined.

2. Materials & Methods

Six liquid fractions (-L) and six solid fractions (-S) were obtained by separation of pig slurry by: centrifugation (Cent-), sieving (Siev-), enhanced settling by addition of Polyacrilamide (PAM-), sediment settling (Sed-), sediment settling followed by addition of Polyacrilamide to the resulting liquid fraction (Sed+PAM-), sediment settling followed by filtration of the resulting liquid fraction (Sed+Filt-). These 12 slurry fractions as well as the whole slurry (WS) were characterized in terms of dry matter, organic carbon total nitrogen and ammonium nitrogen.

Table 1. Main characteristics of the Liquid and Solid fractions obtained by separation of pig slurry using different techniques (N=3)

	Dry matter (g kg ⁻¹)	Organic C (g kg ⁻¹)	Total N (g kg ⁻¹)	NH ₄ ⁺ -N (mg kg ⁻¹)	C:N ratio
WS	82.52	21.45	4.21	1338.04	5.10
Cent-L	4.93	1.09	1.44	1217.88	0.75
cent-S	251.75	68.50	10.40	1626.74	6.59
Siev-L	12.80	4.42	4.08	1304.77	1.08
Siev-S	160.12	52.86	6.03	1364.49	8.76
Sed-L	5.68	1.33	1.38	1266.88	0.96
Sed-S	83.51	23.76	4.27	1305.87	5.56
PAM-L	4.84	1.12	1.38	1063.36	0.82
PAM-S	79.98	36.75	5.05	1176.65	7.28
Sed+PAM-L	4.93	1.13	1.39	1088.62	0.81
Sed+PAM-S	88.14	22.59	4.57	1258.26	4.94
Sed+Filt-L	3.63	0.63	1.30	472.36	0.48
Sed+Filt-S	196.78	55.34	8.79	621.91	6.30

An anaerobic incubation method (Fangueiro et al., 2008) was used to assess the potential N mineralization/immobilization. An amount of a specific slurry fraction corresponding to 0.03 g of N was added to 10 g of field moist soil in a 60 ml syringe and the amount of water was adjusted to have a total amount of 25 ml. 8 replicates of each slurry fraction and non-separated whole slurry

were performed to allow one half to be incubated for 7 days at 40° C, whilst the other half were extracted immediately with 1 M KCl. Potential mineralization/immobilization (PNM) was calculated as the difference between post- and pre-incubation NH_4^+ -N contents.

3. Results & Discussion

The main characteristics of the liquid and solid fractions obtained here vary notably according to the separation techniques used, namely in terms of total N and organic C (Table 1). All separation techniques except Sed and Sed+PAM generated solid fractions with higher organic C and total N concentrations than the WS or respective LF.

Potential nitrogen mineralization was observed with the WS and all the SFs with values of PNM close to 5% of the organic N applied (7.5% in Cent-S) (Figure 1). The LF obtained showed higher variability in terms of PNM with 2 leading to N mineralization, 2 to N immobilization and 2 did not exhibit any variation. No correlation was found between the PNM value of the different fractions studied and their C:N ratio albeit this parameter is usually used to predict the mineralization/immobilization of the organic residues. Hence, it is to believe that other parameters influenced by the separation techniques may interfere in the nitrogen mineralization/immobilization process.

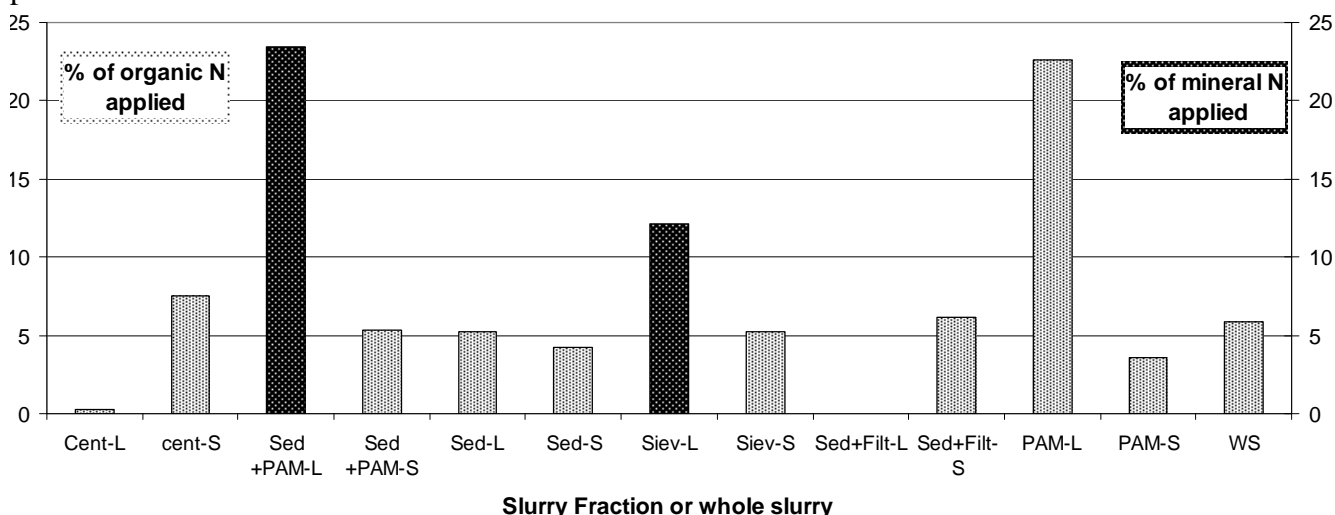

Figure 1. Potential of nitrogen mineralization/immobilization of SF and LF obtained by separation of pig slurry using different techniques (N=4)

4. Conclusions

Our results show that most separation techniques allow an efficient removal of solids but the composition of the resulting fractions depends on the separation technique. The choice of the separation technique has to consider the final use of the resulting fraction. Nevertheless, technologies to perform centrifugation and sieving are expensive and energy consuming whereas the separation by sediment settling imply limited investments. According to previous results from Fanguero et al. (2008), the assessment of the particle size distribution of the fraction obtained with different separation technique might help to understand why the separation techniques affect the PNM of the resulting fractions.

References

- Fanguero, D., Bol, R. and Chadwick, D. 2008. Assessment of the potential N mineralization of six particle size fractions of two different cattle slurries. *Journal of Plant Nutrition and Soil Science*, 171, 313-315.
- Jorgensen S. and Jensen L. 2009. Chemical and biochemical variation in animal manure solids separated using different commercial separation technologies. *Bioresource Technology*, 100, 3088-3096.

Biochar reduces nitrate leaching in an apple orchard

Ventura, M.^a, Sorrenti, G.^b, Panzacchi, P.^b, Tonon, G.^a

^aFaculty of Science and Technology, Free University of Bolzano/Bozen, Bolzano/Bozen, Italy

^bDepartment of Fruit Tree and Woody Plant Sciences, University of Bologna, Bologna, Italy

1. Background & Objectives

Biochar is a by-product of pyrolysis that is the thermal decomposition of different organic sources under limited oxygen concentration at relatively low temperatures aimed at producing energy by syngas combustion. The incorporation of biochar into the soil has been proposed as a valid strategy to increase soil C storage. Furthermore, biochar has shown to promote plant growth increasing soil nutrient retention (Lehmann and Joseph, 2009). In particular, biochar has shown to reduce ammonium leaching in acidic tropical soils (Lehmann et al., 2003) and in laboratory conditions (Ding et al., 2010; Laird et al., 2010), however, information about alkaline soils and in field conditions is still totally lacking. The aim of the present study is to understand the potential of biochar for increasing soil N retention in calcareous, sub-alkaline soil.

2. Materials & Methods

In spring 2009, 10 Mg of biochar per hectare was applied in a mature apple (*Malus domestica* Borkh.) orchard, growing on a calcareous, sub-alkaline soil (pH 7.3) and located in the Po Valley (Italy). Biochar was incorporated into the first 20-cm soil layer by surface soil ploughing. A similar soil perturbation was applied to control plots. Cumulative nitrate (NO_3^-) and ammonium (NH_4^+) leaching was measured 4 months after biochar addition and in the following year, by using ion-exchange resin lysimeters (Susfalk and Johnson, 2002) installed below the ploughed soil layer. Leaf analysis was conducted to assess plants nutritional status. Soil pH and microbial biomass were also determined in treated and control plots.

3. Results & Discussion

After 4 months, biochar treatment did not produce significant differences in the total amount of leached nitrogen, both as nitrate and ammonium (Figure 1a). On the contrary, in the following year NO_3^- leaching was significantly reduced in biochar treated soil in comparison to untreated soil (Figure 1b).

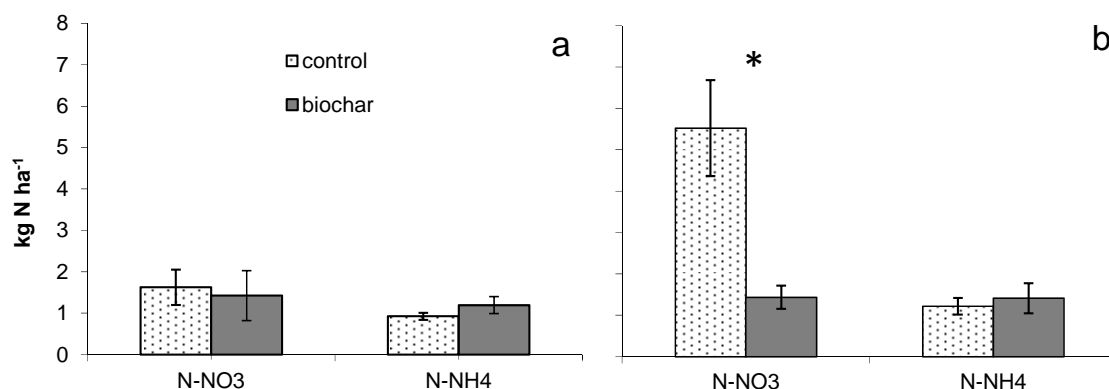

Figure 1. Cumulative ammonium nitrogen (N-NH_4) and nitrate nitrogen (N-NO_3) leaching after 4 months from biochar addition (a) and after the following year (b). The symbol * denotes a statistically significant difference for $p < 0.05$.

Soil applied biochar did not affect leaf chlorophyll (Chl) content, leaf dry weight and macronutrient content, while only leaf Zn concentration slightly decreased in amended soil (Table 1). Biochar treatment did not significantly affect microbial biomass nitrogen and soil pH values (data not shown). The observed NO_3^- leaching reduction may be due to different mechanisms, such as adsorption of NH_4^+ by charcoal, or the inhibition of nitrification with the consequent ammonium adsorption by clay particles (Berglund et al., 2004; Taghizadeh-Toosi et al., 2011). However, direct adsorption of nitrate by biochar particles cannot be totally excluded. The higher efficacy of biochar observed in the second year of the experiment might be due to a change in biochar properties with time.

Table 1 Effect of biochar treatment on leaf mineral concentration

	Leaf Chl	Leaf weight	N	P	K	Ca	Mg	Fe	Mn	Cu	Zn
Unit	Spad Units	g leaf ⁻¹ (dw)	g kg ⁻¹ (dw)			mg kg ⁻¹ (dw)					
Control	42.7	0.26	21.1	2.6	10.0	16.6	4.2	77.3	188.6	5.9	46.0
Biochar	43.8	0.26	21.2	2.3	10.3	17.0	4.2	66.5	179.5	6.3	34.8
	<i>ns</i>	<i>ns</i>	<i>ns</i>	<i>ns</i>	<i>ns</i>	<i>ns</i>	<i>ns</i>	<i>ns</i>	<i>ns</i>	<i>ns</i>	*

* = significant for $p < 0.05$; *ns* = not significant

4. Conclusion

Even if the underlying physico-chemical mechanism is still unclear, the present study shows, for the first time, that soil biochar addition can significantly decrease nitrate leaching also in a sub-alkaline soil of temperate climates.

References

- Berglund, L.M., DeLuca, T.H. and Zackrisson, O. 2004. Activated carbon amendments to soil alters nitrification rates in Scots pine forests, *Soil Biol Biochem* 36,2067-2073.
- Ding, Y., Liu, Y-X., Wu, W-X., Shi, D-Z., Yang, M. and Zhong, Z-K. 2010. Evaluation of Biochar Effects on Nitrogen Retention and Leaching in Multi-Layered Soil Columns, *Water Air Soil Pollution* 213,47-55.
- Laird, D., Angelis, P., Wang, B., Horton, R. and Karlen, D. 2010. Biochar impact on nutrient leaching from a Midwestern agricultural soil, *Geoderma* 158,436-442.
- Lehmann, J. and Joseph, S. 2009. Biochar for environmental management: An introduction, In: Lehmann J., Joseph S. (eds), *Biochar for environmental management: Science and technology*, Earthscan, London pp 1-12.
- Lehmann, J., Pereira da Silva, J., Steiner, C., Nehls, T., Kech, W. and Glaser, B. 2003. Nutrient availability and leaching in an archaeological Anthrosol and a Ferralsol of the Central Amazon basin: fertilizer, manure and charcoal amendments, *Plant and Soil* 249:343-357.
- Susfalk, R.B. and Johnson, D.W. 2002. Ion exchange resin based soil solution lysimeters and snowmelt solution collectors, *Communications in Soil Sciences and Plant Analysis* 33,1261-1275.
- Taghizadeh-Toosi, A., Clough, T.J., Condron, L.M., Sherlock, R.R., Anderson, C.R. and Craigie, R.A. 2011. Biochar incorporation into pasture soil suppresses in situ nitrous oxide emissions from ruminant urine patches, *Journal of Environmental Quality* 40,468-476.

Can an urease inhibitor mitigate N₂O and NO emissions from urea fertilized Mediterranean agrosystems?

Sanz-Cobena, A.^a, Ábalos, D.^a, Misselbrook, T.^b, Sanchez-Martín, L.^a, Téllez, A.^a, García-Marco, S.^a, Vallejo, A.^a

^aETSI Agrónomos, Technical University of Madrid, Ciudad Universitaria, 28040 Madrid, Spain

^bRothamsted Research, North Wyke, Okehampton, Devon EX20 2SB, UK

1. Background & Objectives

Urea is the cheapest and most commonly used form of inorganic N fertilizer worldwide, accounting for c. 50% of inorganic N use (Harrison and Webb, 2001). Nevertheless, the low efficiency of N-urea use by crops represents a threat to environmental quality and public health. It has been estimated that up to 60% of N-urea applied could be lost to the atmosphere via ammonia (NH₃), nitric oxide (NO) and nitrous oxide (N₂O), and to water streams through nitrate (NO₃⁻) leaching. Among the proposed mitigation strategies to prevent N losses from urea fertilisation, urease inhibitors have been shown to effectively reduce NH₃ volatilization (Sanz-Cobena et al., 2008). Additionally, few studies examine the effectiveness of NBPT to decrease the NO and N₂O production rate in urea fertilized croplands (Ding et al., 2011). Results from two field experiments were used to evaluate the effectiveness of the urease inhibitor N-(n-butyl) thiophosphoric triamide (NBPT, trade name Agrotain[®]) on abating N oxides emissions from urea fertilized agricultural soils in Central Spain.

2. Materials & Methods

All experiments were carried out in the same location (i.e. “El Encín” field station, latitude 40°32'N, longitude 3°17'W). The mean annual temperature and rainfall in this area are 13.2°C and 430 mm, respectively. The soil type is a Calcic Haploxerepts (Soil Survey Staff, 1992) with a sandy clay loam texture (clay, 28%; silt, 17%; sand, 55%) in the upper (0–28 cm) horizon. The cropping systems that were studied were barley and maize crops. Losses of NO and N₂O were determined by static chambers (Sanchez-Martín et al., 2008). Measurements were carried out 3, 6, 9, 12 days after application in the 2 weeks after urea fertilization, and then once a week until the end of the sampling period. Urea (U) and NBPT coated urea (U+NBPT) (0.20% w/w) were applied in granular form. The N application rate was 100 and 250 kg N ha⁻¹ for barley and maize, respectively. Following local agricultural practices, maize was irrigated by 404 mm and barley was set as a rainfed crop. A soil without N fertilizer applied was settled as a Control soil (C).

3. Results & Discussion

NBPT decreased N₂O-N emissions from urea by approximately 74% and 55% in the barley and the maize crop, respectively. An abatement of 67% and 88% was measured for the emissions of NO (Figure 1). This effect was mostly observed when nitrification was expected to be the main pathway in the production of these reactive N compounds (WFPS ≤ 55%; NO/N₂O > 1). In the case of maize, this occurred within the first month after fertilization and it was associated to a slightly controlled irrigation (1 irrigation event and total amount of 9 mm in the 2 weeks following fertilization). In this study, the abating effect of NBPT over N₂O fluxes was greater than that previously reported elsewhere (e.g. Zaman et al., 2009). NBPT delayed urea hydrolysis and this may have explained the lower concentration of ammonium (NH₄⁺-N) measured in this soil. This reduction in the size of the NH₄⁺-N pool may have reduced the nitrification rate in such a way that the production of N₂O and NO was also affected.

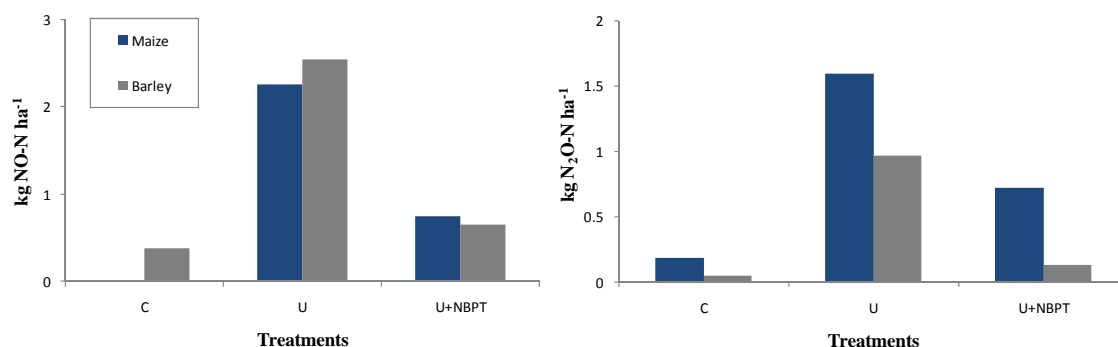

Figure 1. Cumulative losses of NO-N and N₂O-N at the end of the barley and the two maize crops.

4. Conclusion

The mitigating effect of NBPT was seen when nitrification was the dominant process in the production of N₂O. Since NO is mostly produced through nitrification under these conditions, using NBPT was also effective in the abatement of this reactive N gas.

References

- Ding, W.X., Yu, H.Y. and Zucong, C. C. 2011. Impact of urease and nitrification inhibitors on nitrous oxide emissions from fluvo-aquic soil in the North China Plain. *Biology and Fertility of Soils* 47, 91-99.
- Harrison, R. and Webb, J. 2001. A review of the effect of N fertilizer type on gaseous emissions. *Advances in Agronomy* 73, 65-108.
- Sanchez-Martin, L., Vallejo, A., Dick, J. and Skiba, U.M. 2008. The influence of soluble carbon and fertilizer nitrogen on nitric oxide and nitrous oxide emissions from two contrasting agricultural soils. *Soil Biology and Biochemistry* 40, 142-151.
- Sanz-Cobena, A., Misselbrook, T.H., Arce, A., Mingot, J.I., Diez, J.A. and Vallejo, A. 2008. An inhibitor of urease activity effectively reduces ammonia emissions from soil treated with urea under Mediterranean conditions. *Agriculture Ecosystems and Environment* 126, 243-249.
- Soil Survey Staff, 1992. *Keys to Soil Taxonomy*, sixth edition. USDA, Washington DC.
- Zaman, M., Saggar, S., Blennerhassett, J.D. and Singh, J. 2009. Effect of urease and nitrification inhibitors on N transformation, gaseous emissions of ammonia and nitrous oxide, pasture yield and N uptake in grazed pasture system. *Soil Biology and Biochemistry* 41, 1270-1280.

Can arbuscular mycorrhizal fungi enhance plant nitrogen capture from organic matter added to soil?

Saia, S.^a, Ruisi, P.^a, García-Garrido, J.M.^b, Benítez E.^c, Amato, G.^a, Giambalvo, D.^a

^aDipartimento dei Sistemi Agro-Ambientali, Università degli Studi di Palermo, Palermo, Italy

^bDepartamento de Microbiología, Estación Experimental de Zaidín, CSIC, Granada, Spain

^cDepartamento de Protección Ambiental, Estación Experimental de Zaidín, CSIC, Granada, Spain

1. Background & Objectives

Several studies have shown that arbuscular mycorrhizal (AM) fungi are involved in plant nitrogen (N) uptake from inorganic sources. In addition, the AM fungi may be important in plant N capture from decomposing organic matter (OM), but their role is still unclear (Hodge et al., 2010). The present work tested the hypothesis that AM symbiosis can affect durum wheat (*Triticum durum*) N acquisition from OM added to soil, either by directly or indirectly influencing OM decomposition.

2. Materials & Methods

A pot experiment was conducted in a climate-controlled glasshouse (25/19°C day/night temperature; 16 h photoperiod). A complete randomized factorial design with four replicates was adopted. Treatments were: i) AM symbiosis, inoculation of soil with *Glomus mosseae* (+Myc) and uninoculated control (–Myc); ii) organic matter (OM), soil amended with 4.6 g ¹⁵N-enriched maize leaves (C:N ratio 22.6:1) per kg of soil (+OM) and unamended soil (–OM). Each pot was filled with 600 g of a quartz sand:soil mixture (2:1). Soil properties were: clay 20% and sand 37%; pH 8.1 (soil:water 1:2); 1.04% organic C; 1.05% total N. The soil mixture was steam-sterilised. Before starting the experiment, a soil filtrate was inoculated to normalise the microbial community. Three wheat plants (cv Simeto) per pot were grown. During the experiment, each pot received 5 ml of a modified Hoagland's solution (with no phosphorus and 10% N) once every 5 days. The dry weights of wheat shoots and roots were recorded 9 weeks after the emergence of the crop and both fractions were analyzed for total N and ¹⁵N enrichment using an elemental analyzer–isotope ratio mass spectrometer. The activity of two soil proteolytic enzymes was measured: caseinase (a measure of the protein hydrolysis to mono-peptides) and BAA-protease (a measure of amino acid deamination). Wheat roots were stained with 0.05% trypan blue in lactic acid and AM infection was measured using the grid intersect method (Giovannetti and Mosse, 1980). The recovery of the applied ¹⁵N in wheat was calculated according to Allen et al. (2004). An analysis of variance was performed according to the experimental design.

3. Results & Discussion

No AM root infection was found in the –Myc treatment. The addition of OM to soil markedly decreased both plant growth and total N uptake and, at the same time, increased the caseinase and BAA-protease activities (Table 1), which suggests an increase in soil microbial activity. Because soil microorganisms outcompete plants for nutrients over short timescales, the depressive effect of OM on plant growth and N uptake may have been caused by the higher sequestration of available inorganic N and other nutrients by microorganisms in +OM. On average, mycorrhizal wheat yielded 20% more biomass and 15% more N than non-mycorrhizal control. Several studies have shown that AM symbiosis improves plant growth and nutrient uptake especially when plants are grown under nutrient-limiting conditions (Azcón et al., 2001). Through AM fungi, plants can better scavenge the soil volume, which enhance their ability to absorb the available N. In addition, as suggested by Hodge et al. (2000), AM fungi could enhance N uptake by host plant being more effective than non-mycorrhizal roots in competing with soil microorganisms for inorganic N. The microbial activity

(both caseinase and BAA-protease) was significantly higher in +Myc than –Myc in either +OM and –OM treatments. This should have involved an increase in soil N availability from OM. However, the ^{15}N recovery fraction from the added OM was markedly lower in +Myc than –Myc treatment. Two mechanisms can be invoked to explain such result: firstly, AM fungi could have acquired N from decomposing OM in the form of amino acids and retained this element primarily for their own growth and metabolism (Hodge and Fitter, 2010). Secondly, mycorrhizal plants are more effective than non-mycorrhizal plants to take up inorganic N; this probably limited N availability in soil, thus forcing soil bacteria to rely on organic compounds for satisfying their N demand, which limited the release of N from OM (Schimel and Bennett, 2004).

Table 1. Effects of AM symbiosis (AMS) on total plant biomass, total plant N uptake, ^{15}N recovery fraction from added organic matter (OM), AM root infection, and caseinase activity and BAA-protease activity in wheat grown in soil amended with OM (+OM) or without OM (–OM).

Organic matter (OM)	AM symbiosis (AMS)	Total plant biomass [g per pot]	Total plant N uptake [mg per pot]	^{15}N recovery fraction from added OM [%]	AM root infection ^{a)} [%]	Caseinase activity [$\mu\text{g Tyr g}^{-1} \text{h}^{-1}$]	BAA-protease activity [$\mu\text{g NH}_4^+ \text{g}^{-1} \text{h}^{-1}$]
–OM	–Myc	1.00	9.78	–	–	1.026	1.887
	+Myc	1.13	10.96	–	32.8	1.235	2.510
+OM	–Myc	0.79	7.68	6.36	–	1.328	2.114
	+Myc	1.01	9.03	3.93	35.1	1.609	3.323
F test ^{b)}	OM	**	**	–	***	*	***
	AMS	***	*	***	–	*	***
	OM \times AMS	ns	ns	–	–	ns	*

^{a)} not applicable to –Myc treatments;

^{b)} ns = not significant, *, ** and *** significant for $P < 0.05$, 0.01 and 0.001, respectively.

4. Conclusion

Although AM fungi increased soil N mineralization rates and total plant N uptake, they strongly reduced wheat N recovery from OM. This suggests that AM fungi have marked effects on competition between plants and bacteria for the different sources of N in soil.

References

- Allen S.C., Jose S., Nair P.K.R., Brecke B.J. and Ramsey C.L. 2004. Competition for ^{15}N -labeled fertilizer in a pecan (*Carya illinoensis* K Koch)-cotton (*Gossypium hirsutum* L) alley cropping system in the southern United States. *Plant and Soil* 263, 151-164.
- Azcón R., Ruiz-Lozano J.M. and Rodríguez R. 2001. Differential contribution of arbuscular mycorrhizal fungi to plant nitrate uptake (^{15}N) under increasing N supply to the soil. *Canadian Journal of Botany* 79, 1175-1180.
- Giovannetti M. and Mosse B. 1980. An evaluation of techniques for measuring vesicular-arbuscular mycorrhizal infection roots. *New Phytologist* 84, 489-500.
- Hodge A. and Fitter A.H. 2010. Substantial nitrogen acquisition by arbuscular mycorrhizal fungi from organic material has implications for N cycling. *Proceedings of the National Academy of Sciences, USA*, 107, 13754-13759.
- Hodge A., Helgason T. and Fitter A.H. 2010. Nutritional ecology of arbuscular mycorrhizal fungi. *Fungal Ecology* 3, 267-273.
- Hodge A., Robinson D. and Fitter A.H. 2000. Are microorganisms more effective than plants at competing for nitrogen? *Trends in Plant Science* 5, 304-308.
- Schimel J.P. and Bennett J. 2004. Nitrogen mineralization: Challenges of a changing paradigm. *Ecology* 85, 591-602.

Canola response to N fertilization as affected by preceding crop and location

Grant, C.A., Gao, X., O'Donovan, J.T., Zebarth, B., Blackshaw, R.E., Harker, K.N., Lafond, G.P., Johnson, E.N., Gan, Y.

Agriculture and Agri-Food Canada Research Centres, Brandon, Lacombe, Fredericton, Lethbridge, Indian Head, Scott and Swift Current, Canada

1. Background & Objectives

Excess N application is a major cause of poor N use efficiency (NUE), contributing to negative environmental impacts and reduced economic benefit. Soil nitrate is used in western Canada to predict soil N supply and N fertilizer recommendations, but its effectiveness may have decreased due to changing crop production practices. Higher yielding cultivars, reduced tillage, cropping intensification, and higher fertilizer input over time may have increased the return of high N crop residues to the soil and increased the contribution of in-season N mineralization to the crop N supply (Grant et al., 2002). A more accurate estimate of the total supply of both inorganic and mineralizable N is needed to predict N requirements and avoid over- or under-fertilization.

2. Materials & Methods

Field studies were conducted at 6 sites across western Canada to assess effects of preceding crop, soil characteristics and environment on yield response of canola to N fertilization and to evaluate the effectiveness of various soil tests and modelling approaches in predicting optimum N fertilization rate. The study consisted of a two year crop sequence with preceding crops (fababean grown for seed, fababean used as green manure, and pea, lentil, wheat and canola grown for seed) grown in the first year and canola grown in the second year. Nitrogen fertilizer was applied to the canola as urea, banded at the time of seeding at 0, 30, 60, 90 and 120 kg N ha⁻¹. Soil samples were taken after the growth of the preceding crop but before seeding of the canola and analysed for nitrate, ammonium and for mineralizable N using several techniques. A split-plot design with four replicates was used with preceding crop as the main plot and N rates as sub-plots. Crops were harvested at maturity and analyzed for seed and tissue N. The ability of the various soil tests to predict plant-available N and the yield response to N application is currently being assessed.

3. Results & Discussion

Total soil nitrate-N in the upper 60 cm was highest after fababean green manure in half of the sites, but soil nitrate-N was not consistently higher after pulse crops than after canola or wheat (Table 1).

Table 1. Total nitrate-N (kg ha⁻¹ to 60 cm) as affected by preceding crops at six locations across western Canada.

	<u>Beaverlodge</u>	<u>Brandon</u>	<u>Indian Head</u>	<u>Lacombe</u>	<u>Scott</u>	<u>Swift Current</u>	<u>Mean</u>
Fababean							
(green manure)	45.3	73.4	27.8	55.3	75.8	57.4	55.8
Field peas	20.6	65.4	27.2	40.1	26.4	59.3	39.8
Fababeans	16.9	63.9	8.3	31.9	26.0	49.3	36.3
Lentils	16.5	73.7	26.9	34.8	21.2	58.5	35.7
Canola	19.0	54.8	10.4	24.5	23.0	38.3	33.5
Wheat	24.9	72.8	14.2	23.0	27.5	46.8	31.6
LSD (0.05)	6.2	13.9	6.3	8.8	38.4	15.8	

Total canola seed yield and the yield increase with N application varied substantially with location and preceding crop (Figure 1). Seed yield was consistently higher after fababean green manure than wheat or canola, regardless of N fertilizer input or effect on soil nitrate, indicating both a nitrate-

based and a non-nitrate-based benefit. Seed yield of canola and the yield response to N application was related to soil nitrate-N concentration to some extent, but there were discrepancies. For example, soil nitrate-N at Beaverlodge and Lacombe was low compared to that at Brandon, yet the canola seed yield was as high or higher in the unfertilized check and response to fertilizer application lower at these two sites than at Brandon. This may indicate high levels of mineralizable N at the Beaverlodge and Lacombe sites. Several mineralization tests are currently being evaluated for their ability to more accurately predict plant-available N and potential response to N fertilization at these field locations.

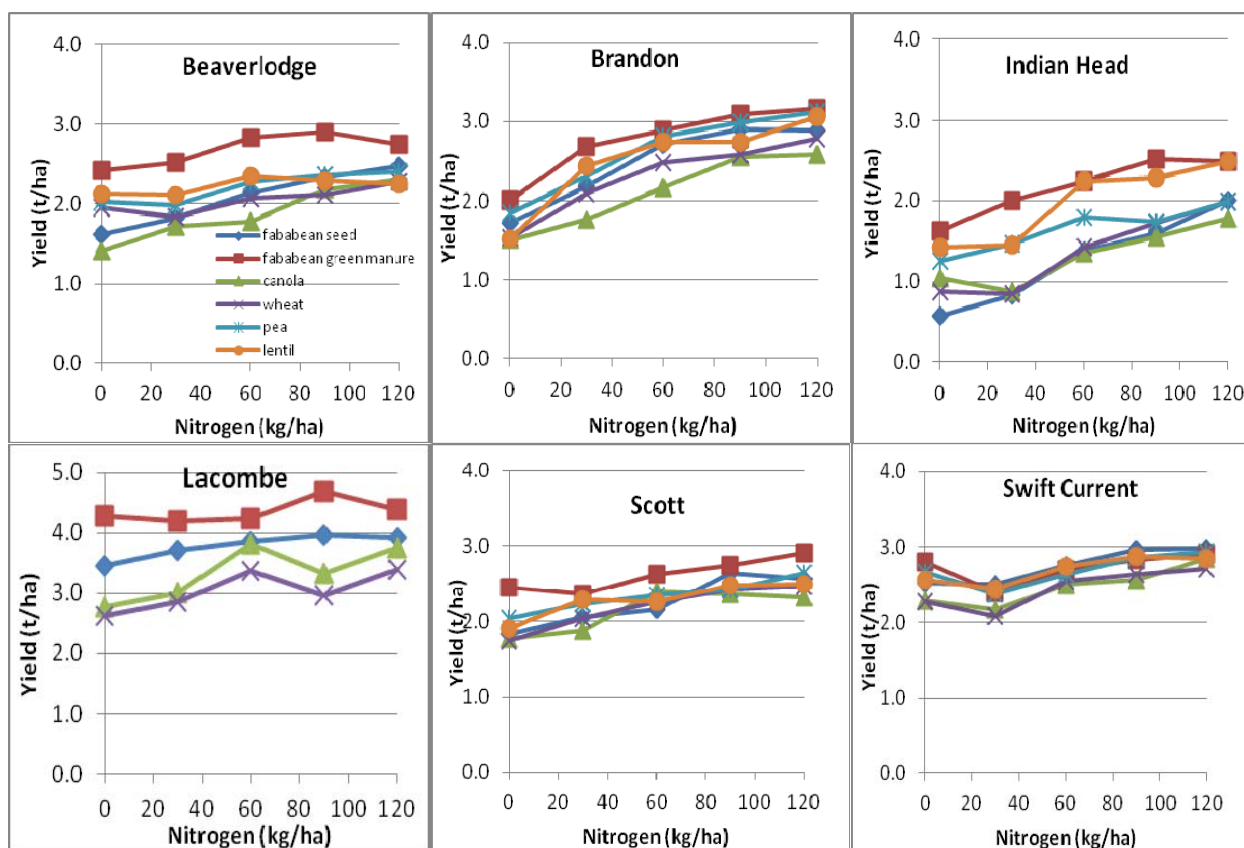

Figure 1. Yield response as a function of nitrogen fertilization and preceding crop at six locations in western Canada.

4. Conclusion

Fababean green manure provided both nitrogen and non-nitrogen benefits to the following canola crop. Soil nitrate-N provided an approximate indication of plant-available N and yield response to N application, but better prediction is needed to more accurately determine fertilizer N requirements.

References

Grant, C.A., Peterson, G.A. and Campbell, C.A., 2002. Nutrient considerations for diversified cropping systems in the Northern Great Plains. *Agronomy Journal* 94, 186-198.

Carbon and nitrogen residual effects after repeated manure applications

Bechini, L.^a, Cavalli, D.^a, Marino, P.^a

^aDepartment of Plant Production, Università degli Studi di Milano, Milano, Italy

1. Background & Objectives

Repeated applications of animal manure to agricultural soils contribute to the short term fertility (Bechini and Marino, 2009), but determine also the residual effect, i.e. higher crop N availability in manured compared to unmanured soils, through the mineralisation of recalcitrant manure components and the re-mineralisation of microbially-immobilised N (Sørensen, 2004). Manure residual effect has been studied in several field experiments (e.g. Schröder et al., 2007). Compared to field experiments, a laboratory incubation permits the measurement of the net N mineralisation of manures, without the confounding effect of other N inputs or outputs. It also enables the fate of added N in different compartments to be traced (e.g. Sørensen, 1998; Van Kessel and Reeves, 2002). The aim of this laboratory experiment was to estimate under constant soil temperature and water content the residual effect of C and N after repeated applications of dairy cow manure to a clay-loam soil.

2. Materials & Methods

A liquid dairy cow manure (dry matter 8.2%; organic C 34.9 g C kg⁻¹; total N 3.9 g N kg⁻¹; NH₄-N 1.9 g N kg⁻¹; pH 8.0) was applied to a clay-loam soil (sand 45%; silt 25%; clay 30%; organic C 1.16%; total N 0.14%; pH 6.8). Manure-amended soil (MAN) and unamended soil (CON) were incubated. We adopted a fully randomised experimental design with three replicates and we followed the “nursery” method by Thuriès et al. (2000). In order to provide enough experimental units (mix of soil + manure or water) for a total of 35 destructive measurements over time, we set up 210 experimental units (2 treatments × 4 manure applications × 3 replicates × 35 sampling dates). Each experimental unit contained an amount of preincubated soil corresponding to 100 g dry soil. Preincubation was carried out for 1-week to allow mineralisation of labile pools present in the soil after air desiccation, sieving (at 2 mm) and remoistening. Experimental units were divided in four groups; the first group received manure once, the second group twice, the third three times, and the last group four times. Repeated applications were made every 85 days at a rate of 100 mg N kg⁻¹ soil (corresponding to 360 kg N ha⁻¹, considering a plough depth of 0.3 m and a soil bulk density of 1.2 g cm⁻³) for each addition. After the last manure application, 3 replicates of MAN and CON were analyzed for respired C and soil mineral N concentration on Day 0, 1, 7, 15, 29, 41 and 85; in addition, experimental units receiving 1 and 4 manure applications, were analyzed on Day 21 and, only experimental units receiving manure once, were analyzed on Day 10.

The incubation was carried out at a soil water potential of -50 kPa, and a temperature of 25°C. Experimental units were periodically watered to compensate for water loss by evaporation.

Measurements of respired C were carried out by the alkali trap method (Stotzky, 1965) while concentrations of 1M KCl extractable ammonium and nitrate were determined by flow injection analysis and spectrometric detection. For each incubation interval, the net respiration of manure C was determined by subtracting the CO₂-C of CON from that of MAN (assuming no priming effect from the manure). These values were summed for all the intervals to obtain the accumulated respiration. For each incubation interval net soil mineral nitrogen concentration (SMN = NH₄-N + NO₃-N) was calculated as the SMN in MAN minus the SMN in CON. Manure C residual effect (CRE) due to one, two or three manure applications was calculated as the difference between the net accumulated CO₂-C at day 85 measured during application 4 and the net accumulated CO₂-C

measured at day 85 during applications 3, 2 or 1. We hypothesised that increments in the respiration of manure C after repeated applications could be ascribed to the mineralisation of the recalcitrant components of the manure applied to the soil. Manure N residual effect (NRE) due to one, two or three manure applications was calculated as the difference between the net SMN at day 85 measured during application 4 and the net SMN measured at day 85 during applications 3, 2 or 1.

3. Results & Discussion

The percentage of respired manure C increased after repeated manure applications. The accumulated CO₂-C respired corresponded to 47, 51, 52 and 55% of manure C 85 days after 1, 2, 3 and 4 applications, respectively. Estimated carbon residual effects of one, two or three manure applications were 3, 4 and 7% of manure C respectively (Figure 1a).

Similarly, SMN concentration increased after two, three and four manure applications (+1, +9, +9%) compared to a single manure application (Figure 1b).

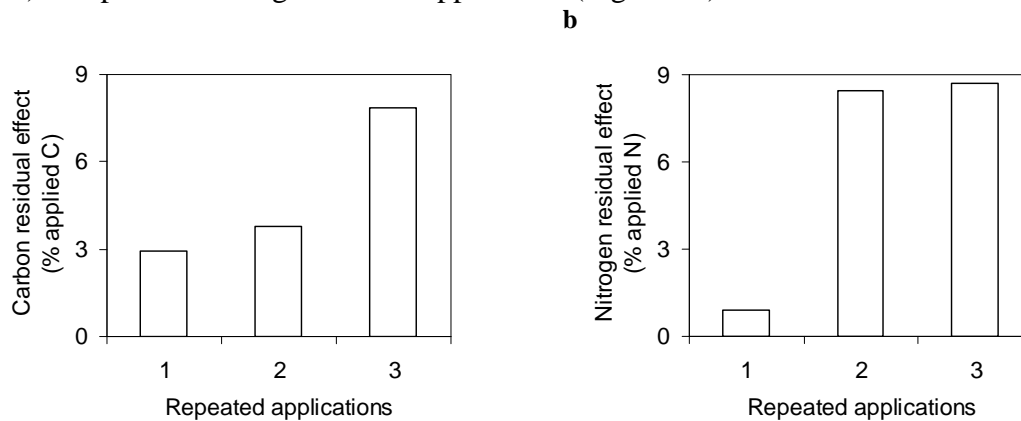

Figure 1. Carbon (a) and nitrogen (b) residual effects of a liquid dairy cow manure applied to a clay-loam soil.

4. Conclusions

These preliminary results show that after repeated manure applications of liquid dairy manure to a clay-loam soil, part of the added organic matter is slowly mineralised, contributing to a progressive release of ammonium into the soil. The results of these incubation studies are useful to better understand the residual effect of carbon and nitrogen in the field and to improve simulation models.

References

- Bechini, L. and Marino, P. 2009. Short-term nitrogen fertilizing value of liquid dairy manures is mainly due to ammonium. *Soil Sci. Soc. Am. J.* 73, 2159-2169.
- Schröder, J., Uenk, D. and Hilhorst, G. 2007. Long-term nitrogen fertilizer replacement value of cattle manures applied to cut grassland. *Plant and Soil* 299, 83-99.
- Sørensen, P. 1998. Effects of storage time and straw content of cattle slurry on the mineralization of nitrogen and carbon in soil. *Biol. Fert. Soils* 27, 85-91.
- Sørensen, P. 2004. Immobilisation, remineralisation and residual effects in subsequent crops of dairy cattle slurry nitrogen compared to mineral fertiliser nitrogen. *Plant and Soil* 267, 285-296.
- Stotzky, G. 1965. Microbial respiration, In C.A. Black et al. (ed.) *Methods of soil analysis*. Agron. Monogr. 9. ASA, Madison, WI pp. 1150-1572.
- Thuriès, L., Larrè-Larrouy, M.C. and Pansu, M. 2000. Evaluation of three incubation designs for mineralization kinetics of organic materials in soil. *Comm. Soil Sci. Plant Anal.* 31, 289-304.
- Van Kessel, J.S., Reeves III, J.B. and Meisinger, J.J. 2000. Nitrogen and carbon mineralization of potential manure Components. *J. Environ. Qual* 29, 1669-1677.

Comparing N recovery from legumes grown as green manures in olive orchards

Arrobas, M.^a, Ferreira, I.Q.^a, Claro, M.^a, Correia, C.M.^b, Moutinho-Pereira, J.M.^b, Bacelar, E.^b, Fernandes-Silva, A.A.^b, Rodrigues, M.A.^a

^aCIMO – Mountain Research Centre, Polytechnic Institute of Bragança, Portugal

^bCITAB – Centre for the Research and Technology of Agro-Environmental and Biological Sciences, UTAD, Portugal

1. Background & Objectives

Green manuring is probably the only option for extending on a great scale the acreage of organic farming in the perennial crops of the Mediterranean basin such as olive groves. Olive growers, in general, do not have animals so the availability of organic manures is not sufficient to maintain soil fertility. In addition, the organic composts approved for organic farming on the market have high prices and are sometimes speculative, in relation to their fertiliser value (Rodrigues et al., 2006). In NE Portugal there is a long tradition in the cultivation of white lupin (*Lupinus albus*) as a means of improving soil fertility. However, little is known about the dry matter yield and N fixation potential of lupin in these agrosystems, and also of the transfer of fixed N to the trees. In this work the results of dry matter yield and N recovery by lupin, vetch (*Vicia villosa*) and a mixture of self-reseeding annual legumes are presented. The trial also included plots of oats (*Avena sativa*) and natural vegetation.

2. Materials & Methods

Two field trials were carried out on Carrascal farm (Vila Flor) and Suçães (Mirandela) in NE Portugal. On Carrascal farm the treatments of the experimental design were: white lupin, vetch, a mixture of self-reseeding annual legumes, oats and natural vegetation as control. The species/varieties of the mixture were: *Ornithopus compressus* cv. Charano, *Ornithopus sativus* cvs. Erica and Margurita, *Trifolium subterraneum* cvs. Dalkeith, Seaton Park, Denmark and Nungarin, *Trifolium resupinatum* cv. Prolific, *Trifolium incarnatum* cv. Contea, *Trifolium michelianum* cv. Frontier and *Biserrula pelecinus* cv. Mauro. On Suçães, the treatments were: white lupin, the same mixture of self-reseeding annual legumes, oats and natural vegetation fertilised with N (60 kg N ha⁻¹) and not fertilised. Dry matter yield and N recovery were determined from field samples of the above-ground biomass. Nitrogen concentration in plant tissues was determined by a Kjeldahl procedure.

3. Results & Discussion

White lupin produced 6.9 and 8.2 Mg DM ha⁻¹ and accumulated 138 and 195 kg N ha⁻¹ in the above-ground biomass at Carrascal and Suçães, respectively (Figures 1 and 2). The values may be considered high if compared with others reported in the literature (Carranca et al., 2009). In Carrascal, vetch showed slightly lower DM yield than white lupin, but its tissues presented higher N concentration. As a result, N recovered was slightly higher in vetch (156 kg N ha⁻¹) in comparison to lupin. Annual legumes produced 5.6 and 6.4 Mg DM ha⁻¹ and recovered 105 and 110 kg N ha⁻¹. Oats showed fair DM yields (4.7 and 3.0 Mg ha⁻¹), but N concentrations in tissues were very low (5.4 and 5.2 g kg⁻¹), recovering only 25.6 and 15.7 kg N ha⁻¹. The dry matter yields recorded from the natural vegetation not fertilized were low (1.1 and 0.7 Mg ha⁻¹) and N recoveries very low (11 and 7 kg N ha⁻¹), revealing that these soils presented very low levels of N availability. Applying N, only a small increase in DM yield was found (1.1 Mg N ha⁻¹), but N concentration in tissues increased markedly (20.8 g kg⁻¹). The reduced stimulus in DM yield of natural vegetation by N application in spring is explained by reduced nitrophily, a short growing season, and the small size

of several dominant species in the infertile soils where the orchards are established, such as *Mibora minima*, *Crassula tillaea* and *Spergula arvensis* (Rodrigues et al., 2009).

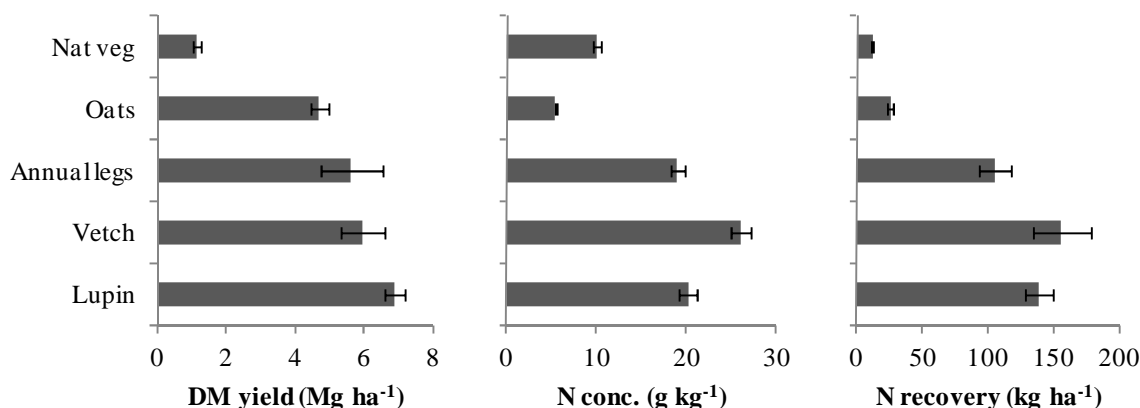

Figure 1. Dry matter yield, N concentration and N recovery in above-ground biomass in Carrascal farm, Vila Flor.

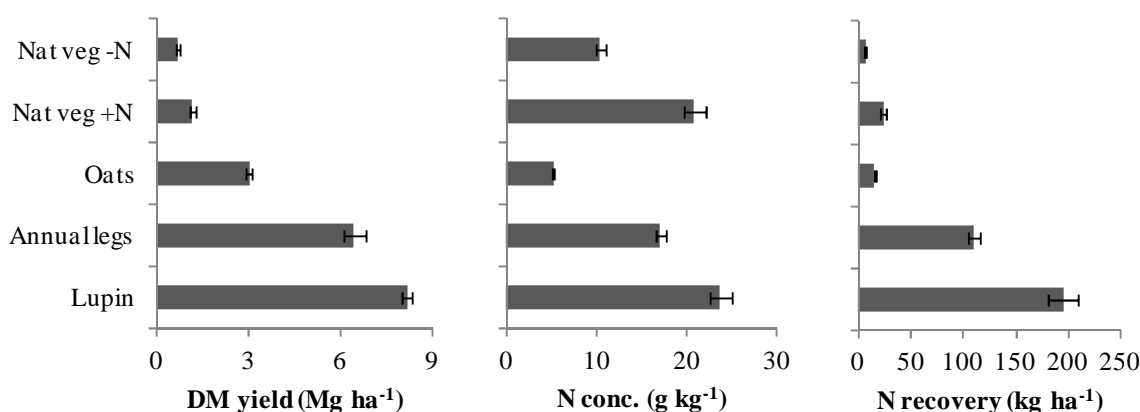

Figure 2. Dry matter yield, N concentration and N recovery in above-ground biomass in Suções, Mirandela.

4. Conclusion

The legume species included in these experiments were particularly well adapted to the agroecological conditions of the region. They showed high potential for DM yield and N fixation in soils with very low natural fertility. White lupin and vetch might accumulate more than 150 kg N ha⁻¹ yr⁻¹, values that seem high enough to ensure the N nutrition of the trees without additional fertilisers. However, further studies are necessary to evaluate the efficiency of N transfer to the trees.

Acknowledgement Funded by FCT (Portugal) through the project PTDC/AGR-AAM/098326/2008.

References

- Rodrigues, M.A., Pereira, A., Cabanas, J. E., Dias, L. Pires, J. and Arrobas, M. 2006. Crops use-efficiency of nitrogen from manures permitted in organic farming. *European Journal of Agronomy* 25, 328-335.
- Rodrigues, M.A., Cabanas, J.E., Lopes, J.I., Pavão, F., Aguiar, C. and Arrobas, M. 2009. Grau de cobertura do solo e dinâmica da vegetação em olivais de sequeiro com a introdução de herbicidas. *Ver. Ciências Agrárias XXXII*, 30-42.
- Carranca, C., Torres, M.O. and Baeta, J. 2009. White lupine as a beneficial crop in Southern Europe. I. Potential for N mineralization in lupine amended soil and yield and N₂ fixation by white lupine. *Europ. J. Agron.* 31, 183-189.

Comparing strategies for implementing soil organic matter and nitrogen use in two contrasting soils

Fiorentino N.^a, Bertora C.^b, Alluvione F.^b, Zavattaro L.^b, Fagnano M.^a, Quaglietta Chiarandà F.^a, Grignani C.^b

^aDepartment of Agricultural Engineering and Agronomy, University of Naples Federico II, Italy

^bDepartment of Agronomy, Forest, and Land Management, University of Turin, Italy

1. Background & Objectives

In the last decades, wide scientific debate has highlighted the need to preserve and restore soil organic matter and to improve soil ecosystemic functions. A field experiment was designed to assess the applicability of alternative C sequestration strategies: either adoption of minimum tillage or addition of stabilized organic matter in the form of compost. Strategy success was evaluated by the ability of each tool to effectively enhance soil organic carbon (SOC) and support maize yield.

2. Materials & Methods

Tested treatment were compost distribution (COM) or minimum tillage (MT) compared to conventional management (CONV), under contrasting soil conditions (high fertility-coarse texture at Turin site – NW Italy- and low fertility-fine texture at Naples site- southern Italy). Field trials lasted from 2006 to 2008. N input was 130 kg N ha⁻¹ for all the treatments except a non-N-fertilized ploughed control (0N). N sources were urban waste compost (COM) and urea (MT, CONV). Treatment effect was evaluated through yield and medium-term variation of soil fertility, as indicated by SOC and total N. Variables were analysed through ANOVA considering the treatment as the main factor; for yield, year effect was analysed as a repeated measure. Site was not included as factor in order to preserve homogeneity of variance (sites were analysed separately).

3. Results & Discussion

Soil properties influenced the different maize responses to treatments between the two study sites. Naples was characterized by a lower fertility than Turin, which resulted in a marked reduction of COM agronomic performance with respect to CONV in all years. Different results occurred at Turin, where its higher fertility buffered any treatment effect (Table 1). It is likely that compost released a fraction of its organic N after soil incorporation where it acted as a slow-release fertilizer (Erhart et al., 2007), with labile N representing a small portion of total N. Thus, complete substitution of mineral fertilizers with compost is usually possible in coarse but fertile soils, while higher amounts of total N with respect to mineral fertilizers are needed in fine-textured low-fertile soils (Fagnano et al., 2011). Lower initial soil fertility at Naples resulted in higher soil C sequestration (Figure 1); even though maize yield was lower. Reduction of tillage intensity was effective in sequestering C in the Naples clayey soil, likely because maize root mineralization was mitigated by anoxic conditions, while coarse textured soil at Turin always favoured crop residue oxidation. Still it is possible that C sequestration at Turin could occur in the medium- to long-term. Results suggested that SOC preservation could be agronomically sustainable in the fine-textured soils near Naples only with MT. In fact SOC increased with either using compost or MT, but compost strongly reduced maize yield since anoxic soil conditions hindered organic matter mineralization and favoured plant-available N immobilization. SOC preservation in the fertile and coarse-textured soils near Turin was achieved only with compost addition (55.1 % of added C), probably because soil aeration fostered root oxidation in MT.

Table 1. Total biomass and N uptake of the different treatments at Naples and Turin during the three years of treatment application (2006 to 2008).

		Naples			Turin		
		2006	2007	2008	2006	2007	2008
Total biomass [Mg d.m. ha ⁻¹]	CONV	21.9	18.7	15.5	25.4	23.9	19.4
	MT	22.0	20.2	16.9	21.9	24.4	19.7
	COM	7.0	6.7	6.8	23.6	23.8	16.4
	ON	21.5	9.3	11.4	28.4	21.1	13.1
Effects		P(F)	LSD(Sidak)		P(F)	LSD(Sidak)	
	Treatment	0.000	-		n.s.	-	
	Year	0.000	-		0.000	-	
	Interaction	0.000	5.3		0.000	3.9	
N uptake [kg N ha ⁻¹]	CONV	253.3	186.0	115.6	287.1	222.4	197.9
	MT	243.0	183.9	127.2	257.1	250.1	186.0
	COM	42.7	40.6	46.7	246.9	220.0	140.6
	ON	178.0	57.5	81.8	292.0	177.2	113.9
Effects		P(F)	LSD(Sidak)		P(F)	LSD(Sidak)	
	Treatment	0.000	-		n.s.	-	
	Year	0.000	-		0.000	-	
	Interaction	0.000	53.3		0.000	57.0	

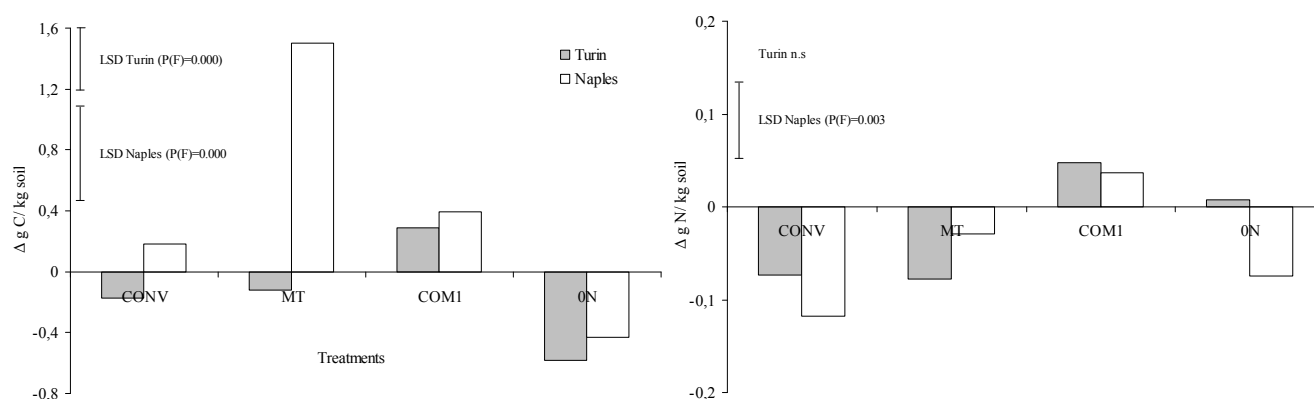

Figure 1. Soil organic C and total N concentration variations of the different treatments at Naples and Turin at the end of treatment application (harvest in 2008) relative to pre-treatment conditions (pre-fertilization in 2006).

4. Conclusion

The minimum tillage can substitute conventional management. Application of a stable organic matter such as compost is valuable in fertile, aerated soils, but should be avoided in low fertility, anoxic soils as crop yields can be depleted. Preservation of organic matter oxidation through minimum tillage maintained crop production both in fertile and non-fertile soils, but its fit is better in anoxic soils where SOC sequestration is higher. Our findings confirm that there is no unique solution to environmental issues, but a series of options that need to be evaluated in the specific pedo-climatic and farming system conditions.

References

- Erhart, E., Hartl, W. and Putz, B. 2005. Biowaste compost affects yield, nitrogen supply during the vegetation period and crop quality of agricultural crops. *European Journal of Agronomy* 23, 305-314.
- Fagnano, M., Adamo, P., Zampella, M. and Fiorentino, N. 2011. Environmental and agronomic impact of fertilization with composted organic fraction from municipal solid waste. *Agriculture Ecosystems & Environment* 141, 100-107.
- Lal, R. 2004. Agricultural activities and the global carbon cycle. *Nutrient Cycling in Agroecosystems* 70, 103-116.

Comparison of APSIM and DNDC for simulating nitrogen transformation and N₂O emissions from urine patches

Vogeler, I.^a, Cichota, R.^a, Giltrap, D.^b, Snow, V.^c

^aAgResearch, Grasslands Research Centre, Palmerston North, New Zealand

^bLandcare Research, Palmerston North, New Zealand

^cAgResearch, Lincoln Research Centre, Lincoln, New Zealand

1. Background & Objectives

Nitrogen transformation rates and nitrous oxide (N₂O) emissions from urine patches are notoriously variable, both in space and time, due to the variability of controlling environmental factors. Thus annual N₂O losses are often made up by a few emission peaks. Effective mitigation of N₂O emissions from pastoral systems requires better understanding of the factors that control the interconnected N cycling processes, including nitrification, denitrification and gaseous emissions.

Computer simulation models provide a cost effective method of estimating N₂O emissions from soils and for evaluating how heterogeneity in climate and soil affect these emissions. Various simulation approaches are in use or being developed to predict N₂O emissions. The models vary in the level of detail or number of nitrogen pools and transformation processes considered, as well as on how the processes are described. Other processes within the models, such as water and heat transport within the soil also affect the modelled N transformations and losses. And while most models have been tested and validated for certain aspects, there is a lack of information on how models compare in other aspects. The objective of this paper is to compare the APSIM (Agricultural Production Systems Simulator; (Keating et al., 2003),) and DNDC (DeNitrification DeComposition; (Li et al., 1992)) model for simulating N transformation processes and N₂O emissions from urine patches.

2. Materials & Methods

N transformations and N₂O emissions from urine patches from the two different simulation approaches, APSIM and DNDC, were compared by setting up simulations comprising two different regions of NZ, two different soils, 4 different N deposition times, (Spring, summer, autumn and winter), and four different N deposition loads (250, 500, 750, and 100 kg N/ha). The simulations were run for 3 months and simulation output included cumulative and daily values of nitrification, denitrification, volatilisation, and N₂O emissions. Simulation results were also compared to different datasets comprising N₂O emissions from urine patches.

3. Results & Discussion

Simulated N transformation rates as dependent on environmental conditions were quite different for the two models, APSIM and DNDC. APSIM simulated denitrification in a silt loam in the Waikato region of NZ increases nearly linear with increasing N load (Figure 1), whereas denitrification simulated by DNDC reaches a plateau at an N load of 250 kg ha⁻¹ and thereafter remains almost constant. DNDC also shows little seasonal affect to denitrification, whereas APSIM predicts much higher denitrification in autumn compared to summer and spring. This model difference is partly due to the higher sensitivity of denitrification in APSIM to soil water content, and of DNDC on soil temperature. Simulated N₂O emissions by APSIM show a similar trend to denitrification, whereas those simulated by DNDC show a linear increase over the entire range of N load simulated. This suggests that in DNDC at high N loads nitrification becomes a major source for N₂O emissions.

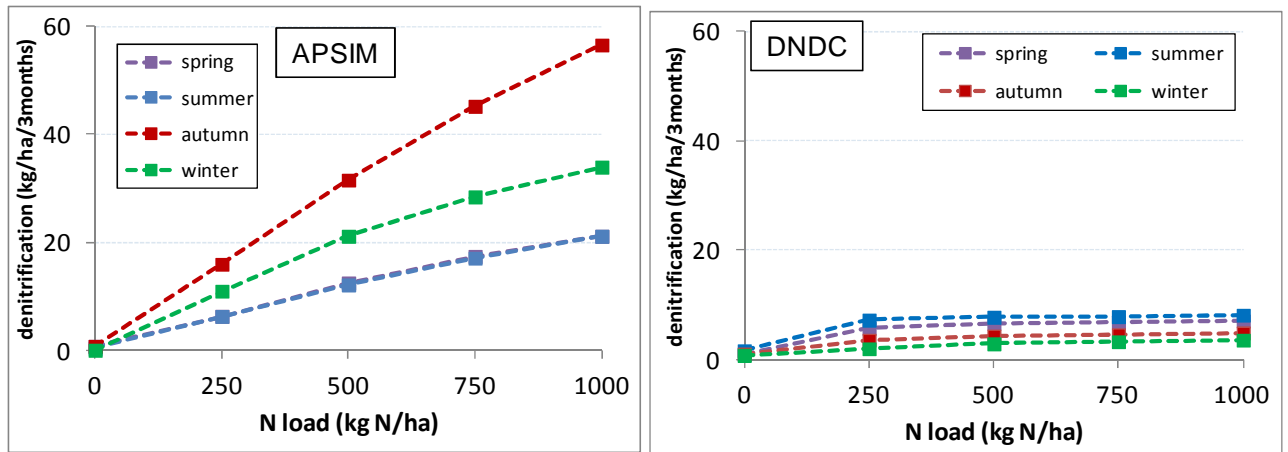

Figure 1. APSIM and DNDC simulated denitrification rate as dependent on N load and time of deposition in a silt loam in the Waikato region of NZ.

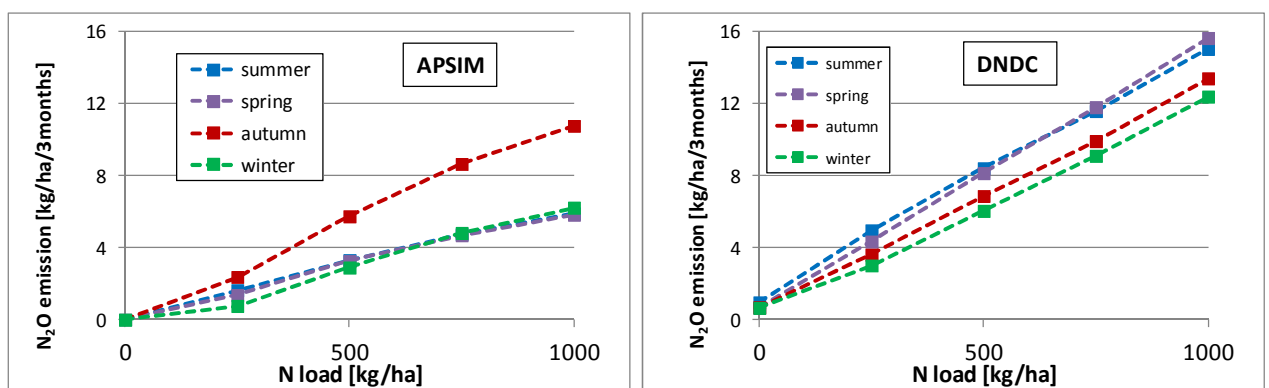

Figure 2. APSIM and DNDC simulated N₂O emission as dependent on N load and time of deposition in a silt loam in the Waikato region of NZ.

4. Conclusion

Simulated denitrification and N₂O emissions over 3 months for different N loads and seasons were quite different, indicating higher sensitivity of APSIM to soil water content, while DNDC shows a stronger influence of temperature, with denitrification triggered by rainfall. APSIM also shows a much higher seasonal variation in both denitrification and N₂O emissions, suggesting higher sensitivity of APSIM to environmental conditions compared with DNDC.

5. Acknowledgments

This project is jointly funded by the New Zealand Agricultural Green House Gas Research Centre (NZAGRC) under “Integrated Systems” and MAF under “Sustainable Land Management Mitigation & Adaptation to Climate Change”.

References

- Keating, B., et al. 2003, An overview of APSIM, a model designed for farming systems simulation: *European Journal of Agronomy* 18, 267-288.
- Li, C., Frolking, S. and Frolking, T.A., 1992, A model of nitrous oxide evolution from soil driven by rainfall events. Model structure and sensitivity.: *Journal of Geophysical Research* 9, 9776-9799.

Determination of denitrification capacity of small headwater catchments in Flanders.

Van Overtveld, K.^a, Tits, M.^b, Elsen, A.^b, Van De Vreken P.^a, Van Orshoven, J.^a, Vanderborght, J.^a, Diels, J.^a, Batelaan, O.^a

^aDepartment of Earth and Environmental Sciences, K.U. Leuven, Heverlee, Belgium.

^b Soil Service of Belgium, Heverlee, Belgium.

1. Background & Objectives

Pollution of surface water bodies with nitrates is a major problem in Flanders, Belgium. The nitrate (NO_3^-) concentration in many surface water bodies exceeds the maximum concentration of 50 mg $\text{NO}_3^- \text{L}^{-1}$ set in the EU Nitrates Directive (91/676/EEC). Although water quality is steadily improving, in 2010 still 28% of the surface water sampling points of the Manure Action Plan water quality network (MAP) exceeded the Nitrates Directive limit at least once a year (VMM, 2010). An important cause of this pollution is leaching from agricultural parcels due to intensive manure application and high nitrogen leftover in soils after harvest of the crops. Over the winter period nitrate largely leaches out of the root zone and may ultimately reach surface water bodies via tile drains or the aquifer. However, during transport through soil and groundwater, denitrification processes may occur, resulting in lower nitrate loading in surface water bodies. Knowledge about the fraction of nitrate that is thus denitrified in Flanders is scarce. Such knowledge is important for policy makers, since it could contribute to delineate zones that are more vulnerable to surface water pollution with nitrate. This way, efforts to improve water quality can be focussed on these regions. In this study the environmental variables controlling the denitrification capacity of small headwater catchments in Flanders are investigated and a regional differentiation of this denitrification capacity is defined.

2. Materials & Methods

For all 794 surface water sampling points of the MAP-network, each individual catchment area was delineated using the ArcSwat GIS-software (Neitsch et al., 2009). A subset of 50 sampling points and their corresponding catchments was selected for further analysis. Selection was based on homogeneity of each catchment regarding soil granulometrical class and hydrogeological properties. The selected catchments were not affected by pollution from residential sewage. For all parcels (agricultural and other land use types) within each catchment, the nitrate leached from the root zone was modelled for 4 subsequent years, by means of an analytical solution of the convection dispersion equation, and the mean nitrate concentration of the leachate below the 90 cm depth plane (rootable depth) for each catchment was calculated. The mean nitrate concentration in the surface water sampling points was calculated as the sum of the monthly measured concentrations, weighed by the ratio of monthly discharge over the total annual discharge. The ratio of area-averaged nitrate concentration of the leachate in each catchment over the weighted mean nitrate concentration in the corresponding surface water sampling point, is interpreted as the denitrification capacity per catchment. This ratio is defined as the *process factor* (PF) for nitrate (Herelixka et al., 2002). For low values of the process factor (between 1 and 1.5) almost no denitrification occurs. The larger the process factor, the more nitrate denitrification occurs.

3. Results & Discussion

Process factor values ranged from 0.9 to 104.4. The soil granulometrical class of the catchment and the redox potential of the underlying aquifer proved to be the main significantly explanatory variables of the process factor. A predictive regression model for the process factor was constructed with these two variables by means of a stepwise regression analysis. The original process factors (PF) were transformed with a Box-Cox transformation to get a set of normally distributed transformed process factors (PF_t):

$$\text{PF}_t = A + 0.001943 \times \text{redox potential (mV)} \quad (n = 47, R^2 = 0.39)$$

sand: $A = -1.270$

sandy loam: $A = -1.241$

silt: $A = -1.650$

clay: $A = -1.433$

PF_t is the Box-Cox transformed process factor ($\lambda = -0.5$):

$$PF_t = 2 \times \left(\frac{1}{\sqrt{PF}} - 1 \right)$$

Full-coverage predictions for the region of Flanders were made with this model, based on the digital soil map and a geodataset of the redox potential of the phreatic aquifer (DOV, 2011). In Figure 1, the predicted Process factor is visualized after retransformation of the PF_t to PF.

A clear regional variation of the process factor can be distinguished with values of 1.3 in the East (deep sandy soils with high redox potential) to 12 in the West (shallow estuarine clayey soils with low redox potential).

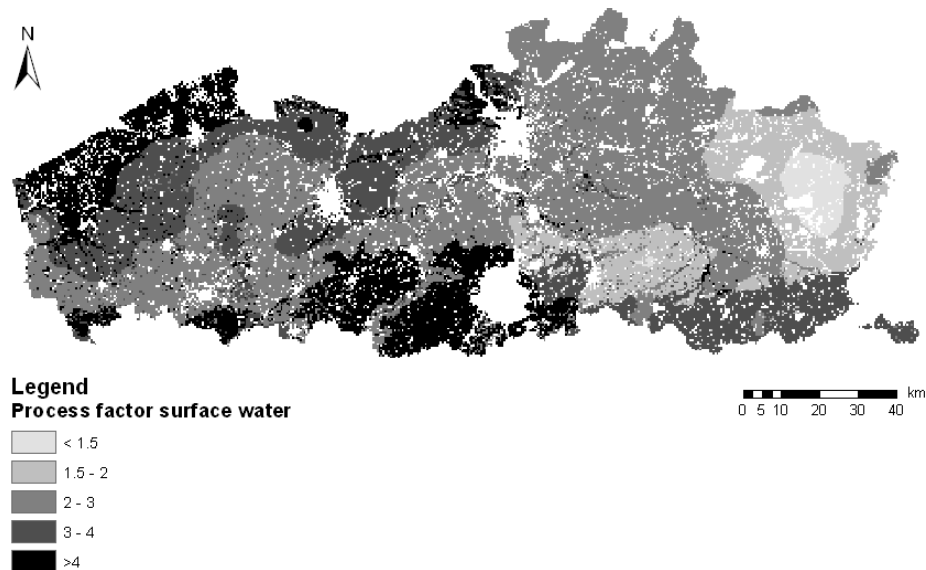

Figure 1. Predicted process factor for surface water in Flanders, Belgium. White zones correspond with residential areas or zones with no soil data.

4. Conclusion

This study investigated factors determining the denitrification capacity of small headwater catchments in Flanders. Results suggest that soil texture and redox potential of the aquifer are the main explanatory variables. A predictive model allowed for a regional differentiation of the denitrification capacity in Flanders. The resulting predictive map of the process factor could be used as a tool to evaluate the vulnerability of surface waters to nitrate pollution.

References

- DOV, 2011. Databank Ondergrond Vlaanderen, available at: <https://dov.vlaanderen.be/dov/DOVInternet/startup.jsp>
- Herelixka, E., Librecht, I., Oorts, K., D'Haene, K., Coppens, F., Vogels, N., Rombauts, S., Merckx, R., Vanongeval, L., Sammels, L., De Neve, S., Wellens, J., Verstraeten, W., Salomez, J., El Sadek, A., Boeckx, P., Geypens, M., Van Orshoven, J., Van Cleemput, O. and Feyen, J. 2002. Eindrapport van de onderzoeksopdracht "N-(eco)²: Bepaling van de hoeveelheid minerale stikstof in de bodem als beleidsinstrument (Besteknummer2000/1)". I.o.v. de Vlaamse Landmaatschappij, Afdeling Mestbank.
- Neitsch S. L., Arnold J. G., Kiniry J. R. and Williams J. R. 2009. Soil and Water Assessment Tool. Theoretical Documentation. Version 2009. Grassland, Soil and Water Research Laboratory, Blackland Research Center, Temple, Texas, USA.
- VMM. 2010. Annual Report Water. Flemish Environmental Agency (VMM). 78pp.

Differentiation between fungi and bacteria as a source of N₂O formation in soil

Rohe, L.^a, Well, R.^a, Wrage, N.^b, Anderson, T.-H.^a and Flessa, H.^a

^aInstitute of Agricultural Climate Research, Johann Heinrich von Thünen Institute, Federal Research Institute of Rural Areas, Forestry and Fisheries, Braunschweig, Germany

^bFaculty of Life Sciences, Agricultural Sciences, Rhine-Waal University of Applied Sciences, Kleve, Germany

1. Background & Objectives

N₂O emissions of agricultural soils result predominantly from microorganisms, particularly produced during nitrification and denitrification. However, which part microbial groups contribute to N₂O formation is not sufficiently investigated yet. Understanding of N₂O sources and sinks is an important requirement for evaluating mitigation strategies of N₂O emissions. Pure culture studies showed that most fungi in soil lack N₂O reductase (Shoun et al., 1992) and that N₂O from bacterial and fungal denitrification exhibit different isotopomer ratios (e.g. Sutka et al., 2006, Sutka et al., 2008, Frame and Casciotti, 2010). Studies which combine ¹⁵N site preferences of N₂O (SP = difference between $\delta^{15}\text{N}$ of the central and terminal N-position of the asymmetric N₂O molecule (Well et al., 2006)) and the analysis of N₂O production by different microbial communities in soil to distinguish between bacterial and fungal N₂O are lacking so far. The objectives of this study are a) to determine the importance of fungal N₂O formation in a sandy arable soil, b) to verify, if the contribution of bacteria and fungi to N₂O emission can be assessed by analyzing SP, and c) to determine the effect of N₂O reduction on SP. To this end, we used the same approach as in substrate-induced respiration with selective inhibition (SIRIN) (Anderson and Domsch, 1975).

2. Materials & Methods

We used a sandy soil (Braunschweig, Germany) with 80% water filled pore space and flushed the headspace with N₂ to achieve denitrifying conditions. N₂O produced by fungi or bacteria was quantified in incubation experiments using the same selective inhibitors for bacteria and fungi as used in SIRIN. The following four treatments were tested: a) control without growth inhibition, b) inhibition of bacterial growth, c) inhibition of fungal growth and d) inhibition of bacterial and fungal growth. In a full factorial design, this was combined in two variants with N supplied as ¹⁵N-labelled or non-labelled NO₃⁻ fertilizer. In addition all treatments were analyzed with and without blocking the N₂O reduction by acetylene. Production of N₂O was determined in all treatments. The non-labelled treatments with selective inhibition were used to determine SP of fungal and bacterial N₂O, respectively. Isotopic signatures of N₂O in the non-labelled treatments were used to estimate isotope effects of N₂O production by fungal and bacterial denitrifiers. In the treatments with acetylene addition N₂O reduction was blocked to determine the isotope effect of the NO₃⁻ to -N₂O step and thus avoiding isotope effects by N₂O reduction to N₂. For the treatments without acetylene addition, ¹⁵N₂ analysis in the ¹⁵N-labelled variant was conducted to estimate the impact of N₂O reduction on isotopic signatures of N₂O in the non-labelled treatments.

3. Results & Discussion

The respiratory fungal/bacterial ratio indicated domination of fungi. Net N₂O production was highest in the treatment without any inhibitor (control) followed by the treatment with bacterial growth inhibition showing that fungal N₂O fluxes were relevant. Treatments with both inhibitors (N₂O production of uninhibited organisms) yielded lowest N₂O production. Using acetylene in the non-labelled treatments yielded higher N₂O production than without acetylene with highest effect in bacterial dominated treatments (70% increase in N₂O production), whereas the other treatments exhibited lower and relatively similar effects (42 to 47% increase in N₂O production).

Currently, isotope analysis of gas samples is conducted. Based on this, we will calculate isotopologue signatures of fungal and bacterial N₂O. These results will be presented and discussed.

References

- Anderson, J.P.E. and Domsch K.H. 1975. Measurement of bacterial and fungal contributions to respiration of selected agricultural soils. *Canadian Journal of Microbiology* 21, 314-322.
- Frame C-H. and Casciotti, L. 2010. Biogeochemical controls and isotopic signatures of nitrous oxide production by a marine ammonia-oxidizing bacterium. *Biogeosciences* 7, 2695-2709.
- Shoun, H., Kim, D.-H., Uchiyama, H. and Sugiyama, J. 1992. Denitrification by fungi. *FEMS Microbiology Letters* 94, 277-282.
- Sutka R.L., Ostrom, N.E., Ostrom, P.H., Breznak, J.A., Gandhi, H., Pitt, A.J. and Li, F. 2006. Distinguishing Nitrous Oxide Production from Nitrification and Denitrification on the Basis of Isotopomer Abundances. *Applied And Environmental Microbiology*, 638-644.
- Sutka, R.L., Adams, G.C., Ostrom, N.E. and Ostrom, P.H. 2008. Isotopologue fractionation during N₂O production by fungal denitrification. *Rapid Communication in Mass Spectrometry* 22, 3989-3996.
- Well R., Kurganova, I., Lopes de Gerenyu, V. and Flessa, H. 2006. Isotopomer signatures of soil-emitted N₂O under different moisture conditions—A microcosm study with arable loess soil. *Soil Biology & Biochemistry* 38, 2923-2933.

Do cover crops affect leaching and soil accumulation of salt and mineral N?

Gabriel, J.L.^a, Almendros, P.^b, Quemada, M.^a

^aDpto. Producción Vegetal: Fitotecnia, ETS Ingenieros Agrónomos, Universidad Politécnica de Madrid, Avda. Complutense s/n, 28040 Madrid, Spain

^bDpto. Química Agrícola, ETS Ingenieros Agrónomos, Universidad Politécnica de Madrid

1. Background & Objective

Nitrate leaching beyond the root zone increases water contamination hazards and decreases crop available N. Using cover crops instead of leaving the land fallow is an alternative to reduce nitrate contamination in the vadose zone, as cover crops reduce soil mineral N accumulation and drainage. Cover crops may also enhance soil aggregate stability, and water retention capacity, two important characteristics in irrigated land. However, reducing drainage below the root system, by increasing evapotranspiration, could lead to soil salt accumulation. Salinity has already affected more than 80 million ha of arable land in many areas of the world (FAOSTAT, <http://www.fao.org/nr/water/aquastat/main/index.stm>), and in the Mediterranean region is one of the principal causes for yield reduction and land degradation. Few studies address both related problems simultaneously; therefore, a long-term evaluation of the potential effect on soil salinity and nitrate leaching is necessary to ensure that advantages of cover cropping are not compensated by potential disadvantages that could originate from soil salt accumulation.

2. Materials & Methods

The soil salinity and nitrate leaching evaluation is based on studies conducted over 4 years in a semiarid irrigated agricultural area of Central Spain. Three treatments were studied: barley (*Hordeum vulgare* L.); vetch (*Vicia villosa* L.), and; fallow during the intercropping period of maize (*Zea mays* L.). Cover crops were killed in late winter allowing seeding of maize of the entire trial in early spring, and all treatments were irrigated and fertilised following the same procedure. Soil salt and nitrate accumulation was determined along the soil profile before maize sowing. Soil analysis was conducted in samples from four 1.2 m deep holes per plot and at 6 depth intervals (every 0.20 m). The electrical conductivity of the saturated paste extract was measured in each soil sample with a conductimeter (Rhoades, 1996). Soil mineral nitrogen (N_{min}) was determined from the sum of nitrate and ammonium concentrations in 1M KCl soil sample extracts, obtained by spectrophotometry (Gabriel and Quemada, 2011). During the whole experiment, daily soil water content measurements from calibrated capacitance probes (Gabriel et al., 2010) were used to calculate drainage at 1.2 m depth, and applying a numerical model based on the Richards water balance equation (Vanclouster et al., 1996).

3. Results & Discussion

Our results showed that when irrigation water was adjusted to crop needs, drainage during the irrigated period was minimized (Figure 1) which led to an accumulation of soil salt and nitrate on the upper layers after maize harvest. Salt and nitrate leaching occurred mainly during the intercrop period. In cover crop treatments, the drainage period was shorter, and the amount of drainage water and nitrate and salt leached were lower than in the fallow. This effect led to a larger nitrate accumulation in the upper layers of the soil after cover crop treatments than after fallow. However, soil salt accumulation did not increase in treatments with cover crops, and even decreased in years with a large cover crop biomass production (Figure 2, April 2008 and 2010).

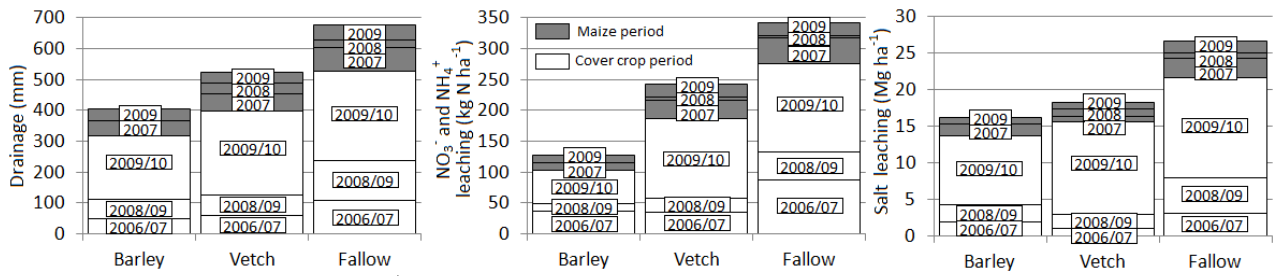

Figure 1. Drainage ($\text{NO}_3^- + \text{NH}_4^+$) and salt leaching for the various treatments from October 2006 to April 2010.

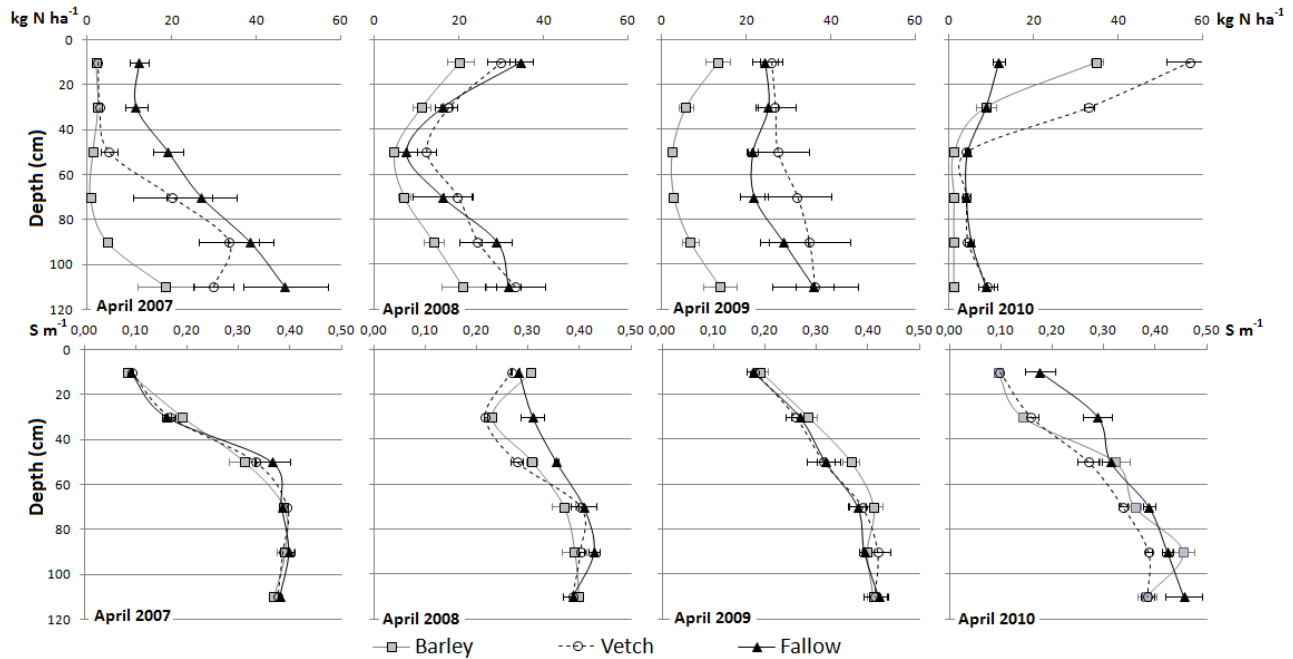

Figure 2. Distribution of soil N_{min} (kg N ha^{-1}) and saturated paste extract soil electrical conductivity (S m^{-1}) by depth at the end of the cover crop growing season (maize sowing), as influenced by the cover crop treatment.

4. Conclusion

Adoption of cover crops in this irrigated cropping system reduced water percolation beyond the root zone; as a consequence salt and nitrate leaching diminished but did not lead to salt accumulation in the upper soil layers.

Acknowledgements:

Financial support by CICYT (AGL2008-00163/AGR) and CAM (AGRISOST, S2009/AGR1630).

References

- FAOSTAT. Aquastat, <http://www.fao.org/nr/water/aquastat/main/index.stm> (verified on March 26th 2012).
- Gabriel, J.L., Lizaso, J.I. and Quemada, M. 2010. Laboratory versus field calibration of Capacitance Probes. *Soil Science Society of America Journal* 74, 593-601.
- Gabriel, J.L. and Quemada, M. 2011. Replacing bare fallow with cover crops in a maize cropping system: Yield, N uptake and fertiliser fate. *European Journal of Agronomy* 34, 133-143.
- Rhoades, J.D. 1996. Salinity: electrical conductivity and total dissolved solids. In D.L. Sparks (ed.) *Methods of soil analysis. Part 3. Chemical methods*. SSSA Book series no. 5. ASA and SSSA, Madison, WI, US. pp. 417-435.
- Vanclooster, M., Viaene, P., Diels, J. and Christiaens, K. 1996. WAVE: a mathematical model for simulating water and agrochemicals in the soil and vadose environment. En: *Reference and user's manual (Release 2.0)*, Institute for Land and Water Management, Katholieke Universiteit Leuven, Belgium.

Does groundwater level determine GHGs emissions from fertilized soil?

Cocco E.^a, Morari F.^a, Bertora C.^b, Grignani C.^b, Delle Vedove G.^c, Polese R.^a, Berti A.^a,

^aDepartment of Environmental Agronomy, University of Padova, Italy

^bDepartment of Agronomy, Forestry and Land management, University of Torino, Italy.

^cDepartment of Agriculture and Environmental Sciences, University of Udine, Italy

1. Background & Objectives

Agriculture generates approximately 10-12% of the total greenhouse gases (GHGs) with major contributions in terms of N₂O emissions (Snyder et al, 2009). Fluxes of GHGs are affected by water content in soil. Rainfall, irrigation and groundwater level affect denitrification and the subsequent production of N₂, NO, N₂O. The lysimeter study here presented aims to evaluate the influence of groundwater level on GHG emissions (CO₂, CH₄ and N₂O) from soil receiving organic and mineral fertilization.

2. Materials & Methods

The experiment (26/6/2011- 2/11/2011) was conducted in the Veneto Region (NE Italy) in 12 loamy-soil drainage lysimeters (1 x 1 m² width x 1.5 m depth) cropped with maize (*Zea mays* L.). Overall precipitation and irrigation during the monitored period were 1100 mm y⁻¹. The factorial combination of three shallow water table levels (free drainage, 60 cm and 120 cm depth) with two levels of N input (250 and 368 kg ha⁻¹ y⁻¹) was compared. The experimental layout was completely randomised with two replicates. Fertilisation consisted in a mix of beef manure and poultry litter (for M treatments) at two doses (170 and 250 kg N ha⁻¹ y⁻¹) incorporated before crop sowing, integrated with top-dressed urea (U) at 80 kg N ha⁻¹ and 118 kg N ha⁻¹, respectively. GHG flux rates from soil were measured using an automatic close dynamic chamber system (12 chambers) (Delle Vedove et al., 2007). Chambers closed for measuring CO₂ concentration six times per day. During the sampling air was forced to circulate between the chamber and an infrared gas analyser (IRGA, SBA-4, P-Systems): 150 measures of CO₂ concentration (one every second) were performed during every closure. A non-linear regression between CO₂ and time was used to establish the increase of CO₂ concentration in every chamber.

N₂O and CH₄ concentration were obtained, on a daily basis, the first five days after fertilization and every two weeks for the remaining test-time. Chambers, in this case, were connected with an auto-sampler and air from chamber was stored in vials for N₂O and CH₄ analysis by gas chromatography. Three measures were taken for every closure (at the closure, 20 min and 50 min from the closure) : a linear model was preferred in this case for calculating N₂O and CH₄ fluxes. GHG daily emissions were tested with Kruskal-Wallis ANOVA.

3. Results and Discussion

Measured CO₂ fluxes represented the sum of autotrophic and heterotrophic respiration. An increase in CO₂ fluxes occurred a few days after fertilization and lasted 15 days. Values ranged from 2 to 10 μmol CO₂ m⁻² s⁻¹ for low N input and from 2 to 14 μmol CO₂ m⁻² s⁻¹ for high N input. Total emissions of CO₂ during the monitored period are shown in Table 1. Nitrous oxide fluxes started to be detectable three days after fertilization, in occurrence of the first irrigation (Figure 1). The largest fluxes were observed after the second urea application when very high soil temperature (up to 36°C in those days) occurred. Methane fluxes were not detectable. CO₂ fluxes were significantly affected by the presence of groundwater level while N₂O emissions (kg ha⁻¹ d⁻¹) appear to be constant between treatments.

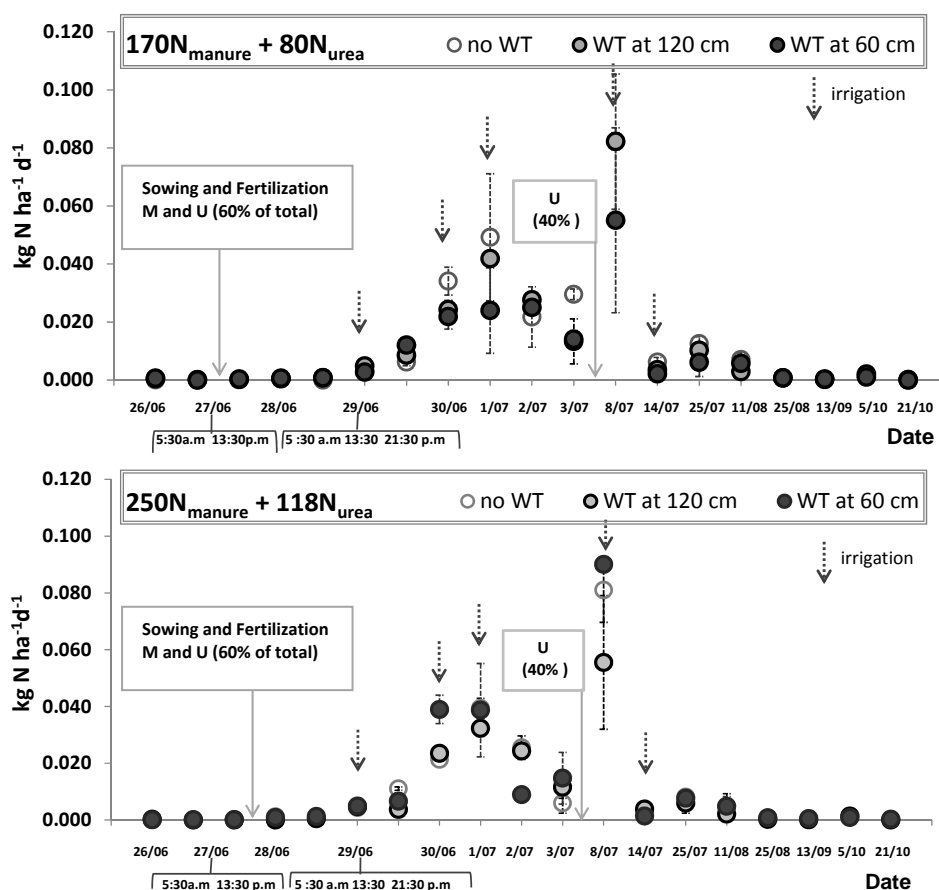

Figure 1.
Average fluxes of N_2O-N .
(26/6 - 2/11/2010).

Lower (graph above) and highest N fertilization (graph below) were compared in free drainage or with shallows water tables.

Nineteen sampling were performed in four month: two before N input e sowing , one sampling finished the operation of fertilization and sowing, one the first day, three the second day, one per day until the end of the first week. The rest of sampling every two week.

Irrigation (indicated by dotted arrow) manure and Urea (in particular second dose) affected N_2O fluxes in both graphs.

Table 1. Median daily emissions of CO_2 and N_2O . $kg CO_2-e = kg$ of carbon dioxide equivalent of N_2O emissions.

Fertilization		WT	$kg CO_2 ha^{-1} d^{-1}$	$kg N_2O-N ha^{-1} d^{-1}$	$kg CO_2-e ha^{-1} d^{-1}$
Manure	Urea				
170	80 $kg N ha^{-1} y^{-1}$	no WT	2.80c	0.0030	1.469
		WT at 120cm	4.34a	0.0029	1.400
		WT at 60 cm	4.08ab	0.0022	1.056
250	118 $kg N ha^{-1} y^{-1}$	no WT	3.19bc	0.0025	1.240
		WT at 120cm	4.29a	0.0020	1.020
		WT at 60 cm	3.67b	0.0014	0.703

4. Conclusion

Contrasting interactions of agronomic practices, soil and meteorological conditions affected results. A longer monitoring period will be necessary to highlight the potential effects of groundwater regimes on GHG emissions.

References

- Synder C.S., Bruulsema T.W., Jensen T.L. and Fixen P.E. 2009. Review of greenhouse gas emissions from crop production systems and fertilizer management effects. *Agriculture, Ecosystems and Environment* 133, 247-266.
- Delle Vedove G., Alberti G., Zuliani M., Peressotti A., Inglima I. and Zerbi G., 2007. Automated monitoring of soil respiration: an improved automatic chamber system. *Italian journal of Agronomy* 4, 377-382.

Dynamic of ammonia emission from urea spreading in Po Valley (Italy): relationship with nitrogen compounds in the soil

Carozzi, M.^a, Ferrara R.M.^{b,c}, Acutis M.^a, Rana G.^b

^a University of Milan, Department of Plant Production, Milan, Italy

^b CRA - Research Unit for Agriculture in Dry Environments, Bari, Italy

^c CRA - Research Centre for Agrobiolology and Pedology, Florence, Italy

1. Background & Objectives

The majority of ammonia (NH₃) emissions in the atmosphere are due to agricultural activities, with the major source being field-applied manure, followed by the use of inorganic fertilizer (Erisman et al., 2003). This loss of nitrogen (N) due to NH₃ emission may significantly reduce N-fertilizer efficiency and cause environmental problems (Asman et al., 1998). NH₃ volatilization from urea fertilizers has a slower dynamic than manure since urea does not contain ammoniacal N (NH₄⁺). In this case, it is necessary that hydrolysis process takes place under favourable conditions of soil water content and temperature. Appreciable NH₃ loss could occur within few days after the fertilizer application. Afterward the loss rate decreases due to the reduction of the total ammoniacal nitrogen (TAN = NH₃+NH₄⁺) which could be dissolved in increasing volumes of soil water (Sommer et al., 2004). The TAN depletion is shared by the NH₃ emission to the atmosphere and by the processes of immobilization and nitrification, through microbial activity. In this work, to define the end of the volatilization phenomenon, the NH₃ release has been discussed in relation to the pH and NH₄⁺ and nitrate (NO₃⁻) concentrations measured into the soil.

2. Materials & Methods

The trial was carried out in a corn field of approximately 10 ha located in Landriano (Po Valley, Northern Italy, Lat. 45°19' N, Long. 9°16' E, Alt. 88 m a.s.l.). From 14 June 2010, NH₃ concentration was measured daily for 24 days using the passive samplers ALPHA developed by Tang et al. (2001). Samplers were exposed in triplicate both in the center of the field and distant from the fertilized area, away from known NH₃ sources (about 1500 m). The ALPHAs in the field were maintained 1 m above the canopy, for up to 12 hours. Urea in granular form was surface spread the 18 June 2010 at a rate of 106 kg N ha⁻¹, and during the period of the experimentation the crop (maize, at stage V8) was not irrigated. A sonic anemometer (USA-1, METEK GmbH, Elmshorn, Germany) was placed in the centre of the field in order to collect data relative to the turbulent state of atmosphere (i.e. friction velocity, roughness and Monin-Obukhov lengths) and used as input for the WindTrax model (Flesch et al., 1995). A standard meteorological station was employed for measuring temperature and humidity of the air, global solar radiation, rain and wind speed. Random soil samples were collected (three replicates at 0-10 cm depth) in order to evaluate pH and the concentration of NH₄⁺ and NO₃⁻, the latter by using a spectrophotometer (FOSS, FIAstar 5000 system, Denmark); the timing of the soil sampling is reported in Table 1.

3. Results & Discussion

The hydrolysis of urea took place 1 day post application with a rain event occurred in the morning, which dissolved the fertilizer into the soil. The NH₃ volatilization reached a main peak of emission (about 5 µg m⁻² s⁻¹) around midday (no rain), followed by a decreasing due to an increasing in rainfall (about 20 and 13 mm during the day 19th and 20th, respectively). During the following four days, the NH₃ fluxes showed peaks around 1 µg m⁻² s⁻¹ during the morning, while starting from the 25th of June, the NH₃ fluxes decreased to rise slightly up on the 6th of July in occasion of a particular windy day. In order to evaluate if the volatilization of NH₃ was exhausted when the trial

was stopped in terms of NH_3 concentration measurements, the cumulated NH_3 volatilization between two successive soil sampling was computed and its relationship with pH and with NH_4^+ and NO_3^- into the soil was investigated (see Table 1).

Table 1. Averaged soil NH_4^+ and NO_3^- concentrations (0-10 cm), pH and NH_3 losses cumulated during the period between two successive soil samplings. Negative values are referred to ammonia deposition.

Date (dd/mm/yyyy)	$[\text{NH}_4^+]$ (mg kg^{-1})	$[\text{NO}_3^-]$ (mg kg^{-1})	NH_3 cumulated in the period (g N ha^{-1})	pH -
14/06/2010	7.5	15.3	0	6.2
15/06/2010	5.1	18.1	0	6.2
18/06/2010	7.9	12.6	992	6.3
21/06/2010	52.0	12.2	2065	6.5
22/06/2010	72.1	22.6	478	6.3
25/06/2010	11.7	22.6	581	6.1
29/06/2010	7.1	26.3	208	6.0
01/07/2010	5.7	24.6	181	6.1
02/07/2010	2.3	15.1	-181	6.1
04/07/2010	3.5	37.8	66	6.0
05/07/2010	2.2	24.6	53	6.0
06/07/2010	3.6	24.2	458	6.0
07/07/2010	3.9	28.6	103	5.9

The availability of NH_4^+ increased immediately after the start of urea hydrolysis, promoting NH_3 volatilization. However, at the same time of NH_3 fluxes decreasing (25th June), the NH_4^+ concentration decreased, while the NO_3^- concentration started to increase since the process of nitrification of the TAN mixed with soil had taken place. This later process is largely affected by soil pH, being negligible at values lower than ca. 4 and increasing linearly with pH increasing. During the trial, the pH increased when the hydrolysis took place (OH^- formation) and decreased with the course of the volatilization (H^+ release). Nitrification, therefore, reduces NH_3 emission due to reduction in both concentration of TAN in soil solution and a reduction in the NH_3 component of TAN.

4. Conclusion

Considering the dynamic of concentration of the two N compounds analysed into the soil, it seems reasonable suppose that the NH_3 volatilization was exhausted at the end of the experimental campaign, in combination with reduced pH values. The total NH_3 loss was around 5 kg N ha^{-1} , i.e. about 4.7% of the N supplied.

References

- Asman, W.A.H., Sutton, M.A. and Schjoerring, J.K. 1998. Ammonia: emission, atmospheric transport and deposition, *New Phytologist* 139, 27-48.
- Erismann, J.W., Grennfelt, P. and Sutton, M. 2003. The European perspective on nitrogen emission and deposition. *Environment International* 29, 311-325.
- Flesch, T., Wilson, J.D. and Yee, E. 1995. Backward-time Lagrangian stochastic dispersion models, and their application to estimate gaseous emissions, *Journal of Applied Meteorology* 34, 1320-1332.
- Sommer, S.G., Schjoerring, J.K. and Denmead, O.T. 2004. Ammonia emission from mineral fertilizers and fertilized crops. *Advances in Agronomy*, Volume 82, 557-622.
- Tang, Y.S., Cape, J.N. and Sutton, M.A. 2001. Development and Types of Passive Samplers for Monitoring Atmospheric NO_2 and NH_3 Concentrations. In *Proceedings of the International Symposium on Passive Sampling of Gaseous Pollutants in Ecological Research*. The Scientific World 1, 513-529.

Dynamics of in situ nitrogen mineralization from five organic fertilizers

Costa, L.A.d.M.^a, Costa, M.S.S.d.M.^a, Pereira, D.C., Cordovil, C.M.d.S.^b, de Varennes, A.^b

^aUNIOESTE, Campus de Cascavel, Rua Universitária 2069, Cascavel, Paraná, CEP. 85819110, Brazil

^bTU Lisbon, Instituto Superior de Agronomia, CEER, Tapada da Ajuda, 1349-017 Lisboa, Portugal

1. Background & Objectives

The use of organic residues as fertilizers has become a common practice both in organic as well as in traditional farming. The total available nitrogen (N) contained in organic fertilizers, and its rate of release, are important factors determining crop yield as well as potential losses into the environment through the processes of nitrification, leaching, and denitrification or other gaseous losses. Decomposition of organic materials and the subsequent release of inorganic N from the organic N pool occur through the activity of soil microorganisms, mainly bacteria and fungi (Hanselman et al., 2004; Flavel et al., 2006; Cordovil et al., 2011). Environmental and soil mineralogy factors affect the microbial players and their actions, which in turn determine the rate of N mineralization in the soil and thus the amount mineralized over time. Soil temperature and moisture content have a strong effect on N mineralization rates. A field experiment was set up to determine the rates of mineralization of five different organic fertilizers, in order to evaluate the potential for the release of available forms of N to the soil.

2. Materials & Methods

Different organic fertilizers (pelletized vermicompost (V); pelletized vermicompost + phosphate Arad (VP); compost (C); biodynamic compost (BC); poultry litter (PL)), were buried inside incubation capsules made of a porous ceramic material that allows water and nutrient exchange with the external environment. Each capsule had a diameter of 5.1 cm and a length of 9.8 cm and was filled with 20 g of residue. The experimental design was in randomized blocks, and capsules were buried at a depth of 7 cm and covered with soil. Destructive samples were collected at 7, 14, 35, 65 and 100 days after the beginning of the incubation. The material inside the capsules was removed, oven-dried at 65°C and weighed to determine decomposition by difference of mass. The samples were analyzed to determine the total nitrogen content (Kjeldhal digestion).

3. Results & Discussion

As expected, the residue which mineralized more intensely was the poultry litter (PL) losing about 33% of its original mass by the end of the incubation period. Three residues lost about 10% of their original weight by the end of 100 days of incubation (V, VP and CB), while the most recalcitrant was the compost (C) which lost only 5% of its biomass within the same period (Figure 1). The N concentration in the residues was greatest in PL and smallest in vermicompost (V and VP) at the beginning of the incubation (Table 1). During the incubation period, the concentration of N in the residue remaining in the capsule tended to be constant in compost (CB and C) while it decreased in the other residues, suggesting that the more labile compounds had a greater N concentration than the more recalcitrant. The addition of phosphorus to the vermicompost had no effect of the concentration of N in the residues over all the incubation period. The biodynamic compost had a greater concentration of N at the beginning of the incubation, but the differences were not significantly different later on, suggesting that the additional N present was very labile.

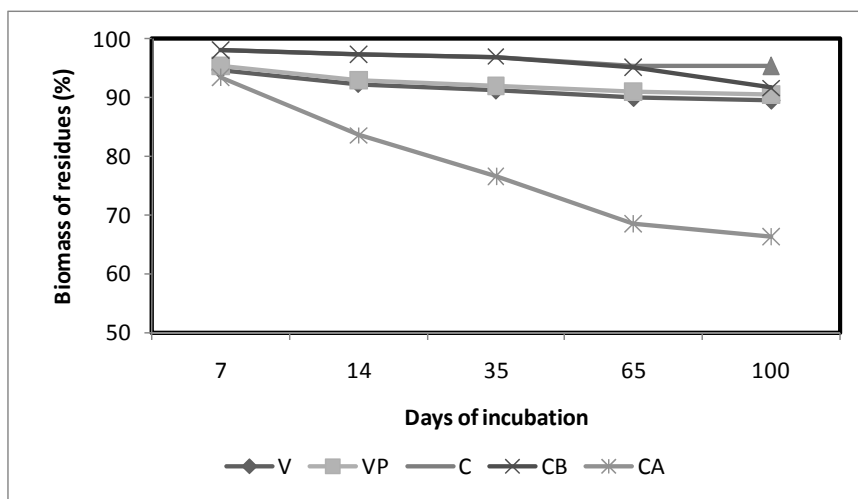

Figure 1. Decrease in the biomass of residues during the incubation period (%).

Table 1. Nitrogen concentration in the residues during the incubation period (mg N kg^{-1} residue).

TREATMENTS	Days						CV %
	0	7	14	35	65	100	
V	10.5 aD	9.1 bB	8.8 bB	8.9 bB	8.7 bC	8.7 bC	5.4
VP	10.1 aD	9.6 abB	9.0 bB	8.6 bB	8.8 bC	8.8 bC	7.5
C	19.9 aC	19.7 aA	18.6 aA	19.1 aA	19.1 aAB	19.4 aA	7.9
CB	20.9 aB	20.1 aA	20.7 aA	18.6 aA	19.7 aA	19.5 aA	9.0
CA	22.5 aA	18.6 bA	18.4 bA	17.3 bA	18.3 bB	18.1 bB	5.9
%CV	2.7	6.6	12.4	13.1	4.1	3.6	

Means in a column followed by the same capital letter or in a row followed by the same small letter are not significantly different as evaluated by the Tuckey test at $p < 0.05$.

4. Conclusion

This in situ incubation experiment showed the mineralization potential of five different residues, with poultry manure being the only residue capable of supplying a large amount of N within a 100-days period. The other residues are more appropriate to built up the organic matter in soils as they decompose very slowly.

References

- Cordovil C.M.d.S., de Varennes A., Pinto R. and Fernandes R.C. 2011 Changes in mineral nitrogen, soil organic matter fractions and microbial community level physiological profiles after application of digested pig slurry and compost from municipal organic wastes to burned soils. *Soil Biology and Biochemistry* 43, 845-852.
- Flavel T.C. and Murphy D.V. 2006 Carbon and nitrogen mineralization after application of organic amendments to soil. *Journal of Environmental Quality* 35, 183-193.
- Hanselman T.A., Graetz D.A. and Obreza T.A. 2004 A comparison of in situ methods for measuring net nitrogen mineralization rates of organic soil amendments. *Journal of Environmental Quality* 33, 1098-1105.

Effect of fertiliser type, rate and method of application on nitrogen leaching in organic olive oil farming

Gómez-Muñoz, B.^a, Bol, R.^b, Hatch, D.J.^b, García-Ruiz, R.^a

^aÁrea de ecología. Universidad de Jaén, Jaén, Spain

^bRothamsted Research, North Wyke, Okehampton, United Kingdom

1. Background & Objectives

Nitrogen (N) fertilisers are the most common amendments used in agroecosystems. However, N use efficiency is usually lower than 50 %, although this is highly dependent on crop type, environmental conditions and agroecosystem management practices, such as rates of fertiliser application, tillage and irrigation (Maeda et al., 2003). An optimum N fertilisation protocol should, as far as possible, synchronize fertiliser-N supply with plant demand, thereby minimizing the risk of N loss by leaching. Considering the wide diversity in the many types, of organic fertilisers used in organic agriculture (including N content), the potential risk for N leaching during decomposition of a variety of organic fertilisers needs to be evaluated under natural conditions. The objectives of this study were to assess the effect of fertiliser type, rate and method of application and tillage method on inorganic N leaching.

2. Materials & Methods

To evaluate N losses by leaching, a pot experiment was set up. Each pot contained 4 kg of sieved (< 4 mm) soil from an organic olive grove and received one of the following organic fertilisers commonly used in organic olive oil farming: i) Composted olive mill pomace (COMP), ii) Sheep manure (Sheep M) and iii) a commercial organic fertiliser with a total N content of 14 % (CPR). For comparison, a fourth treatment received NaNO₃ (Inor). N fertilisation rates were: 1) 250 µg N g⁻¹ ('single', hereafter) and 2) 500 µg N g⁻¹ ('double', hereafter). All fertilisers were added using 2 different application methods 1) at the soil surface (S), or 2) were mixed (M) within the soil. Two sets of control soils were also prepared; one set was undisturbed (simulating treatment S), whereas soil from the second set was mixed with the soil (simulating treatment M). Treatments were replicated four times, and the pots were randomly distributed in the open air at the garden facilities of the University of Jaén, Spain from November 2007 to May 2009. All pots were maintained with no vegetation. Each pot was fitted with a funnel connected to a 1 L plastic bottle to collect leachate after each rainfall event. Inorganic N (ammonium and nitrate) was analysed in the leachate after filtration. Differences in the treatments were tested using one-way analysis of variance (ANOVA) and Fisher's post hoc test.

3. Results & Discussion

Overall, ammonium leaching was negligible, accounting for a maximum of 6 % of the combined inorganic N forms (nitrate+ammonium). As expected, the overall temporal pattern of leached nitrate followed that of precipitation and the largest losses of nitrate coincided with the most intense rainfall periods in autumn and spring (Figure 1a). The highest losses occurred between late winter to early spring. The magnitude of nitrate losses differed between fertilisers. Up until the following spring, nitrate losses from the inorganic N fertilised pots were always the highest, especially after the first rainfall event following fertiliser addition, in which up to 15 % of the added N was lost. Figure 1b shows the fertiliser-derived IN lost after one year of incubation under a natural temperature and precipitation regime. There were significant effects of fertiliser type and application method on IN leaching, whereas the effects of application rate depended on the treatments (P<0.05) (Figure 1b). The lowest losses were for COMP amended soils (up to 7 % of

that applied) and the method of application had significant effects on IN leaching. Those soils which received COMP on the soil surface averaged negative IN losses (i.e. lower or similar losses to the control soil). N application rates had no effect on COMP IN leaching, regardless of the way COMP was applied. Overall, IN leaching for those pots which received either Sheep M or CPR did not differ significantly, although leaching after surface application of CPR was higher than Sheep M. Up to 37 % of the fertiliser-derived N was leached for the 'double' application surface application of CPR. No effects of rate and methods of application on IN leaching were found for CPR. However, for Sheep M, leaching was higher in double rate and lower in the surface compared with the mixed in application. The highest IN leaching reached 58 % of the added N for Inorganic fertiliser application.

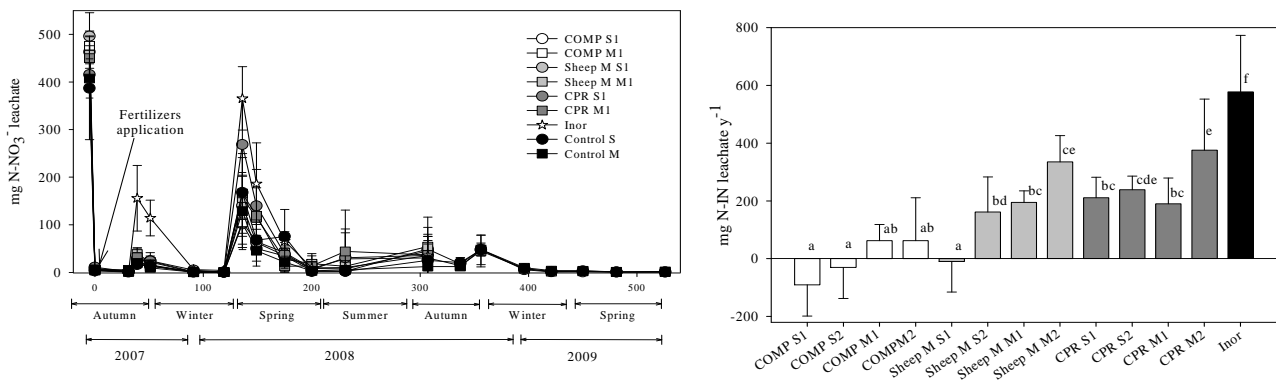

Figure 1(a) Temporal pattern of Nitrate-N loss by leaching for soil which did not receive N (control) or received composted olive mill pomace (COMP), sheep manure (Sheep M), commercial organic fertilisers (CPR) and NaNO₃ (Inor) at (1) 1 g N pot⁻¹ or 1000 mg N pot⁻¹, or (2) 2 g N pot⁻¹ or 2000 mg N pot⁻¹. M and S, stand for soil in which the fertilisers were mixed (M) with the soil or applied to the soil surface (S) and (b) cumulative fertiliser-derived IN leaching in year 1 under natural rainfall and temperature in outdoor conditions. Values are means of 4 replicates and bars denote standard deviations. Different letters denote significant differences ($P < 0.05$).

4. Conclusion

This work highlights the importance of management practices to increase the N use efficiency in agroecosystems. The lowest amount of nitrate lost by leaching was obtained after compost application (viz. less than the control), intermediate losses were found for manure, followed by commercial fertiliser applications and the highest N leaching was after inorganic fertiliser application. Overall, fertiliser-N application rate had no effect on the amount of IN leached.

There were no significant differences in the fertiliser-N availability measured through IN leaching between the two methods of fertiliser applications (viz. to the soil surface or mixed in with the soil) for inorganic and commercial fertilisers, probably because fertiliser-N was already available for both. This was not true for compost or manure, where N leaching was higher when fertilisers were mixed with the soil. Overall, organic fertilisers might be applied mixed with the soil in autumn whereas chemical and organic with high N content should be applied on early spring independently of the application method (surface or mixed).

References

Maeda M., Zhao B., Ozaki Y. and Yoneyama T. 2003. Nitrate leaching in an Andisol treated with different types of fertilizers. *Environmental Pollution* 121, 477-487.

Effect of long-term conservation and conventional tillage system on N₂O emissions under rainfed Mediterranean agro-ecosystem.

Télez, A.^a, García-Marco, S.^a, Ábalos, D.^a, Sánchez-Martín, L.^a, Sanz-Cobeña, A.^a, Tenorio, J.L.^b and Vallejo, A.^a.

^a ETSI Agrónomos, Technical University of Madrid, Ciudad Universitaria, 28040 Madrid, Spain

^b INIA, Departamento de Medio Ambiente. Ctra de La Coruña Km. 7,5. 28040 Madrid, Spain.

1. Background & Objectives

Agricultural soils are considered a source of N₂O emissions. This is due to the influence of many cropping and land management practices on the soil microclimate and cycling of C and N. Tillage practices affect chemical, physical and biological soil properties, and these interactions together with climatic conditions influence the magnitude of N₂O emissions (Passianoto et al., 2003; Oorts et al., 2007). Currently, there is no consensus in the literature on the differences in field N₂O emissions or mitigation between conservation tillage and conventional tillage (Snyder et al., 2009). Moreover, there is a lack of data on long-term tillage system studies, particularly in Mediterranean agro-ecosystems. The aim of this study was to evaluate the effects of long-term (>17 yr) tillage systems (conservation tillage and conventional tillage) and crop rotation on N₂O emissions.

2. Materials & Methods

The experiment was located in “Canaleja” field station (Madrid, Spain) on a sandy clay loam soil, where a long-term tillage trial began in 1994. The site has a semiarid Mediterranean climate with dry summer and wet winter. The 10 year mean annual average temperature and rainfall for this area were 13.6°C and 370.7mm. The current study was conducted between November 2010 and July 2011. The experimental design was a complete randomized block and each treatment was replicated three times. Tillage system was the main treatment. Three tillage systems were imposed in each main plot: no tillage (NT), minimum tillage (MT), both considered as conservation tillage system, and conventional tillage (CT). A fallow-wheat-vetch-barley annual rotation was established for each tillage system, but we only took samples in wheat-vetch plots. The experimental field consisted of eighteen subplots of approximately 250 m² (10 m wide and 25 m long) corresponding with each phase of rotation. Tillage management was carried out in autumn 2010. No tillage (NT) involved directly drilling and spraying with herbicides for weed control. Minimum tillage (MT) consisted of chisel ploughing (15 cm) and a cultivator pass. Conventional tillage (CT) consisted of a mouldboard plough pass (30 cm depth), followed by a cultivator pass for preparing the seedbed. In NT, crop residues were left on the soil surface. For MT, approximately 30% of the soil was covered with the previous crop residues. For CT, almost 100% of the crop residue was incorporated into the soil. After tillage, wheat and vetch were sown at the beginning of November 2010. Fertilizer was applied only to the soil where there was wheat seeding. These plots were fertilized with 16 kgN ha⁻¹ and 22 kg N ha⁻¹, applied at seeding and before tillering, respectively. N₂O fluxes were measured from November 2010 to July 2011, using the close chamber technique (Roelle et al., 1999). One chamber per plot was used for gas sampling. During the crop season, gas samples were taken from the chambers three times in the first and second weeks after fertilizer application and then twice per week during the first month. Subsequently, every two weeks sampling was carried out until the end of the crop period. Also, samples were taken two times per week during rainfall periods. Cumulative N₂O emissions during the sampling period were calculated by averaging the rate of loss between two successive determinations, multiplying that average rate by the length of the period between the measurements, and adding that amount to the previous cumulative total. Samples were

analyzed by gas chromatography (HP-6890). Also, soil dissolved organic C (DOC) and mineral N (NO_3^- and NH_4^+) concentrations were measured every time gas samples were taken.

3. Results & Discussion

During the experimental period, N_2O fluxes in wheat plots ranged from -0.081 to 0.224 $\text{mg N- N}_2\text{O m}^{-2} \text{d}^{-1}$ for CT and NT, respectively, and in vetch plots ranged from -0.133 to 0.331 $\text{mg N- N}_2\text{O m}^{-2} \text{d}^{-1}$ for NT and MT, respectively. Cumulative N_2O emissions were higher in conservation tillage system (0.050 $\text{kg N- N}_2\text{O ha}^{-1}$ and 0.074 $\text{kg N- N}_2\text{O ha}^{-1}$ for NT and MT) than in CT (0.025 $\text{kg N- N}_2\text{O ha}^{-1}$), under wheat-vetch rotation (Figure 1). On the other hand, vetch, as a legume, has the capacity for fixing N_2 and this crop showed greater N_2O emissions than wheat. Plots under vetch showed a larger pool of mineral N (NH_4^+ and NO_3^-) available in the soil. Also, higher N_2O cumulative emissions from vetch were observed in MT than in NT and CT. However, higher N_2O cumulative emissions from wheat were observed in NT than in MT and CT. Moreover, in NT and MT there is a higher dissolved organic C content available for microorganism activity than CT and this may favor the creation of anaerobic microsites in the soil during microbial respiration; these conditions could lead to N_2O emissions coming from denitrification in the soil. Therefore, CT could help to mitigate N_2O emissions in wheat-vetch rotations under Mediterranean climates.

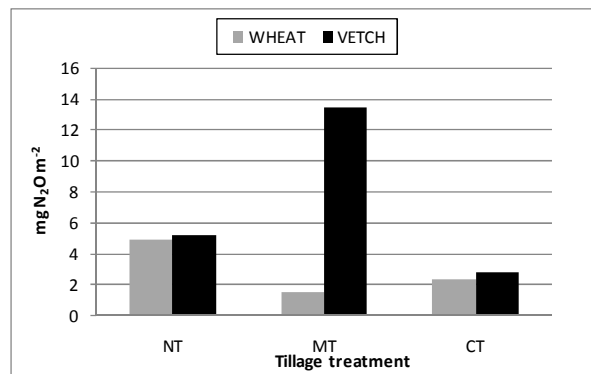

Figure 1. N_2O cumulative emissions in each tillage system: NT (no tillage), MT (minimum tillage) and CT (conventional tillage).

4. Conclusion

After soil has been 18 years under three tillage systems, conventional tillage induced lower cumulative N_2O cumulative emissions than conservation tillage (NT and MT) in wheat-vetch rotations under Mediterranean agro-ecosystems.

References

- Oorts, K., Merckx, R., Grehan, E., Labreuche, J. and Nicolardot, B., 2007. Determinants of annual fluxes of CO_2 and N_2O in long-term no-tillage and conventional tillage systems in northern France. *Soil Till. Res.* 95, 133-148.
- Passianoto, C.C., Ahrens, T., Feigl, B., Steudler, P.A., do Carmo, J.B. and Melillo, J.M. 2003. Emissions of CO_2 , N_2O , and NO in conventional and no-till management practices in Rondonia, Brazil. *Biol. Fertil. Soils* 38, 200-205.
- Roelle, P., Aneja, V. P., O'Connor, J., Robarge, W., Kim, D. and Levine, J. S. 1999. Measurement of nitrogen oxide emissions from an agricultural soil with a dynamic chamber system. *J. Geophys. Res.* 104, 1609-1619.
- Snyder, C.S.; Bruulsema, T.W.; Jensen, T.L. and Fixen, P.E. 2009. Review of greenhouse gas emissions from crop production systems and fertilizer management effects. *Agric. Ecosyst. Environ.* 133, 247-266.

Effect of N-fertilizer amount and nitrification inhibitor on N₂O emissions from a sandy and a loamy soil under vegetable production

Seiz, P.^a, Schulz, R.^a, Heger, A.^b, Armbruster, M.^b, Wiesler, F.^b, Müller, T.^a, Ruser, R.^a

^aInstitute of Crop Science, Department of Fertilisation and Soil Matter Dynamics (340i), University of Hohenheim, Stuttgart, Germany

^bLandwirtschaftliche Untersuchungs- und Forschungsanstalt Speyer, Speyer, Germany

1. Background & Objectives

High soil N surpluses, and resultant losses of reactive N to the environment, during the production of vegetable crops, such as cauliflower, are currently a matter of intense debate in Germany. Measures such as the lowering of N-fertilizer inputs or the use of nitrification inhibitors (NIs) have been shown to reduce nitrate leaching (Wiesler et al., 2007). The effect of such measures on the release of the greenhouse gas, nitrous oxide (N₂O), however, has rarely been quantified. Pfab et al. (2011) reported lower N₂O emissions from a vegetable cropping system when fertilizer N inputs were reduced. However, this reduction in N inputs also reduced crop yield. The aim of this study was to quantify annual N₂O emissions from different sites within two big vegetable production regions of Germany, and to assess the effectiveness of mitigation measures in reducing N-surpluses, and hence N₂O emissions, without restricting crop yield.

2. Materials & Methods

Field trials were conducted on two different study sites representative of two big vegetable production regions of Southern Germany. The first site is within the so called 'Filderebene' region (13 km south of Stuttgart 410 m a. s. l.). The soil type is a haplic luvisol (loamy soil), mean annual precipitation is 686 mm, and the long-term (LT) mean annual air temperature is 8.8°C. The second site is within the 'Vorderpfalz' vegetable production region (20 km south of Mannheim near Speyer, 99 m a. s. l.). The soil type is a sandy cambisol, mean annual precipitation is 593 mm, and the LT mean annual air temperature is 10.0°C. At both sites, fully randomized block experiments with four replicates, were established. In this study the results of the following treatments are presented: (i) control (0 N), (ii) High N (325 kg N ha⁻¹ to cauliflower), (iii) Optimized N (250 kg N ha⁻¹), (iv) Low N (190 kg N ha⁻¹ with the option of additional N doses if the chlorophyll content decreased as compared to treatment 250 kg N), and (v) Optimized N with 3,4-dimethylpyrazole phosphate (DMPP) as NI. Fertilizer application was split as shown in Figure 2. Ammonium sulfate nitrate (ASN) was used as the N-fertilizer at all sites and in all treatments. N₂O flux measurements, made using the closed chamber method (Flessa et al., 1995), were conducted weekly and additional event-oriented measurements were carried out following N-fertilization and heavy rain fall. In this paper, we present the first results of our investigations which are still on-going.

3. Results & Discussion

Cumulative N₂O emissions ranged from 0.71 kg N₂O-N ha⁻¹ on the unfertilized control treatment at 'Vorderpfalz' to 1.95 kg N₂O-N ha⁻¹ on the treatment 'optimized N with NI' at 'Filderebene' (Figure 1). Since N-fertilization provides the substrates for N₂O production in soils, the emissions from the fertilized treatments exceeded those from the unfertilized control. Among the fertilized treatments, the emissions from the sandy soil were lower than those from the loamy soil. These differences were significant for the treatment 'N optimized with NI'. The higher N₂O emission from the loamy soil compared to that from the sandy soil, might have been owed to the higher water holding capacity and hence lower aeration of the loamy soil, since this would have favored denitrification (Granli and Bøckman, 1994). The highest N₂O fluxes during the experimental period occurred after the first application of N fertilizer, directly after planting the cauliflower (Figure 2). The lowest fluxes were measured

in treatment 'Low N'. Subsequent measurements will show whether different N-fertilizer amounts also help to reduce the N₂O emission on an annual base.

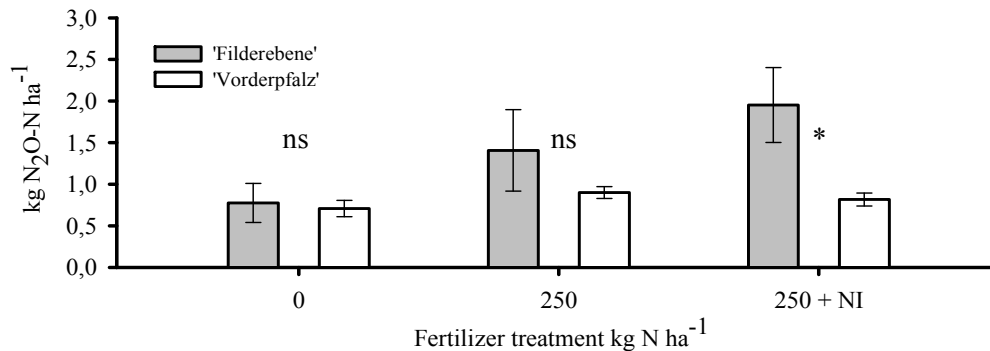

Figure 1. Mean cumulative N₂O emissions (\pm standard deviation) for the period 3rd Aug.-24th Oct 2011 as affected by study site, N fertilization, and NI application. * indicate significant difference at $p=0.006$ (t-Test).

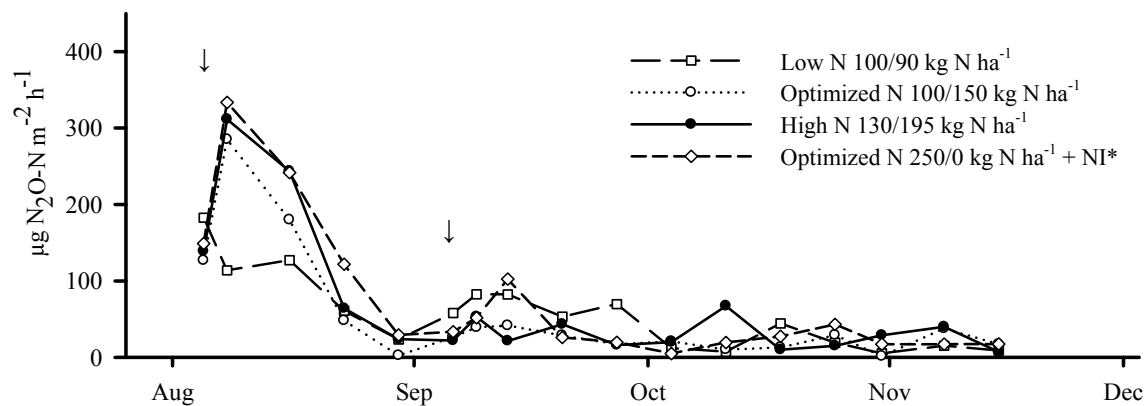

Figure 2. Mean N₂O flux rates ($n=4$) of differently fertilized treatments at the study site 'Filderebene'. Arrows indicate the date of N applications. *Nitrification Inhibitor

4. Conclusions

N₂O emissions from the fertilized sandy soil were considerably lower than those from the loamy soil. One reason for the higher fluxes from the loamy soil may have been its higher soil moisture content relative to the sandy soil. Subsequent measurements and parameterization of the N₂O fluxes will show whether a soil moisture controlling irrigation system would help to reduce N₂O emissions. The reduction of N-fertilization with the provision that additional N may be applied if needed, ('Low N') appears to be a suitable approach for mitigating N₂O emissions. In contrast to earlier investigations, the use of a NI did not reduce N₂O emissions at either study site. However, these conclusions are based on results collected over a very short time period and need to be further verified using annual data.

References

- Flessa, H., Dörsch, P. and Beese, F. 1995. Seasonal variation of N₂O and CH₄ fluxes in differently managed arable soils in southern Germany. *J. Geophysical Res.* 100, 115-124.
- Granli, T. and Bøckman, O.C. 1994. Nitrous oxide from agriculture. *Norwegian Journal of Agriculture*, Supplement 12.
- Pfab, H., Palmer, I., Buegger, F., Fiedler, S., Müller, T. and Ruser, R. 2011. N₂O fluxes from a Haplic Luvisol under intensive production of lettuce and cauliflower as affected by different N-fertilizer strategies, *J. Plant Nutr. Soil Sci.* 174, 545-553.
- Wiesler, F., Laun, N. and Armbruster, M. 2007. Integriertes Stickstoffmanagement – eine Strategie zur wirksamen Verringerung der Gewässerbelastung im Gemüsebau. Download: www.agrarforschung.de/download/07_wiesler.pdf

This study was funded by the German 'Federal Office for Agriculture and Food' (BLE)

Effect of nitrogen fertilizer amount and a nitrification inhibitor on the N₂O emissions from a loamy soil cropped with winter wheat

Guzman Bustamante, I.^a, Schulz, R.^a, Müller, T.^a, Hähndel, R.^b, Ruser, R.^a

^aInstitute of Crop Science, Fertilization and Soil Matter Dynamics (340i), University of Hohenheim, Stuttgart, Germany

^bK+S Nitrogen GmbH, Mannheim, Germany

1. Background & Objectives

Nitrous oxide (N₂O) is a climate relevant trace gas which contributes 8% to the anthropogenic greenhouse effect (IPCC, 2007). Furthermore it is also involved in stratospheric ozone depletion. In agricultural used soils nitrogen (N) fertilization supplies the substrate for the processes of nitrification and denitrification causing potential N₂O losses. A promising N₂O reducing strategy in agricultural used soils is the use of nitrification inhibitors (NI). Compared with a conventional N-fertilizer application, Akiyama et al. (2010) calculated a reduction potential of >30% when NIs were added to the fertilizer. The objective of this study is to quantify the effect of a NI application and the N-fertilizer amount on the annual N₂O emissions from a loamy soil cropped with winter wheat.

2. Materials & Methods

N₂O emissions were measured in a fully randomized block experiment on the experimental station “Heidfeldhof” of the University of Hohenheim, 13 km south of Stuttgart, Germany, between mid-March and mid-December 2011. A nitrogen fertilization rate of 0 (unfertilized control), 120 (N1), 175 (N2) or 230 (N3) kg N ha⁻¹ was applied as ammonium sulfate nitrate (ASN) or ENTEC26[®] (ASN+NI) to winter wheat sown in 2010. N2 fertilization amount was calculated according to the German Fertilizer Ordinance (“good practice”), N1 and N3 as a reduction or an increase of a 30% of N2, respectively.

3. Results & Discussion

The spring season was extremely dry. Over the period between mid-March and mid-December 2011 the average precipitation amount was 30% lower than the average precipitation 2007- 2010. The largest difference we observed in mid-June (-50%). As a result of low soil water content the overall level of the N₂O fluxes were very low in comparison with previous field measurements.

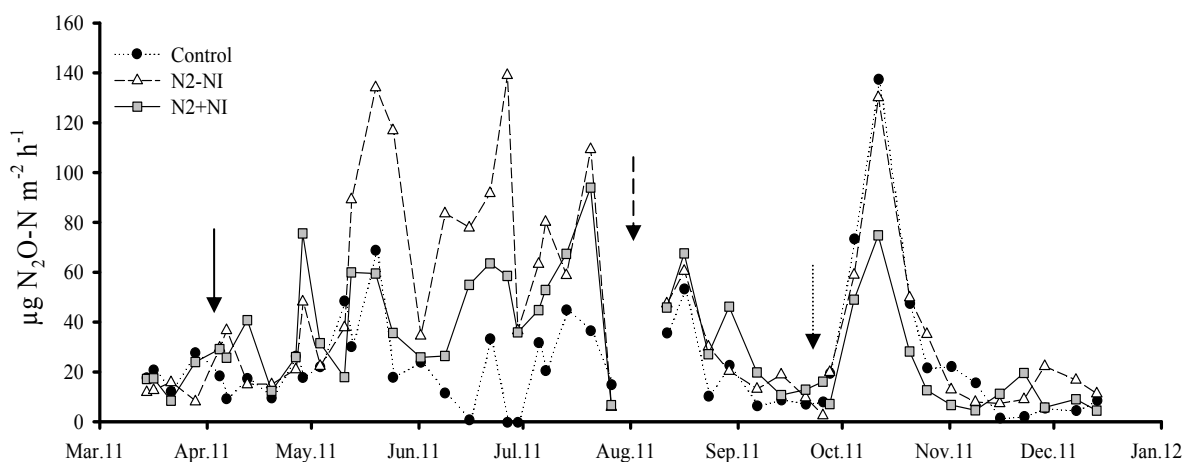

Figure 1. Mean N₂O flux rates as affected by N-fertilization and by the addition of a NI. Unfertilized control, N2 -NI or +NI. Solid arrow indicates N fertilization, long dashed arrow harvest and soil tillage, and dashed arrow stubble tillage.

High N₂O fluxes immediately after N fertilization were not observed (Figure 1). Nevertheless, cumulative emissions during the vegetation period (15.03.-27.07.2011) varied between 764 and 2237 g N₂O-N ha⁻¹ (Figure 2), mainly as a result of high emissions after rewetting events. The highest N₂O fluxes were observed the 26th of May (158 µg N₂O-N m⁻² h⁻¹, not shown). In the period after the harvest a high variability between all treatments could be observed. The addition of an NI to the N2 and N3 treatments tended to reduce the N₂O emission over a period of approximately 8 weeks (mid-May until mid-July). This effect was also observed for approximately three weeks after harvest. The N1 treatment did not show the same trend. The prolonged N₂O reducing effect of ENTEC26[®] was already observed by Pfab et al. (2012). Despite the application of N fertilizer dated back 10 to 15 weeks before, they found a significant decrease of N₂O winter fluxes by ENTEC26[®]. In comparison with the N2 treatments +NI and -NI, the reduction and the increase by a 30% of the N amount had neither a significant effect on grain yield, nor a significant reduction of the mean cumulative N₂O emissions.

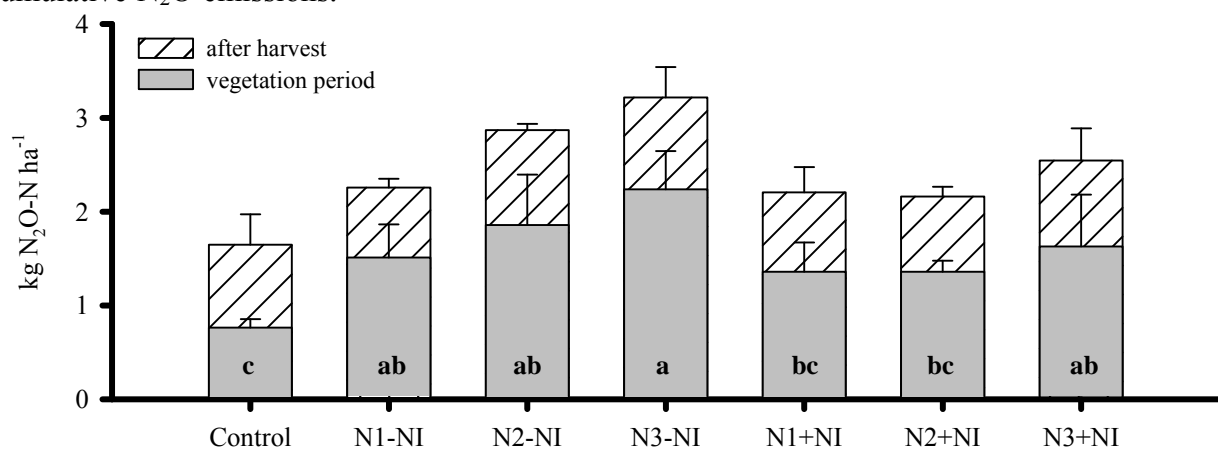

Figure 2. Mean cumulative N₂O emissions during vegetation period (155 d) and after harvest (119 d). Means after harvest show no significant differences. Means during vegetation period with the same letter are not significantly different (Student-Newman-Keuls $\alpha=0.05$).

4. Conclusion

Our investigations were carried out under unusually dry conditions. As compared to other studies in our experimental region, the N₂O emissions were very low. However, a trend of reduced fluxes was observed when NI was added to the N fertilizer. Interestingly, N₂O fluxes after stubble management were again lower in the N2 and N3 +NI than in the respective -NI treatments. On-going investigations will focus on that long-term effect of a NI on N₂O fluxes and the microbial community structure.

References

- Akiyama H., Yan X. and Yagi K. 2010. Evaluation of effectiveness of enhanced-efficiency fertilizers as mitigation options for N₂O and NO emissions from agricultural soils: meta-analysis. *Global Change Biology* 16, 1837-1846.
- IPCC. 2007. Changes in Atmospheric Constituents and in Radiative Forcing. In: Solomon S. et al., *Climate Change 2007: The Physical Science Basis*. Contribution of Working Group I to the Fourth Assessment Report of the Intergovernmental Panel on Climate Change, Cambridge University Press, Cambridge, United Kingdom and New York, USA.
- Pfab H., Palmer I., Buegger F., Fiedler S., Müller T. and Ruser R. 2012. Influence of a nitrification inhibitor and placed N-fertilization on N₂O fluxes from a vegetable cropped loamy soil. *Agriculture, Ecosystems and Environment*, (under review).

Effect of soil compaction and nitrogen fertilization on nitrous oxide emission from highly productive grassland

Loges R., Schmeer M., Taube F.

Christian-Albrechts-University of Kiel, Institute for Crop Science and Plant Breeding, Grass and Forage Science/Organic Agriculture, Germany

1. Background & Objectives

Nitrous oxide (N₂O) emissions induced by agricultural systems represent 50% of the world's N₂O emissions. This can significantly be attributed to an intensification of modern agriculture which includes increased nitrogen fertilization and also the employment of larger and heavier machines. Heavier machines can cause an increase in soil compaction and a reduction in soil porosity which can result in more anaerobic conditions in the upper soil layers. In combination with intensive nitrogen fertilization these can contribute to an undesirable increase in N₂O emissions (Yamulki and Jarvis, 2002; Velthof et al., 1997). Since most studies dealing with soil compaction focus on tilled arable land, our main aim was to study the interaction between soil compaction and nitrogen fertilization and its impact on N₂O emissions in highly productive grassland.

2. Materials & Methods

The field experiment was set-up on the experimental station Hohenschulen in Northern Germany (54:18:49N; 9:57:56E; mean annual temperature 8.3°C, and mean annual precipitation 777 mm, soil: sandy loam) on a uniform grassland (seed mixture of *Lolium perenne*, *Dactylis glomerata*, *Medicago sativa* and *Trifolium repens*) in a split-plot factorial design with three replicates. The experiment comprised the following factors:

- Controlled soil compaction (control versus contact area pressure of 228 kPa) in early April
- N fertilization with calcium ammonium nitrate (0 and 360 kg N ha⁻¹)
- Year of first controlled soil compaction on separate plots (2006, 2007 and 2008)

Soil compaction was carried out each year on originally non compacted plots. It was achieved by a single passage of a tractor with a slurry tanker (total weight 22 t). Each plot was harvested three times per year. N₂O emissions were determined according to the "closed-chamber"-method during a time period from early April to mid-November in each experimental year (Hutchinson and Mosier, 1981). PROC MIXED of SAS 9.1 was used for statistical analysis. Means were compared by t-test and Bonferroni-Holm adjustment. Significance was declared at P<0.05.

3. Results & Discussion

N₂O emission rates were strongly affected by the tested treatments as indicated by a significant threefold interaction (experimental year x compaction x fertilization) (Table 1).

Table 1. P-value of the analysis of variance of the parameter N₂O-emission (cumulative N₂O-N kg*ha⁻¹) (y = year, comp = compaction, N = N-fertilization).

	y	comp	N	y*comp	y*N	comp*N	y*comp*N
N ₂ O	0.0953	0.0587	<0.0001	0.3861	0.2618	0.0270	0.0084

No compaction-induced effects are perceptible on the unfertilized treatments (Figure 1). In 2006 and 2008, the compaction led to a sharp increase of N₂O emissions on fertilized plots. In both years soil compaction was carried out on moist soil. In 2007, however, no effects of compaction could be

detected due to dry weather conditions in spring. The high N₂O emissions of 2007 in both, the compacted and the non-compactd fertilized treatments originate in rewetting of soil after heavy rains in summer (detailed data not shown). In the legume-dominated unfertilized treatment, soil compaction had no influence on N₂O emissions in spring. Due to a high proportion of alfalfa (67% of DM) the DM-yields of the unfertilised plots (16.2 t ha⁻¹ year⁻¹) did not differ significantly from the fertilised treatments (data not shown).

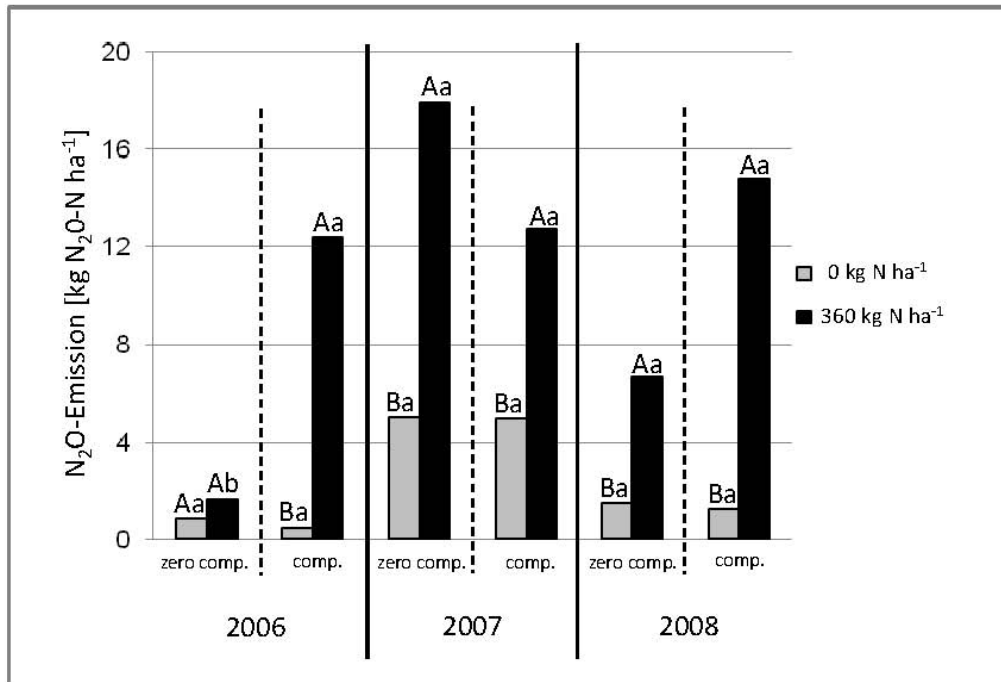

Figure 1. Cumulative nitrous oxide emissions [kg N₂O-N ha⁻¹] for soil compaction and N-fertilization treatments in 2006-2008; Capital letters indicate significant differences due to fertilization, lower case indicate significant differences due to soil compaction.

4. Conclusion

To minimise N₂O emissions from grassland, soil compaction should be avoided, especially under wet soil conditions and simultaneous high N-application. Forage legumes can compensate for the absence of nitrogen fertilisation, in terms of DM yield, and showed potential to reduce N₂O emissions by approx. 75%.

References

- Hutchinson G. L. and Mosier A. R. 1981. Improved soil cover method for field measurement of nitrous oxide fluxes. *Soil Science Society of America* 45, 311-316.
- Velthof G.L., Oenema O., Postma R. and Van Beusichem M.L. 1997. Effects of type and amount of applied nitrogen fertilizer on nitrous oxide fluxes from intensively managed grassland. *Nutrient Cycling in Agroecosystems* 46, 257-267.
- Yamulki S. and Jarvis S. C. 2002. Short-term effects of tillage and compaction on nitrous oxide, nitric oxide, nitrogen dioxide, methane and carbon dioxide fluxes from grassland. *Biology and Fertility of Soils* 36, 224-231.

Effects of anaerobic digestion of organic manures on N turnover and N utilization

Sørensen, P.^a, Khan, A.R.^a, Møller, H.B.^b, Thomsen, I.K.^a

^a Aarhus University, Department of Agroecology, 8830 Tjele, Denmark

^b Aarhus University, Department of Biosystems Engineering, 8830 Tjele, Denmark

1. Background & Objectives

Animal manures and plant-based manures are used for biogas production by anaerobic digestion (AD). After AD the concentration of ammonium-N in manure is increased and the concentration of decomposable C is decreased. Thus, the potential first year fertilizer value of the manure can be increased by the treatment. However, pH is also increased by AD thereby increasing the risk of ammonia losses. The objective of this paper was to compare N turnover in soil after application of digested and corresponding undigested manures, and to compare N fertilizer values of digested manures after direct injection or surface-banding in cereals.

2. Materials & Methods

Cattle and pig slurries, a dairy cattle feed mixture (mainly maize silage), cattle faeces (cow fed on the same diet) and plant-based green manures were digested in continuously fed pilot digesters at thermophilic conditions (47-53°C) as described by Møller et al. (2007). The average hydraulic retention time was about 20 days. Two experiments were carried out each involving selected digested and non-digested products. In the first experiment the net release of mineral N from digested and non-digested manures applied to soil was measured in a laboratory incubation study with a sandy loam soil incubated at 20°C. Soil mineral N was extracted with 1M KCl 4, 7, 14, 28, 84 and 119 days after manure application. In the second experiment, the mineral fertilizer replacement values of total N (MFRV) were measured in framed field plots on a loamy sandy soil where grain yields and N uptake were compared to plots receiving increasing amounts of mineral N fertilizer (Sørensen and Eriksen, 2009). The manures were surface-banded in spring in winter wheat simulating a trailing hose application (150 kg total N ha⁻¹) or applied in a band at 10 cm depth simulating a direct injection before sowing spring barley (80 kg total N ha⁻¹).

3. Results & Discussion

In the incubation experiment the proportion of total N on ammonium form increased after AD and more mineral N was released during decomposition in soil (Figure 1). For slurry the increase in mineral N release was equivalent to about 10-25% of total slurry N. After AD of the cattle feed mixture the mineral N release in soil increased from about 20% of total N to about 80%, and AD of cattle faeces (from cattle fed the same diet) increased the mineral N release in soil from about 20% of total N to about 60% (Figure 1). In the field experiment the MFRV of the two injected cattle slurries applied to barley increased from 58% and 75% of total N to 69% and 82% with AD (Table 1). The MFRV of cattle slurry after surface-banding in winter wheat was significantly lower. The low availability after surface-banding was ascribed to high ammonia volatilization losses. The MFRV of injected pig slurry was high (89-91%) and similar with and without AD. After surface banding of pig slurry MFRV was 75% for untreated and 87% for digested pig slurry. Thus, the reduced fertilizer value after surface banding was most significant for the manures with the highest dry matter content as was expected due to lower infiltration in soil. The MFRV of digested plant-based manures was in the same range as digested cattle slurries, 73-77% after injection and only 43-57% after surface-banding of the manure.

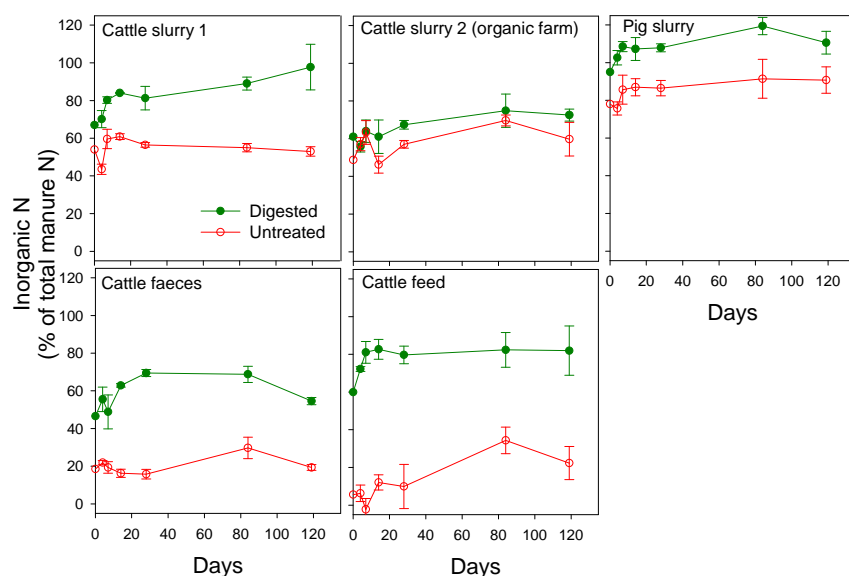

Figure 1. Incubation experiment: Net release of inorganic N in soil after application of digested and corresponding undigested manures. Bars indicate standard errors (n=3).

Table 1. Field experiment: Chemical composition of digestates and corresponding untreated manures. Mineral fertilizer replacement values (MFRV) were measured after injection in spring barley and surface-banding in winter wheat (n=4).

Manure	Total N	NH ₄ -N/total N	DM	pH	MFRV	
	kg N/t	%			Spring barley % of total N	Winter wheat % of total N
Cattle slurry 1	3.00	54	6.43	6.72	75	37
Cattle slurry 1 digestate	3.05	67	4.82	7.52	82	38
Cattle slurry 2 (organic farm)	2.92	49	6.95	8.17	58	30
Cattle slurry 2 digestate	2.94	61	4.65	8.09	69	49
Pig slurry	2.81	78	3.45	7.71	91	75
Pig slurry digestate	2.57	95	1.46	8.4	89	87
Clover-grass digestate	4.53	61	5.18	7.81	73	57
Lupine digestate	2.78	68	3.5	7.71	73	48
Triticale-vetch digestate	2.69	59	5.25	7.48	77	43
LSD (P<0.05)	-	-	-	-	14	19

4. Conclusion

After AD of pig and cattle slurry the increase in potential plant availability was equivalent to 10-25% of total manure N. AD of cattle faeces and a mixed cattle diet increased the net mineral N release in soil even more to about 60 and 80% of total N, respectively. The present results indicate that the plant availability of N of digested plant materials is similar to that of digested cattle slurry. After surface-banding of digested manures rich in fibers, such as cattle and plant-based manures, significant ammonia loss can be expected resulting in relatively poor utilization of manure N.

References

- Møller, H.B., Nielsen, A.M., Nakakubo, R. and Olsen, H.J. 2007. Process performance of biogas digesters incorporating pre-separated manure. *Livestock Science* 112, 217-223.
- Sørensen, P. and Eriksen, J. 2009. Effects of slurry acidification with sulfuric acid combined with aeration on the turnover and plant availability of nitrogen. *Agric. Ecosyst. Environ.* 131, 240-246.

Effects of arbuscular mycorrhizal symbiosis on the nitrogen uptake of three durum wheat genotypes from two different organic sources

Saia, S.^a, Ruisi, P.^a, García-Garrido, J.M.^b, Amato, G.^a, Giambalvo, D.^a

^aDipartimento dei Sistemi Agro-Ambientali, Università degli Studi di Palermo, Palermo, Italy

^bDepartamento de Microbiología, Estación Experimental de Zaidín, CSIC, Granada, Spain

1. Background & Objectives

Arbuscular mycorrhizal (AM) fungi are obligate symbionts of the majority of terrestrial plants. By enhancing nutrient and water uptake, AM symbiosis improves the host plant's growth, nutrient status, and response to biotic and abiotic stress. The role of AM fungi in nitrogen (N) acquisition remains unclear. Although several studies have shown that AM symbiosis enhances N uptake from inorganic sources (Cliquet et al., 1997), its effects on N uptake from organic sources remains unclear, particularly when both AM hyphae and plant roots can utilize the same source (Hodge, 2003; Hodge et al., 2000). These disparate results may result from the different plant species and genotypes used in the experiments, as well as the type and complexity of the added organic material (e.g., the carbon:nitrogen ratio), the different AM fungus species and strains, and the amount and quality of the bacterial populations. The present study tested the hypothesis that AM symbiosis enhances the N uptake of durum wheat (*Triticum durum*) from organic sources and examined whether N uptake varies with the type of organic material and the wheat genotype.

2. Materials & Methods

A pot experiment was conducted in a climate-controlled glasshouse (25/19°C day/night temperature; 16 h photoperiod). A complete randomized factorial design with four replicates was adopted. Treatments were: i) AM symbiosis, inoculation with *Glomus mosseae* (+Myc) and uninoculated control (-Myc); ii) organic matter (OM), the addition of 4.6 g ¹⁵N-enriched maize biomass per kg of soil in the form of maize leaves (+ML: 1.90% N content, 4.78 ¹⁵N atom%) or maize roots (+MR: 1.56% N content, 3.94 ¹⁵N atom%); and iii) wheat genotype, Cappelli (an old Italian cultivar), Scorsonera (a Sicilian landrace), and Simeto (the most widely grown cultivar in Italy). Each pot was filled with 600 g of a quartz sand:soil mixture (2:1). Soil properties were: clay 20% and sand 37%; pH 8.1 (soil:water 1:2); 1.04% organic C; 1.05‰ total N. The soil mixture was steam-sterilised. Before starting the experiment, a soil filtrate was inoculated to normalise the microbial community. Three wheat plants per pot were grown. During the experiment, each pot received 5 ml of a modified Hoagland's solution (with no phosphorus and 10% N) once every 5 days. The dry weights of wheat shoots and roots were recorded 9 weeks after the emergence of the crop and both fractions were analyzed for total N and ¹⁵N enrichment using an elemental analyzer–isotope ratio mass spectrometer. Wheat roots were stained with 0.05% trypan blue in lactic acid and AM infection was measured using the grid intersect method (Giovannetti and Mosse, 1980). The recovery of the applied ¹⁵N in wheat was calculated according to Allen et al. (2004). An analysis of variance was performed according to the experimental design.

3. Results & Discussion

No AM root infection was observed in the -Myc treatment. In the +Myc treatment, AM root infection varied weakly but significantly with the genotype (Simeto > Scorsonera = Cappelli) and with the type of organic matter (+ML > +MR) added (Table 1). Inoculation with AM fungi (+Myc treatment) significantly increased both plant growth and total N uptake compared to -Myc treatments (+15% and +22%, respectively). However, AM inoculation significantly decreased the

fraction of ^{15}N recovered from the added OM (–34% on average compared to –Myc) with differences among the genotypes but not between +ML and +MR. This decrease was lower in Cappelli and Scorsonera than in Simeto. Moreover, the latter genotype showed the highest ^{15}N recovery fraction when grown without AM symbiosis and the lowest benefit of AM symbiosis in terms of total N uptake. The lower fraction of ^{15}N recovered from the added OM (independently from the type of OM) observed in +Myc treatments is difficult to explain but may depend on the capacity of the fungus to take up N from decomposing OM in the form of amino acids and other products. Thus, fungal uptake of dissolved organic N is greater than host plant uptake (Rains and Bledsoe, 2007); the fungus could utilize this element primarily for its own growth and metabolism.

Table 1. Effects of AM symbiosis (AMS) on total biomass, total N uptake, ^{15}N recovery fraction from added OM, and AM root infection according to wheat genotype and the type of organic matter added.

Organic matter (OM)	Genotype (G)	Total biomass [g per pot]		Total N uptake [mg per pot]		^{15}N recovery fraction [%]		AM root infection ^{a)} [%]
		–Myc	+Myc	–Myc	+Myc	–Myc	+Myc	+Myc
+Maize leaves	Cappelli	0.90	1.06	6.86	9.44	5.45	3.88	28.40
	Scorsonera	0.87	1.04	7.67	10.24	5.45	4.32	31.00
	Simeto	0.79	1.01	7.68	9.03	6.36	3.93	35.10
+Maize roots	Cappelli	0.81	0.77	5.88	6.75	5.22	3.68	27.80
	Scorsonera	0.72	0.98	5.04	6.74	4.42	2.88	28.10
	Simeto	0.76	0.71	7.05	6.91	6.37	3.26	34.50
	AMS		***		***		***	–
	OM		***		***		***	***
	G		***		ns		*	***
F test ^{b)}	AMS × OM		***		***		ns	–
	AMS × G		***		*		*	–
	OM × G		ns		***		ns	*
	AMS × OM × G		***		ns		ns	–

^{a)} not applicable to –Myc treatments; ^{b)} ns = not significant; * and *** significant for $P < 0.05$ and 0.001 , respectively.

4. Conclusion

Our results show that AM symbiosis benefits the host plant in terms of both growth and total N uptake. Further analyses of the N content and the relative ^{15}N concentration of the AM extra-radical mycelium are needed to elucidate the complex symbiotic relationships between plants and fungi and their influence on the acquisition of N from different sources.

References

- Allen S.C., Jose S., Nair P.K.R., Brecke B.J. and Ramsey C.L. 2004. Competition for ^{15}N -labeled fertilizer in a pecan (*Carya illinoensis* K Koch)-cotton (*Gossypium hirsutum* L) alley cropping system in the southern United States. *Plant and Soil* 263, 151-164.
- Cliquet J.B., Murray P.J. and Boucaud J. 1997. Effect of the arbuscular mycorrhizal fungus *Glomus fasciculatum* on the uptake of amino nitrogen by *Lolium perenne*. *New Phytologist* 137, 345-349.
- Giovannetti M. and Mosse B. 1980. An evaluation of techniques for measuring vesicular-arbuscular mycorrhizal infection roots. *New Phytologist* 84, 489-500.
- Hodge A. 2003. N capture by *Plantago lanceolata* and *Brassica napus* from organic material – the influence of spatial dispersion, plant competition and an arbuscular mycorrhizal fungus. *Journal of Experimental Botany* 54, 2331–2342.
- Hodge A., Robinson D. and Fitter A.H. 2000. An arbuscular mycorrhizal inoculum enhances root proliferation in, but not nitrogen capture from, nutrient-rich patches in soil. *New Phytologist* 145, 575-584.
- Rains K.C. and Bledsoe C.S. 2007. Rapid uptake of ^{15}N -ammonium and ^{13}C - glycine, ^{15}N by arbuscular and ericoid mycorrhizal plants native to a Northern California coastal pygmy forest. *Soil Biology and Biochemistry* 39, 1078-1086.

Effects of integrated weed management in cropping systems on soils, microbial activity and N₂O fluxes

Vermue, A.^a, Philippot, L.^b, Munier-Jolain N.^a, Bizouard, F.^b, Bru, D.^b, Coffin A.^a, Hénault, C.^c, Nicolardot, B.^a

^aUMR 1210 Biologie et Gestion des Adventices, INRA-AgroSup Dijon-UB, Dijon, France

^bUMR 1229 Microbiologie et Science du Sol, INRA-UB, Dijon, France

^cUR 0272 Science du Sol, INRA, Orléans, France

1. Background & Objectives

Cultivated soils have been widely highlighted as a major source of nitrous oxide (N₂O) emissions. This suggests that greenhouse gas emissions should be taken in account when evaluating the impact of new cropping systems. The development of integrated weed management in cropping systems introduces new agricultural practices (combinations of crop rotation, soil management, fertilization, and mechanical and chemical weed control, etc.), which may affect the microbial processes responsible for N₂O production in soils. However, the effect of those practices remains to be assessed. Thus, the main objectives of our study is to provide (i) an accurate estimation of the intensity of N₂O emissions from an integrated weed management system and (ii) a monitoring of soil chemical, physical, and biological parameters likely to affect N₂O emissions over one year.

2. Materials & Methods

This study focuses on two 10 year old cropping systems at the experimental site of Dijon-Epoisses (Eastern France). The first is a conventional system (CS) with local practices used for herbicide treatment frequency index and the second is an integrated weed management system (IWM) with halved herbicide treatment frequency index. The soils of both studied plots were described as calcareous clayey soils. Due to the unpredictable nature of N₂O emissions from soils, the study of continuous data series is recommended. Nitrous oxide fluxes were measured using 12 automatic chambers coupled with an IR analyzer (Megatec 46i). The chambers were all setup in both plots in a 25 m radius from the analyzer. Soils water content and temperature were continuously measured using probes (respectively Campbell Scientific TDR CS616 and CS107, respectively). A monthly monitoring of the microbial communities was provided from the analyses of composite samples of 3 sub-samples taken around each chamber at two depths: 0-10 cm and 10-30 cm. The sizes of denitrifier, ammonia-oxidizing and total communities were assessed by quantitative PCR of selected genes (respectively *nirK*, *nirS*, *nosZ*; bacterial and crenarchaeal *amoA*, and 16S rRNA). These composite samples were also used for the determination of inorganic N soil contents by KCl extraction and colorimetric analyses. Data were statistically analysed using two-way ANOVA.

3. Results & Discussion

N₂O fluxes ranged between a flux of -6 to 26 g N-N₂O ha⁻¹ day⁻¹ (Figure 1). Emissions were low during the measuring period with respective medians of 0 and 0.45 g N-N₂O ha⁻¹ day⁻¹ for the IWM and CS systems. This may be explained by relatively low soil water content which ranged over the study period from 9 to 24 % (mean 15% dry soil) for the top 30 cm soil layer. Without rainfall, soils consumed rather than produced N₂O. However, after major rainfall events, significant N₂O emissions were observed. Finally over the measurement period, a net production of N₂O was recorded on both plots, with average emissions of 2.8 and 1.6 g N-N₂O ha⁻¹ day⁻¹ for the CS and IWM systems, N₂O emissions from the CS system were significantly higher (P < 0.001).

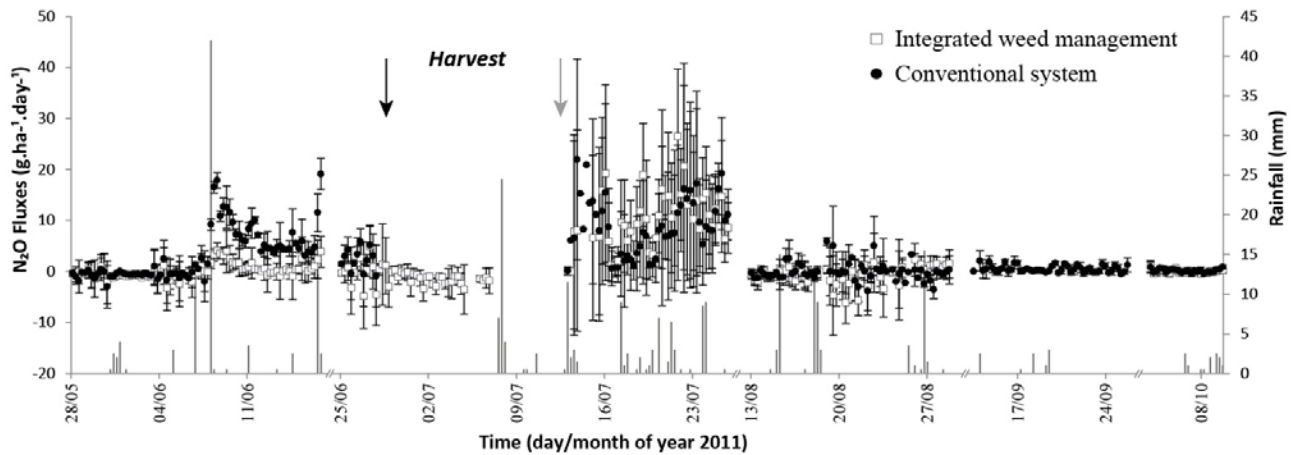

Figure 1. Mean N₂O fluxes per system and 6 hours from integrated weed management and conventional systems. Rainfall histogram corresponds to the sum of precipitation on the last 6 hours and arrows indicate crop harvest dates.

In contrast to the N₂O emissions, the temporal variability of the abundances of both the denitrifying and ammonia-oxidizing communities was very low between May and July. The *nirK* and *nirS* gene copy numbers, which were used as proxies for the abundance of the denitrifiers, ranged between 3.9×10^7 to 2.5×10^8 copies per gram of dry soil. The abundance of crenarchaeal ammonia-oxidizers was in the same range while bacterial ammonia-oxidizers were less numerous with about 2.5×10^5 to 2.8×10^6 gene copies per gram of dry soil. The abundance of bacterial ammonia-oxidizers was also more affected by the management system than the other microbial guilds, especially in July when the highest N₂O emissions were observed.

4. Conclusion

This work highlights the potential impacts of new agricultural practices on greenhouse gas emissions with an original approach, which consists in continuous N₂O fluxes measurements on site coupled with a long-term monitoring of microbial communities and soils parameters.

Effects of new catch crop and tillage systems on nitrogen management in sugar beet production

Stavridou, E.^a, Nielsen, O.^b, Kristensen, H.L.^a

^aDepartment of Food Science, Aarhus University, Denmark

^bNBR Nordic Beet Research, Denmark

1. Background & Objectives

Tillage and autumn catch crops are two management practices that can influence the nitrogen (N) dynamics and yields of row crop production systems. Catch crops take up N during the autumn and may decrease N losses from agro-ecosystems with benefits for the environment (Kristensen and Thorup-Kristensen, 2004). Tillage treatments may influence N transformations and flows in the soil. Moreover, tillage is important for sugar beet growth, yield and quality (Jabro et al., 2010). The objective of this study was to investigate the effects of new combined catch crop and tillage systems on i) soil N content and ii) the growth and N uptake of a subsequent sugar beet crop.

2. Materials & Methods

A two year field experiment comprising six catch crop-tillage treatments were arranged randomly in a split plot design with four replicate blocks with tillage as the main factor giving a total of 24 plots. White mustard (*Sinapis alba* L. "Accent") was used as the catch crop. The experiment was located at Halsted (54°50'N, 11°13'E), West Lolland, Denmark on a sandy loam soil.

The tillage methods in combination with white mustard tested were: (i) strip tillage in September, where the catch crops were incorporated in the rows where sugar beets were going to grow in spring; (ii) reduced tillage, where sugar beet was sown directly in spring where catch crops grew during the winter season; (iii) early ploughing and incorporation of catch crops in September, which is the standard time of ploughing; (iv) late ploughing and incorporation of catch crops in November; (v) autumn ridges, where catch crops grew between them during the winter season. The strip tillage and autumn ridge treatments had only half the stand of white mustard compared to the reduced, early and late ploughing treatments. In addition, (vi) a control treatment without catch crop and with late ploughing was included.

Soil was sampled three times (September, December, March) in 0.25 and 0.50 m depth intervals to 2 m depth, extracted by 1 M KCl, and analysed for content of NH_4^+ and NO_3^- by continuous flow analysis. Root growth of catch crops was registered by use of minirhizotrons of 1.5 m length every two weeks starting four weeks after sowing. (Kristensen and Thorup-Kristensen, 2004). Biomass and N content of catch crops and sugar beets as well as sugar content of sugar beets were evaluated by the GLM procedure of the SAS statistical package.

3. Results & Discussion

Tillage treatments did not affect the root growth of mustard during autumn and early spring. The root growth of white mustard continued in all treatments in deep soil layers during winter. White mustard reduced soil N content in both experimental years in September (data not shown). In December and March, the early ploughing and control treatments resulted in higher soil N content compared to the other catch crop and tillage treatments in the 0.5-1 m soil layer (Figure 1). The strip tillage and autumn ridge treatments were as effective as the late ploughing treatment for reduction of soil N content despite only half the stand of white mustard in the strip and autumn ridge treatments. The root yield of the sugar beet, N uptake and sugar yield were unaffected by the treatments despite the differences in N availability. However, the N content of the sugar beet shoot was higher after the early ploughing and

control treatments, which indicated a higher N availability in the deep soil layers for the sugar beets in these treatments.

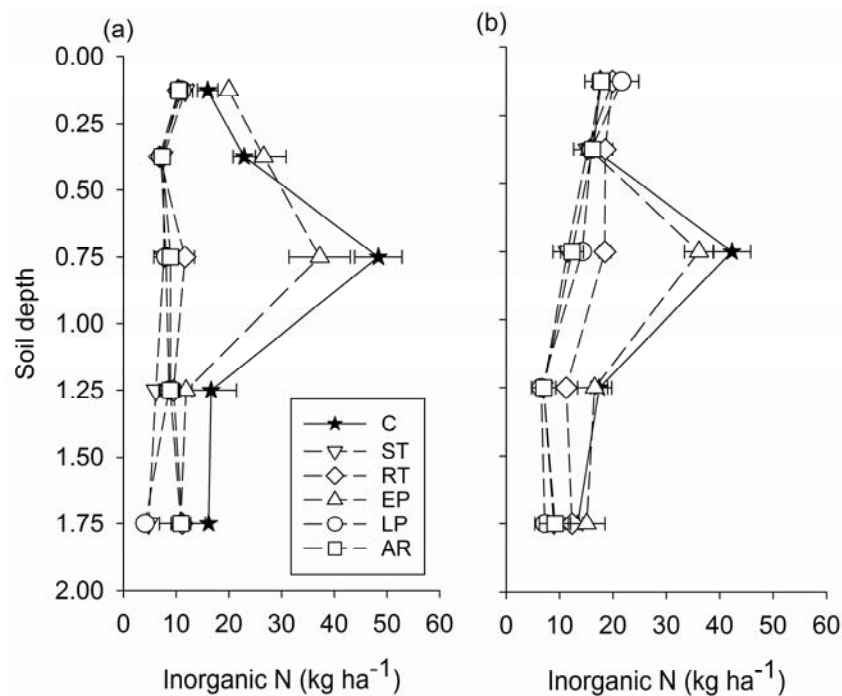

Figure 1. The inorganic N content (NH_4^+ and NO_3^-) in the 2 m soil profile in (a) December and (b) March 2008/09. Bars show standard errors ($n=4$). C: control; ST: strip tillage; RT: reduced tillage; EP: early ploughing; LP: late ploughing; AR: autumn ridges.

4. Conclusion

New combined catch crop and tillage systems, such as strip tillage and autumn ridges, can efficiently reduce the potential N leaching without influencing the yield and quality of the sugar beet root. Early ploughing may increase N leaching and spring N availability as catch crops can take up N only for a short period and then start mineralising after the early incorporation.

Acknowledgements

This study was funded by the Danish Food Industry Agency, the Nordic Beet Research and the Department of Food Science, Aarhus University.

References

- Jabro J.D., Stevens W.B., Iversen W.M. and Evans R.G. 2010. Tillage depth effects on soil physical properties, sugarbeet yield, and sugarbeet quality. *Communications in Soil Science and Plant Analysis* 41, 908-916.
- Kristensen H.L. and Thorup-Kristensen K. 2004. Root growth and nitrate uptake of three different catch crops in deep soil layers. *Soil Science Society of America Journal* 68, 529-537.

Effects of overwinter vegetation cover on soil nitrogen supply to spring barley in Ireland

Hackett, R.

Teagasc, Oak Park Crops Research, Carlow, Rep. of Ireland

1. Background & Objectives

Vegetative cover established after harvest of a cash crop, either by natural regeneration or by sowing a cover crop, and allowed grow over the fallow period, can significantly reduce nitrate leaching by accumulating nitrogen in their biomass (Hooker et al., 2008). When incorporated into the soil before sowing of the next cash crop the accumulated nitrogen can potentially become available to the succeeding crop, thereby reducing the need for fertiliser N applications. Repeated use of cover crops may lead to an increase in soil organic nitrogen which in turn can lead to an increase in soil supply of nitrogen to succeeding cash crops over time (Constantin et al., 2011). A long-term experiment was established to examine the effect of repeated use of different overwinter covers under two cultivation regimes on the amount of nitrate leaching and on productivity of the cash crop. The objective of the current work was to determine effects of different over winter covers, established repeatedly, after 5 to 9 years on the supply of soil nitrogen to a spring barley crop under Irish conditions.

2. Materials & Methods

The experiment was initiated in autumn 2002 and the results presented here are from measurements made in 2007 to 2010. The experiment has previously been described by (Hooker et al., 2008). Briefly a factorial design with two factors and four replicates was used. The factors were overwinter cover (no vegetation cover, natural regeneration, white mustard cover crop) and cultivation type (plough based tillage, reduced tillage). For the plough based system the soil was not disturbed following harvest except for minimal disturbance of the soil surface during sowing of the mustard seed. For the reduced tillage treatments cultivation occurred soon after harvest of the spring barley crop. The bare treatment was maintained free of vegetation using non-selective herbicide. The natural regeneration treatment comprised any plants germinating following harvest of the previous spring barley crop. The mustard cover crop was established by planting white mustard seed (*Sinapsis alba*) at 10-12 kg seed/ha. In each season any vegetation present on the plots was incorporated into the soil by ploughing on the plough treatments. In the reduced tillage treatment the barley was drilled without prior cultivation such that the majority of the vegetation remained on the surface of the soil. The experiment was carried out on a light free draining soil. Overall plot size was 12 m x 30 m but within each plot a different 2 m x 2 m area was maintained free of fertiliser N in each season but received all other inputs as per standard practice. At crop maturity the barley from an area of 0.5 m² at the centre of this area was sampled to ground level. Total crop N accumulation (grain + straw) and grain N accumulation were determined. Results were analysed using ANOVA.

3. Results & Discussion

Total crop N uptake was taken as a measure of soil nitrogen supply to the crop. A significant effect of cultivation method was detected in 2008 when reduced cultivation had significantly greater crop N accumulation and grain N accumulation than the plough based system. There was no significant interaction between cultivation method and overwinter cover in any season for either of the variables. Therefore means of overwinter cover across cultivation method are presented (Table 1).

Overwinter cover had a significant effect on crop N accumulation in 2007, 2008 and 2010 but not in 2009. In the three seasons where a significant effect of overwinter cover was detected the mustard gave a significantly higher crop N accumulation and grain N accumulation compared to both the bare and natural regeneration treatment. There was no significant difference in crop N accumulation between the natural vegetation treatment and the bare treatment in 2007 and 2010, the natural regeneration treatment had higher crop N accumulation than bare in 2008. The mustard treatment increased crop N accumulation by 36.6%, 59.5%, 18.5% and 44.0% compared to the bare treatment for 2007, 2008, 2009 and 2010 respectively. Mustard increased crop N accumulation by 36.2%, 36.4%, 2.8%, and 22.4% in the respective seasons compared to the natural regeneration treatment. In each season where a significant effect was detected over 70% of treatment differences in crop N accumulation were accounted for by differences in grain N accumulation.

These results indicate that the presence of overwinter vegetation can increase soil N supply to spring barley. However, compared to the normal fertiliser N requirement of spring barley of 13.5 g N m⁻² (Coulter et al., 2008) the benefits of overwinter vegetation on nitrogen supply to the crop appear small. In addition these amounts are low compared to the reductions in N leaching of 26-60 kg N ha⁻¹ where mustard was grown compared to bare fallow recorded previously at this site (Hooker et al., 2008). The inconsistency of the effect makes adjustment of fertiliser N additions to take account of the increased soil N supply difficult.

Table 1. Effects of over winter cover type on crop N accumulation and grain N accumulation over four seasons at Oak Park, Carlow, Ireland.

	Crop N (g N m ²)				Grain N (g N m ²)			
	2007	2008	2009	2010	2007	2008	2009	2010
Mustard	4.18	5.47	3.33	3.99	2.80	3.88	2.20	3.01
NR	3.07	4.01	3.24	3.26	2.00	2.77	2.19	2.40
Bare	3.06	3.43	2.81	2.77	1.99	2.42	1.77	2.10
SED	0.314	0.278	0.345	0.330	0.291	0.207	0.262	0.245
P value	0.004	<0.001	ns	0.007	0.021	<0.001	ns	0.007

4. Conclusion

This work highlights that the presence of overwinter vegetation on land destined for spring barley cultivation can increase the supply of nitrogen to succeeding crops of spring barley but the effect is relatively small and inconsistent. This makes reductions in fertiliser inputs as a result of cover crop use difficult to justify. Furthermore it is not clear if the effects of overwinter cover would be evident where fertiliser N was applied.

References

- Constantin, J., Beaudoin, N., Laurent, F., Cohan, J.P., Duyme, F. and Mary, B. 2011. Cumulative effects of catch crops on nitrogen uptake, leaching and net mineralisation. *Plant and soil* 341, 137-154.
- Coulter B. and Lalor S. (eds.). 2008. Major and micro nutrient advice for productive agricultural crops, third edition. Teagasc, Johnstown Castle, Wexford, Ireland.
- Hooker, K.V., Coxon, C.E., Hackett, R., Kirwan, L. and Richards, K. 2008. Evaluation of cover crop and reduced cultivation for reducing nitrate leaching in Ireland. *Journal of Environmental Quality* 37, 138-145

Effects of soil inoculation with arbuscular mycorrhizal fungi on plant growth and nutrient uptake of some Mediterranean species grown under rainfed field conditions

Saia, S., Ruisi, P., Amato, G., Di Miceli, G., Frenda, A.S., Giambalvo, D.
Dipartimento dei Sistemi Agro-Ambientali, Università degli Studi di Palermo, Italy

1. Background & Objectives

Low-input farming systems often suffer nutrient deficits that limit plant performance. The symbiosis between plants and arbuscular mycorrhizal (AM) fungi efficiently promotes plant growth and nutrient uptake, especially in growth-limiting environments (Smith and Read, 2008). AM symbiosis seems to be particularly efficient for the acquisition of low-mobility nutrients such as phosphorus (P), magnesium, and zinc, although it traditionally has been considered irrelevant for plant nitrogen (N) nutrition. However, there is increasing evidence that AM symbiosis plays a significant role in plant N capture, especially under conditions of stress (such as water and nutrient stress). These benefits mainly have been observed in pot studies; field studies have often produced contradictory results (Kaschuk et al., 2010). The present work evaluated the effect of a multi-species AM fungi soil inoculum on the biomass uptake of P and N in two cereals, oat (*Avena sativa*) and barley (*Hordeum vulgare*), and two legumes, lentil (*Lens culinaris*) and fenugreek (*Trigonella foenum graecum*), all grown in the field.

2. Materials & Methods

A field trial was conducted under rainfed conditions at Pietranera farm, Sicily, Italy (37°33'N – 13°30'E, 170 m a.s.l.), on a Vertic Haploxerept. The topsoil (0–40 cm) characteristics were: clay 50%, silt 23%, sand 27%; pH 8.0 (1:2 H₂O); 1.27% organic matter; 83 ppm available P; and 0.76‰ total N. The climate of the experimental site is semiarid Mediterranean. The experimental design was a split plot with four replicates. The main treatment was plant species: oat, barley, lentil, and fenugreek. The sub-plot treatment was soil inoculation: the application of a commercial inoculum containing nine species of AM fungi and non-inoculated soil. The previous crop was durum wheat (*Triticum durum*). In the first week of December 2010 all crops were sown using the seed rate for each plant species that is usually adopted by farmers in the growing environment. No fertilizer was applied and all plots were hand-weeded during the entire crop cycle. In the first week of May 2011, all crops were cut to 2-cm stubble height. Total fresh and dry weights were determined and a sub-sample was taken and analyzed for total N and P. Root samples were also collected and stained with 0.05% trypan blue in lactic acid. The percentage of root AM infection was measured according to Giovannetti and Mosse (1980). An analysis of variance was performed according to the experimental design.

3. Results & Discussion

On average, the addition of AM fungi inoculum to soil significantly increased biomass production (+14.1%) without affecting P and N concentration, thus producing a significant increase in plant P and N uptake (+8.3% and +12.7% on average, respectively; Table 1). Several studies have shown that AM symbiosis can increase plant P uptake in P-limited environments; although our experiment was performed in P-rich soil, we observed a significant increase in P acquisition by plants. Given the low N availability (a result of both low soil N content and N uptake by the field's prior cereal crop), the observed growth increase in AM-inoculated oat and barley is probably related to increased plant uptake of N as a result of the symbiotic relationship. The effect of AM fungi inoculation on plant N uptake was evident in lentil (+30% compared to the non-inoculated crop),

but not in fenugreek. AM symbiosis may have allowed lentil—a slow-growing and low-yield species that usually suffers abiotic stresses such as nutrient and water deficiency (Materne and Siddique, 2009)—to increase its tolerance to biotic and abiotic stresses. This enhanced plant growth resulted in a higher demand for N, which was satisfied through increased N₂ fixation. Other studies (Saia et al., 2010) have shown that AM fungi positively affect the N₂ fixation of field-grown forage legumes, particularly when grown under drought conditions. We used a genotype of fenugreek that has good tolerance to biotic and abiotic stresses and that gives reasonable yields under low-input cultivation conditions, which may explain why it benefitted less from the AM symbiosis.

Table 1. Effect of arbuscular mycorrhizal (AM) fungi soil inoculation on above-ground biomass, phosphorus (P) and nitrogen (N) concentrations in tissue, and P and N uptake in two cereal and two legume species (S) grown in the field.

Plant species (S)	Soil inoculation with AM fungi (AM)	Biomass	P	P	N	N
		[Mg DM ha ⁻¹]	concentration [%o]	uptake [kg ha ⁻¹]	concentration [%]	uptake [kg ha ⁻¹]
<i>Barley</i>	Inoculated	9.45	1.33	12.6	0.91	86.0
	Non-inoculated	8.45	1.44	12.2	0.85	71.5
<i>Oat</i>	Inoculated	7.93	1.49	11.7	1.10	86.3
	Non-inoculated	6.76	1.59	10.7	1.05	70.6
<i>Lentil</i>	Inoculated	6.06	1.96	11.8	2.47	150.3
	Non-inoculated	4.80	2.11	10.1	2.43	115.6
<i>Fenugreek</i>	Inoculated	7.24	2.11	15.3	2.36	169.4
	Non-inoculated	6.88	2.09	14.5	2.45	168.8
F test ^{a)}	S	*** (0.85) ^{b)}	*** (0.15)	*** (1.8)	*** (0.12)	*** (16.7)
	AM	***	ns	*	ns	*
	S×AM	ns	ns	ns	ns	* (12.4)

^{a)} ns = not significant; * and *** significant for P < 0.05 and 0.001, respectively;

^{b)} Fisher's Protected LSD for P=0.05 are shown in parentheses.

4. Conclusion

Our results show that soil inoculation with AM fungi increases both growth and nutrient uptake in cereal and legume species typical of the Mediterranean environment to varying degrees among species. From a practical point of view, inoculation with AM fungi can be a valuable option for farmers to improve the sustainability of the agro-ecosystem as it is an environmentally friendly approach for the increase of crop nutrient uptake.

References

- Giovannetti M. and Mosse B. 1980. An evaluation of techniques for measuring vesicular-arbuscular mycorrhizal infection roots. *New Phytologist* 84, 489–500.
- Kaschuk G., Leffelaar P.A., Giller K.E., Alberton O., Hungria M. and Kuyper T.W. 2010. Responses of legumes to rhizobia and arbuscular mycorrhizal fungi: A meta-analysis of potential photosynthate limitation of symbioses. *Soil Biology and Biochemistry* 42, 125–127.
- Materne M. and Siddique K.H.M. 2009. Agroecology and Crop Adaptation. In: Erskine W., Muehlbauer F., Sarker A. and Sharma B. (Eds.). *The Lentil. Botany Production and Uses*. CABI, Wallingford, UK pp. 47–63.
- Saia S., Ruisi P., Amato G. and Giambalvo D. 2010. Effects of arbuscular mycorrhizal symbiosis on growth and N₂ fixation of *Trifolium alexandrinum* under late drought-stress conditions. *Grassland in a changing world*, vol. 15, *Grassland Science in Europe*, pp. 842–844.
- Smith S.E. and Read D.J. 2008. *Mycorrhizal symbiosis*. Academic Press, San Diego, CA, USA.

Effects of storage method on N disappearance and herbage N recovery from solid cattle manure

Shah, G.M.^a, Lantinga, E.A.^a

^aOrganic Farming Systems Group, Wageningen University, P.O. Box 563, 6700 AN, Wageningen, The Netherlands

1. Background & Objective

Solid cattle manure is either applied directly from the barn to the field or stored for a certain period of time prior to land spreading. However, it is well-known that up to 50% of total nitrogen (N) can be lost during storage of solid manure (Eghball et al., 1997). This study aimed to examine the effects of two contrasting manure storage methods on N losses during storage and decomposition, N disappearance and herbage N recovery after land-spreading as compared with fresh manure.

2. Materials & Methods

Fresh solid cattle manure (12.5 tonnes fresh wt.) was stored for 130 days in two ways: (i) as a composted heap with infrequent turning and (ii) as a sheeted heap under impermeable plastic cover (anaerobic storage). Total N losses were estimated by comparing their N contents relative to the raw ash fractions before and after storage. Thereafter, ~100 g (fresh wt.) of fresh (FR), composted (CO) and anaerobically stored (AN) manures were filled in litterbags (size 10 cm by 10 cm) of 4 mm mesh size, placed in three replicate blocks on the soil surface of a sandy grassland and removed after 15, 33, 63, 123 and 168 days. At each sampling, the leftover manure in the litterbags was oven-dried at 105°C for 24 hours, weighed, ground to pass a 1 mm sieve and analyzed for total N content. Possible soil contamination of manure in litterbags was estimated as described by Cusick et al. (2006). Manure dry matter (DM) and N disappearance patterns were fitted using the mono-component model developed by Yang and Janssen (2000). In addition, herbage growing up to 15 cm around the litterbags and the controls, which consisted of non-decomposable pieces of wood (size 10 cm * 10 cm), was cut three consecutive times to a stubble height of 1 cm with a spinach knife after 47, 96 and 168 days. This enabled the calculation of the total apparent N recovery (ANR) from each manure type.

3. Results & Discussion

During storage, total N losses were remarkably low from the anaerobic (10% of the initial) compared to that from the composted (46%) heap. Covering of the manure blocks air circulation, inhibits organic matter degradation and lowers internal heat production as well as pH, which ultimately leads to decreased N losses (Kirchmann, 1985). Fractions of manure DM and N that were remaining in the litterbags at each sampling event are presented in Figure 1a and 1b, respectively. For all manures, DM and N disappearance rates were highest over the first 15 days. At the end of the growing season, the degree of manure DM and N disappearance was in the order ($P < 0.01$): AN > FR > CO (Table 1). The increased values for the AN manure can be related to the presence of more readily degradable C and N compounds compared to the other two manures (Kirchmann, 1985). Of the total N disappeared from the litterbags, about 80% was apparently recovered in the aboveground herbage from both the FR and CO manures, whereas this fraction was 90% in the case of AN manure. This could be explained by its relatively higher mineral N content. Note that in this experiment the herbage harvesting height was close to ground level and therefore ANR values were higher than will be obtained by using ordinary cutting machines.

Table 1. Total DM and N disappearances, and ANR from manures at the end of the growing season (day 168). Values in the parenthesis represent standard error of the mean (DM and N disappearance) and proportional figures (ANR).

Manure	DM disappearance	N disappearance	ANR	
			(% of applied N)	(% of produced N)
Fresh	40 (1.64)	51 (2.44)	41	41 (72)
Composted	30 (0.87)	44 (2.29)	35	19 (33)
Anaerobically stored	48 (2.19)	69 (1.09)	63	57 (100)

Overall, a three-fold higher fraction of the produced N in the barn ended up in the harvested herbage from the anaerobically stored manure as compared with the compost treatment (Table 1). This indicates that there is a great scope for the anaerobic storage method regarding N utilization. During the composting process a great deal of the initial manure-N is lost and a relatively large fraction of the remaining N is bound into stable organic N compounds (Kirchmann, 1985).

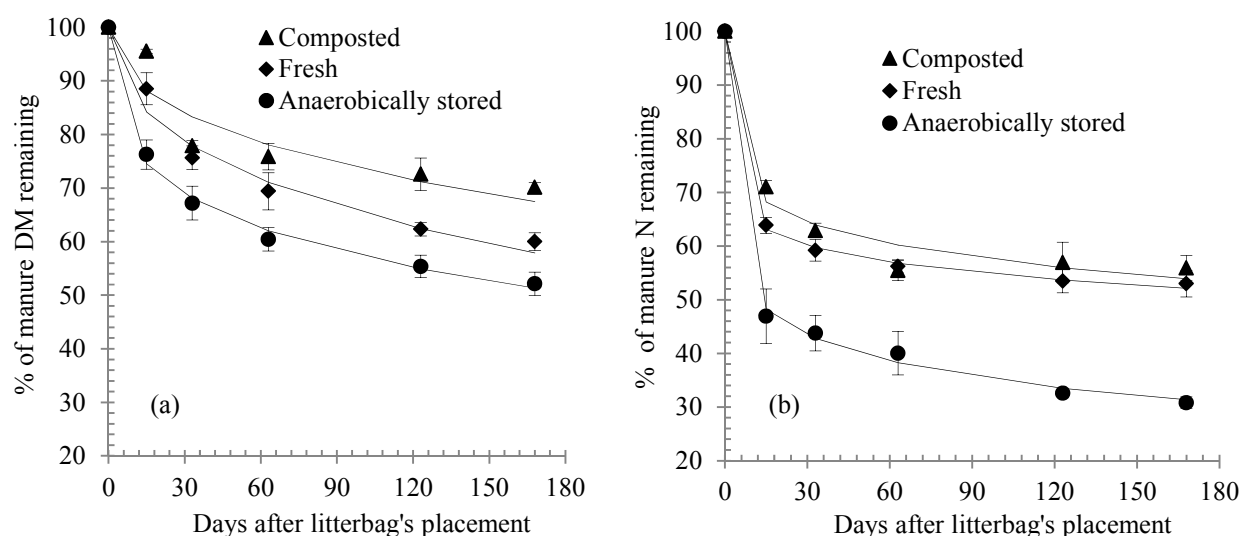

Figure 1. Fractions of total DM (a) and N (b) from solid cattle manures that remained in the litterbags. Discrete points represent the mean values. Error bars depicts standard error (\pm) of the mean. Continuous lines indicate the fitted mono-component model.

4. Conclusions

This study clearly demonstrated that N losses can be markedly reduced (>70%) by anaerobic storage of solid cattle manure. After application, this manure decomposes faster and more N is available for plant uptake compared to fresh and composted manures. This all resulted in a three times higher herbage uptake of the produced manure N relative to the compost treatment.

References

- Cusick, P.R., Powell, J.M., Kelling, K.A., Hensler, R.F. and Muñoz G.R. 2006. Dairy manure N mineralization estimates from incubations and litterbags. *Biology and Fertility of Soils* 43, 145-152.
- Eghball, B., Power, J.F., Gilley, J.E. and Doran, J.W. 1997. Nutrient, carbon, and mass loss during composting of beef cattle feedlot manure. *Journal of Environmental Quality* 26, 189-193.
- Kirchmann, H. 1985. Losses, plant uptake and utilization of manure nitrogen during a production cycle. *Acta Agriculturae Scandinavica Supplementum*, 24, pp. 77.
- Yang, H.S. and Janssen, B.H. 2000. A mono-component model of carbon mineralization with a dynamic rate constant. *European Journal of Soil Science* 51, 517-529.

Effects of urea fertilization with urease and nitrification inhibitors on ammonia volatilization and winter wheat yield

Ni, K., Pacholski, A., Kage, H.

Institute of Crop Science and Plant Breeding, Christian-Albrechts-University, Kiel, Germany

1. Background & Objectives

The worldwide use of urea as nitrogen fertilizer has increased more than four fold since the 1960s, currently accounting for more than 50% of global agricultural nitrogen input (Gilbert et al., 2006). After application, urea nitrogen can be lost through ammonia volatilization. Due to the rising concerns about the economic and environmental impacts of ammonia volatilization, new urea fertilizers, combined with urease or nitrification inhibitors have been developed to reduce ammonia emission or nitrate leaching. Further *in situ* testing is still required to quantify the actual reduction of losses under different soil and weather conditions. Therefore, a field study was carried out under the climatic conditions of Northern Germany to quantify the effects of different urea fertilizers on ammonia emissions as well as N-uptake and yield of winter wheat.

2. Materials & Methods

The field experiment was conducted during the winter wheat season on Hohenschulen experimental farm of Christian-Albrechts-University in Kiel, North Germany in 2011. The treatments consisted of five commercial nitrogen fertilizer products, Calcium ammonium nitrate (CAN), Common granular urea (Piagran 46[®]), urea combined with urease inhibitor (Piazur[®]), urea combined with nitrification inhibitor (Alzon 46[®]), urea combined with urease/nitrification inhibitor with the same nitrogen application rate, 200 kg N ha⁻¹. The application of urea combined with nitrification inhibitors were split in two doses (EC 23, EC 37), and the other fertilizers were applied three times (EC 23, EC 31, EC 49). All treatments were replicated (n = 4). Ammonia emissions were measured in all replications by a calibrated passive sampling method (CPS), a combination of Drager tube method (Pacholski et al., 2006) and standard comparison method (Vandre and Kaupenjohann, 1998). The detailed description and validation of the method is presented in Gericke et al. (2011). Winter wheat biomass and yields were determined by hand harvest (5 rows x 50 cm) before combine harvest in August.

Table 1. Cumulative NH₃ losses during the winter wheat season 2011.

Treatment [†]	Cumulative NH ₃ loss during each application (kg N ha ⁻¹)				Whole season	
	March 21	April 20	May 18	June 1	Total	Ratio (%)
CAN	1.15(0.28)d	1.13(0.16)b		4.23(1.19)b	6.51 (1.22)c	3.26
U	6.69(0.57)b	1.95(0.16)a		10.96(0.65)a	19.6(1.06)b	9.80
U+UI	2.55(0.5)cd	0.83(0.23)b		3.58(0.83)b	6.96(0.44)c	3.48
U+NI	10.14(0.68)a		18.09(1.67)a		28.23(1.52)a	14.12
U+UI+NI	3.37(0.28)c		4.01(0.7)b		7.38(0.82)c	3.69

[†] CAN, U, U+UI, U+NI, U+UI+NI represented Calcium ammonium nitrate, Common granular urea, urea combined with urease inhibitor, urea combined with nitrification inhibitor, urea combined with urease/nitrification inhibitor

* Values in the brackets denoted standard error.

** Different letters represented significant difference at $P < 0.05$, and multiple comparison was carried out by HSD test.

3. Results & Discussion

Ammonia emission accounted for 3.26~14.12% of applied nitrogen. Urease inhibitor significantly reduced, whereas application of urea with nitrification inhibitor significantly increased ammonia emission as compared to conventional urea (Table 1). Urea with urease inhibitor had the same NH₃ emission level as CAN. The ANOVA analysis of the data set

showed a significant interaction effect between urease and nitrification inhibitors on ammonia volatilization. However, due to very dry weather in April and May, NH_3 losses after the 2nd application of urea and urea with urease inhibitor were very low as compared to moister conditions which possibly biased the differences between total NH_3 losses after application of the tested fertilizers. Wheat grain yield varied between 7.85 and 9.01 t ha^{-1} . There was no effect on grain yield between N fertilized treatments under the presented application rate with a tendency of lower yields under higher NH_3 emissions (Figure 1a). However, a significant effect of fertilizer types on N uptake was observed ($\text{CAN}, \text{U+UI}, \text{U+NI+UI} > \text{U}, \text{U+NI} > \text{CK}$). The higher N-uptake in the CAN treatment compared to the urea treatments, even with low NH_3 losses, can probably be accounted for by the higher NO_3^- -N availability under dry soil conditions as compared to NH_4^+ -N, the product of urea hydrolysis. The relationship between NH_3 loss and total nitrogen uptake could be described as a linear equation, which indicates a negative relationship between NH_3 emission and crop nitrogen uptake (Figure 1b).

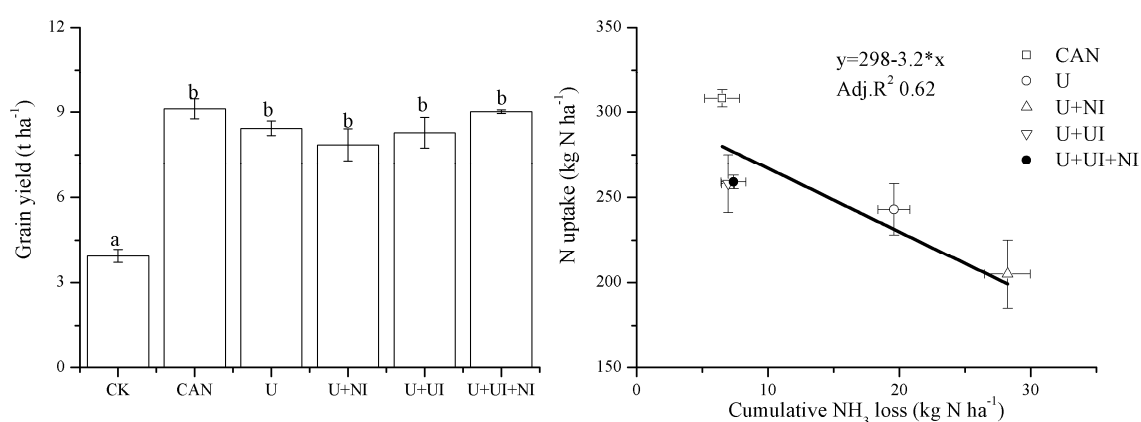

Figure 1. Grain yield (a), and relationship between cumulative NH_3 loss and total nitrogen N uptake (b). Different letters represent significant difference at $P < 0.05$, and multiple comparison was carried out by HSD test

4. Conclusion

Our study showed that the application of urea combined with urease inhibitor significantly reduced NH_3 emissions as compared to conventional urea, whereas nitrification inhibitors alone stimulated ammonia volatilization without significantly decreasing wheat grain yield. These higher emissions as compared to urea without inhibitors can probably be accounted for by different soil and weather conditions at the different application dates. The combined use of urease/nitrification inhibitor applied in only 2 doses showed the lowest NH_3 loss and high grain yield. This was the best economic and environmental result amongst the urea fertilizers treatments, similar or even superior to that of the CAN application (3 doses).

We appreciate the support of this study by SKW Stickstoffwerke Piesteritz GmbH.

References

- Gericke, D., Pacholski, A. and Kage, H. 2011. Measurement of ammonia emissions in multi-plot field experiments. *Biosystems Engineering* 108, 164-173.
- Glibert, P.M., Harrison, J., Heil, C. and Seitzinger, S. 2006. Escalating worldwide use of urea - a global change contributing to coastal eutrophication. *Biogeochemistry* 77, 441-463.
- Pacholski, A., Cai, G.X., Nieder, R., Richter, J., Fan, X.H., Zhu, Z.L. and Roelcke, M. 2006. Calibration of a simple method for determining ammonia volatilization in the field - comparative measurements in Henan Province, China. *Nutrient Cycling in Agroecosystems* 74, 259-273.
- Vandre, R. and Kaupenjohann, M. 1998. In situ measurement of ammonia emissions from organic fertilizers in plot experiments. *Soil Science Society of America Journal* 62, 467-473.

Efficacy of ^{15}N nitrogen in fertilization of mixtures of cereals and pea

Rutkowska, A.

Institute of Soil Science and Plant Cultivation – National Research Institute in Puławy

1. Background & Objectives

Natural farming conditions in Poland are poor, due to prevalence of light, acid soils with low content of available P, K, Mg and unfavorable climate. Thus legume growing in mixtures with cereals is characteristic of Polish agriculture. The purpose of mixing legumes and cereals is to optimize the use of spatial, temporal and physical resources both above- and below ground. However, fertilization of mixtures in order to provide the cereal with nitrogen is questionable since high levels of available N depress atmospheric N fixation by legumes, and can lead to ground water pollution or losses in surface runoff as well as greenhouse gas emissions. The objective of this pot experiment was to determine the efficacy of mineral fertilizers on yield and quality of wheat, barley and oats in mixtures with field peas and estimation of ^{15}N derived from mineral fertilizers by the mixtures under four percentages of peas in mixture: 33, 57, 75 and 88% of cereals.

2. Materials & Methods

Nitrogen fertilizer ($^{15}\text{NH}_4^{15}\text{NO}_3$) was applied at the rates: 0,3, 0,6, 0,9 and 1,2 g N/pot, accordingly to cereal (winter, barley and oats) percentage in the mixtures: 33% (2 cereal plants + 4 pea plants), 57% (4 cereal plants + 3 pea plants), 75% (6 cereal plants + 2 pea plants) and 88% (8 cereal plants + 1 pea plant). Total amount of fertilizers was subdivided into 0.3 g N/pot doses of which the first was applied before sowing and subsequent rates at 10 day intervals. The experiment was conducted in three replicates. After harvest dry mass of above ground biomass was evaluated.

3. Results & Discussion

The highest seed yields of the mixtures were obtained in treatments with a wheat component. However, barley was the least competitive crop for peas (average 52% of the mixture seed yield) in comparison with wheat (60%) and oats (64%). Generally, nitrogen fertilization ensured yield stability, but the highest protein yield was associated with the highest proportion of cereals (Figure 1 – 4).

The quantity of ^{15}N derived from fertilizers by cereals – peas mixtures increased together with N rate (or cereal contribution in the mixture) and amounted to 16% to 58% of total N taken up by the mixtures. The oats – pea mixture took up the lowest amount of total nitrogen but recovered the highest quantity of ^{15}N from fertilizers. In treatment 0,3g N/pot, N biologically fixed by pea plants and N from soil, taken up by wheat-peas mixture reached 1,28 g, by barley-peas mixture -1,60 g and by oats – peas one – 1,19 g. Respectively, in treatment 1,2 g N/pot, the extra N consisted 0,7 g on the average (Figure 5 – 8).

4. Conclusions

Nitrogen fertilization at the rates fitted to cereal proportion in the mixture ensured yield stability, however, in respect of protein yield (with except of wheat) the most beneficial mixture composition was 33% cereal plants and 67 % peas. The coefficient of ^{15}N utilization by the mixtures (including root mass) was very high, decreasing through the N rates and ranging from 92 (0,3 g N/pot) to 76% (1,2 g N/pot).

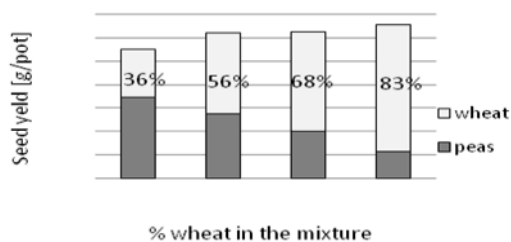

Figure 1. Seed yield of wheat - pea mixture

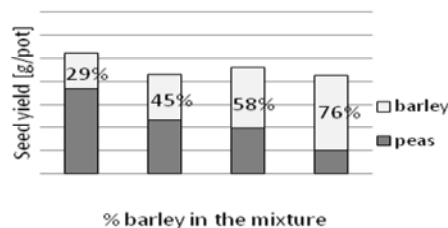

Figure 2. Seed yield of barley - pea mixture

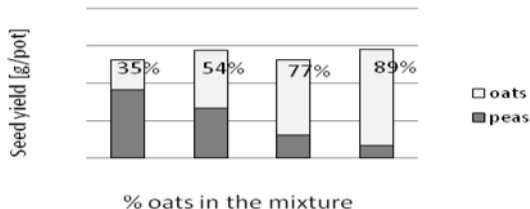

Figure 3. Seed yield of oat - pea mixture

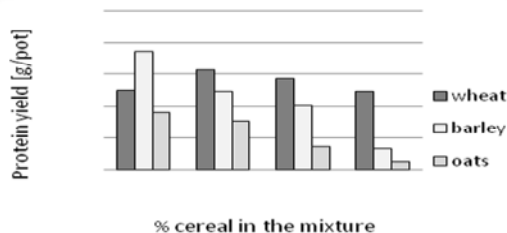

Figure 4. Protein yield of cereal - pea mixture

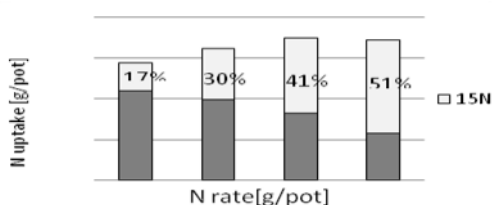

Figure 5. Uptake of total N and ¹⁵N by barley – pea mixture

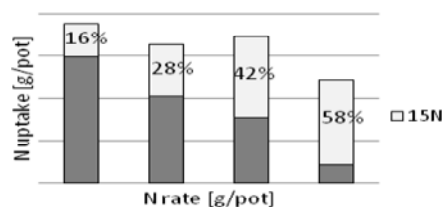

Figure 6. Uptake of total N and ¹⁵N by wheat – pea mixture

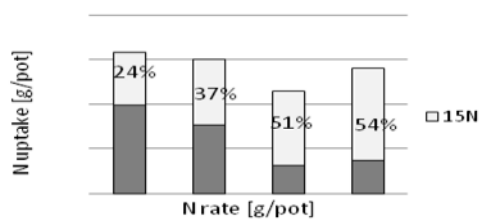

Figure 7. Uptake of total N and ¹⁵N by oat – pea mixture

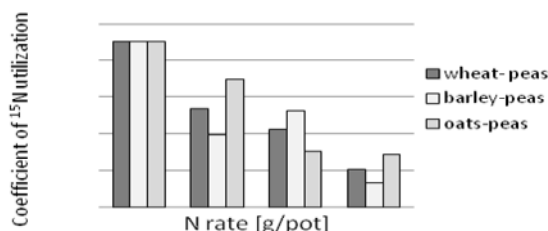

Figure 8. Utilization of ¹⁵N by barley – pea mixture

References

- Hardarson, G, Danso, S.K.A., Zapata, F. and Reichardt, K. 1991. Measurements of nitrogen fixation in fababeans at different N fertilizer rates using ¹⁵N isotope dilution and “A- value” methods. *Plant Soil* 131, 161-168.
- Lauk, R. and Lauk, E. 2008. Pea-oat intercrops are superior to pea-wheat and pea-barley intercrops. *Acta Agriculturae Scandinavica, Section B - Soil & Plant Science* 58 (2), 139-144.
- Noworolnik, K. and Dworakowski, T. 2010. Yield of barley, pea and oat-pea mixtures depending on nitrogen rate and soil condition. *Acta Scientiarum Polonica, Agricultura* 9(3), 53-60.
- Papastylianou, I. 1990. Response of pure stands and mixtures of cereals and legumes to nitrogen fertilization and residual effect on subsequent barley. *The Journal of Agriculture Science* 115, 15-22.
- Zapata, F., Danso, S. K. A. and Hardarson, G. 1987. Time course of nitrogen fixation in field-grown soybean using nitrogen – 15 methodology. *Agronomy Journal* 79, 172-176

Emissions of ammonia and nitrous oxide from liquid and solid fractions of treated pig slurry

Velthof, G.L.^a, Hummelink, E^a, Oenema, O.^a

^aAlterra, Part of Wageningen UR, P.O. Box 47, 6700 AA Wageningen, The Netherlands

1. Background & Objectives

Processing of animal slurry is an opportunity to improve nitrogen (N) use efficiency of manure applied to crops. Separation of slurry into liquid and solid fractions, and further treatment of the liquid fraction using reverse osmosis results in a mineral concentrate which may have similar properties as a mineral N fertilizer (Velthof, 2011). A mineral concentrate is a liquid ammonium fertilizer (ammonium content is on average 90% of total N) with a high pH (>7.5). The combination of a high ammonium content and high pH increases the risk of ammonia (NH₃) emissions. The risk of NH₃ emissions can be decreased by application with a low NH₃ emission technique. However, these application techniques may increase nitrous oxide (N₂O) emission (Velthof and Mosquera, 2011). In a series of incubation studies, the NH₃ and N₂O emissions from untreated pig slurry, mineral concentrate, and the solid fraction from separated slurry were quantified. The products were both surface applied and injected.

2. Materials & Methods

Two experiments were conducted using incubation bottles with sandy soils without crop, and one experiment was carried using cores from grassland on sand, clay, and peat soils (PVC cylinders of 10 cm diameter and 10 cm depth). The first two experiments included different types of fertilizer (calcium ammonium nitrate (CAN), urea, urean (not shown in this abstract), four pig slurries, four mineral concentrates, and four solid fractions, and two application techniques (surface application and incorporation through the soil and were carried out in three replicates (in total 93 incubation bottles in each experiment). The grassland experiment included the same fertilizer types as the experiment with uncropped soil, except solid fractions. All fertilizers were incorporated in the grassland soil to 5 cm depth experiment (in total 108 cores; 36 per soil type). Fluxes of NH₃ and N₂O were assessed from the increase in NH₃ and N₂O concentrations in the headspace of the incubation bottles or flux chambers following closure. Concentrations of NH₃ and N₂O were measured 8 - 12 times during incubation, using a Innova photo-acoustic gas analyzer.

3. Results & Discussion

The emissions of NH₃ increased immediately after application of slurry, mineral concentrate, solid fraction and urea, and decreased thereafter. The NH₃ emissions were much higher after surface application than after incorporation (Figure 1). Total NH₃ emissions from mineral concentrate were on average similar to that from pig slurry, at the same total N application rate. The N₂O emissions from mineral concentrate increased just after application (up to a factor 3000), and decreased thereafter. Incorporation of all slurries, treated slurries and mineral N fertilizers increased N₂O emission in comparison to surface application. On average, the N₂O emissions were about a factor 1.5 higher from mineral concentrate than from untreated slurry (Figure 2) and from CAN. Mineral concentrates contain degradable organic carbon compounds which may have increased denitrification (Paul and Beauchamp, 1989). High NH₃ concentrations in the soil after application of mineral concentrates may inhibit nitrification and, thereby increase N₂O emissions. These effects are likely to be similar as those found in urine patches (Oenema et al., 1997). Acidification and/or removal of organic carbon from mineral concentrates may be measures to decrease N₂O emissions from mineral concentrates.

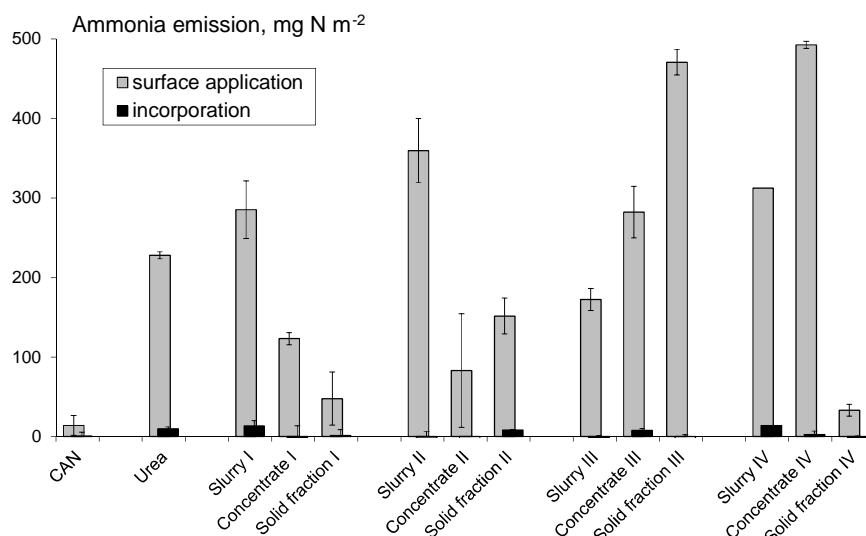

Figure 1. Total NH_3 emission (average \pm s.e.) in experiment I (arable soil). The roman numerals indicate the four different slurries, concentrates and solid fractions).

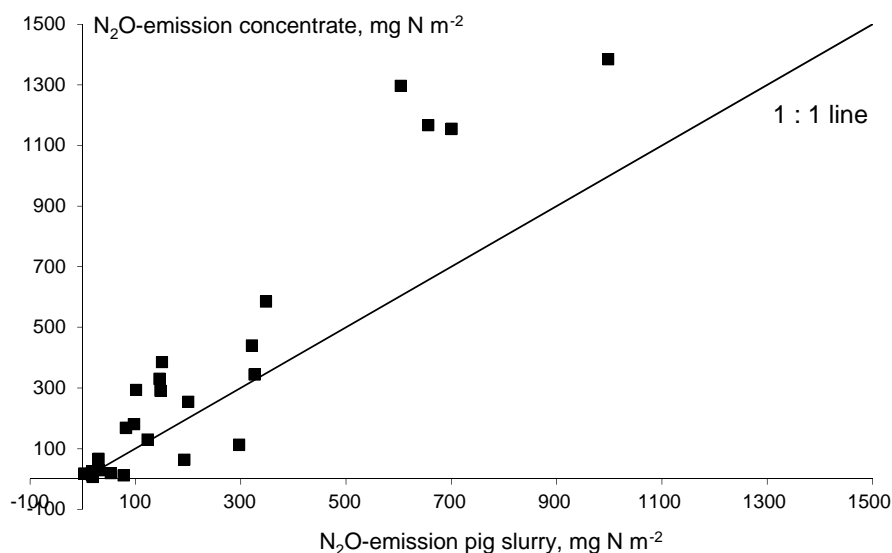

Figure 2. N_2O emission from pig slurry against N_2O emission from mineral concentrate. Results of all experiments.

4. Conclusion

A mineral concentrate from treated slurry is a fertilizer with a relatively high risk of NH_3 emissions. However, incorporation of mineral concentrates in the soil strongly decreases NH_3 emissions. The N_2O emissions from mineral concentrate applied to soil were higher than those from untreated pig slurry and calcium ammonium nitrate fertilizer.

References

- Oenema, O., Velthof, G.L., Yamulki, S. and Jarvis, S.C. 1997. Nitrous oxide emissions from grazed grassland. *Soil Use and Management* 13, 288-295.
- Paul, J.W. and Beauchamp, E.G. 1989. Effect of carbon constituents in manure on denitrification in soil. *Canadian Journal of Soil Science* 69, 49-61.
- Velthof, G.L. and Mosquera, J. 2011. The impact of manure application technique on nitrous oxide emission from agricultural soils. *Agriculture, Ecosystems and Environment* 140, 298-308.
- Velthof, G.L. 2011. Synthesis of the research within the frame-work of the Pilot Mineral Concentrates. Alterra, Wageningen, Alterra-report 2224 (<http://www.alterra.wur.nl/UK/>)

Estimating nitrate emissions to surface water: comparison of methods using detailed regional data and national data

Dupas, R.^a, Gascuel-Oudou, C.^a, Durand, P.^a, Parnaudeau, V.^a, Delmas, M.^b, Deronzier, G.^c, Domange, N.^c

^aINRA-AgroCampus Ouest UMR Sol Agro et hydrosystème Spatialisation, Rennes, France.

^bINRA Unité Infosol, Orléans

^cONEMA French National Agency for Water and Aquatic Environments, Paris, France

1. Background & Objectives

The European Union (EU) Water Framework Directive (WFD) requires River Basin District managers to carry out an analysis of nutrient pressures and impacts, in order to evaluate the risk of water bodies failing to reach “good ecological status” and to identify those catchments where prioritized nonpoint-source control measures should be implemented. A methodology is developed to estimate nitrate nonpoint-source emissions to surface water, using readily available data at national scale. In addition to this application at national scale, the model was tested in the Brittany region (western France), where detailed regional databases are available. Brittany is a case worthy of study, as it allows comparing prediction of the models taking into account the national-wide databases and more detailed regional data.

2. Materials & Methods

The model is inspired from US model SPARROW (Smith al., 1997) and European model GREEN (Grizzetti et al., 2008), i.e. a statistical approach consisting of linking nitrogen sources and catchment land and river characteristics. The nitrate load (L) at the outlet of each river basin is expressed as:

$$L = R * (B * DS + PS) \quad [1]$$

where DS is diffuse sources (i.e. N surplus in $\text{kgN} \cdot \text{ha}^{-1} \cdot \text{yr}^{-1}$), PS is point sources from domestic and industrial origin ($\text{kgN} \cdot \text{ha}^{-1} \cdot \text{yr}^{-1}$), and R and B are the river system and basin reduction factors, respectively. Both factors were calibrated as:

$$B = \exp(\sum_i \alpha_i * X_i) \quad [2]$$

$$R = \exp(\alpha_j * X_j) \quad [3]$$

here X_i and X_j are independent variables for the basin and river reduction factors, respectively, α_i and α_j are parameters to be calibrated. The model was calibrated to fit mean annual nitrate load in 54 independent catchments ranging from 20km^2 to 2000km^2 in Brittany, for the 2004-2007 period. Variable selection was first performed on a simplified version of the model neglecting PS , in order to allow the linearization of equation [1]. Variables were selected according to Bayesian Information Criterion (BIC) in order to optimize the predictive performance of the model. Table 1 summarizes the variables which were tested and entered into the model, considering the national data and the detailed regional data. Note that variables which are expected to have a positive effect on transfer are entered in a reciprocal form. Hence, all α_i and α_j are expected to be negative and B and R should be lower than 1.

Table 1. Independent variables included in the model, considering both national data and regional data.

	<i>Variables</i>	<i>Regional Database</i>	<i>National Database</i>
Xi	1/Specific runoff ($\text{mm}^{-1} \cdot \text{yr}$)	Banque hydro (MEDDTL)	Effective rainfall (Météo France)
	Average distance to stream (m)	BD Carthage ® (IGN)	BD Carthage ® (IGN)
	% hydromorphic soil	Lemercier et al. (2011)	<i>Not entered into the model</i>
	1/Average slope (%)	50m DEM (IGN)	<i>Not entered into the model</i>
Xj	Average Hydraulic load ($\text{s.m}^{-1} \cdot \text{ha}^{-1}$)	Lamouroux et al. (2010)	Lamouroux et al. (2010)

Secondly, the non-linear least-squares estimates of the parameters in equation [1] were determined using a Gauss-Newton algorithm.

3. Results & Discussion

Figure 1 shows that better fitting is achieved when using the detailed regional data rather than the national data. Residual Standard Error was $6.87 \text{ kg N} \cdot \text{ha}^{-1} \cdot \text{yr}^{-1}$ in the first case and $9.55 \text{ kg N} \cdot \text{ha}^{-1} \cdot \text{yr}^{-1}$ in the second case.

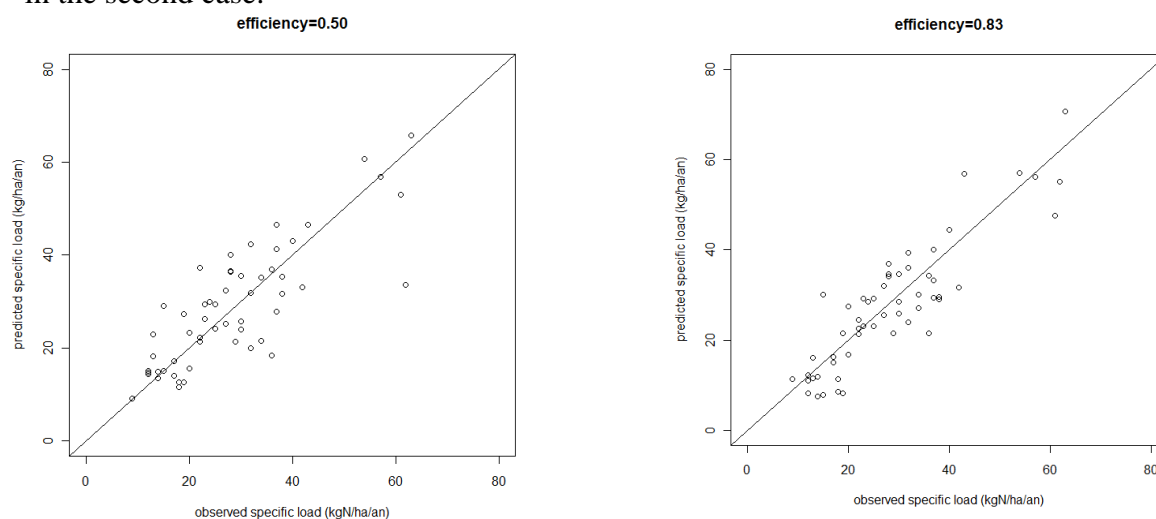

Figure 1. Predicted vs observed nitrate loads, considering the national database (left), and the regional database (right)

4. Conclusion

This study highlights that regional studies should be carried out in regions where detailed data is available, as a complement to the national scale evaluation.

References

- Grizzetti, B., Bouraoui, F. and De Marsily, G., 2008. Assessing nitrogen pressures on European surface water. *Global Biogeochemical Cycles* 22, X
- Lamouroux, N., Pella H., Vanderbecq A., Sauquet E. and Lejot J. 2010. Estimkart 2.0 : Une plate-forme de modèles écohydrologiques pour contribuer à la gestion des cours d'eau à l'échelle des bassins français. Version provisoire. Cemagref – Agence de l'Eau Rhône-Méditerranée-Corse – Onema
- Lemercier-Foucault, B., Lacoste, M., Loum, M. and Walter, C. 2011 (in press). Extrapolation at regional scale of local soil knowledge using boosted classification trees: A two-step approach. *Geoderma*
- Smith, R.A., Schwarz, G.E. and Alexander, R.B., 1997. Regional interpretation of water-quality monitoring data. *Water Resources Research* 33, 2781-2798.

Evaluation of a closed tunnel for field-scale measurements of N₂O fluxes at the soil-atmosphere interface

Schäfer, K.^a, Böttcher, J.^b, Weymann, D.^c, von der Heide, C.^b, Duijnisveld, W.H.M.^d

^aKarlsruhe Institute of Technology, Institute for Meteorology and Climate Research, Department Atmospheric Environmental Research (IMK-IFU), Garmisch-Partenkirchen, Germany

^bLeibniz University Hannover, Institute of Soil Science, Hannover, Germany,

^cForschungszentrum Jülich GmbH, Agrosphere Institute, Jülich, Germany,

^dFederal Institute for Geosciences and Natural Resources, Hannover, Germany

1. Background & Objectives

Emissions of the powerful greenhouse gas nitrous oxide (N₂O) from soils are commonly characterized by huge spatial variability. An upscaling of classical small-scale chamber measurements is thus questionable and may add uncertainty to emission inventories or emission factors. Therefore, field-scale approaches will become increasingly important. Since micrometeorological techniques are limited by stable atmospheric conditions (Pihlatie et al., 2005) and their low spatial resolution (Smith et al., 1994), we used a closed tunnel equipped with an open-path Fourier Transform Infrared (FTIR) spectrometer to (i) evaluate its feasibility for measuring field-scale N₂O fluxes from an unfertilized grassland soil and (ii) compare those results with small-scale fluxes obtained from closed chambers.

2. Materials & Methods

The measuring tunnel, consisting of a 99×5×0.6 m aluminium liner structure was closed with a commercial plastic cover prior to each measurement. The cover was sealed at the frame and the soil using sand-filled hoses. The FTIR technique enabled precise concentration measurements longitudinal through the whole tunnel atmosphere at five minute intervals. Based on those measurements, we used a non-steady-state approach to calculate the predeployment N₂O flux (q_0). This was achieved by taking into account diffusive gas transport between soil and tunnel atmosphere to simulate the N₂O concentration at the height of the FTIR measuring beam. We estimated q_0 inversely using measured concentration courses at the FTIR beam height, assuming that the boundary condition at the soil/tunnel interface can be described by:

$$q_1(z = 0, t) = \frac{q_0}{(t + 1)^\varepsilon} \quad [1]$$

with $q_1(z = 0, t)$: time course of N₂O flux at the soil/tunnel interface, ε : fit parameter ($0 \leq \varepsilon \leq 0.5$).

Predefined representative emission scenarios showed that this approach yields robust results within an uncertainty range of up to ± 30 % for the inversely estimated q_0 . Concurrent manual chamber measurements were performed in close vicinity to the tunnel, where each of four chambers covered an area of 0.045 m². N₂O fluxes were calculated using the non-steady-state diffusive flux estimator (NDFE) (Livingston et al., 2006).

3. Results & Discussion

During twenty-four measuring campaigns we found that the tunnel system is generally feasible for calm and dry weather conditions. Rain and high wind speeds were disadvantageous and add uncertainty to this otherwise precise method. Therefore, we restricted the measurements to the evening hours and to the first hour of tunnel closure. Field-scale N₂O fluxes determined by the

tunnel method were generally small and in a range between 0 and 28 $\mu\text{g N}_2\text{O-N m}^{-2} \text{h}^{-1}$ (Figure 1), which is typical for ‘background’ emissions from an unfertilized grassland site. In contrast, small-scale chamber based fluxes were spatially and temporarily variable (Figure 1). The mean daily N_2O fluxes for the chamber measurements ranged between -4 and 228 $\mu\text{g N}_2\text{O-N m}^{-2} \text{h}^{-1}$. The cumulative flux for the 11 comparable measuring dates was 513 $\mu\text{g N}_2\text{O-N m}^{-2} \text{h}^{-1}$ for the chamber method, but only 61 $\mu\text{g N}_2\text{O-N m}^{-2} \text{h}^{-1}$ for the tunnel approach. This difference was mainly caused by peak emissions occurring at three measuring dates which were only exhibited by the chambers.

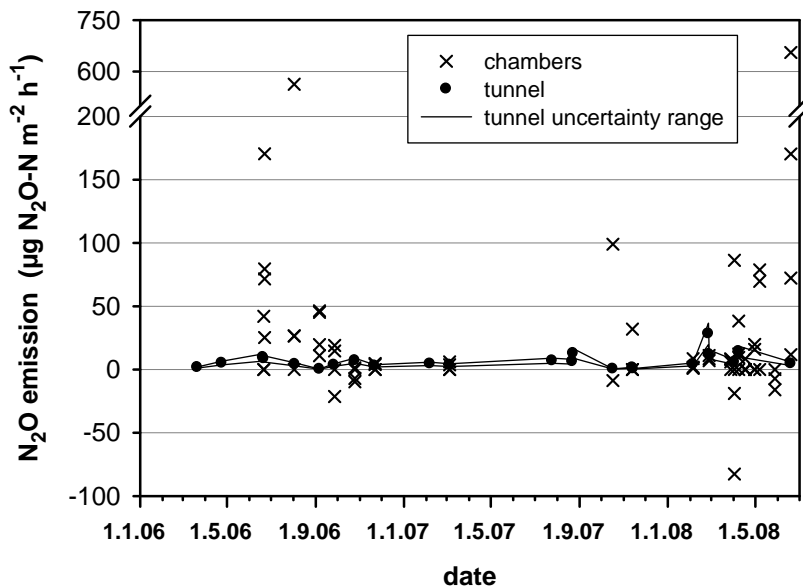

Figure 1. N_2O emissions (predeployment flux q_0) inversely estimated from tunnel measurements and concurrent chamber-based emissions (four replicates) calculated with NDFE during the whole measurement period.

Since chamber and tunnel measurements represent different scales it seems not appropriate to validate one method with the other one. However, we argue that the chambers were occasionally susceptible to detect hotspots and hot moments of N_2O emission, which results in an overestimation of the actual field-scale emission. This confirms the uncertainty associated with an up-scaling of N_2O fluxes obtained from the small-scale and underlines the need for field-scale measurements.

4. Conclusion

This study introduced a tunnel coupled to an open-path FTIR spectrometer which enables reliable measurements of N_2O fluxes particularly during stable atmospheric conditions. We conclude that this flexible field-scale approach has potential to fill an experimental gap between small-scale chamber and ecosystem-level micrometeorological methods.

References

- Livingston G.P., Hutchinson G.L. and Spartalian K. 2006. Trace gas emission in chambers: a non-steady-state diffusion model. *Soil Science Society of America Journal* 70, 1459-1469.
- Pihlatie M., Rinne J., Ambus P. et al. 2005. Nitrous oxide emissions from a beech forest floor measured by eddy covariance and soil enclosure techniques. *Biogeosciences* 2, 377-387.
- Smith K.A., Clayton H., Arah J.R.M., Christensen S., Ambus P., Fowler D., Hargreaves K.J., Skiba U. and Harris G.W. 1994. Micrometeorological and chamber methods for measurement of nitrous oxide fluxes between soils and the atmosphere: overview and conclusions. *Journal of Geophysical Research* 99, 16541-16548.

Evaluation of nitrogen fertilisation and irrigation strategies to optimize yield, quality and benefit in peach trees

Villar, J.M.^a, Pascual, M.^a, Fonseca, F.^b, Lordan, J.^{a,b}, Arbonés, A.^b, Rufat, J.^b

^a Universitat de Lleida (UdL), ETSEA, Av Rovira Roure 191, 25198 Lleida, Spain

^b Institut de Recerca i Tecnologia Agroalimentàries, IRTA, Av Rovira Roure 191, 25198 Lleida, Spain

1. Background & Objectives

Peach is an important irrigated fruit crop on the Ebro Valley, Spain. An adequate fertilisation is necessary to optimize production and quality in mature trees. Nitrogen management in peach production is also affected by irrigation management. Optimizing both the use of nitrogen and the environmental features is important to maintain productivity and fruit quality (Faust, 1989). The objective of this paper was to evaluate the effects of fertilisation on N uptake, yield and quality of peaches for the processing industry with different irrigation treatments on a shallow calcareous soil.

2. Materials & Methods

A five-year field experiment (2006–2010) on clingstone peach cv. Andross (GF305 rootstock) was conducted in a commercial orchard under mechanical harvesting for the processing industry (Rufat et al., 2011). A 3x3 factorial design with randomized complete blocks and four repetitions was established. Three nitrogen fertiliser treatments were 0, 60 and 120 kg N/ha, combined with three irrigation treatments: full irrigation throughout the growing season (FI); restricted irrigation during stage-II (70% restriction) (IR2) and restricted irrigation during stage-III (30% restriction) (IR3). The soil type was a shallow, well-drained, loam which had a petrocalcic horizon within 0.45 m of the soil surface (Petrocalcic Calcixerepts). The soil had a pH of 8.4, and 2.5-3% organic matter. Trees were fertigated (N32 solution) on a daily basis. The marginal product is the difference between fruit yield from treated plot and fruit yield from unfertilized plot. The marginal return is the product of marginal product and dry matter fruit price. Agronomic efficiency is the additional fruit yield per unit of added nutrient. Statistical analysis of data was carried out using the SAS-STAT package (SAS®, Version 9.2.).

3. Results & Discussion

Moderate N application (60 kg N ha⁻¹) produced, some seasons, the optimum yield and quality to meet industry requirements (preparing processed purées). However, it doesn't occur when all five years are analyzed together (Table 1). Nitrogen fertilisers supposed an increase of 7.9% fruit yield dry matter although no significant differences were found ($p=0.15$). There was a significant effect of N fertiliser rate on leaf N concentration (Table 2) but all treatments had concentrations above 2.6%, the minimum recommended for mid-shoot leaves (Johnson, 2008). Irrigation treatments significantly affected soluble solids concentration. Restricted irrigation during stage-II reduced the nitrogen use efficiency (Table 3). Soil organic matter mineralization, that was the only source of N in N0 treatments, can supply enough N to meet crop demand, even though an increasing tendency is observed with N applied (significant fresh fruit yield at $\alpha<0.10$).

4. Conclusions

From the results based on a five years study on irrigation and nitrogen interaction in a shallow soil, we conclude that to sustain peach fruit production, soil N mineralization was sufficient to meet crop demand over the five years period. Nevertheless, all N treatments exhibited higher N use efficiency than the economical threshold. The highest marginal benefit was for N60 treatment with full irrigation.

Table 1. Effect of N and irrigation treatments on total fresh and dry matter fruit yield, soluble solids concentration of the juice and average leaf N concentration during the 5-year period

Treatment	Cumulative N applied (kg N ha ⁻¹)	Total fresh fruit yield (t ha ⁻¹)	Total dry matter fruit yield (t ha ⁻¹)	Average soluble solids concentration of the juice (°Brix)	Average leaf N concentration (%)
N0 FI	0	202.6	26.7	10.92	2.90
N0 IR2	0	207.9	26.6	10.73	2.97
N0 IR3	0	198.6	26.8	11.21	2.96
N60 FI	300	240.9	30.1	10.18	3.26
N60 IR2	300	210.2	27.2	10.76	3.15
N60 IR3	300	212.2	29.2	11.51	3.13
N120 FI	600	225.2	29.0	10.53	3.36
N120 IR2	600	212.3	28.3	10.83	3.25
N120 IR3	600	206.0	28.6	11.53	3.35
Model		0.153	0.379	<0.0001	<0.0001
R ²		0.43	0.34	0.76	0.74
Block		0.324	0.138	0.0025	0.671
N treatment		0.087	0.150	0.487	<0.0001
Irrigation		0.095	0.559	<0.0001	0.596
Nitrogen*Irrigation		0.468	0.887	0.056	0.369

Table 2. Leaf N concentration and soluble solids for N and irrigation treatments respectively ($\alpha=0.05$)

Treatment	Average leaf N concentration (%)	Treatment	Average soluble solids concentration of the juice (°Brix)
N0	2.94 c	FI	10.5 b
N60	3.18 b	IR2	10.8 b
N120	3.32 a	IR3	11.4 a

Table 3. Profitability of different treatments

Treatment	Total dry matter fruit yield (kg ha ⁻¹)	Marginal product (kg ha ⁻¹)	Marginal return (€ha ⁻¹)	Marginal Benefit (€ha ⁻¹)	Nitrogen Use efficiency (kg kg ⁻¹)
N0 FI	26700				
N0 IR2	26600				
N0 IR3	26800				
N60 FI	30100	3400	3400	3040	11.3
N60 IR2	27200	600	600	240	2.0
N60 IR3	29200	2400	2400	2040	8.0
N120 FI	29000	2300	2300	1580	3.8
N120 IR2	28300	1700	1700	980	2.8
N120 IR3	28600	1800	1800	1080	3.0

The price of the dry matter peach and N being €kg⁻¹ (economic threshold)

References

- Faust, M. 1989. Physiology of temperate zone fruit trees. John Wiley, New York.
- Johnson, R.S. 2008. Nutrient and water requirements of peach trees, 303-331, In: The peach. Botany, production and uses. Layne D.R. and Bassi D. (eds.), CAB International.
- Rufat J., Domingo X., Arbonés A., Pascual M. and Villar JM. 2011. Interaction between water and nitrogen management in peaches for processing. Irrig. Sci. 29, 321-329.

Evidence of nitrate leaching hotspots over a vulnerable aquifer due to dry deposition of ammonia from poultry houses

Seeton, D.^a, Bittman, S.^a, Hunt, D.E.^a, Krzic, M.^b, Kowalenko, C.G.^a, Zebarth, B.J.^c

^aPacific Agri-food Research Centre, Agriculture and Agri-Food Canada, Agassiz BC Canada

^bFaculty of Land and Food Systems, U. of British Columbia, Vancouver, BC, Canada

^cPotato Research Centre, Agriculture and Agri-Food Canada, Fredericton, NB, Canada

1. Background & Objectives

Despite changes in farming practices there continues to be high levels of nitrate in the unconfined Abbotsford aquifer in southern British Columbia (BC) (Mitchell et al., 2003). Most of the aquifer sits under agricultural land dominated by production of raspberries and poultry. While the high nitrate level is often attributed to excessive fertilization of raspberry crops, the possible contribution of dry deposition of ammonia emitted from the many poultry houses has not been considered. Previous studies have reported high rates of dry deposition in close proximity to livestock houses (Fowler et al., 1998). This study evaluates dry deposition ammonia and potential leaching of nitrate and ammonium near broiler houses.

2. Materials & Methods

The study was conducted near Abbotsford, BC (coordinates 49.03, -122.52) with annual precipitation (mostly winter rain) of 1600mm. Emission and deposition measurements were made near a typical one-story broiler house; fans are fitted with hoods to direct exhaust air towards the ground to minimize dust dispersion. Ammonia concentration in exhausted air was measured during several bird production cycles (~37days) with phosphoric acid traps and ventilation rates with the FAN system (Gates et al. 2004). Dry deposition of ammonia was measured as sorption on dry soil samples over 24 hr periods (Hao et al., 2006). Nitrate leaching was monitored weekly, 28 Sept–27 Oct 2011, near another typical broiler barn using suction lysimeters installed in a grid pattern below root depth (45 cm); only an unreplicated series near a primary fan is reported here. Samples were taken just as rains were starting after ~8 weeks of dry weather; 171 mm rain fell during the measurement period. Soil samples were extracted with 2M KCl. Solutions from soil, lysimeter and acid trap samples were analyzed for ammonium (NH₄-N) and nitrate (NO₃-N) with a flow injection autoanalyzer.

3. Results & Discussion

Ammonia emission from the barn increased steeply over 37-day bird growth cycles, with some deviation due to weather and ventilation rates (not shown). Dry deposition of ammonia varied with emission rates and with distance from exhaust fans (not shown). Deposition rates often exceeded 50 kg NH₃-N ha⁻¹ day⁻¹ although these high rates occurred only within a few meters of active fans during the latter half of bird growth cycles. Initial estimates are that about 5-10% of the emitted ammonia is dry-deposited near the barn which is less than deposition downwind of beef feedlots in Alberta (Hao et al., 2006). Unlike open feedlots, poultry barns actively exhaust ammonia-laden air onto the ground surface potentially creating concentrated hotspots near the fans; such hotspots would vastly overload the capacity of the soil or grass crops to absorb deposited N, resulting in potential leaching. The lysimeter data collected in Sept-Oct 2011 supports this hypothesis as nitrate-N concentrations for that period exceeded 250 mg kg⁻¹ at 2.1 m

and 125 mg kg^{-1} at 3.6 m from fans (Figure 1). As with deposition, concentrations declined sharply with distance (Figure 2). There was evidence also of downward movement of ammonium probably due to the coarse texture of the soil and the large amount of deposition with insufficient time for nitrification (Figure 1).

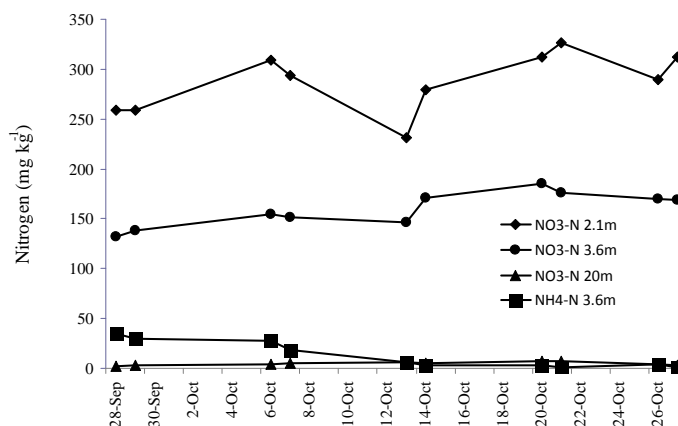

Figure 1. Concentrations of N as nitrate and ammonium in lysimeter samples collected Sept 28-Oct 27.

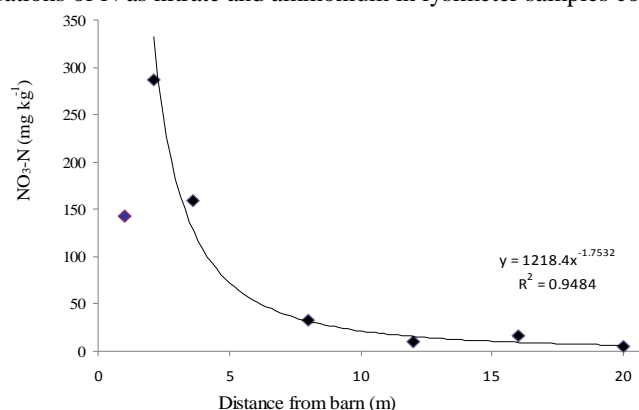

Figure 2. Concentrations of nitrate N (27 Sept- 28 Oct) in lysimeter samples at various distance from fans. Point nearest fans is not included in the regression.

4. Conclusion

This work provides direct evidence for hot spots of nitrate deposition and leaching near exhaust fans of poultry barns. The data needs to be up-scaled temporally and spatially to determine if this is an important source of nitrate in the Abbotsford aquifer

References

- Fowler D., Pitcairn C.E.R., Sutton M.A., Flechard C., Loubet B., Coyle M. and Munro R.C. 1998. The mass budget of atmospheric ammonia in woodland within 1 km of livestock buildings. *Env. Pollut.* 102, 343-348.
- Gates, R.S., Casey, K.D., Xin, H., Wheeler, E.F. and Simmons, J.D. 2004. Fan Assessment Numeration System (FANS) design and calibration specifications. *Trans. ASAE* 47, 1709-1715.
- Hao X., Chang C., Janzen H.H., Clayton G. and Hill B.R. 2006. Sorption of Atmospheric Ammonia by Soil and Perennial Grass Downwind From Two Large Cattle Feedlots. *J. Env.Qual.* 35, 1960-1965.
- Mitchell R.J., Babcock, R.S., Gelinas, S., Nanus, L. and Stasney D.E. 2003. Nitrate distributions and source identification in the Abbotsford-Sumas Aquifer, Northwestern WA State. *J. Env. Qual.* 32, 789-800.

Fertigation management of high density olive trees in calcareous soils

Rufat, J.^a, Villar, J.M.^b, Pascual, M.^b, Fonseca, F.^a, Calonge N.^b, Lordan, J.^{a,b}, Arbonés, A.^a

^a Institut de Recerca i Tecnologia Agroalimentàries, IRTA, Av Rovira Roure 191, 25198 Lleida, Spain

^b Universitat de Lleida (UdL), ETSEA, Av Rovira Roure 191, 25198 Lleida, Spain

1. Background & Objectives

The olive tree (*Olea europaea* L.) is a Mediterranean species adapted to water scarcity, low quality soils and low fertilizer requirements. However, recent trends to high and very high density orchards could lead to an increase on irrigation water and nutrient plant requirements. Nitrogen and potassium are the most important nutrients related to yield and mainly to oil quality. The objective of this paper is to evaluate the effects of N and K nutrition interaction on olive and oil yield and vegetative growth in high density olive orchards under different irrigation strategies in the Ebro Valley.

2. Materials & Methods

A three-year field experiment (2009–2011) on mature olive trees cv. Arbequina was conducted in a commercial orchard under mechanical harvesting for olive oil production. Two nitrogen doses (0 and 50 kg N ha⁻¹) and two potassium doses (0 and 100 kg K₂O ha⁻¹) were evaluated, combined with three drip irrigation treatments: surface full irrigation throughout the growing season (FI); surface restricted irrigation during pit-hardening (50% restriction) (RDC) and subsurface restricted irrigation (10% restriction throughout the growing season and an additional 50% restriction during pit-hardening) (SRDC). The soil was well-drained, moderately deep, and calcareous with silty-loam texture. The soil has a pH of 8.2 and 1% organic matter. Trees were fertigated with N32 and 0-0-15 solutions on a daily basis. Statistical analysis of data was carried out using the SAS-STAT package (SAS®, Version 9.2. SAS Institute Inc., Cary, NC, 1989-2009).

3. Results & Discussion

Irrigation water responses of yield (Table 1) and vegetative growth (Table 2) were greater where more water was supplied through irrigation with higher values for FI trees compared to SRDC ones. These differences may be related to inadequate ET_c and because water reserves were almost negligible (Ferrer et al., 2011). Therefore the RDC strategies in very high density orchards should be revised. After three years of experimentation, leaf N concentration (Table 1) was always above the deficiency threshold of 1.4% (Fernández-Escobar, 2009) and even above the reference value for excess N of 1.7% (Molina-Soria and Fernández-Escobar, 2010). Although a tendency for higher yield values was observed when N was applied, differences were only obtained for leaf N and soil N-NO₃⁻ concentration at harvest (Table 1). Soil K concentration was low (data not shown) but any difference was observed due to K application.

4. Conclusions

Behaviour of very high density olive orchards was quite different from low density ones. Both water management strategies and N-nutrient responses should be reconsidered because high yield increases (is this what is intended?) and higher tree growth were obtained when N was applied although leaf N concentrations for N-0 and N-50 treatments were above the excess threshold.

Table 1. Effect of irrigation, N and K treatments on total fruit and oil yield, leaf N concentration and final soil N-NO₃⁻ in 2011.

		Total fruit yield (kg tree ⁻¹)	Total oil yield (t ha ⁻¹)	Average leaf N concentration (%)	Average soil N-NO ₃ ⁻ concentration at harvest (ppm)
Model		0.01	0.03	0.01	0.03
Block		0.19	0.16	0.55	0.74
Irrigation treat		0.01	0.03	0.02	0.02
N treatment		0.12	0.50	0.01	0.01
K treatment		0.17	0.23	0.28	0.47
N*K		0.98	0.56	0.01	0.92
Irrigation*N*K		0.09	0.12	0.12	0.22
Treatment					
Irrigation	FI	11.6 a	2819 a	2.0 ab	9.2 ab
	RDC	10.4 ab	2640 ab	2.0 a	6.7 b
	SRDC	9.1 b	2351 b	1.9 b	22.5 a
N	0	10.0	2558	1.8 b	5.3 b
	50	10.8	2675	2.0 a	19.2 a
K	0	10.1	2541	1.9	13.8
	100	10.7	2686	2.0	11.1

Table 2. Effect of irrigation, N and K treatments on vegetative growth in 2011.

		Canopy volume in April (m ³ tree ⁻¹)	Canopy volume in December (m ³ tree ⁻¹)
Model		0.01	0.01
Block		0.26	0.05
Irrigation treat		0.01	0.01
N treatment		0.02	0.01
K treatment		0.82	0.56
N*K		0.61	0.15
Irrigation*N*K		0.79	0.43
Treatment			
Irrigation	FI	5.9 a	9.0 a
	RDC	5.2 b	7.1 b
	SRDC	5.0 b	6.3 c
N	0	5.2 b	7.1 b
	50	5.5 a	7.8 a
K	0	5.3	7.4
	100	5.4	7.6

References

- Fereres E., Villalobos F.J., Orgaz F. and Testi L. 2011. Water requirements and irrigation scheduling in olive. *Acta Hort.* 888, 31-39.
- Fernández-Escobar R., Parra M.A., Navarro C. and Arquero O. 2009. Foliar diagnosis as a guide to olive fertilization. *Spanish J. Agr. Res.* 7, 212-223.
- Molina-Soria C. and Fernández-Escobar R. 2010. The reliability of the established critical leaf nitrogen concentration in olive orchards. *Acta Horticulturae* 868, 209-212

First-year's and residual herbage N recovery from fresh and composted solid cattle manures

Shah, G.M.^a, Lantinga, E.A.^a

^aOrganic Farming Systems Group, Wageningen University, P.O. Box 563, 6700 AN, Wageningen, The Netherlands

1. Background & Objective

Only a fraction of the total nitrogen (N) from applied solid cattle manure (SCM) becomes plant available during the year of application, whereas its residual effects can last for many years (Schröder et al., 2007). Some farmers prefer to compost the SCM before application, but this may lead to tremendous N losses (Shah et al., 2010). Besides, only fragmentary information is available on the consequences of this pre-treatment for its N fertilizer value. Therefore, the aim of this study was to examine and compare first-year's and residual herbage N recovery after a single application of fresh and composted solid cattle manure to grassland at a range of input rates.

2. Materials & Methods

A three-year field experiment (2008-2010) was conducted in a perennial ryegrass (*Lolium perenne* L.) sward on a sandy soil (38 g kg⁻¹ organic matter, 1 g kg⁻¹ N_{total}, 0.3 mg kg⁻¹ N_{mineral}, carbon (C)/N ratio 22, and pH-KCl 5.3) just north of the city of Wageningen. Both fresh (FR) and composted (CO) SCM were surface-spread on grassland at once. This was done manually using pitchforks and three rates in the range from about 200 to 650 kg N ha⁻¹ were used. Each experimental unit measured 5 m by 3 m. All treatments, including a non-fertilized control, were arranged in a randomized complete block design with three replicates. FR manure was taken directly from a litter-barn, whereas CO manure was obtained after storing and extensively mixing FR manure during a period of 8 months as described by Shah et al. (2010). During each growing season, the herbage was harvested three times (second half of June, first week of September and the last week of October). The herbage was cut to a stubble height of 4 cm using a motor mower. Fresh herbage yield was measured in the field and representative samples were oven-dried at 70°C for 48 hours, ground to pass a 1 mm sieve and analysed for total N content. Subsequently, apparent N recovery (ANR) in each year was calculated by means of the N difference method.

3. Results & Discussion

The herbage N uptake in the non-fertilized control was on average 30 kg N ha⁻¹ year⁻¹. At the lowest N application rate, the herbage response in case of CO manure was not different ($P > 0.05$) from the control. In all probability, this was caused by immobilization of the applied and released mineral N since the soil C/N ratio of the used field was above 20 and thus relatively high. The initial mineral N content of the CO manure compared to the FR manure was almost three-times lower (7 vs. 20 g 100g⁻¹N_{total}) as a result of N losses during the composting process. Consequently, in the year of application herbage ANR was lower ($P < 0.01$) from the CO manure (Table 1; Figure 1). In the two succeeding years this pattern did not change and herbage ANR was almost zero in the last year for the CO manure (Table 1; Figure 1). This can be ascribed to the presence of more stable organic N compounds since most of the readily degradable organic N compounds are lost during composting (Kirchmann, 1985). This is another drawback of composting next to the high losses (up to 50%) of the initial total N content (Shah et al., 2010; Shah and Lantinga, 2012).

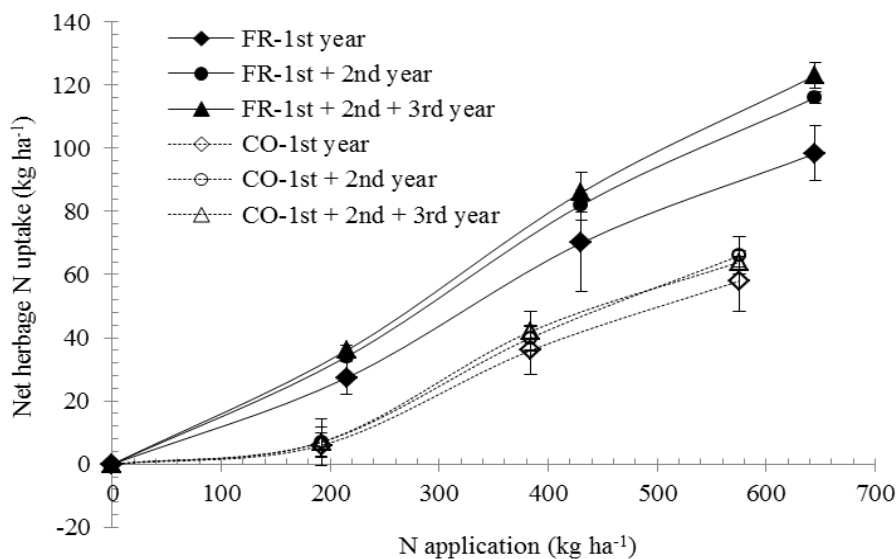

Figure 1. Net herbage N uptake from fresh (FR) and composted (CO) solid cattle manure. Error bars represent standard error (\pm) of the mean.

Table 1. Apparent herbage N recovery from the manures. Values in parentheses represent standard error of the mean.

Manure	N application (kg ha ⁻¹)	Apparent N recovery (% of total N applied)			
		Year 1	Year 2	Year 3	Total of 3 years
Fresh	215	12.2 (2.4)	3.1 (0.3)	1.6 (0.8)	16.9
	430	16.2 (3.6)	2.7 (1.1)	1.3 (1.4)	20.2
	645	15.1 (1.4)	2.8 (0.2)	1.2 (0.6)	19.1
	mean	14.5	2.8	1.3	18.7
Composted	192	3.1 (2.0)	0.3 (1.3)	0.7 (0.8)	4.1
	384	9.3 (1.9)	1.0 (0.9)	0.7 (0.6)	11.0
	575	10.1(1.7)	1.4 (1.0)	-0.1 (0.3)	11.4
	mean	7.5	0.9	0.4	8.8

4. Conclusions

During all three years, herbage N recovery from the fresh solid cattle manure was about twice as high compared to that from the composted treatment. The residual N fertilizing effect on this soil with a high C/N ratio was even almost zero in year 3 in the latter case. For use on grassland it is recommended not to compost solid cattle manure.

References

- Kirchmann, H. 1985. Losses, plant uptake and utilization of manure nitrogen during a production cycle. *Acta Agriculturae Scandinavica Supplementum* 24, pp. 77.
- Schröder, J.J., Uenk, D. and Hilhorst, G.J. 2007. Long-term nitrogen fertilizer replacement value of cattle manures applied to cut grassland. *Plant and Soil* 299, 83-99.
- Shah, G.M. and Lantinga, E.A. 2012. Effects of storage method on N disappearance and herbage N recovery from solid cattle manure. This workshop, pp. 2.
- Shah, G.M., Shah, G.A. and Lantinga, E.A. 2010. Management strategies to reduce nitrogen losses from solid cattle manure. In: Cordovil C., Ferreira L. (Eds.), *Proceedings of the 14th Ramiran International Conference*, 13-15 Sept. 2010, Lisboa, Portugal, pp. 204-207.

Forage yield and nitrogen utilization of forage maize hybrids in Organic Farming

Monteagudo, A.B.

Centro de Investigaciones Agrarias de Mabegondo (CIAM-INGACAL), A Coruña, Spain

1. Background & Objectives

Chemical nitrogen (N) fertilizers are the most widely used to increase the maize yield but their use is forbidden in Organic Farming (OF). Only a controlled amount of organic N fertilizer is allowed in OF and the availability of N for plant uptake is limited. Moreover, the lower N availability reduces the risk of N loss by leaching so N utilization efficiency (NUE) is interesting to consider for forage production at low N levels. In this context, the improvement of N uptake and utilization efficiency in forage production is required to prevent biomass yield reduction and nitrogen loss to the environment. The objective of this study was to evaluate forage maize yield and N utilization under OF conditions.

2. Materials & Methods

Thirteen maize hybrids obtained at CIAM-INGACAL and 3 commercial hybrids (C) were evaluated under OF conditions in two field trials in Lugo (NW Spain): 1. Xía, without organic fertilizer (0N); 2. Arroxo, where organic cattle manure was applied at a rate of 170 kg N ha⁻¹ (following the European Commission regulation No. 889/2008) in one application before planting (170N). Both soils came from a pasture rotation. Average rainfall and temperature during the growth cycle are presented in Figure 1. The experimental design was a randomized block with one plot of 8 m² per hybrid and three replications with 90.000 plant ha⁻¹ as the final plant density.

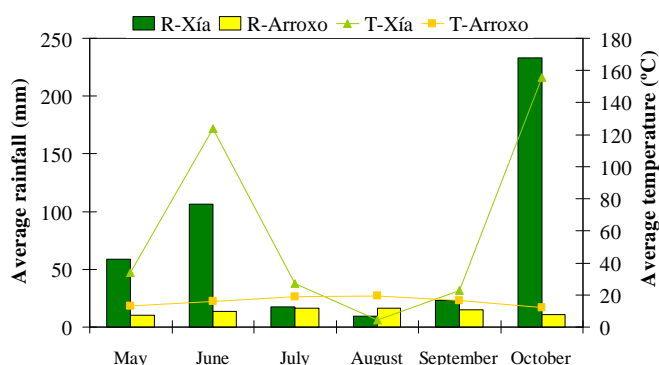

Figure 1. Mean rainfall and temperatures at field trials in 2009.

At the silage stage, samples of 300g of entire plant, stalk and ears per plot were grinded and dry weights were measured after drying them at 80°C for 16 hours. Forage yield was expressed as dry matter (DM) (Mg ha⁻¹) based on the number of plants at harvest. Dried samples were ground in a Christy Norris mill to pass a 1mm sieve. Near Infrared Reflectance Spectroscopy (NIRS) was used to estimate crude protein content (CP) according to Campo et al. (2010) equations. Nitrogen uptake was estimated from CP and DM yield in each sample (kg N ha⁻¹). NUE was calculated as the ratio of DM yield to whole plant N uptake (kg kg⁻¹) while the nitrogen harvest index was the ratio between ear N uptake and whole plant N uptake (kg kg⁻¹). Harvest index was calculated as the ratio of grain yield to biomass yield (Mg Mg⁻¹). The Duncan test to assess the differences between means and Pearson correlations between traits were calculated using the SAS statistical package v 9.2 (SAS Institute, 2008).

3. Results & Discussion

The strong relationship found between N stress and maize yield has been reported by different authors (Cox et al., 1993; Bertin and Gallais, 2000; Améndola et al., 2010). This association could be observed in our study as one of the factor on the reduction in forage yield of 17% for the C treatment under the same trial conditions (Table 1), but this reduction was less than that found by other authors in forage maize (Cox et al., 1993). Nitrogen uptake was lower at 0N than 170N trial due to a positive correlation existed between this trait and rate of N applied to soil ($r^2 > 0.7$, $P < 0.001$). This result is in disagreement with other studies (Dobermann, 2005).

Table 1. Forage yield, total nitrogen uptake (N_t), nitrogen uptake in stover (N_{stover}), nitrogen uptake in ear (N_{ear}), harvest index (HI), nitrogen utilization efficiency ($NUtE$) and nitrogen harvest index (NHI) of forage maize hybrids.

Trial	Forage yield	N_t	N_{stover}	N_{ear}	HI	$NUtE$	NHI
	$Mg\ ha^{-1}$						
0 N	15.48b	121b	50b	70b	0.68b	128.89a	0.59a
170 N	18.69a	195a	104a	90a	0.79a	96.09b	0.47b
Hybrids							
CIAM	17.33a	160a	80a	81a	0.72b	112.25a	0.53a
C	16.01b	140b	70a	79a	0.79a	113.52a	0.54a

Means in a column with different letter are statistically different ($P < 0.05$) within trial and hybrid.

In agreement with other studies negative correlations were found between N_t , N_{stover} and $NUtE$ ($r^2 > -0.88$) and HI and NHI were positively correlated ($r^2 = 0.85$). $NUtE$ could have been affected by rainfall being low in August and high in October in the 0N trial. Its value was higher at low N supply so utilization efficiency was better at these trial conditions. Hybrids showed genetic variability with means statistically different for all traits studied within the CIAM group which had better performance than the commercial ones.

4. Conclusion

Nitrogen uptake and utilization were variable amongst hybrids and so an improvement of N use efficiency could be possible by plant breeding programs. Evaluated hybrids were able to adapt to low N input with little reduction in forage yield and an increase in the nitrogen utilization efficiency.

References

- Améndola R., Cach I, Álvarez E., López I, Burgueño J., Martínez P. and Cristóbal D. 2011. Nitrogen balance in forage maize with different fertilization and phase of crop rotation with pastures. *Agrociencia* 45, 177-193.
- Bertin P. and Gallais A. 2000. Genetic variation for nitrogen use efficiency in a set of recombinant maize inbred lines I. Agrophysiological results. *Maydica* 45, 53-66.
- Dobermann A. 2005. Nitrogen use efficiency - state of the art. IFA International Workshop on enhanced-efficiency Fertilizer. Germany, pp. 1-16.
- Campo L., Castro P. and Moreno-González J. 2010. Ecuaciones de calibración preliminares para la evaluación de la calidad de la biomasa en plantas de maíz por NIRS. In: Calleja A., García R., Ruiz A. and Peláez R. (eds.), *Pastos: Fuente natural de energía*. Zamora, Spain, pp. 135-139.
- Cox W.J., Kalonge S., Cherney D.J. and Reid W.S. 1993. Growth, yield and quality forage under maize different nitrogen management practices. *Agronomy Journal* 85, 341-347.
- European Commission regulation N° 889/2008. Implementation of Council Regulation (EC) No 834/2007 on organic production and labelling of organic products with regard to organic production, labelling and control.
- SAS Institute. 2008. SAS version 9.2. SAS Institute Inc., Cary, NC.

Gap filling of missing data for calculating the cumulated ammonia emission in a fertilized bare soil: a case study in Lombardia region (Italy)

R.M. Ferrara^{a,c}, M. Carozzi^b, M. Acutis^b, N. Martinelli^a, G. Rana^a

^aCRA - Research Unit for Agriculture in Dry Environments, Bari, Italy

^bUniversity of Milan, Di.Pro.Ve, Milan, Italy

^cCRA - Research Centre for Agrobiological and Pedology, Florence, Italy

1. Background & Objectives

The ammonia (NH₃) concentration data necessary for estimating NH₃ fluxes are often unavailable. Reasons for this can be: (i) the detection range of detectors is outside the actual concentration values; (ii) the measuring equipment are upwind with respect to the fertilization spreading point; and (iii) occasional gaps occur owing to instrumental failure. In such situations, to obtain a complete time series from which to calculate cumulative NH₃ emissions, empirical estimates of missing fluxes are needed. The objective of the present study was to assess the reliability of the method developed by Spirig et al. (2010) for determining missing NH₃ flux values using data from slurry application experiments in the Lombardia region of northern Italy.

2. Materials & Methods

Applying the single layer model developed by Sutton et al. (1998), applied to bare soil, the NH₃ flux is calculated as

$$F_{\chi} = \frac{\chi(z_0') - \chi(z)}{R_a(z) + R_b} \quad [1]$$

where $\chi(z_0')$ is the NH₃ concentration estimated at the surface, $\chi(z)$ is the concentration measured at height z , and R_a and R_b are the aerodynamic and the boundary layer resistances, respectively, calculated according to Flechard et al. (2010).

Firstly, for the NH₃ fluxes measured in non problematic phases, values for $\chi(z_0')$ were derived using Equation 1. Secondly, an operational relationship was found between $\ln(\Gamma_s)$ and the time after slurry application (in hours), where Γ_s is the [NH₄⁺] to [H⁺] ratio (Dasgupta and Dong, 1986):

$$\Gamma_s = \frac{\chi(z_0') \times 10^{-9}}{10^{4.1218 - 4507/T}} \quad [2]$$

where T is air temperature in K, and χ is given in ppb. This operational relationship was found to be linear and was used to derive $\chi(z_0')$ as a function of time after slurry spreading when the values of NH₃ fluxes were not available. The value of $\chi(z)$ should always be available. The estimation of missing NH₃ fluxes after slurry application is determined in a range, between a minimum and a maximum. The lower limit is obtained by log-linearly interpolation of Γ_s , while the upper limit is obtained using the initial surface concentrations calculated by repeating the Γ_s of slurry until the first experimental surface concentration was available.

The method described above was applied in an experimental trial in Landriano (Lombardia, Italy), where slurry was applied to bare soil (87 m³ ha⁻¹ with 188 kg N ha⁻¹, 95 kg N-NH₄⁺ ha⁻¹, 4.4% of dry matter and pH 8) on 27 March 2009, starting at 9:00 a.m. The NH₃ fluxes were measured by the eddy covariance technique (Kaimal and Finnigan, 1994), using a Gill R2 (Gill Instruments Ltd, UK) sonic anemometer together with the QC-TILDAS developed by Aerodyne (USA) (Zahniser et al., 2005). The fluxes in the first 4 hours were not measured because the equipment was upwind with respect to the direction of the slurry spreading. NH₃ concentrations in air were also measured by passive diffusion samplers (ALPHA samplers; Sutton et al., 2001) both upwind and downwind.

In order to evaluate the performances of the model, it was tested in another experimental campaign (Cornaredo, Lombardia region, Italy) where slurry was applied on 17 March 2010 starting at 9:00 a.m. and where all the values of NH₃ fluxes were available. In this case, the fluxes were determined using the inverse dispersion model WindTrax (Flesch et al., 1995) with the NH₃ concentrations measured by ALPHA samplers (every 2 hours during the spreading day) and the model input variables measured using a sonic anemometer.

3. Results & Discussion

Figure 1 shows the good agreement obtained between estimated and measured NH_3 fluxes in the first day of the trial in Cornaredo (MAE=2.63; RRMSE=37.22; EF=0.86; slope=0.99; $r^2=0.9$): in this case only the lower limit was used (Eq. 1 & 2) because the slurry was homogeneously applied and we suppose that the emission started uniformly at $t=0$.

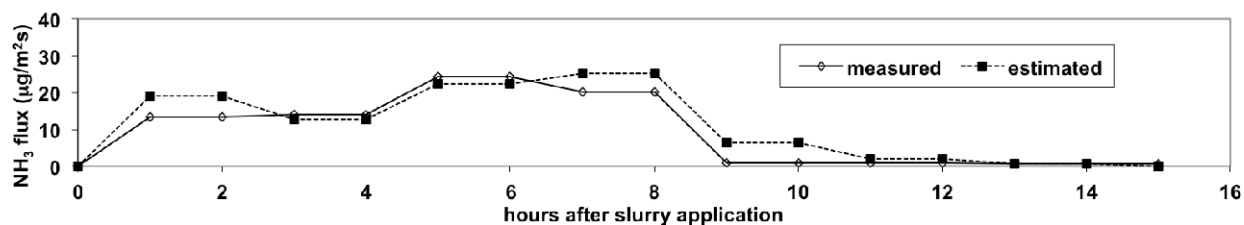

Figure 1. Comparison between estimated and measured NH_3 fluxes in Cornaredo during and after slurry spreading.

The model was then applied to the Landriano trial (Figure 2), where the measurements of NH_3 concentration were missed for the first 6 hours. In this case upper and lower limits of the estimated fluxes are shown with the measured fluxes in the last part of the period. Moreover, the relationship between $\ln(\Gamma_s)$ and the hours after slurry application is plotted, together with the linear relationship used to determine the estimated values of $\chi(z_0')$.

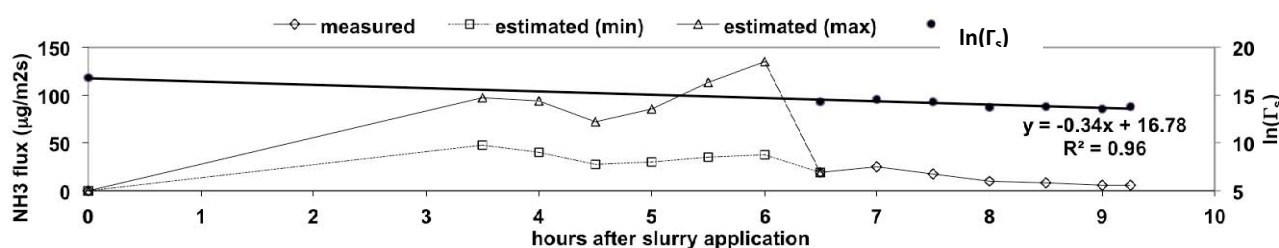

Figure 2. Values of NH_3 fluxes estimated and measured in Landriano during and after slurry spreading; the values in the first 6 and half hours are estimated by the presented model as lower and upper limits. Moreover, the operational relationship between $\ln(\Gamma_s)$ and hours after slurry application is shown.

4. Conclusion

Considering that the model worked well in one site (Cornaredo), we applied it in another site (Landriano) where the first flux data were not available, showing that it is an useful tool for estimating the missing NH_3 fluxes during the first hours after slurry spreading, which is the dominant period for NH_3 volatilization.

References

- Dasgupta P.K. and Dong S. 1986. Solubility of ammonia in liquid water and generation of trace levels of standard gaseous ammonia. *Atmos. Environ.* 20, 565-570.
- Flechar C.R., Spirig C., Neftel A. and Ammann C. 2010. The annual ammonia budget of fertilised cut grassland – Part 2: seasonal variation and compensation point modeling. *Biosciences* 7, 537-556.
- Flesch, T., Wilson, J.D. and Yee, E., 1995. Backward-time Lagrangian stochastic dispersion models, and their application to estimate gaseous emissions. *J. Appl. Meteor.* 34, 1320-1332.
- Kaimal J.C. and Finnigan J.J. 1994. *Atmospheric Boundary Layer Flows: Their Structure and Measurement*. Oxford University Press, 289 pp.
- Spirig C., Flechar C.R., Ammann C. and Neftel A. 2010. The annual ammonia budget of fertilised cut grassland – Part 1: micrometeorological flux measurements and emissions after slurry application. *Biogeosciences* 7, 521-536.
- Sutton M.A., Miners B., Tang Y.S., Milford C., Wyers G.P., Duyzer J.H. and Fowler D. 2001. Comparison of low-cost measurement techniques for long-term monitoring of atmospheric ammonia. *J. Env. Monit.* 3, 446-453.
- Sutton, M.A., Burkhardt J., Guerin D., Nemitz E. and Fowler D. 1998. Development of resistance models to describe measurements of bi-directional ammonia surface atmosphere exchange. *Atmos. Environ.* 32(3), 473-480.
- Zahniser M.S., Nelson D.D., McManus J.B., Shorter J.H., Herndon S. and Jimenez R. 2005. Development of a Quantum Cascade Laser-Based Detector for Ammonia and Nitric Acid. Final Report, U.S. Department of Energy, SBIR Phase II, Grant No. DE-FG02-01ER83139.

Generation of N-balances to describe N-flows and N-transformations -The example of composting

Körner, I.

Hamburg University of Technology, Institute of Waste Water Management and Water Protection, Bioconversion and Emission Control Group, Hamburg, Germany

1. Background & Objectives

The global N-household involves of a multitude of reactions and N containing compounds transform permanently from one form into another. In composting many of the globally important reactions are taking place as well – ammonification, nitrification, denitrification and N-immobilisation – and connections to other spheres exist via N-releases by leaching and off-gas evolution (Körner, 2008). In the literature few articles present N-balances and those that do mostly only consider in- and output and without a time dependent series. The objective of this paper is to show, that it is possible to generate N-balance-series accurate enough to describe processes of N-dynamics. Guidelines to generate such balances shall be given and the limitations shown.

2. Materials & Methods

53 composting experiments were carried out using 100 litres reactors and a broad range of substrates as well as process control variants. N-compounds were determined at different phases of composting – organic N, NH_4^+ / NH_3 , NO_3^- , NO_2^- in the substrate and in the leachate as well as N_2 , NH_3 , N_2O and partly NO in the off-gas. The milieu and process conditions (temperature, pH, water content, aeration rate, turning rhythm) were registered as well. In total 708 N-balances were calculated using the various N-concentrations and the respective masses of substrates, leachates and off-gases. Additionally, the N-losses due to sampling were considered (Figure 1). A statistical evaluation of all N-balances was carried out to conclude about the N-flows and N-transformations. To judge accuracy of the balances, all measurements were quantitatively evaluated regarding systemic uncertainties and mathematically summarized to an overall uncertainty. An extended uncertainty analyses was carried out to judge different substrates. All methods are documented in Körner (2008).

3. Results & Discussion

Figure 1 shows, that sampling losses are not negligible and that comparing in- and output balances

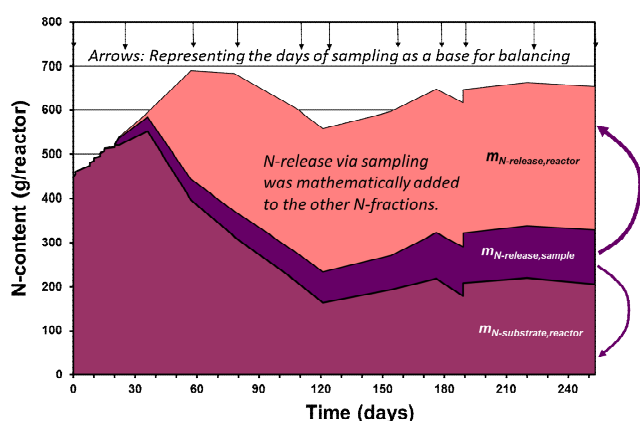

Figure 1 N-balance-series with portions in the reactor, released via sampling and via leachate and off-gas

only easily could mislead regarding conclusions. Figure 2 shows two N-balance-series corrected regarding the sampling error. The balances contain all N-compounds from quantitative significance. N_2 was measured, but values were not useable for balancing. The surplus of N_2 in the air used for aeration caused a too high dilution. But theoretical calculations showed that N_2 -generation could be significant. The generated amounts were indirectly evaluated using the lack in the balances (Figure 2, right). Amounts of other N-compounds showed insignificant (N_2O , NO , NO_2^-).

Knowing the accuracy of the balances is essential for correct conclusions. Systemic uncertainties were determined with $\pm 10\%$. Additionally the sample had an impact. In early phases of composting the total uncertainties summarized to $\pm 15\text{-}25\%$, for very inhomogeneous substrates even up to $\pm 85\%$. In later phases the homogeneity increased and uncertainty was between $\pm 15\text{-}25\%$ (Figure 2).

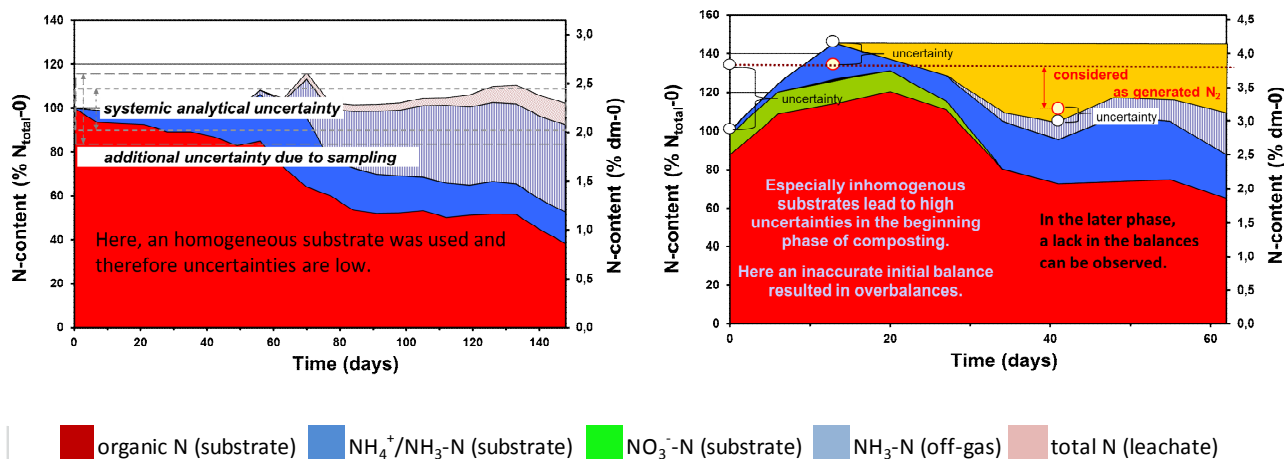

Figure 2. N-balance-series of composting processes: Left) Balance with high accuracy; Right) Balance with lower accuracy and a lack due to compounds not measured quantitatively (dm -0: initial dry-matter content)

By the balances, the various processes of N-dynamics could be judged (Table 1). The results reflect composting in general, since a large spectrum of substrates and milieu conditions was considered. Nitrification and denitrification were quantifiable, for ammonification a range and for immobilisation a maximum could be given.

Table 1. N-turnover processes during 53 composting experiments (min – minimum turnover; max – maximum possible turnover; direct – determined via metabolism products; indirect - via calculations using the balances).

Process	Method	Transformation in % of initial N		
		25%-Quantile	Median	75%-Quantile
Ammonification	min, direct	12	42	58
	min, indirect	19	35	48
	max, indirect	91	95	99
Nitrification	direct	0	3	12
	indirect	0	2	19
Denitrification	indirect	0	2	10
Immobilisation	Max, indirect	41	62	75

4. Conclusion

For balancing, organic N, $\text{NH}_4^+/\text{NH}_3$, NO_3^- (substrate), NH_3 (off-gas), total N (leachate) have to be measured. To evaluate N-flows and -transformations a series of at least 5 N-balances is necessary. Especially the initial N-balance has to be prepared with measurements based at least on 5 samples for inhomogeneous substrates. N-balance lacks or overbalances due to uncertainties are not avoidable, but can be quantitatively described. In follow up experiments, quantification of N_2 generation, ammonification and immobilisation could be eventually possible using ^{15}N -tracers.

References

Körner, I. 2008. Stickstoffhaushalt bei der Kompostierung: Bilanzen, Gehalte, Umsetzungs- und Austragsprozesse. Habilitation, Hamburg University of Technology; Verlag Abfall aktuell, ISBN 978-3-9812867-0-0

Impact of point injection of ammonium fertilizer on nitrous oxide fluxes and nitrogen dynamics in soil

Deppe, M.^a, Well, R.^a, Kücke, M.^b, Flessa, H.^a

^aInstitute of Agricultural Climate Research, Johann Heinrich von Thünen-Institut, Federal Research Institute for Rural Areas, Forestry and Fisheries, Braunschweig, Germany

^bInstitute of Crop and Soil Science, Julius Kühn-Institut, Federal Research Centre for Cultivated Plants, Braunschweig, Germany

1. Background & Objectives

Nitrogen fertilization can have an important impact on the amount of N₂O produced and emitted. Injection of nitrogen fertilizer has been widely used, but measured effects on N₂O emission are contradictory (Millar et al., 2010). High concentrations of ammonium are known to inhibit nitrification (Wetselaar et al., 1972); however, it has not yet been clarified how N₂O production is affected. Injection of nitrate-free ammonium-N fertilizer, in Germany also known as CULTAN (controlled uptake long-term ammonia nutrition), is supposed to inhibit nitrification of NH₄-fertilizer, leading to lower rates of nitrate leaching and lower rates of N₂O emission. To test this assumption, emission rates of N₂O are measured in two arable soils in Northern Germany with different textures (loamy sand and clay loam) cropped with winter wheat to compare two application methods (point injection and surface application) of nitrogen fertilizer.

2. Materials & Methods

Ammonium sulphate (130 kg N ha⁻¹) was applied either by point injection (24 x 17 cm grid) or by broadcast/surface application. Unfertilized plots serve as control. N₂O emissions are measured weekly using static chambers (closure time was approx. 1h). Nitrate and ammonium concentrations at injection spots and in bulk soil are measured at least biweekly in soil extracts (1M KCl, segmented flow analyser) to monitor nitrogen dynamics. Measurements started in February 2011 and will end in winter 2012/2013. At the loamy sand site, 5% ¹⁵N-ammonium sulphate is used as a tracer to distinguish between fertilizer-N and soil-N derived N₂O.

3. Results & Discussion

NH₄⁺-N from point injection was largely depleted within 6 (loamy sand) and 10 (clay loam) weeks after fertilization in 2011. Surface application led to longer periods with high ammonium content in soil, and nitrate concentrations at both sites were always higher compared to plots with point injection. Emission rates of N₂O were low at both sites in 2011. During spring, when the soil was relatively dry, N₂O emissions only occurred at single times, leading to high standard deviations of calculated fluxes. These emission events mostly occurred after fertilization, precipitation and/or tillage (Figure 1) and accounted for most of the total N₂O lost. Apart from these single events, flux measurements were generally near the limits of detection during the measuring period. There was no significant effect of point injection on total N₂O emissions. Higher emissions from the clay loam site were the result of one plot (n=3) with extremely high rates at single dates; at the sandy loam site, emissions from injection plots were slightly lower than from plots with surface application (Figure 2). Fertilizer derived N₂O fluxes were calculated from δ¹⁵N in gas samples taken between fertilization and harvest in 2011. Integrated over this period, fertilizer derived N₂O contributed about one third to total N₂O emissions. However, whereas N₂O fluxes derived from chamber concentrations were often close to the detection limit, fluxes estimated from δ¹⁵N of N₂O from the tracer experiment could always be calculated and therefore provided improved precision at low emission rates.

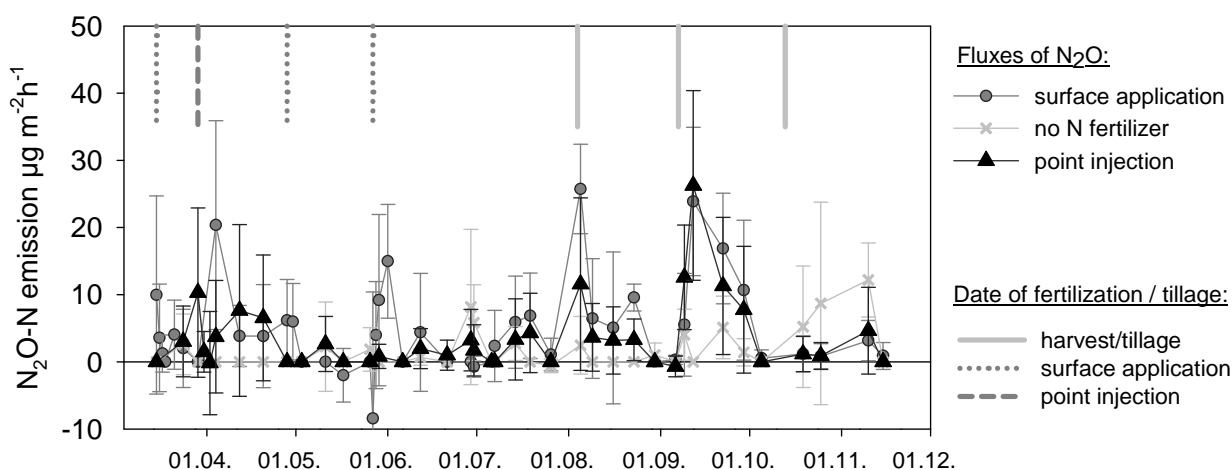

Figure 1. Emission rates of nitrous oxide from the loamy sand site in 2011. Vertical bars indicate dates of fertilization (dotted = broadcast surface application, dashed = point injection) or harvest/tillage (solid gray).

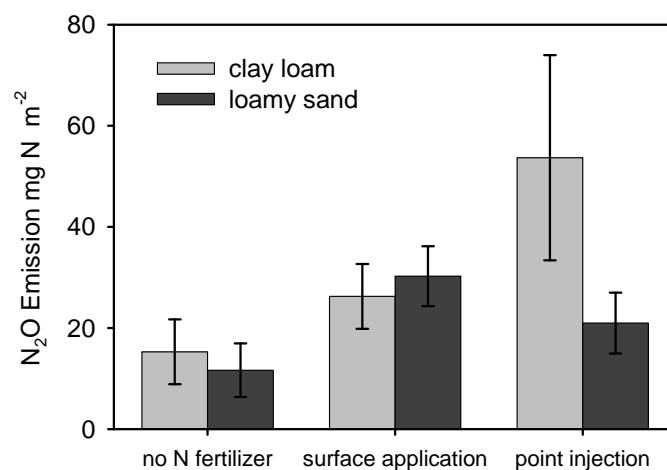

Figure 2. Total emission of nitrous oxide from both sites between 15/03/04 and 18/11/2011

4. Conclusion

Point injection of ammonium sulphate led to lower nitrate content in soils compared to surface application. Due to the low N_2O fluxes of all treatments, no significant impact of the fertilizer application technique on total N_2O emission could be detected.

References

- Wetselaar, R., Singh, B. R. and Passioura, J. B. 1972. Consequences of Banding Nitrogen Fertilizer in Soil. 1. Effects on Nitrification. *Plant and Soil* 36(1), 159-175.
- Millar, N., Robertson, G. P., Grace, P. R., Gehl, R. J. and Hoben, J. P. 2010. Nitrogen fertilizer management for nitrous oxide N_2O mitigation in intensive corn (Maize) production: an emissions reduction protocol for US Midwest agriculture. *Mitigation and Adaptation Strategies for Global Change* 15(4), 411-411

Impact of quality of residue mulches and their decomposition on N dynamics in soil in conservation agriculture

Iqbal, A.^a, Recous, S.^a, Aslam, S.^b, Alavoine, G.^a, Benoit, P.^b, Garnier, P.^b

^aINRA, UMR Fractionnement des AgroRessources et Environnement, F-51000 Reims, France

^bINRA, UMR Environnement et Grandes Cultures, F-78500 Thiverval-Grignon, France

1. Background & Objectives

Improving crop rotations, reducing or suppressing soil tillage, and maintaining a mulch of crop residues at the soil surface are gaining popularity throughout the world. But the impacts of these practices and of their combination on soil processes are not well understood. The general objective of the work was to study, for different crop associations and pedo-climatic conditions in temperate (France) and tropical (Madagascar and Brazil) agrosystems under conservation agriculture, the effects of residue mulch characteristics on their decomposition, N mineralization-immobilization, N transport in soil and N₂O emissions. And to assess, by modeling, how these factors affect agroecosystem services in a range of agricultural conditions met in conservation agriculture of France, Brazil and Madagascar. The hypotheses were that the chemical quality of mulches at the soil surface significantly affects the water exchange between soil, mulch and the atmosphere, the dynamics of mulch decomposition and the N fluxes in soil and to the atmosphere (Figure 1).

This work is part of a larger project on conservation agriculture (PEPITES, ANR SYSTERRA) which brings together researchers and stakeholders, working on social processes, technical innovation and ecological processes, particularly those linking organic matter and soil biological functioning.

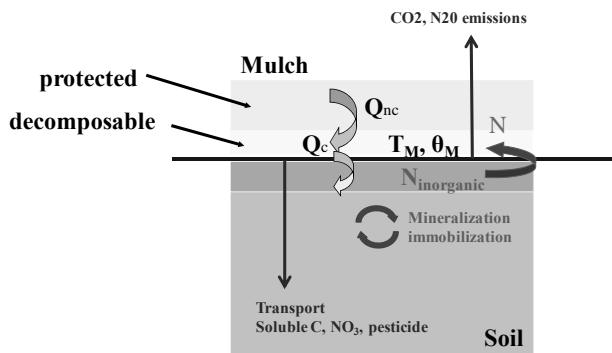
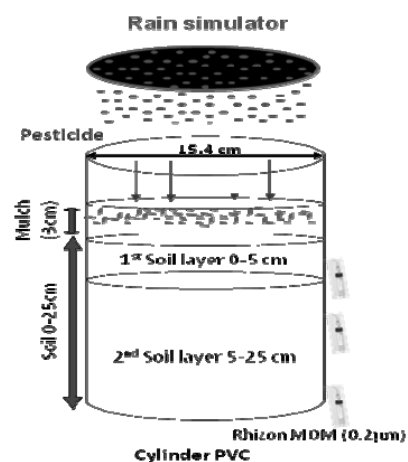

Figure 1. Representation of soil processes directly influenced by the presence of residue mulch at the soil surface (adapted from Findeling et al., 2007)

Figure 2. Experimental design for the soil columns



2. Materials & Methods

A series of experiments were performed under controlled conditions with repacked soil columns, 15.4 cm wide x 30 cm deep (Figure 2). The treatments were two mulch types, a mixture of *Zea mais* & *Doliquos lablab* and *Triticum aestivum* & *Medicago sativa*, two soil types (sandy or loamy soils) and two water regimes (manipulated through the intensity and frequency of rain applied with a rain simulator to the columns). Amended columns were incubated for 84 days at 20°C. CO₂ and N₂O were continuously measured by infrared photoacoustic spectroscopy. Mulch C and N (by total combustion), Soil microbial biomass C (fumigation-extraction) and mineral N (KCL extraction)

were measured through destructive sampling at 0, 14, 41 and 84 days. The *Pastis_Mulch* model (Findeling et al., 2007) was tested and used to calculate fluxes that are not measurable (gross mineralization and immobilization, nitrate and soluble C leaching) and to extrapolate the longer term fate of C and N.

3. Results & Discussion

The results show significant differences between the two mulches in term of C mineralization (Figure 3a), net N mineralization (data not shown) and N₂O emissions, due to the difference in the chemical composition of the plant residues (data not shown). The CO₂ evolved with M+D mulch was much higher for the loamy soil compared to the sandy soil (Figure 3b), due to the difference in C mineralization of the two soils. Conversely, the decomposition of the mulch was not influenced by the type of soil, under the controlled conditions of the experiment (data not shown). The emission of N₂O was nil during the decomposition of the M+D mulch on the sandy soil, while N₂O emission was observed during the first two days of mulch incubation with the loamy soil. The maximal rate was 110 mg N₂O m⁻² day⁻¹ at 20°C. The simulation with *Pastis* model confirmed the importance of water dynamics in controlling the decomposition rates and the fate of C into the soils, while the chemical quality of mulches is less crucial when the system is controlled by moisture.

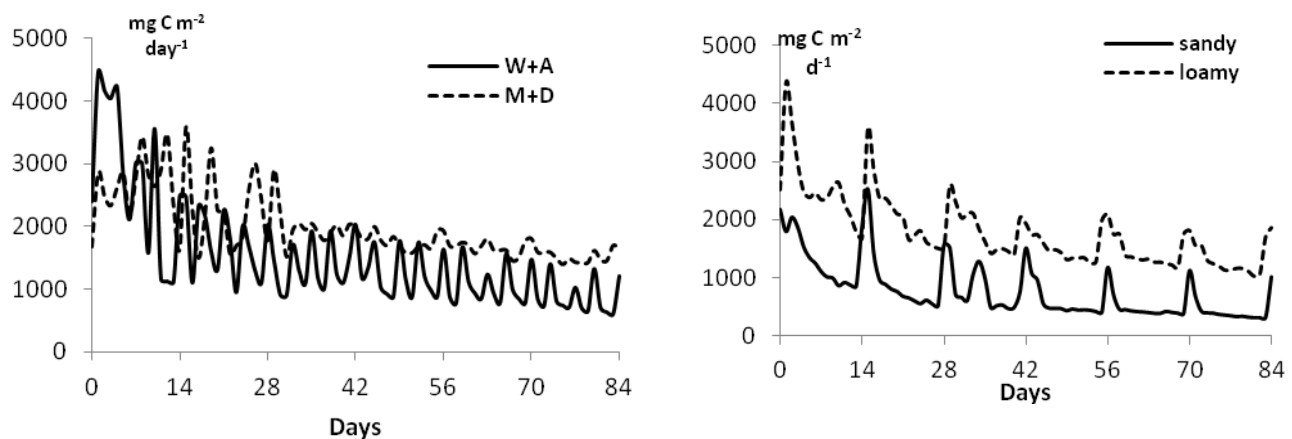

Figure 3a,b: C-CO₂ emission during decomposition of wheat+alfalfa mulch (W+A) and maize+dolichos mulch (M+D) on loamy soil (left) and comparison of sandy and loamy soil with decomposing M+D mulch (right). Peaks correspond to application of rain on columns.

Acknowledgements

This work is supported by the French ANR Systerra program (2009-2012) de Tourdonnet S., Triomphe B., Scopel E. et al. Processus Ecologiques et Processus d'Innovation Technique et Sociale en agriculture de conservation (PEPITES) and by INRA.

References

- Bond J. J. and Willis, W.O., 1969. Soil water evaporation: surface residue rate and placement effects. *Soil Science Society of America Proceedings*, 33, 445-448
- Findeling A., Garnier P., Coppens F., Lafolie F. and Recous S. 2007. Modeling water, carbon and nitrogen dynamics in soil covered with decomposing mulch. *European Journal of Soil Science* 58, 196-206.

Impact of two different types of grassland-to-arable-conversion on nitrous oxide emission and nitrate leaching

Roth, G.^a, Helfrich, M.^a, Well, R.^a, Flessa, H.^a

^aInstitute of Agricultural Climate Research, Johann Heinrich von Thünen-Institute, Federal Research Institute for Rural Areas, Forestry and Fisheries, Braunschweig, Germany

1. Background & Objectives

Conversion of grassland to arable land often causes enhanced nitrous oxide (N₂O) emissions to the atmosphere (Conen, Dobbie et al., 2000; Grandy and Robertson, 2006) as well as augmented nitrate leaching to the groundwater (Strebel, Böttcher et al., 1988). This is due to the tillage of the sward and subsequent decomposition of organic matter. However, prediction of such effects is uncertain so far because emissions may differ depending on site and soil conditions. We aim to evaluate the impact of grassland-to-field-conversion on N₂O fluxes, mineral nitrogen (N_{min}) content and the eluviation of nitrate. Moreover, we compare two different types of conversion (mechanical and chemical).

2. Materials & Methods

At two sites, in Kleve (North Rhine-Westphalia, Germany, conventional farming, silt loam over clay loam) and Trenthorst (Schleswig-Holstein, Germany, organic farming, sandy silt loam), a four times replicated plot experiment with (i) mechanical conversion (ploughing, maize), (ii) chemical conversion (broadband herbicide, maize per direct seed) and (iii) continuous grassland as reference was started in April 2010. In Trenthorst we established additionally (iv) a continuous field with maize as reference. Over two years, N_{min} content, water content as well as gas emissions were measured weekly. For gas emissions, we used a closed chamber system (Flessa, Dörsch et al., 1995). Soil samples for N_{min} analysis were taken in 0-10cm and 10-30cm depths. In the second year, leachate was sampled in suction cups installed in 35cm depth and analysed for N_{min} and dissolved organic N (DON).

3. Results & Discussion

The time series of N₂O emissions (Figure 1) and N_{min} content (Figure 2) are shown for the Kleve site.

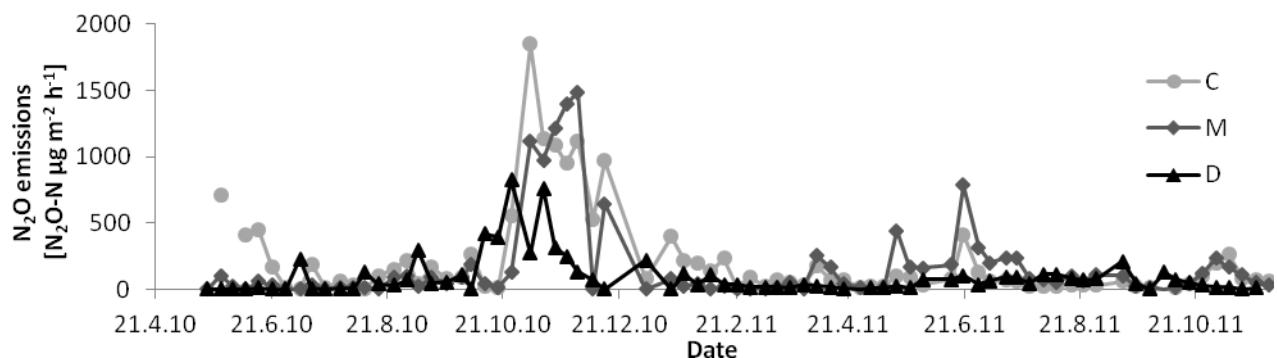

Figure 1. N₂O emissions from Kleve in N₂O-N µg m⁻² h⁻¹ over 1.5 years after conversion (C = chemical conversion, M = mechanical conversion and D = continuous grassland)

The peak emissions of N₂O correlated with the dates of harvest, soil tillage or fertilization in autumn 2010. Increased emissions in the grassland could be due to the wet autumn which was reflected by high water contents. Cumulative N₂O fluxes of the converted grassland were high (6.2

to $25.5 \text{ kg N ha}^{-1} \text{ a}^{-1}$, Table 1). We will also show estimates of nitrate leaching based on the suction cup data (not yet analysed).

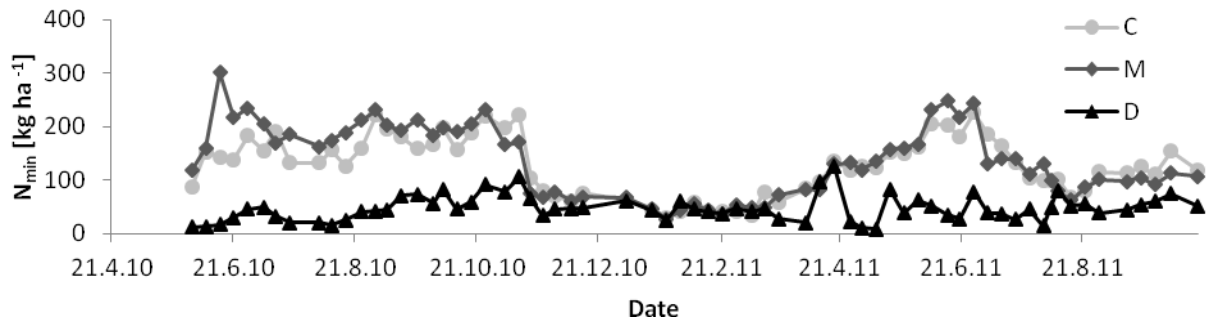

Figure 2. N_{\min} content in 10 - 30 cm depth over two years after conversion (C = chemical conversion, M = mechanical conversion, D = continuous grassland)

We found significant differences between conversion, both, chemical and mechanical, and the reference plots within the first year. While in Kleve were significant differences between the two types of conversion in Trenthorst there was none (Table 1).

Table 1. Interim annual total amount of N_2O emissions in $N_2O-N \text{ ha}^{-1} \text{ a}^{-1}$ and N_{\min} average of the first year from Trenthorst and Kleve in kg ha^{-1} (means of 4 replicates \pm standard error; different uppercase letters indicate significant differences between treatments ($p < 0.05$))

Treatment	Trenthorst [$N_2O-N \text{ kg ha}^{-1} \text{ a}^{-1}$]	Kleve [$N_2O-N \text{ kg ha}^{-1} \text{ a}^{-1}$]	Trenthorst [$N_{\min} \text{ kg ha}^{-1}$]	Kleve [$N_{\min} \text{ kg ha}^{-1}$]
mech. conversion	7.1 ± 0.7^a	15.3 ± 1.82^a	7.3 ± 5.1^a	135.6 ± 65.9^a
chem. conversion	6.7 ± 0.9^a	26.6 ± 2.1^b	14.0 ± 14.7^a	127.0 ± 53.9^a
grassland	1.2 ± 0.2^b	8.8 ± 0.7^a	2.7 ± 2.2^b	46.9 ± 23.9^b
field	2.63 ± 0.4^b		3.5 ± 2.6^b	

4. Conclusions

Following grassland-to-arable-conversion, there was a clear increase in N_2O fluxes within the first two years. The time series of N_2O emissions and N_{\min} was strongly affected by soil tillage and water content. The type of grassland-to-arable-conversion had was significant on one site, but not on the other. The differences between the two sites were mainly due to the different fertilization. We also collected gas samples to analyse isotopic signatures of N_2O to elucidate the processes responsible for elevated N_2O fluxes from the converted grassland.

References

- Conen, F., Dobbie, K. E. and Smith, K. A. 2000. Predicting N_2O emissions from agricultural land through related soil parameters. *Global Change Biology* 6(4), 417-426
- Grandy, A. S. and Robertson, G. P. 2006. Initial cultivation of a temperate-region soil immediately accelerates aggregate turnover and CO_2 and N_2O fluxes. *Global Change Biology* 12(8), 1507-1520
- Strebel, O., Böttcher, J., Eberle, M. and Aldag, R. 1988. Quantitative and qualitative changes in soil properties of A-horizons of sandy soils caused by conversion of grassland to arable land. *Zeitschrift für Pflanzenernährung und Bodenkunde* 151(5), 341-347
- Flessa, H., Dörsch, P. and Beese, F. 1995. Seasonal-variation of N_2O and CH_4 fluxes in differently managed arable soils in southern Germany. *Journal of Geophysical Research-Atmospheres* 100(D11), 23115-23124

Improving N efficiency in barley through green manure management and biogas slurry

Frøseth, R.B.^a, Bakken, A.K.^a, Bleken, M.A.^b, Riley, H.^a, Thorup-Kristensen, K.^c, Hansen, S.^a

^aNorwegian Institute for Agricultural and Environmental Research (Bioforsk), Norway ¹Organic Food and Farming Division, 6630 Tingvoll ; ² Grassland and Forage Crops Division, 7500 Stjørdal; ³ Arable Crops Division, 2849 Kapp

^bDepartment of Plant and Environmental Sciences, University of Life Sciences, 1432 Ås, Norway

^cDepartment of Agriculture and Ecology, Faculty of Life Sciences, University of Copenhagen, 2630 Taastrup, Denmark

1. Background & Objectives

In cereal production on stockless organic farms green manure (GM) is commonly used to improve soil fertility. The clover-grass swards are mown frequently as a means to control perennial weeds in GM-cereal rotations and to keep the ley in a vegetative state, thus avoiding decrease in biomass production and in N₂-fixating activity. The mown GM herbage is commonly mulched (Dahlin et al., 2011). The purpose of this study was to increase knowledge of the N-dynamics in such rotations, in order to suggest methods for improving N efficiency and thus organic cereal yields. The hypothesis was that spring application of biogas residue from anaerobic digestion of GM herbage increases the N uptake and yield of a subsequent barley crop, compared to repeatedly in situ mulching of the same GM herbage in the preceding season.

2. Material & Methods

The effect of various GM treatments on spring barley yields and nitrogen dynamics was investigated, at four sites differing in soil and climatic conditions. The locations were Central Norway (Site 1: silty clay loam and Site 2: sandy loam), Eastern Norway (Site 3: loam) and South-Eastern Norway (Site 4: clay loam). In 2008 a grass clover mixture was undersown in barley. In 2009 the clover-grass herbage was either harvested or mulched. In spring 2010 the GM sward was ploughed down, and barley was sown. Six treatments were compared (Table 1), with four replications. Biogas residue from anaerobically digested GM herbage was applied in spring 2010. It contained 11 g total N and 6 g NH₄-N m⁻² (56 % of the total N in the GM herbage). Two control treatments were included, in which cereals were grown in all three years (without any fertilizer in 2008 and 2009, and with biogas residue or mineral fertilizer in 2010).

Table 1. Overview of treatments.

Treatment	2008	2009	2010
GM+	GMU ^a	GM all harvests mulched	Barley
GM-	GMU ^a	GM all harvests removed	Barley
GM-(B)	GMU ^a	GM all harvests used for biogas	Barley + biogas residue (6 g NH ₄ -N m ⁻²)
GM2/3	GMU ^a	GM first 2 removed, last mulched	Barley
C(B)	Barley	Oats	Barley + biogas residue (6 g NH ₄ -N m ⁻²)
C(M)	Barley	Oats	Barley + mineral fertilizer (8 g N m ⁻²)

^aGMU = Spring barley undersown with green manure.

Soil mineral-N was analysed at 0-0.8 m depth on several occasions from 2008 until spring 2011.

3. Results & Discussion

On average, the mulched or harvested GM herbage contained 19 g N m⁻². In spring 2010, before ploughing down the GM, there was a higher level ($P > 0.001$) of mineral N in soil with GM mulched (GM+) compared with the other treatments at all sites. But two weeks after germination of the barley crop there were no difference in the levels of mineral-N in soil between GM mulched (GM+) and removed (GM-).

Barley dry matter yields in 2010 were approximately 300 g m^{-2} , except in trial 1, where it was only half as high. The use of biogas residue (GM-(B)), raised the nitrogen yield of the barley crop to the same level as of the mulched treatment (GM+). When biogas residue was applied on control plots that had been exhausted by two consecutive cereal crops without any form of fertilization (C (B)) the nitrogen yield of the barley crop reached the same level as the treatment of GM with two of three harvests removed (GM2/3). At sites 1, 2 and 3 barley N yields in 2010 (Figure 1) were 29-38 % lower ($P > 0.001$) when GM herbage was removed (GM- and GM2/3) than when it was mulched (GM+). In these trials, N deficiency symptoms in barley were seen already at the 3rd leaf stage on plots where the GM herbage had been removed. At site 4, there was a similar trend, but the effect was not statistically significant.

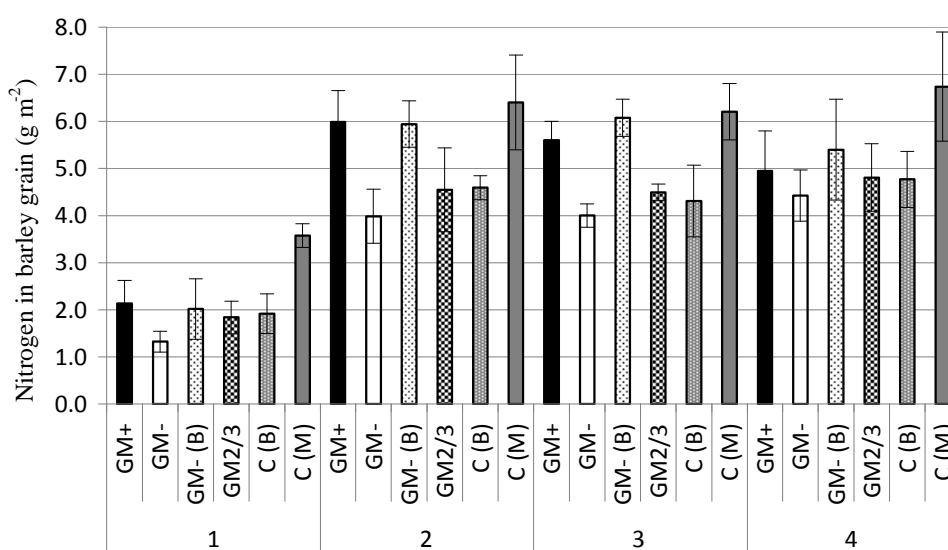

Figure 1. Nitrogen yields of barley grain in 2010 ($\text{g m}^{-2} \pm$ standard deviation) following contrasting green manure treatments in 2009 in four trials. Abbreviations for green manure treatments are explained in Table 1.

In spring 2011 there was a higher level ($P > 0.001$) of $\text{NO}_3\text{-N}$ in soil with GM in 2009 than without, but no effect of the different GM treatments was seen in $\text{NH}_4\text{-N}$ content.

4. Conclusions

The results suggest that, under the Norwegian climate, mulching of GM herbage can increase cereal yields compared to its removal, depending on soil type and rotation history. However, the use of GM herbage for biogas production appears to be much more N-efficient on farm level. We applied about half of the N available in GM herbage, and the surplus residue makes it possible to manure other fields.

References

Dahlin A.S., Stenberg M. and Marstorp H. 2011. Mulch recycling in green manure leys under Scandinavian conditions, *Nutrient Cycling in Agroecosystems* 91:119-129.

Influence of fertilisation practice on gas and grain yield production

Bálint Á.^a, Hoffmann S.^b, Berecz K.^{†b}, Kristóf K.^a, Kampfl Gy.^a, Nótás E.^a, Horváth M.^a, Gyarmati B.^a, Molnar E.^a, Anton A.^c, Szili-Kovács T.^c, Heltai Gy.^a

^aDepartment of Chemistry and Biochemistry, Szent István University, Gödöllő, Hungary

^bInstitute of Plant Production and Soil Sciences, University of Pannonia, Keszthely, Hungary

^cInstitute for Soil Sciences and Agricultural Chemistry, Centre for Agricultural Research, MTA, Budapest, Hungary

1. Background & Objectives

CO₂, N₂O, CH₄ and NO emissions are studied extensively (Akimoto et al., 2005; Mørkved et al., 2006; Ruser et al., 2006) because their presence in air causes environmental problems e.g. global warming and stratospheric ozone depletion. To explore the role of fertilisation practices to this phenomenon, experimental examinations of soil gas emission with different scales have particular importance. Hence, the objective of our research was to investigate this complex relationship by comparing the effects of organic and mineral fertilisers on GHG emission and grain yield production. The research project started in 2007 was realized at four levels: in long term field, mesocosm, microcosm and column experiments. The GHG emissions from the different experimental setup were compared and analyzed. In this paper only part of the soil column experiment (2010) is presented.

2. Materials & Methods

Six undisturbed soil columns were taken from the set-aside (Eutric Cambisol soil) at Keszthely, Hungary (46°40' N; 17°15' E). The columns were 90 cm high and 40 cm in diameter. Soil texture was a sandy loam with low organic matter and P content and medium K content, pH_(KCl) = 7.1. The soil columns had different fertilization treatments: 1. control without maize seeding and fertilisation (0), 2. 105 Mg hectare⁻¹ equivalent NPK fertilisation without maize seeding (NPK), 3. control with maize seeding (M), 4. maize seeding and 105 Mg hectare⁻¹ equivalent NPK (M+NPK), 5. maize seeding and farmyard manure, 105 Mg hectare⁻¹ equivalent (M+FYM), 6. maize seeding and 105 Mg hectare⁻¹ NPK fertilisation plus 105 Mg hectare⁻¹ NPK equivalent farmyard manure (M+NPK+FYM). Soil surface CO₂ fluxes were measured by gas sampling from a closed-chamber inserted into the top of each column at zero and at 30 minute after closure. Gas samples were taken each time at about 8 a.m. by a gas-tight syringe and injected into evacuated Exetainer tubes (Labco Limited, UK). The gas concentrations were measured by gas chromatograph (HP 5890, equipped with Porapak Q column to measure carbon dioxide, which was detected by thermal conductivity). Soil samples were also taken to measure active microbial biomass by substrate-induced respiration (SIR) and microbial activity based on fluorescein-diacetate hydrolysing activity (FDA).

3. Results & Discussion

Treatments had significant effect on SIR and FDA (Figure 1) although the effects of individual treatments could not be distinguished. Manure treatments caused significantly higher microbial biomass and activity during summer. On the other hand the presence of maize did not clearly appeared in the SIR and FDA values. We established significant correlation between SIR and FDA ($r = 0.596$; $p = 0.0001$). Three peaks of CO₂ fluxes (Figure 2) were observed during the 141 day long period, the first between 9th and 11th days after seeding of maize, the second on 86th day (21th July) in all treatments while on 37th (2nd June) only at manure treatments. The mean values of CO₂ fluxes varied between 21 and 2052 mg CO₂ m⁻² hour⁻¹. The correlation between surface CO₂ flux and SIR was marginally significant ($r = 0.302$; $p = 0.073$) while between CO₂ flux and FDA was significant ($r = 0.47$; $p = 0.004$).

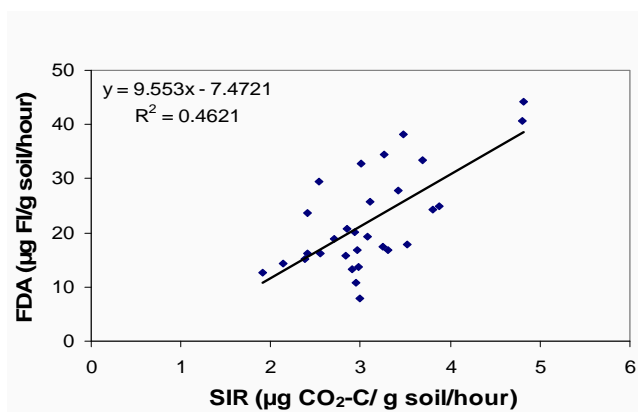
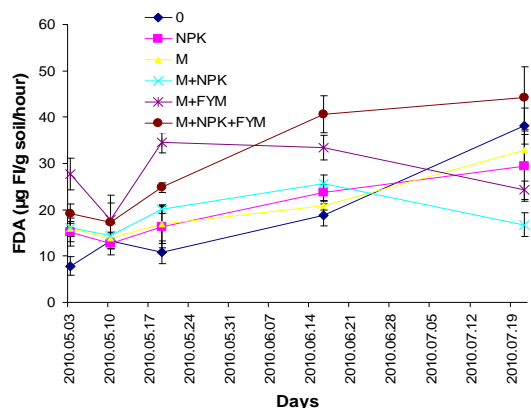

Figure 1. Fluorescein-diacetate hydrolysing (FDA) activity in surface soil samples during the vegetation season (0 = control; NPK = NPK treatment; M = presence of maize plant; FYM= farmyard manure) and linear regression between SIR and FDA in all soil samples in soil column experiment.

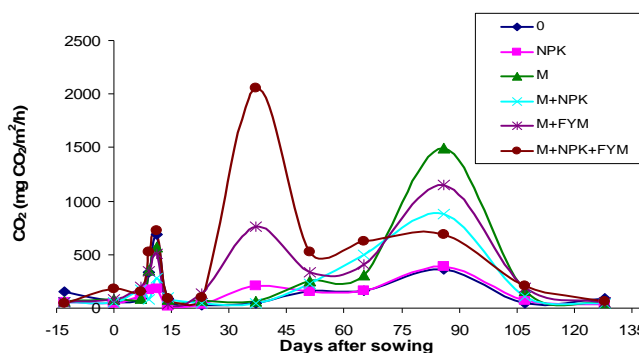

Figure 2. Sampling of gas and surface CO₂ flux from soil columns during the vegetation season from 13th April till 1st September (0 = control; NPK = NPK treatment; M = presence of maize plant; FYM= farmyard manure).

4. Conclusions

Treatments had significant effects on surface CO₂ flux, SIR and FDA, and they were in correlation with each other. The highest CO₂ flux, SIR and FDA were found in the combined NPK+FYM treatment.

Acknowledgement

The National Scientific Research Fund supported this work (OTKA K: 72926, 73326, 73768).

References

- Akimoto, F., Matsunami, A., Kamata, Y., Kodama, I., Kitagawa, K., Arai, N., Higuchi, T., Itoh, A. and Haraguchi, H. 2005. Cross-correlation analysis of atmospheric trace concentrations of N₂O, CH₄ and CO₂ determined by continuous gas-chromatographic monitoring. *Energy* 30, 299-311.
- Mørkved, P.T., Dörsch, P., Henriksen, T.M. and Bakken, L.R. 2006. N₂O emissions and product ratios of nitrification and denitrification as affected by freezing and thawing. *Soil Biology and Biochemistry* 38, 3411-3420.
- Ruser, R., Flessa, H., Russow, R., Schmidt, G., Buegger, F. and Munch, J.C. 2006. Emission of N₂O, N₂ and CO₂ from soil fertilized with nitrate: effect of compaction, soil moisture and rewetting. *Soil Biology and Biochemistry* 38, 263-274.

Influence of soil amendment history on decomposition of recently applied organic amendments

Nett, L.^a, Ruppel, S.^a, Ruehlmann, J.^a, George, E.^a, Fink, M.^a

^aLeibniz-Institute of Vegetable and Ornamental Crops Großbeeren and Erfurt

1. Background & Objectives

Long-term organic amendment, compared to the absent or solely mineral fertilization, can increase the microbial biomass content in soil (Gunapala and Scow, 1998), change the microbial community structure (Dambreville et al., 2006), and enhance the activities of certain enzymes (Carpenter-Boggs et al., 2000). However, it is not clear whether long-term amendment results in the modified decomposition rates of newly added organic matter. The literature does not give a consistent answer to this question (Fauci and Dick, 1994; Hadas et al., 1996; Mallory and Griffin, 2007). Hence, the objective of this study was to examine whether potential amendment history effects on decomposition of recently applied material depend on the amendment chemical characteristics.

2. Materials & Methods

The soil was taken from a field experiment (Ruehlmann, 2006) where different amendment treatments had been applied to one original soil (loamy sand) since 1973: unfertilized control (HCO), solid farmyard manure (HFM), pine bark (HPB), and crop residues of the previous crop (HCR), referred to as amendment history treatments (prefix "H"). One composite samples of 24 subsamples was obtained per treatment. These four soil materials were mixed in bulk with either: nothing (RCO), farmyard manure (RFM), pine bark (RPB), or crop residues (RCR) at a rate equivalent to 2 mg C g⁻¹ dry soil, hereafter referred to as recent amendment treatments (prefix "R"). In a 147-day laboratory incubation experiment, net CO₂-C release (Δ CO₂-C; 5 replications) and net changes in soil mineral N (Δ SMN; 3 replications) and microbial biomass carbon (Δ MBC; 3 replications) contents were determined.

3. Results & Discussion

In the case of amendment history effects on the decomposition of recently added amendment, significant interactions between the factors amendment history and recent amendment were expected to be revealed in the two-way ANOVA. Such interactions were only detected in Δ SMN at day 3 and 78 (Table 1). In these cases, however, no consistent effect of amendment history on the decomposition of recently applied amendments was revealed by linear contrasts. Moreover, at day 147, the same trend (HCO < HPB = HCR < HFM; Tukey's HSD) was exhibited in Δ SMN irrespective of recent amendment treatment (Table 1). This pattern was in concurrence with soil total N and C contents, initial microbial biomass C and initial soil mineral N (Fig. 1). These results were consistent with those of Hadas et al. (1996) and Langmeier et al. (2002), who found that differences in net N mineralization were mostly due to differences in N mineralization from previously existing soil organic matter. In Δ MBC and Δ CO₂-C, there were no interactions between the two main factors at any of the measurement dates (Table 1). This was in accordance with results of Fauci and Dick (1994), who showed that the microbial biomass of the different soils did not respond differently to different recent amendment treatments. In conclusion, the results indicate that amendment history effects on the decomposition of recently applied amendments, if present, are too small to be relevant to fertilization practice. One explanation could be the capability of soil microorganisms to quickly respond to changes in substrate availability by adjusting both metabolic activity and microbial community structure.

Table 1. Two-way ANOVA results (p-values) for the effects of amendment history (H), recent amendment (R), and their interaction (H x R) on Δ MBC, Δ SMN, and Δ CO₂-C. † Data transformed using a Box-Cox transformation. ‡ Prerequisites for ANOVA were not achieved at $\alpha = 0.01$. p-values < 0.05 are shown in bold. n.a. Not applicable.

Measure	Effect	Days after start of incubation				
		0	3	9	78	147
Δ MBC	H	0.6515 †	0.5985 †	0.9270 †	0.5253	0.0365
	R	<0.0001 †	<0.0001 †	<0.0001 †	0.0065	0.0006
	H x R	0.7732 †	0.1140 †	0.9918 †	0.6748	0.9855
Δ SMN	H	0.1081 †	0.0044	‡	<0.0001 †	<0.0001
	R	<0.0001 †	<0.0001	‡	<0.0001 †	<0.0001
	H x R	0.2269 †	<0.0001	‡	<0.0001 †	0.3410
Δ CO ₂ -C	H	n.a.	0.1706 †	0.3699 †	0.0001 †	0.0043
	R	n.a.	<0.0001 †	<0.0001 †	<0.0001 †	<0.0001
	H x R	n.a.	0.2737 †	0.2789 †	0.0594 †	0.2155

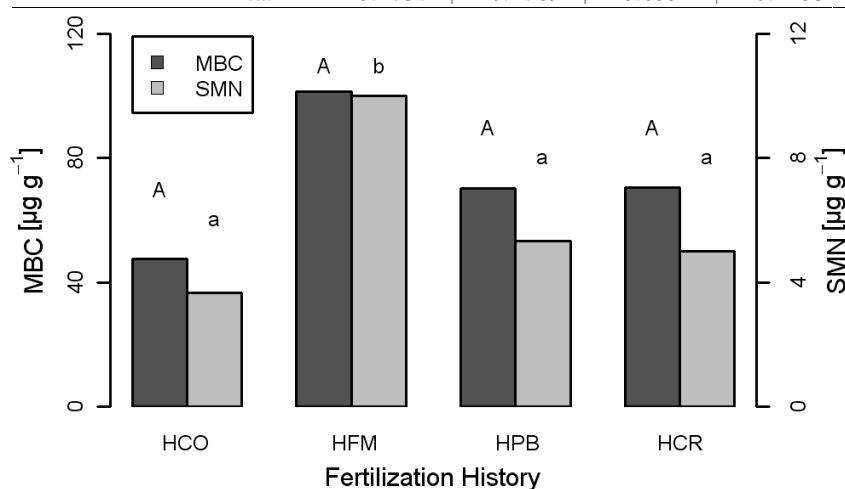

Figure 1. Initial values of microbial biomass C (MBC) and soil mineral N (SMN) contents in $\mu\text{g g}^{-1}$ dry soil. Different letters above the columns indicate significant ($p < 0.05$) differences between amendment history treatments in MBC (upper case) and in SMN (lower case), respectively.

References

- Carpenter-Boggs L., Kennedy A.C. and Reganold J.P. 2000. Organic and biodynamic management: Effects on soil biology. *Soil Science Society of America Journal* 64, 1651-1659.
- Dambreville C., Hallet S., Nguyen C., Morvan T., Germon J.C. and Philippot L. 2006. Structure and activity of the denitrifying community in a maize-cropped field fertilized with composted pig manure or ammonium nitrate. *FEMS Microbiology Ecology* 56, 119-131.
- Fauci M.F. and Dick R.P. 1994. Soil microbial dynamics: Short-term and long-term effects of inorganic and organic nitrogen. *Soil Science Society of America Journal* 58, 801-806.
- Gunapala N. and Scow K.M. 1998. Dynamics of soil microbial biomass and activity in conventional and organic farming systems. *Soil Biology & Biochemistry* 30, 805-816.
- Hadas A., Kautsky L. and Portnoy R. 1996. Mineralization of composted manure and microbial dynamics in soil as affected by long-term nitrogen management. *Soil Biology & Biochemistry* 28, 733-738.
- Langmeier M., Frossard E., Kreuzer M., Mader P., Dubois D. and Oberson A. 2002. Nitrogen fertilizer value of cattle manure applied on soils originating from organic and conventional farming systems. *Agronomie* 22, 789-800.
- Mallory E.B. and Griffin T.S. 2007. Impacts of soil amendment history on nitrogen availability from manure and fertilizer. *Soil Science Society of America Journal* 71, 964-973.
- Ruehlmann J. 2006. The box plot experiment in Grossbeeren after six rotations: Effect of fertilization on crop yield. *Archives of Agronomy and Soil Science* 52, 313-319.

Influence of N deposition and atmospheric O₃ concentration on N₂O and NO emissions from Mediterranean pastures.

Sanchez-Martin, L.^a, de la Cruz Lopez, A.^a, Garcia-Torres, L.^a, Calvete, H.^b, García, H.^b, Gonzalez, I.^b, Bermejo, V.^b, Vallejo, A.^a

^aETSI Agrónomos, Technical University of Madrid, Ciudad Universitaria. 28040 Madrid, Spain.

^bEcotoxicity of Air Pollution, CIEMAT, Madrid, Spain.

1. Background & Objectives

Pastures are among the most important ecosystems in Europe considering their high biodiversity and their coverage in the European territory (8 %). Previous studies have shown that in the last decades, tropospheric ozone (O₃) produced primarily by atmospheric pollution, and nitrogen (N) deposition, significantly affect these ecosystems altering their structure and composition (Sanz et al., 2007). The greenhouse gas nitrous oxide (N₂O) and the photochemical oxidant nitric oxide (NO) have increased during recent years, mostly as a result of management of natural and agricultural soils. The magnitude of these emissions, promoted by nitrification and denitrification processes, depends on substrate availability (mineral N), climate and soil properties. However, the effect that the combination of both tropospheric ozone and nitrogen deposition has on nitrogen emissions in a Mediterranean pasture ecosystem is largely unknown. Our objective was to quantify the N₂O and NO emissions from a Mediterranean pasture for three different levels of N deposition under different ozone concentrations.

2. Materials & Methods

The experiment was carried out from April to June 2011 in “La Higuera/CSIC” field station located in Toledo (Spain). An Open Top Chamber (OTC) technique was used to establish the different O₃ concentrations: [unfiltered air (ANF), unfiltered air + 40 ppb of ozone (AFU), unfiltered air + 60 ppb of ozone (AFU+) and control plots without OTC (AC)]. Six plant species, representative of a typical annual pasture, were sown inside the chambers and given four applications of N fertilizer (NH₄NO₃), with one application every 15 days. Different rates of fertilizer were applied to simulate different levels of atmospheric N deposition (0, 20 and 40 kg N ha⁻¹ corresponding to the treatments N-0, N-20 and N-40, respectively). Emissions of N₂O were measured by the static chamber technique and analysed by gas chromatography (Sanchez-Martin et al., 2010) and a flow through system was used to measure NO emissions by chemiluminescence (Roelle et al., 1999). Soil parameters such as WFPS, mineral N and temperature were also measured (Sanchez-Martin et al., 2010).

3. Results & Discussion

Total N₂O emissions were not affected by different rates of N deposition (Figure 1a). According to Skiba et al. (1998) it is necessary to exceed the threshold of 40 kg N ha⁻¹ y⁻¹ if the soil was not previously exposed to high rates of N inputs. Some negative N₂O fluxes were observed, especially for the treatments which were exposed to ambient concentrations of ozone (ANF and AC), which also shows that there was no effect of the OTC.

Contrary to some studies (Kanerva et al., 2006; Bhatia et al., 2011), increasing tropospheric ozone (AFU+) increased N₂O emissions. On the other hand, NO emissions were mainly affected by the different levels of N deposition but not the O₃ concentrations (Figure 1b). According to Kanerva et al. (2007), the impact of elevated O₃ on the production and consumption of trace gases is not well

understood and has not been assessed in natural or semi-natural grasslands. To date, very few studies have looked at the combined affects of N and O₃ on below-ground processes that may be important for the global atmospheric budgets of these gases, especially in climates with extreme seasonal weather variations such as the Mediterranean climate.

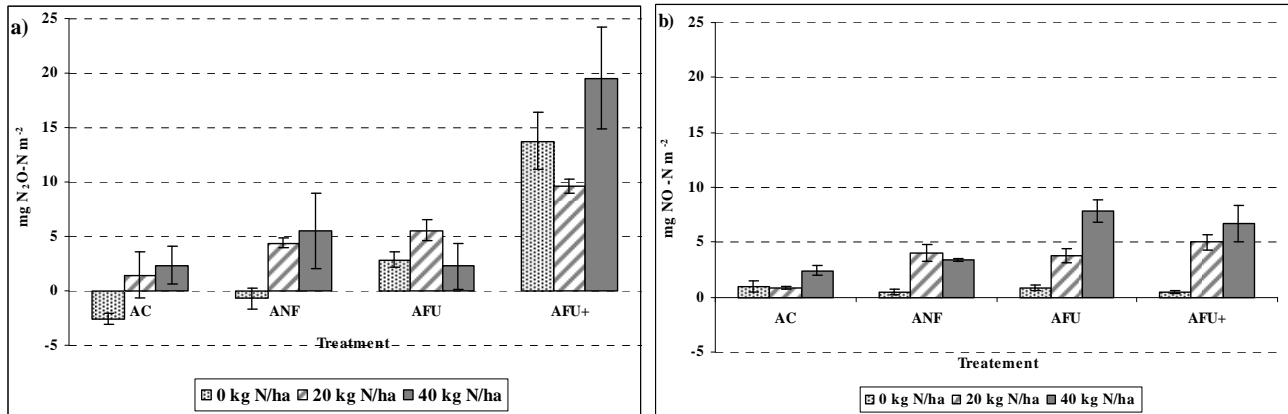

Figure 1. Total N₂O (a) and NO (b) emissions from different O₃ and N treatments at the end of the experimental period.

4. Conclusion

Deposition of atmospheric N significantly increased NO emissions, although there were no significant differences between the values for different deposition rates.

By contrast, N₂O emissions were not affected by N deposition but emissions increased when atmospheric O₃ concentration reached 60-80 ppb.

Moderately enhanced O₃ concentrations and N deposition rates appear to alter N₂O and NO emissions but longer measurement periods are required to verify these interactions in Mediterranean pasture ecosystems.

References

- Bhatia, A., Ghosh, A., Kumar, V., Tomer, R., Singh, S.D. and Pathak, H. 2011. Effect of elevated tropospheric ozone on methane and nitrous oxide emission from rice soil in north India. *Agriculture, Ecosystems and Environment* 144, 21-28.
- Kanerva, T. 2006. Below-ground processes in meadow soil under elevated ozone and carbon dioxide - Greenhouse gas fluxes, N cycling and microbial communities. Thesis. University of Helsinki, Faculty of Biosciences, Department of Biological and Environmental Sciences and MTT, Agrifood Research Finland
- Kanerva, T., Regina, K., Rämö, K., Ojanperä, K. and Manninen, S., 2007. Fluxes of N₂O, CH₄ and CO₂ in a meadow ecosystem exposed to elevated ozone and carbon dioxide for three years. *Environmental Pollution* 145, 818-828
- Roelle, P., Aneja, V. P., O'Connor, J., Robarge, W., Kim, D. and Levine, J. S. 1999. Measurement of nitrogen oxide emissions from an agricultural soil with a dynamic chamber system. *Journal of Geophysical research* 104, 1609-1619.
- Sanz, J., Bermejo, V., Gimeno, B.S., Elvira, S. and Alonso, R. 2007. Ozone sensitivity of the Mediterranean terophyte *Trifolium striatum* is modulated by soil nitrogen content. *Atmospheric Environment* 41, 8952-8962.
- Sanchez-Martin, L., Sanz-Cobena, A., Meijide, A., Quemada, M. and Vallejo, A. 2010. The importance of the fallow period for N₂O and CH₄ fluxes and nitrate leaching in a Mediterranean irrigated agroecosystem. *European Journal of soil Science* 61, 710-720.
- Skiba, U., Sheppard, L., Pitcairn, C.E.R., Leith, I., Crossley, A., van Dijk, S., Kennedy, V.H. and Fowler, D. 1998. Soil nitrous oxide and nitric oxide emissions as indicators of the exceedance of critical loads of atmospheric N deposition in seminatural ecosystems. *Environmental Pollution* 102, S1, 457-461

Influence of soil water status and compaction on N₂O and N₂ emissions from ¹⁵N-labelled synthetic urine.

Harrison-Kirk, T.^a, Thomas, S.M.^a, Beare, M.H.^a, Clough, T.J.^b, van der Weerden, T.J.^c, Meenken, E.D.^a

^aNew Zealand Institute for Plant & Food Research, Private Bag 4704, Christchurch 8140, New Zealand.

^bDepartment of Soil and Physical Sciences, PO Box 7647, Lincoln University, Canterbury, New Zealand.

^cAgResearch Invermay, Private Bag 50034, Mosgiel, New Zealand.

1. Background & Objectives

Animal excreta deposition is New Zealand's largest source of nitrous oxide (N₂O) emissions, representing 50% of direct N₂O emissions (de Klein et al., 2003). Denitrification is considered the main process of N₂O production from these pasture soils. Soil water status is a key determinant of these emissions as it influences air-filled porosity and oxygen diffusion into and through the soil. Soil compaction is an important factor affecting these processes. The aim of this research was to develop a better understanding of the role that soil physical characteristics and changing soil water status during drainage play in regulating both N₂ and N₂O emissions from urine patches, using ¹⁵N-labelled synthetic urine. This knowledge will be used to develop practical tools for predicting when there is greatest risk of N₂O emissions from urine patches.

2. Materials & Methods

Repacked soil cores (Typic Orthic Allophanic Soil) were compacted at pressures of 0, 220 kPa & 400 kPa and treated with or without ¹⁵N-labeled synthetic urine applied at 600 kg N ha⁻¹ (enrichment of 50 atom%). Soil cores were then subjected to three successive, 12-day saturation/drainage cycles (from 0 to -10 kPa tension). Daily gas fluxes of N₂O, N₂ and CO₂ were quantified using mini-headspace chambers placed over the cores. Soils sampled prior to commencing the 2nd and 3rd cycles and on completion of the experiment were analysed for inorganic-N, dissolved organic-C (DOC) and pH.

3. Results & Discussion

The ratio of N₂O to N₂ emitted during denitrification depends on factors such as soil pH, soil water status, NO₃-N concentration and C supply (Clough et al., 2004). During the 1st drainage cycle, nitrification was limited by a lack of O₂ due to low gas diffusion through the core at high water contents (mean WFPS over cycle 1 of 82, 84 & 86% for 0, 220 & 400 kPa compaction respectively) and the high microbial O₂ consumption stimulated by high DOC levels (485, 530 and 695 mg kg⁻¹ for 0, 220 and 400 kPa compaction respectively). Hence, the supply of NO₃⁻ for denitrification was low (< 25 µg NO₃-N g⁻¹); at low NO₃⁻ concentrations, N₂O was rapidly reduced to N₂ (Figure 1, cycle 1). In the 2nd cycle, soil NO₃-N concentration began to increase (Figure 2, day 12). N₂ was still the predominant product (Figure 1, cycle 2) probably due to complete denitrification when NO₃⁻ supply is limited, high soil pH (pH >6.5) and high water filled pore space (WFPS) (ranging from 92 to 74%) that restricted diffusion of N₂O from the site of denitrification allowing further reduction to N₂. By the 3rd cycle NO₃-N concentrations had further increased (Figure 2, day 24) and N₂O was the predominant emission product from the 0 and 220 kPa compaction treatments, while N₂O and N₂ were emitted at similar rates from the 400 kPa treatment (Figure 1, cycle 3). Higher WFPS at any given tension, higher pH and lower NO₃⁻ concentration in the 400 kPa treatment would have favoured N₂ emissions compared to the 0 and 220 kPa treatments.

4. Conclusions

Compaction of urine amended soils changed the soil water and porosity characteristics that affected gas diffusion into and out of the soil. This affected nitrification rates, the timing of emissions and ratio of gas products over a series of drainage cycles.

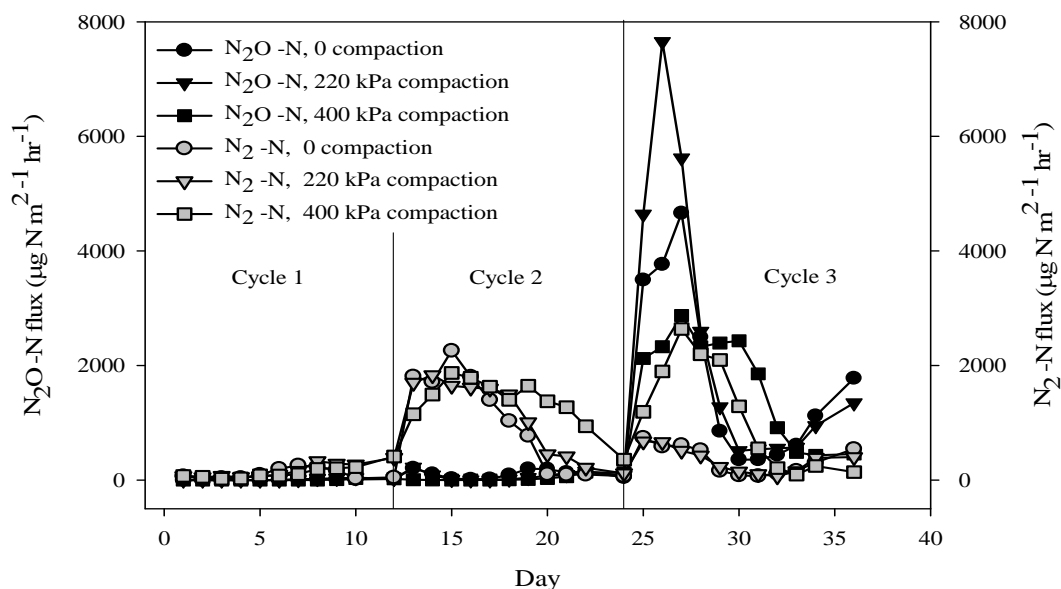

Figure 1. Daily flux rates of N_2 - and N_2O -N from the three compaction treatments over the course of the three saturation-drainage cycles.

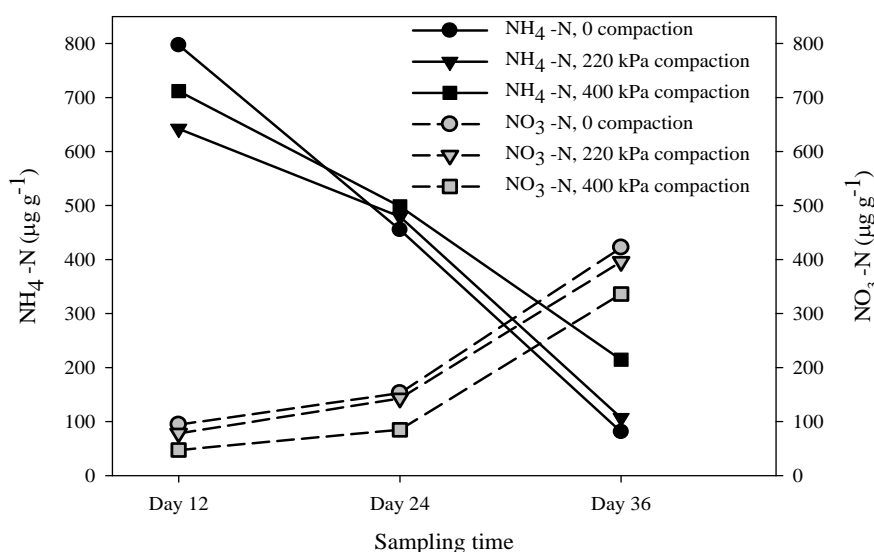

Figure 2. Changes in NH_4 - and NO_3 -N concentrations over the course of the experiment for the three compaction treatments.

References

- Clough, T.J., Kelliher, F.M., Sherlock, R.R. and Ford, C.D. 2004. Lime and soil moisture effects on nitrous oxide emissions from a urine patch. *Soil Science Society of America Journal* 68, 1600-1609.
- de Klein, C.A.M., Barton, L., Sherlock, R.R., Li, Z. and Littlejohn, R.P. 2003. Estimating a nitrous oxide emission factor for animal urine from some New Zealand pastoral soils. *Soil Research* 41, 381-399.

Influence of tree canopies on nitrogen dynamics in Montado - a Portuguese Cork Oak Savanna

Fangueiro, D.^a, Caldeira, M.C.^b, Lecomte, X.^b, Coutinho, J.^c

^a UIQA, Instituto Superior de Agronomia – Technical University of Lisbon, 1349-017 Lisbon, Portugal

^b CEF, Instituto Superior de Agronomia – Technical University of Lisbon, 1349-017 Lisbon, Portugal

^c Centro de Química, Universidade de Trás-os Montes e Alto-Douro, 5001-801 Vila Real, Portugal

1. Background and Objectives

Montado, Portuguese Cork Oak Savanna, is composed of a sparse tree canopy (30-70 trees/ha) and a grassland. The sustainability of such system depends on soil nitrogen (N) availability, particularly on N mineralization. This process is affected by several soil characteristics such as water or carbon content but also by the vegetation. Two distinct types of plant litter, herbaceous litter and more recalcitrant woody plant litter can be found in Montado. The main objective of the present work was to assess the differences in N turnover and N availability in soils under tree canopies compared to open grassland soils. To achieve this goal, the spatial and temporal variability of nitrogen dynamics (mineralization) and soil microbial biomass due to the tree-grassland component of Montado were evaluated.

2. Materials & Methods

The study site is a Montado located in Southern Portugal close to Lisbon. At this site 8 plots were randomly established under mature Cork oak trees and paired with 8 open grassland plots. During one year (from May 2009 to May 2010) soil cores (0-10 cm) were collected monthly at each site for soil mineral N and microbial biomass N determinations, along with potential N mineralization. Methodologies used here were as described in McCulley et al. (2004).

3. Results & Discussion

Soil moisture availability in Montado is highly seasonal with a dry season from May to September and a short period of high rainfall and cool temperatures in winter, with some precipitation also occurring in spring and autumn. Soil ammonium concentrations were greater under the canopy than in open grassland soils from September to March but no differences were observed in other months where values remained constant and lower than 0.6 mg N kg^{-1} dry soil (Figure 1). Soil nitrate concentrations were higher in open grassland ($0.80\text{--}6.36 \text{ mg N kg}^{-1}$ soil) than under canopy soils ($0.22\text{--}2.15 \text{ mg N kg}^{-1}$ soil) from June to September. In both areas, total inorganic N concentration in the soil varied significantly ($P < 0.05$) over time.

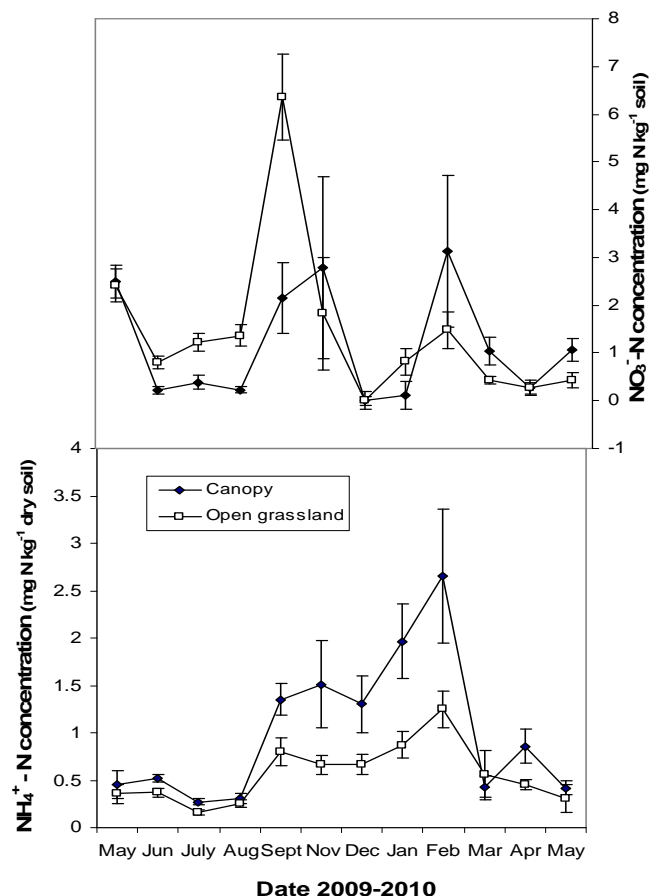

Figure 1. Nitrate and ammonium concentration in open grassland and under canopy soils (means + SE)

By the end of the summer, nitrate had accumulated while NH_4^+ had decreased and the opposite situation occurred by the end of January. Nitrogen uptake by plants during the summer season led to low N concentrations in soil whereas in winter, N accumulation occurred, due to low N uptake by plants. Nitrogen mineralization was low from May until August with no differences between the two areas, but it increased with the first rain events in September (Figure 2). Previous work (Shekhar Singh et al., 2007) has also reported an increase in N mineralization after rewetting of dry soil. The potential N mineralization was higher in areas under the tree canopy than in open grassland between September and March. The observed seasonal and spatial variations in potential N mineralization were attributed to variations in soil organic matter, temperature and soil water availability.

The microbial biomass N (MBN) was higher in tree canopy areas than in open grassland except in December (Figure 3). Values of MBN peaked in November in tree canopy soils and only in December in open grassland soils. MBN values remained constant in both areas from May to September. Previous studies (Diaz-Ravina et al., 1995; Devi and Yadava, 2006) have also reported a maximum value of MBN in wet period and a minimum in dry period.

4. Conclusions

The tree density in Montado can be increased since higher N availability and mineralization was observed in area under the tree canopy. Nevertheless, equilibrium between tree and grassland area has to be maintained to allow efficient N and C fluxes between areas.

References

- Devi, N.B. and Yadava, P.S. 2006. Seasonal dynamics in soil microbial biomass C, N and P in a mixed-oak forest ecosystem of Manipur-North-east India. *Applied Soil Ecology* 31, 220-227.
- Diaz-Ravina, M., Acea, M.J. and Carballas, T. 1995. Seasonal changes in microbial biomass and nutrient flush in forest soils. *Biology and Fertility of Soils* 19, 220-226
- McCulley, R.L., Archer, S.R., Boutton, T.W., Hons, F.M. and Zuberer, D.A. 2004. Soil respiration and nutrient cycling in wooded communities developing in grassland. *Ecology* 85(10), 2804-2817.
- Shekhar, Singh R., Tripathi, N. and Singh, S.K. 2007. Impact of degradation on nitrogen transformation in a forest ecosystem of India. *Environmental Monitoring Assessment* 125,165-173.

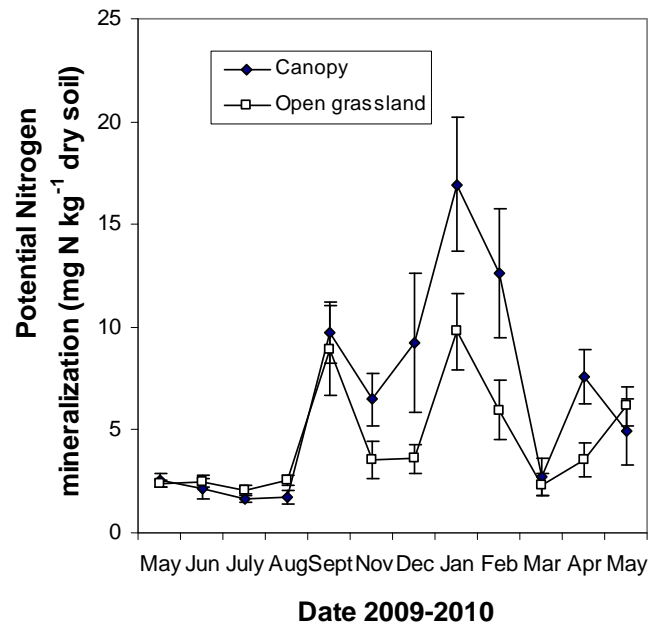

Figure 2. Potential of N mineralization in open grassland and under canopy soils (means + SE) soils in April 1984.

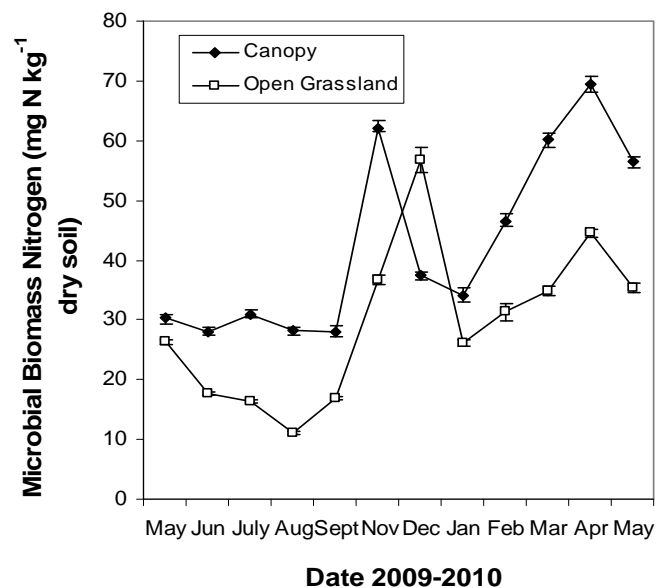

Figure 3. Microbial biomass nitrogen in open grassland and under canopy soils (means + SE)

Interactions between Free-living Soil Nematodes and Ryegrass: Effects on Nitrogen Mineralization

Gebremikael, M.T.^a, Buchan, D.^a, De Neve, S.^a,

^aDepartment of Soil Management, Faculty of Bioscience Engineering, Gent University, Gent, Belgium

1. Background & Objectives

Free-living nematodes have been estimated to contribute 8-19% to total N mineralization in soil (Neher and Power, 2005). These results are based on theoretical food web calculations (Hunt et al., 1987) or very simplified experiments including only a few selected species, often on sterilized media (Ferris et al., 1998). However, N mineralization is controlled by biological interactions between microbes, fauna and plants. To address this issue we conducted an incubation experiment with and without plants, by re-inoculating entire nematode populations into soil cores that had been defaunated using low-dose gamma irradiation which selectively kills fauna while minimally disturbing the microbial population. The objective of this experiment was to investigate the effect of interactions among different feeding groups of free-living soil nematodes, microbes and plants on nitrogen mineralization.

2. Materials & Methods

Part of the fresh soil samples collected were gamma irradiated at a 5 kGy dose in order to kill nematodes and other soil fauna. Entire populations of free-living nematodes were extracted from bulk soil using an automated zonal centrifugal machine (Hendrickx, G. 1995) and re-inoculated into cores that had been filled with defaunated soil. Three treatments, each with four replicates, were compared on soil either left bare or planted with *Lolium perenne*: (i) not irradiated and not inoculated (control) which mainly used for comparing nematode population and dynamics, (ii) defaunated and reinoculated (+Nem), and (iii) defaunated but not re-inoculated (-Nem). The moisture content was adjusted to 50% of the water filled pore space and kept constant by adding distilled water every day. Dynamics of mineral N in soil, plant N uptake, microbial biomass carbon (MBC), and nematode population were determined destructively after 7, 30, 45, 65, and 86 days of incubation in a growth chamber (17°C and 16/8 light/dark hours). Due to the influence of plant uptake on N dynamics in planted microcosms, total mineral N was considered as the sum of mineral N that was found in the soil and taken up by the grass shoots and roots. Two way ANOVA, with two fixed factors: time versus treatment; and palnting versus treatment were separately run to analyze all the parameters and palnt-nematode interactions respectively. Whenever there was significant mean differences ($P < 0.05$), Games-Howel post hoc analysis was used in SPSS version 19.

3. Results & Discussion

The nematodes population after reinoculation was compared to the control in order to check the efficiency of re-inoculation. At the beginning of incubation the efficiency was found to be 67.4% and 49.5% in bare and planted microcosms respectively. But after 65 days of incubation, the population was found to be higher ($P < 0.05$) in +Nem samples than the control in planted microcosms. Total mineral N in bare microcosms was found to be significantly ($P < 0.05$) higher in +Nem samples as compared to -Nem samples (Figure 1). Similarly $\text{NO}_3\text{-N}$ concentration was found to be significantly ($P < 0.05$) higher in +Nem samples towards the end of the incubation period. Xiao et al. (2010) reported that bacterial feeding nematodes increased ammonia-oxidizing bacterial community which could explain the increased nitrate concentrations. In contrast to bare

microcosms, no significant difference ($p > 0.05$) in total mineral N was found between +Nem samples and -Nem samples in planted microcosms (Figure 1). Plant versus treatment interactions were found statistically significant ($p < 0.05$) for -Nem samples.

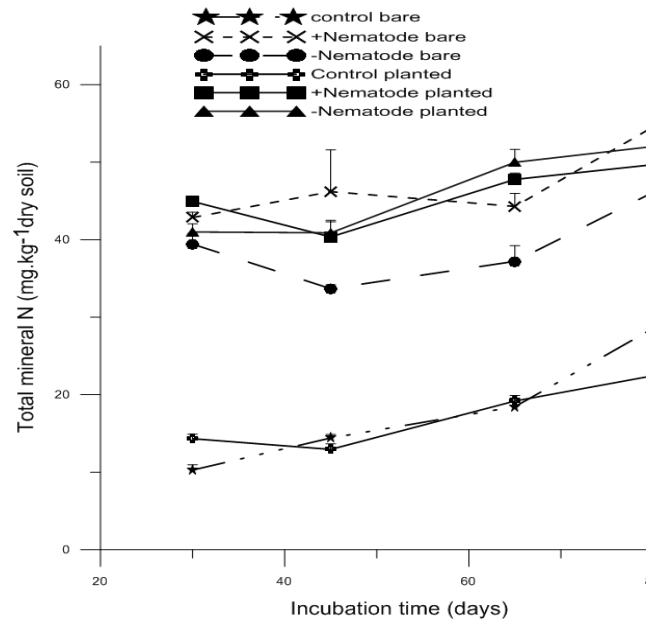

Figure 1. Dynamics of total mineral N over the incubation period. The error bars are standard error of the mean ($n=4$).

Previous investigations reporting increased plant N uptake used only few species of nematodes under sterilized conditions (Ingham et al., 1985). Here, inoculating the entire nematode population instead of few species, which normally consist of plant parasitic nematodes, might have affected N uptake in plants. Data on the composition of the microbial and nematode populations and enzymatic activities is currently being processed.

4. Conclusion

Free-living soil nematodes communities can increase nitrification and N mineralization in bare microcosms. The results show that the presence of the entire free living nematodes did not significantly affect total mineral N in the planted microcosms. Data on the functional feeding groups of these nematodes is required to possibly explain the mechanism responsible for the effects of nematodes on N mineralization and plant uptake.

References

- Ferris, H. et al. 1998. Nitrogen mineralization by bacterial-feeding nematodes: verification and measurement. *Plant Soil* 203, 159-171
- Hunt, H. W. et al. 1987. The detrital food web in a shortgrass prairie, *Biol. Fertil. Soils* 3, 57-68
- Ingham, R. E., Trofymow, J. A., Ingham, E. R. and Coleman, D. C. 1985. Interactions of bacteria, fungi and their nematode grazers: Effects on nutrient cycling and plant growth. *Ecological Monographs* 55, 119-140
- Neher, D.A. and Powers, T.O. 2004. Nematodes. In: Hillel, D., Rosenzweig, C., Powlson, D., Scow, K., Singer, M. and Sparks, D. (editors) *Encyclopedia of Soils in the Environment*, Vol. 3, pp. 1-5, Academic Press, New York.
- Xiao, H., Griffiths, B., Chen, X., Liu, M., Jiao, J., Hu, F. and Li, H. 2010. Influence of bacterial-feeding nematodes on nitrification and the ammonia-oxidizing bacteria (AOB) community composition, *Applied Soil Ecology* 45, 131-137
- Hendrickx, G. (1995). An automated apparatus for extracting free-living nematode stages from soil. *Nematologica* 41, 308.

Ley management effects on N₂ fixation, crop N dynamics and residual N

Dahlin, A.S.^a, Stenberg, M.^b, Marstorp, H.^a

^aSwedish University of Agricultural Sciences, Dept. of soil and environment, Uppsala, Sweden

^bSwedish University of Agricultural Sciences, Dept. of soil and environment, Skara, Sweden

1. Background & Objectives

Biological fixation of atmospheric nitrogen (N₂) of various species of clover is an important N input into different types of cropping systems, e.g. through fodder production and green manure leys. In order to assess how efficient and environmentally friendly such systems are, it is important not only to determine the amount of fixed N₂ but also to understand how N flows and distribution of fixed N₂ in the soil/plant system are affected by management practices. The aim of this study was to: 1) quantify the effect of cutting strategies on N₂ fixation and distribution of fixed N₂ in the soil-plant system of pure clover leys and mixed clover grass leys, and 2) quantify N supply to a cereal crop.

2. Materials & Methods

We tested the effect of cutting regime (harvested, mulched, intact) on the symbiotic N₂ fixation and the distribution of the fixed N₂ in the soil/plant system in a field experiment with pure red clover and mixed red clover-perennial ryegrass green manure leys. Stands of pure perennial ryegrass were also included for reference. The experiment was carried out in south-western Sweden and repeated during three consecutive years. Symbiotic N₂ fixation in clover was determined with ¹⁵N isotope dilution technique (Dahlin and Stenberg, 2010a), below-ground N and shoot litter N was determined through labeling of clover leaves with ¹⁵N-urea (Dahlin and Stenberg, 2010a), and transfer of N from clover to grass estimated by ¹⁵N isotope dilution technique and through labeling of clover leaves with ¹⁵N-urea (Dahlin and Stenberg, 2010b). Total amount of fixed N₂ in the soil-plant system was calculated on the basis of determinations of N in the different plant and soil fractions. Uptake of N from mulch was determined using ¹⁵N labeled mulch material (Dahlin et al., 2011). Nitrogen supply to a following oat crop was determined during the year immediately following incorporation of the leys by determination of soil mineral N and N in crop grain and straw.

3. Results & Discussion

The total amount of fixed N₂ was higher in the harvested and mulched treatments (average 45.3 g N m⁻²) than in the intact treatment (mean 31.8 g N m⁻²). Recycling of N to the ley in the mulched treatment was 21% of the N in the mulch and contributed 13.7% (pure clover) and 2.2% (mixed clover-grass) of clover plant N uptake during re-growth. Uptake of N from mulch did not significantly decrease the amount of fixed N₂ in the mulched treatment compared to the harvested treatment but instead contributed to greater total biomass. This is contradictory to the findings of Heuvelink et al. (2005) who found a reduction of N₂ fixation by mulching. However, the quantity of mulch used in their study was approx. 3 times larger than in our study where the mulch corresponded to the standing biomass before cutting. Large amounts of fixed N₂ was found in the below ground fractions corresponding to 53%, 46%, and 60% of total fixed N₂ in intact, harvested and mulched treatments, respectively. In the harvested treatments most of the remaining fixed N₂ had been exported from the field with the harvested shoot. In the mulched treatment 7% of the fixed N₂ was lost, presumably via gaseous losses. Although the total N₂ fixation did not differ between the harvested and mulch treatments, it was thus a noticeable difference in where the N was located.

The estimated N transfer from the red clover to the companion ryegrass ranged 0.9 to 2.5 g N m⁻², which was within the range reported for first year leys (e.g. Høgh-Jensen and Schjørring, 2000), and corresponded to 13-26% of fixed N₂. The estimated N transfer in the mulched and

the intact treatments was larger compared to the cut treatment when the transfer via wilting leaves in intact stands and shoots left lying on the ground in the mulched stands was included in the estimates. This suggests that N transfer is not affected by cutting strategies as long as shoot biomass is not left in the field and the cutting frequency is high enough to minimize falling leaf litter. The N transfer contributed strongly to the N budget of the companion ryegrass, especially in the stands where leaf fall contributed to the transfer. The uptake of clover-derived N by a companion crop may have implications for the composition and feeding value of fodder leys as well as for the efficiency catch crops.

In late autumn, after turning under the ley, amounts of soil mineral N to 90 cm depth was significantly highest after pure clover (mean 5.6 g N m⁻²), followed by the mixed ley (27 g N m⁻²) and least after pure grass ley (14 g N m⁻²), and higher after intact leys (38 g N m⁻²) than after mulched leys (27 g N m⁻²). However, soil mineral N in spring was similar after pure clover and mixed leys and after intact and mulched stands. Nitrogen supply from the ley to the following oat crop resulted in similar and approx. 20% higher yields (corresponding to an additional 1000 kg grain ha⁻¹) in the pure clover and mixed ley treatments compared with the pure grass treatment. Nitrogen use efficiency expressed as N in oat grain and straw at harvest in relation to total fixed N₂ was on average 58% for the intact mixed ley and about 30% for the mulched leys and the intact pure clover ley. However, the differences were not significantly different. Overall, the high soil mineral N concentration in autumn after pure clover compared with mixed ley, and the subsequent risk for substantial N losses, did not convey any harvest benefit. Also, the larger amount of fixed N₂ obtained in the mulched than in the intact leys had no significant effect on the cereal yield during the first year after ley incorporation.

4. Conclusion

The results indicate that N flows are larger in mulched and harvested green manure leys than in intact leys. The amount of fixed N₂ below-ground was not affected by the cutting regime, but the below-ground N made up a larger proportion of the fixed N₂ in the intact treatments than in the cut treatments. This shows that the cutting strategy should be taken into consideration when estimating total nitrogen fixation in green manure leys. To minimize the potential negative environmental effects, we recommend that green manure leys should be harvested rather than mulched, and mixed stands including grasses should be used rather than pure legume stands.

References

- Dahlin A.S., Stenberg M. and Marstorp H. 2011. Mulch N recycling in green manure leys under Scandinavian conditions. *Nutrient Cycling in Agroecosystems* 91, 119-129.
- Dahlin A.S. and Stenberg M. 2010. Translocation of N from red clover to perennial ryegrass in mixed stands under different cutting strategies. *European Journal of Agronomy* 33, 149-156.
- Dahlin A.S. and Stenberg M. 2010. Cutting affects the amounts and allocation of symbiotically fixed N in green manure leys. *Plant and Soil* 331, 401-412.
- Heuwinkel, H., Guts, R., Schmid, X. and Halter, U. 2005. Does N-cycling impair the N₂ fixing activity of mulched legumes-grass in the Field? In Sebastia T, Helgadóttir A (eds) *Adaptation and Management of Forage Legumes-Strategies for Improved reliability in mixed sward*. Proceedings of the 1st COST 852 Workshop, Ystad, Sweden 20-23 Sept. 2004, pp. 141-144.
- Høgh-Jensen, H. and Schjørring, J.K., 2000. Below-ground nitrogen transfer between different grassland species: direct quantification by ¹⁵N leaf feeding compared with indirect dilution of soil ¹⁵N. *Plant and Soil* 227, 171-183.

Long-term effect of a nitrification inhibitor on N₂O fluxes from a loamy soil

Ruser, R.^a, Pfab, H.^a, Schulz, R.^a, Palmer, I.^b, Fiedler, S.^b, Buegger, F.^c, Müller, T.^a

^aInstitute of Crop Science, Fertilisation and Soil Matter Dynamics (340i), Universität Hohenheim, Stuttgart, Germany

^bInstitute of Soil Science and Land Evaluation (310), Universität Hohenheim, Stuttgart, Germany

^cInstitute of Soil Ecology, Helmholtz Zentrum München, German Research Center for Environmental Health, Neuherberg, Germany

1. Background & Objectives

Nitrification inhibitors (NIs) originally were introduced in agriculture to reduce nitrate leaching after fertilizer application. All commercial available NIs inhibit the enzymatic transformation of ammonium to hydroxylamine and thus delay nitrate production from NH₄⁺-N. Kaiser and Ruser (2000) reported that about 50% of the annual N₂O emission from German study sites occurred in winter during freezing/thawing cycles. Therefore, annual data sets are a prerequisite for a reliable evaluation of the atmospheric impact of management measures. Akiyama et al. (2010) summarized available data on N₂O fluxes after NI application. Among the 85 data sets evaluated, there were only 12 annual data sets from which 11 sets were measured under conditions without distinctive freeze/thaw changes. To our knowledge, there are currently no annual N₂O data sets for 3,4-dimethylepyrazole phosphate (DMPP) which is the most common NI in German agricultural practice. The aim of the study was to test the effect DMPP on the annual N₂O mitigation potential.

2. Materials & Methods

The study was conducted over two experimental years at a research farm of the University of Hohenheim, south of Stuttgart. The long-term rainfall at the study site is 686 mm a⁻¹ and the mean air temperature 8.8°C. A complete randomised block experiment with four replicates was established on a loamy Haplic Luvisol derived from loess. In each of the two years, lettuce was planted followed by cauliflower. Before the beginning of the experiment green rye was grown as a catch crop. All treatments received the same amount of N-fertiliser (150 and 286 kg mineral N ha⁻¹ for lettuce and cauliflower, respectively) as ammonium nitrate sulphate (ASN). As NI we tested 3,4-dimethylepyrazole phosphate (DMPP). The NI is granulated with ASN commercially available as "ENTECC 26[®]". The fertiliser in the conventional 'control' treatment (-NI) and in the treatment with NI (+NI) was applied broadcast. Trace gas flux rates were measured, at least once a week, using the closed chamber method. Chamber design and calculation of the N₂O and CO₂ flux rates with a linear regression approach are described in detail by Flessa et al. (1995). Simultaneously to the trace gas sampling soil samples were taken from the A_p-horizon and analysed for soil moisture and mineral N.

3. Results & Discussion

The cumulative N₂O emissions varied between 2.8 kg N₂O-N (+NI, second year) and 8.8 kg N₂O-N ha⁻¹ a⁻¹ (-NI, first year) (Table 1). The emissions in the first year were nearly twice as high as in the second year. The reason for the higher emissions in the first year might be the incorporation of green rye immediately before planting and fertilisation. The turn-over of this material led to an additional O₂ consumption favouring denitrification. As a result, the highest N₂O flux rates of the whole experiment occurred in this period (not shown). No catch crop was sown in autumn of the first year. In accordance with the literature summarised by Akiyama et al. (2010) the addition of the NI strongly reduced N₂O emissions during the cropping season. Despite big differences between the two experimental years the NI reduced the annual N₂O emissions as compared to the -NI treatment by at least 40%. As mentioned by Akiyama et al. (2010) the lower N₂O emissions after NI

application were a result of lower nitrification rates (and thus lower N₂O production from nitrification) and of the lower substrate availability (NO₃⁻) for denitrification.

Table 1. Mean cumulative N₂O emission (n=4) from the treatment without NI (-NI) and with NI (+NI) in the two years.

		-NI	+NI
		----- kg N ₂ O-N ha ⁻¹ -----	
1 st year	Cropping season	4.7 ^b	2.7 ^a
	Winter season	4.1 ^b	2.0 ^a
	Annual	8.8 ^b	4.7 ^a
2 nd year	Cropping season	2.5 ^A	1.7 ^A
	Winter season	2.2 ^A	1.1 ^A
	Annual	4.7 ^B	2.8 ^A

Statistically significant differences within every experimental year are indicated by different letters (Student-Newman-Keuls test, p<0.05).

Surprisingly, the N₂O emissions in the +NI treatment were also lower in the winter season. The period of distinctive lower N₂O fluxes during the winter season was more than 15 weeks after the addition of the NI. At this time the active component of DMPP must have been degraded. As reported by Zerulla et al. (2001) DMPP is decomposed within approximately six weeks (at 20°C). In the period of lower N₂O fluxes from the +NI treatment in winter there were no significant differences between the mineral N contents of the soil, neither in the NH₄⁺- nor in the NO₃⁻-fraction. Therefore, the reason for this phenomenon remains speculative. However, as compared to the -NI treatment, a lower microbial CO₂ release in the +NI treatment indicates a reduced heterotrophic activity or probably a reduction of the heterotrophic microbial biomass. Incubation studies also showed, at least on the short-term, a decreased CO₂ release after the addition of DMPP (Kapoor, unpublished data). Weiske et al. (2001) also reported a reduction of the CO₂ flux rates after the addition of DMPP. Without reference to the reason for the lower CO₂ fluxes, it seems that the reduction of the N₂O emission in the winter period was a result of a decreased N₂O production during denitrification since nitrification is CO₂ autotrophic.

4. Conclusion

This study highlights that the addition of NIs to an NH₄⁺ rich fertiliser has a high potential to reduce N₂O emission from agricultural soils. We proofed this potential for DMPP on an annual basis. However, further investigations on the observed effect of the NI in the winter period are necessary.

References

- Akiyama, H., Yan, X. and Yagi, K. 2010. Evaluation of effectiveness of enhanced-efficiency fertilizers as mitigation options for N₂O and NO emissions from agricultural soils: Meta-analysis. *Global Change Biology* 16, 1837-1846.
- Flessa, H., Dörsch, P., Beese, F. 1995. Seasonal variation of N₂O and CH₄ fluxes in differently managed arable soils in southern Germany. *Journal of Geophysical Research* 100, 115-124.
- Kaiser, E. A. and Ruser, R., 2000. Nitrous oxide emissions from arable soils in Germany - An evaluation of six long-term field experiments. *Journal of Plant Nutrition and Soil Science* 163, 249-260.
- Weiske, A., Benckiser, G. and Ottow, J.C.G. 2001. Effect of the new nitrification inhibitor DMPP in comparison to DCD on nitrous oxide (N₂O) emissions and methane (CH₄) oxidation during 3 years of repeated applications in field experiments. *Nutrient Cycling in Agroecosystems* 60, 57-64.
- Zerulla, W., Barth, T., Dressel, J., Erhardt, K., Horchler von Locquenghien, K., Pasda, G., Rädle, M. and Wissemeier, A. 2001. 3,4-Dimethylpyrazole phosphate (DMPP) - A new nitrification inhibitor for agriculture and horticulture. An introduction. *Biology and Fertility of Soils* 34, 79-84.

Maize stover incorporation increased N₂O emissions twofold during a barley crop

Ábalos, D.¹, Sanz-Cobeña, A.¹, Sánchez-Martín, L.¹, Téllez, A.¹, García-Marco, S.¹, Vallejo, A.¹

¹ ETSI Agrónomos, Technical University of Madrid, Ciudad Universitaria, 28040 Madrid, Spain

1. Background & Objectives

Agricultural soils in semiarid Mediterranean areas are characterized by low organic matter contents, featuring small fertility levels (García-Gil et al., 2000). Application of crop residues and/or manures as amendments is a cost-effective and sustainable alternative to overcome this problem. However, these management practices may induce important changes in the N₂O emissions from these agroecosystems (Huang et al., 2004; Vallejo et al., 2006). The objective of this study was to evaluate the effect of applying maize residues and fertilizer inputs (organic and/or mineral), combined or alone, on the N₂O emissions under field conditions.

2. Materials & Methods

A set of plots was established in a field site which had been sown with barley. The experimental design was a randomized complete block design with three blocks and two factors: crop residue management practices (remove (-R) or retain (+R)), and fertilizer type (control without N-fertilizer application (C), pig slurry + urea (PS+U), and urea (U)). Before sowing (November) 50 kg N ha⁻¹ were applied as urea or pig slurry depending on the treatment. The remaining 100 kg N ha⁻¹ were applied as urea for all fertilized treatments, as a top-dressing (March). Gaseous emissions were measured using the chamber technique (Roelle et al., 1999). Denitrification capacity was measured according to the technique described by Yeomans et al. (1992) but without added C in order to evaluate if the C of crop residues and/or the organic fertilizer had a significant effect over the N₂O emissions. Dissolved Organic Carbon (DOC) was determined as described by Mulvaney et al. (1997). Soil NO₃⁻ and NH₄⁺ were colorimetrically analyzed. Differences between treatments in the cumulative emissions were analysed using analysis of variance (ANOVA, *P* < 0.05).

3. Results & Discussion

The incorporation of maize straw significantly increased the N₂O emissions during the experimental period by c. 105%. This effect was more pronounced after the top-dressing fertilization. Then, the emissions from the U and PS+U plots amended with crop residues were 138 and 90% higher, respectively, than that for the same fertilizer treatments without residue incorporation. These higher emissions were most likely due to a higher denitrification capacity stimulated by the C substrate added with the maize straw (Figure 1). The partial substitution of urea by pig slurry was a mitigation strategy to reduce N₂O emissions, under the specific soil conditions in which the experiments were carried out. The most likely mechanism by which pig slurry reduced N₂O emissions was by significantly reducing the N₂O/N₂ ratio (Dittert et al. 2005).

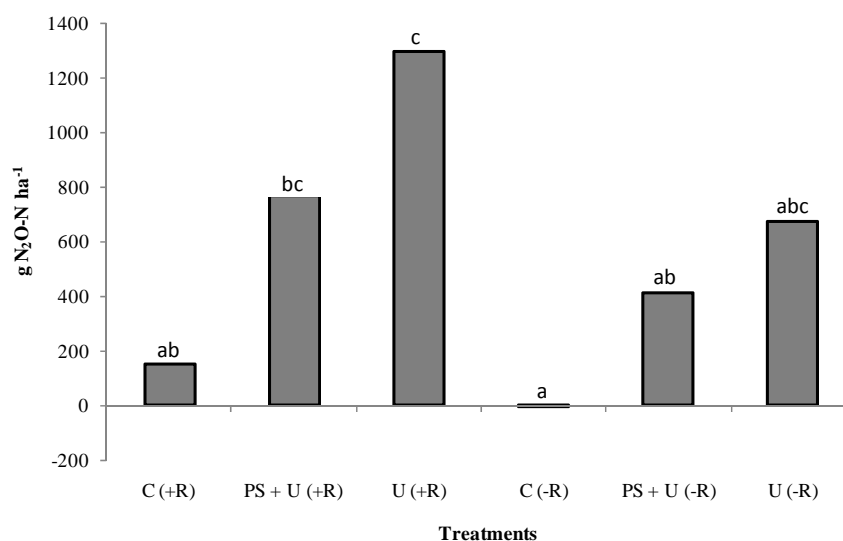

Figure 1. Cumulative emissions of N₂O-N during the crop period.

4. Conclusion

This study underlines the key role of C added with maize stover residues in the emissions of N₂O from soils with a low organic C content under rainfed conditions. The incorporation of crop residues increased the N₂O emissions. Based in our results, its addition can't be regarded as an improved management practice. In this type of soils pig slurry should be recommended instead of urea.

References

- Dittert, K., Lampe, C., Gasche, R., Butterbach-Bahl, K., Wachendorf, M., Papen, H., Sattelmacher, B. and Taube, F. 2005. Short-term effects of single or combined application of mineral N fertilizer and cattle slurry on the fluxes of radiatively active trace gases from grassland soil. *Soil Biology and Biochemistry* 37, 1665-1674.
- Garcia-Gil, J.C., Plaza, C., Soler-Rovira, P. and Polo, A. 2000. Long-term effects of municipal solid waste compost application on soil enzyme activities and microbial biomass. *Soil Biology & Biochemistry* 32, 1907-1913.
- Huang, Y., Zou, J., Zheng, X., Wang, Y. and Xu, X. 2004. Nitrous oxide emissions as influenced by amendment of plant residues with different C:N ratios. *Soil Biology & Biochemistry* 36, 973-981.
- Mulvaney, R.L., Khan, S.A. and Mulvaney, C.S. 1997. Nitrogen fertilizers promote denitrification. *Biology and Fertility of Soils* 24, 211-220.
- Roelle, P., Aneja, V. P., O'Connor, J., Robarge, W., Kim, D. and Levine, J. S. 1999. Measurement of nitrogen oxide emissions from an agricultural soil with a dynamic chamber system. *Journal of Geophysical Research* 104, 1609-1619.
- Vallejo, A., Skiba, U., Garcia-Torres, L., Arce, A., Lopez-Fernandez, S. and Sanchez-Martin, L. 2006. Nitrogen oxides emission from soils bearing a potato crop as influenced by fertilization with treated pig slurries and composts. *Soil Biology and Biochemistry* 38, 2782-2793.
- Yeomans, J.C., Bremner, J.M. and McCarty, G.W. 1992. Denitrification capacity and denitrification potential of subsurface soils. *Communications in Soil Science and Plant Analysis* 23, 919-927.

Malting industry effluents as a source of nitrogen to soils

Campana H.^a, Cordovil C.^b, Benedetti P.^a, Uribe Etchevarría M.^a, Airasca A.^a, de Varennes A.^b

^aGEIA – Grupo de Estudio de Ingeniería Ambiental – Facultad Regional Bahía Blanca- Universidad Tecnológica Nacional – 11 de Abril 461 – 8000 Bahía Blanca - Argentina

^bBiosystems Engineering Centre, Instituto Superior de Agronomia, TU Lisbon, Tapada da Ajuda, 1349-017, Lisbon, Portugal

1. Background & Objectives

The amount of mineral nitrogen (N) applied to soil should be reduced whenever organic sources of the nutrient are available. A large number of studies have addressed the value of several sludges as sources of N, in particular sewage and pig sludges (Chantigny et al., 2004; Mora et al., 2005; Yague and Quilez, 2010; Antil et al., 2011). The malt industry generates effluents which could be applied to soil as organic amendment, but the amount of N that can be supplied from these sludges has not been investigated before. The objective of this paper is to provide preliminary information on the N fertiliser value of two types of sludges from a malt industry.

2. Materials & Methods

In this experiment, two types of sludges were applied to a Mollisol from Cabildo, in the Province of Buenos Aires, Argentina. Both sludges came from the same barley malting plant, the first was an aerobic sludge from wastewater treatment that used an activated sludge process (A), and the second was the same sludge treated by a subsequent anaerobic digestion (AN). Soil without any amendment (C) and soil receiving the same amount of N as urea (U) were used as controls. Nitrogen added was equivalent to 120 kg N ha⁻¹ (0.32 g N for each pot amended or fertilized). The amount of soil used was approximately 2600 g per pot. The soils were incubated at room temperature and water added regularly to keep a constant moisture content. The effects on soil pH, electric conductivity (EC), and nitrate-N and ammonium-N were measured one week, and one and three months after amendment application.

3. Results & Discussion

The application of urea led to the lowest pH both after one and three months of incubation, while the AN treatment had the greater initial pH (Figure 1). The decrease in pH derived from a rapid nitrification of N in urea, as discussed later. Three months after the beginning of the incubation no differences between unamended soil and that receiving both types of sludges were apparent. The EC increased due to the application of both organic amendments at the beginning of the experiment and after one month, but became similar in all treatments after three months of incubation, except for control unamended soil (Figure 1). Mineral N (both nitrate and ammonium) was greatest when urea was applied by comparison with the organic amendments. The amount of mineral N following urea application became the same as in all other three treatments after three months of incubation, suggesting that this was lost or converted into organic forms by soil microorganisms. The organic amendments did not lead to greater levels of mineral N suggesting that they act as slow release N fertilisers and may contribute to the pool of organic N in soils.

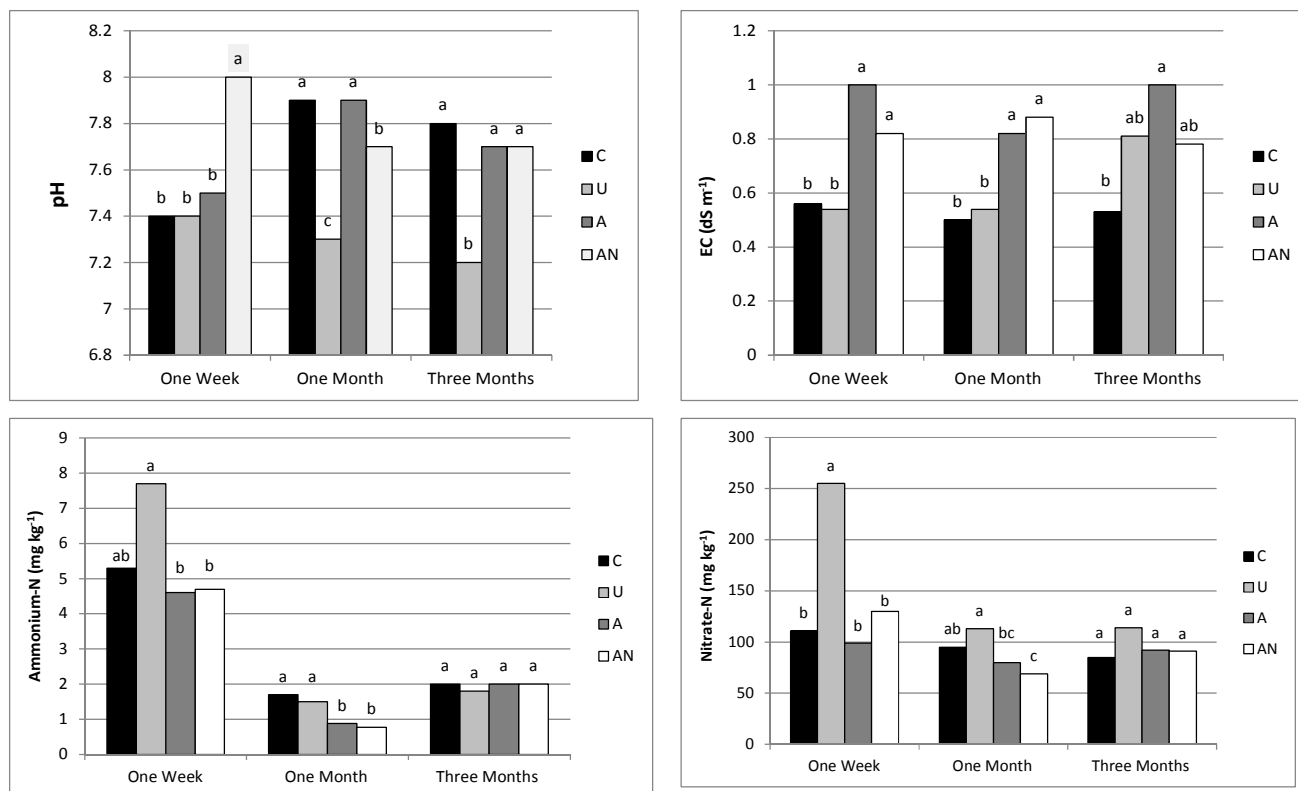

Figure 1. Values of pH, electric conductivity (EC), ammonium-N and nitrate-N during the incubation of a Mollisol with urea (U), aerobically digested sludge (A), aerobically digested sludge followed by an anaerobic digestion (AN) and control soil with any amendment (C).

4. Conclusion

Both sludges from the malting industry can be used as slow release sources of N when applied to soils. Further studies are required to investigate their effects on plant growth.

References

- Antil, R.S., Bar-Tal, A., Fine, P. and Hadas, A. 2001 Predicting nitrogen and carbon mineralization of composted manure and sewage sludge in soil, *Compost Science & Utilization* 19, 33-43.
- Chantigny, M.H., Angers, D.A., Morran, T. and Pomar, C. 2004 Dynamics of pig slurry nitrogen in soil and plants as determined with ¹⁵N, *Soil Science Society of America Journal* 68, 637-643.
- Mora, R., Paredes, C., Perez-Murcia, M.D., Perez-Espinosa, A. and Moreno-Caselles, J. 2005 Nitrogen dynamics in a calcic petrocalcic soil from the SE Spain treated with an anaerobic sewage sludge compost, *Advances in Geoecology* 36, 589-594.
- Yague, M.R. and Quilez, D. 2010 Response of maize yield, nitrate leaching, and soil nitrogen to pig slurry combined with mineral nitrogen, *Journal of Environmental Quality* 39, 686-696.

Managing nitrogen losses in shallow glacial aquifers: denitrifying bioreactors as a potential mitigation measure

Ibrahim, T.G.^a, Fenton O.^a, Lanigan, G.J.^a, Richards, K.G.^a, Healy M.G.^b

^aTeagasc Environment Research Centre, Johnstown Castle, Co. Wexford, Ireland

^bCivil Engineering, National University of Ireland, Galway, Co. Galway, Ireland

1. Background & Objectives

Denitrifying bioreactors enhance the microbiologically-mediated reduction of nitrate (NO_3^-) in water using an organic carbon (orgC) rich media, to treat diffuse and point-sources of nitrogen (N). They achieve high NO_3^- removal, have a long life-time, and are easier to manage and less-costly than larger bioremediation designs (Schipper et al., 2010). Healy et al. (2012) showed that such bioreactors also produce substantial amounts of greenhouse gases (GHG) and dissolved contaminants (“pollution swapping”, Figure 1c), with such losses mainly originating from the media in the initial operation period. The widespread installation of bioreactors at large scale in Irish farms will require the development of design criteria that allows for 1) high denitrification rates and 2) reduced ancillary pollution. The objectives of the study are to integrate gaseous and solute flux patterns in a field-scale bioreactor filled with woodchip and sand to reproduce transit times occurring in shallow drift aquifers. This paper focuses on the design of the experiment and describes the initial monitoring results.

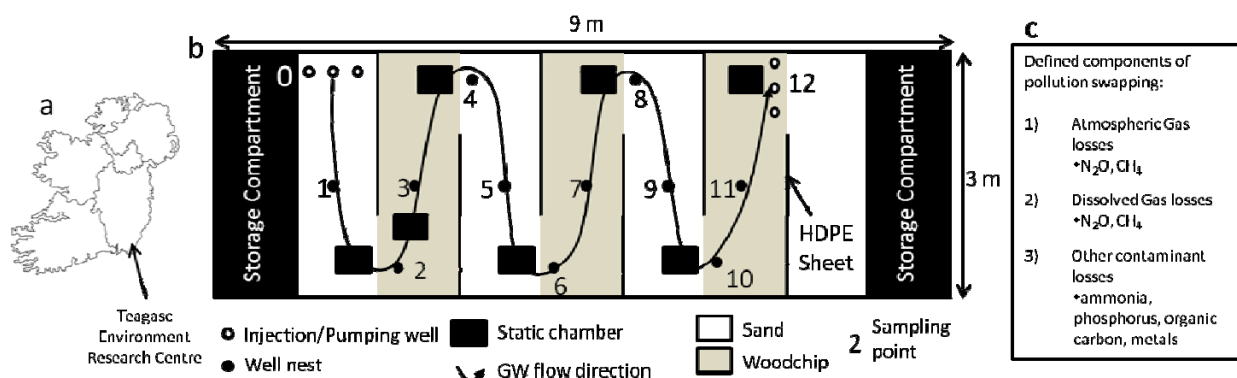

Figure 1. a. Map of the area. b. Top view schematic of the bioreactor. c. Pollution swapping components

2. Materials & Methods

A reinforced plastic tank with water storage compartments and a base layer of gley soil was installed at the Teagasc Environment Research Centre, Co. Wexford, Ireland (Figure 1). The open section was divided in seven cells using plastic sheets pushed into the gley and leaving a 1 m width aperture on alternate sides of the tank. The woodchip was spread on a concrete surface and washed to reduce initial contaminant levels. Over two periods of nine days (Figure 2), it was regularly sprayed with pumped groundwater for circa one hour (“washing period”). Sprayed and leaching water were analysed for dissolved organic carbon (DOC), ammonium ($\text{NH}_4\text{-N}$), dissolved reactive phosphorus (DRP) and chloride (Cl^-). Next, the tank cells were alternatively filled with sand and washed woodchip (1 m thick). A set of injection/pumping wells and peristaltic pumps allowed for groundwater to circulate within the media (Figure 1). Within each cell, nests of wells (one well and one multi-level sampler with 3 depths of sampling) allowed for assessing changes in water table depth and groundwater hydrochemistry. Physiochemical parameters quantified included Cl^- , NO_3^- , $\text{NH}_4\text{-N}$, and Dinitrogen/Argon (N_2/Ar) ratios. Gaseous emission fluxes to the atmosphere were monitored using static chambers installed on top of the media.

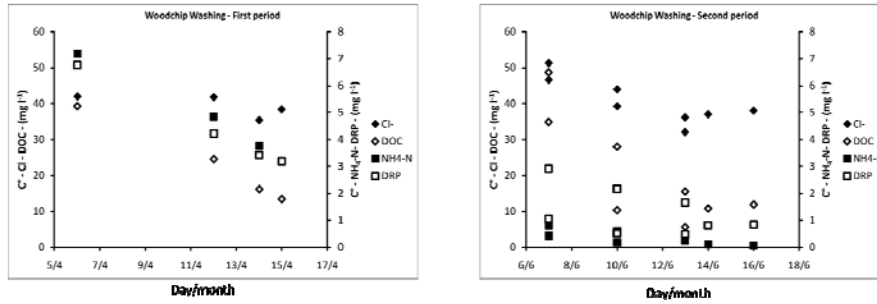

Figure 2. Changes in solute concentrations in leaching water out of the woodchip for the two washing periods

3. Results & Discussion

Ammonium and DRP concentrations in leaching water strongly decreased during initial washes (7.19 to 0.06 mg L⁻¹ and 6.77 to 0.84 mg L⁻¹, respectively, Figure 2). Although DOC concentrations decreased during a washing event, they increased again between washes. After woodchip was installed in the bioreactor, high NO₃⁻ removal was achieved in the second cell of the tank (2.66 mg L⁻¹ down to detection limits, Figure 3a). This removal was related to an increase in N₂/Ar ratios at shallow and medium depth (10 and 40 cm, Figure 3b) indicating that complete denitrification occurred. Later variations in N₂/Ar ratios could relate to degassing linked to the production of other gases in strongly reducing conditions (e.g. methane, data not shown). Ammonium concentrations strongly increased between the inlet and outlet of the tank (0.01 to 1.73 mg L⁻¹, respectively, Figure 3c). Processes such as dissimilatory NO₃⁻ reduction to NH₄⁺ (DNRA) may in part explain this pattern. Nevertheless, the strong increase in NH₄-N in the deeper layers (70 cm in Figure 3c, up to 29.49 mg L⁻¹ at nest 7) may indicate leaching from the gley soil or mineralisation of organic N.

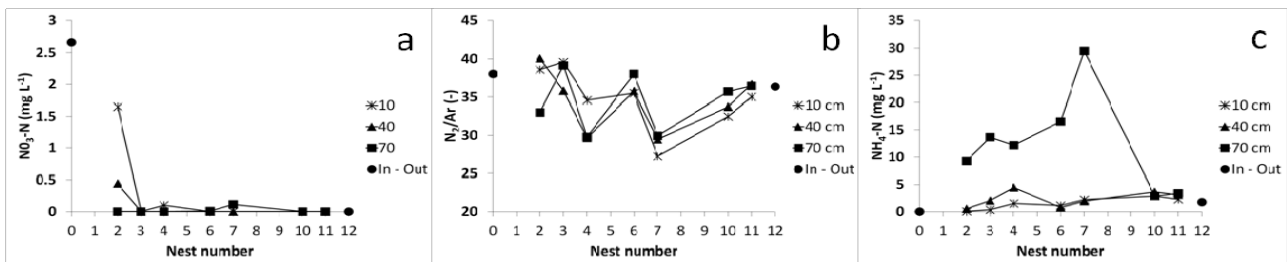

Figure 3. Longitudinal and depth profiles (10, 40 and 70 cm below media top surface) of NO₃-N, N₂/Ar and NH₄-N ratios in the bioreactor. See Figure 1 for nest numbers

4. Conclusion

Pre-washing of woodchip proves to be efficient to reduce initial contaminant losses, except for DOC. Assessing the coupling between gas and solute patterns at high spatial resolution within a bioreactor will allow for improved design criteria based on 1) identifying optimal transit times for high denitrification and low pollution swapping and 2) developing additional mitigation sequences to further limit losses of dissolved contaminants and GHGs from such bioreactors.

References

Healy, M.G., Ibrahim, T.G., Lanigan, G., Serrenho, A. and Fenton, O. 2012. Effect of different carbon media on nitrate removal efficiency and pollution swapping in laboratory denitrifying bioreactors. *Ecological Engineering* 40, 198-209
 Schipper, L.A., Robertson, W.D., Gold, A.J., Jaynes, D.B. and Cameron, S.C. 2010. Denitrifying bioreactors-An approach for reducing nitrate loads to receiving waters. *Ecological Engineering* 36, 11, 1532-1543

Methodology for the selection of the geographic location of new experimental sites and treatments to generate new N₂O emission factors and data for model validation in the UK: the prioritisation phase of the *InveN₂Ory* project.

Chadwick, D.^a, Olave, R.^b, Laughlin, R.^b, Cardenas, L.^a, Williams, J.^c, Skiba, U.^d, Rees, B.^e, Buckingham, S.^e, Topp, Ke and Anthony, S.^c

^aNorth Wyke (Rothamsted Research), ^bAFBI Hillsborough, ^cADAS UK Ltd., ^dCEH Edinburgh and ^eSAC

1. Background & Objectives

The UK Government has challenging national commitments for the mitigation of greenhouse gas emissions. In order to improve the emissions estimates and increase the ability of the Agricultural GHG inventory to better reflect the country's soils, climate, nitrogen (N) management of the range of farming systems, livestock breeds and diets, and take account of explicit mitigation strategies, the UK has funded a 5-year programme of research which in essence, will support the transition from a Tier 1 IPCC methodology for reporting, to a Tier 2 approach. The nitrous oxide (N₂O) component of this programme is being co-ordinated via the *InveN₂Ory* project, through a number of linked activities. The first of these being a prioritisation phase in which standard joint experimental protocols have been generated (to ensure new N₂O fluxes are measured using the same approaches by the multiple research groups across the nine new experimental platforms), and the location of the new experimental sites has been confirmed. In this paper we describe the approach taken to determine where the geographical locations for these sites should be, and which experimental treatments should be included.

The project team made an initial 'gap analysis' prior to the proposal submission, of what additional N₂O emission factors (EFs) from soils would be required to compliment the number of existing and already planned experiments under other government funded projects that will deliver IPCC compliant N₂O EFs under UK conditions. In this paper we summarise the more complete 'gap analysis' that was carried out to confirm the selection of experimental platforms and treatments to compliment project modelling and the database of existing and planned EF data from current projects, in order to improve the N₂O inventory from Tier 1 to Tier 2.

2. Materials & Methods

A geographical assessment was made of the land area (ha) under the range of key soil texture-rainfall zone combinations for grassland and arable land in the UK. The sensitivity of the N₂O EF to these combinations of soil texture and rainfall was assessed following typical N management on arable and grassland soils using the DNDC94 model (see Figure 1), and scaled indicative N₂O EFs from soils were generated for these soil-rainfall-N management combinations. This generated information to establish the relative importance of the individual soil texture-rainfall zones to the total UK indicative N₂O emission.

Additional information used in this assessment was provided by a collation of UK N₂O EF from existing and planned experiments in current projects. Not all of these EF measurements could be used, as some were not IPCC compliant, i.e. were not of 12-month duration or did not include a non-amended control. These were our primary filters for removing experimental measurements and deriving a list of IPCC compliant EFs for the key N sources applied to agricultural soils (for grass and arable land). These current and planned N₂O EFs were then 'mapped' onto the spatially explicit scaled indicative N₂O emissions to generate an index of the number of EF measurements per unit of emission.

3. Results & Discussion

The results of the sensitivity modelling (with DNDC) of N inputs on grassland to soil texture and rainfall are shown in figure 1.

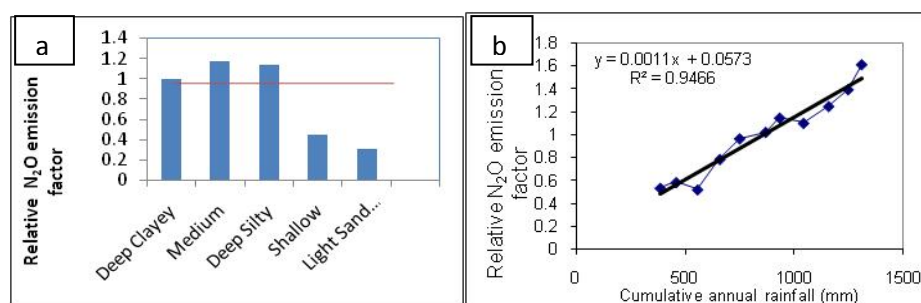

Figure 1. Sensitivity of N₂O emissions to soil texture (a), and rainfall (b), on grassland (modelled using DNDC94).

The modelling demonstrates a clear effect of soil texture and rainfall on relative N₂O emissions. Hence, due consideration is required of the soil texture–rainfall zone combination when assessing the currently available emission factors from different N sources, and the ‘gap filling’ required by additional experimental measurements.

4. Conclusions

As a result of this process, *i.e.* having taken account of a) the land area under different soil texture–rainfall zones, b) the sensitivity of N₂O soil EFs to soil texture and rainfall (via the DNDC modelling), and c) an improved stock-take of existing and planned experiments which will deliver IPCC compliant EFs, we were able to confirm the geographical locations of the proposed sites across England, Northern Ireland, Scotland and Wales.

The choice of N source (urine, dung, livestock manure and fertiliser) to apply at these nine experimental sites needed to reflect the major sources of N₂O identified by the current UK N₂O inventory, and be representative of the geo-climatic zones. The experimental treatments at each experimental site were chosen to:

- generate new (gap filling) EFs for the typical range of N sources (fertiliser N type, manure type, urine and dung)
- provide additional 12-month N₂O flux data sets for a range of soil/climate/N management combinations for model validation and assist future model interpolation
- provide an understanding of the relationship between N application rates and N₂O EFs
- determine the effect of N application timings on the N₂O EF
- explore mitigation methods which could be included in the new inventory structure (e.g. split doses of mineral N fertiliser and use of nitrification inhibitors)
- generate EFs that future proof the improved inventory for potential ammonia emission mitigation, e.g. use of low trajectory slurry application techniques.

Model estimation of nitrogen leaching under derogation measures on organic nitrogen fertilization in Lombardia (northern Italy)

Perego, A.^a, Bernardoni, E.^b, Carozzi, M.^a, Giussani, A.^a, Brenna, S.^b, Acutis, M.^a

^aDepartment of Plant Production, University of Milan, Italy

^bLombardia Regional Agency for Agriculture and Forestry, Italy

1. Background & Objectives

The derogation approved by the European Commission for the Italian Nitrate Vulnerable Zones (NVZ) located in the Po plain contains, among others, two main measures related to N management: (i) the autumn distribution of manure should be reduced, in order to minimize nitrogen losses, (ii) derogation farms will be required to improve manure management adopting long growing season and high nitrogen uptake cropping systems, including in particular winter and summer herbage, after maize and winter cereal harvest, respectively. The objective of this paper was to evaluate nitrate leaching under 3 alternative scenarios of cropping systems by applying ARMOSA simulation model (Acutis et al., 2007) in the entire plain area of Lombardia region. One of the studied scenarios was defined according to the outline of the derogation decision.

2. Materials & Methods

The ARMOSA model ran over 20 years (1988-2007) in 35 simulation units, obtained by dividing Lombardia plain in homogenous districts in terms of pedological, climatic and cropping systems features located in both Nitrate Vulnerable Zones (NVZs, 22 districts) and non-Nitrate Vulnerable Zones (nNVZs, 13 districts). Each district was characterized by (i) two representative soil types, (ii) a 20 years meteorological data set, (iii) crop rotations according to the regional land use analysis, (iv) organic N load, calculated on the basis of livestock density. Three scenarios have been then defined for districts laying in NVZs: (i) an hypothetical scenario with no limitation in organic N application (1), (ii) a scenario compliant with the mandatory threshold of 170 kg organic N ha⁻¹y⁻¹ (2) provided by the Nitrate Directive (676/91/CE), (iii) a scenario in which N organic threshold was enhanced to 250 kg N ha⁻¹y⁻¹ (3) according to the Italian derogation outline. Under 1 scenario organic-N supply was defined on the basis of district load and mineral-N was 100 to 180 kg N ha⁻¹y⁻¹ according to the crops need. In 2 organic-N was 170 and mineral-N up to 180 kg N ha⁻¹y⁻¹. Under 1 and 2 scenarios, both autumn and spring application of organic-N were simulated. In 3 organic-N was limited to a maximum of 250 kg N ha⁻¹y⁻¹, which was applied only in spring, and mineral N input was up to 100 kg N ha⁻¹y⁻¹. The 5-years rotations were: A (monoculture of FAO 600 maize), B (permanent grass), C (alfalfa -grain maize-winter wheat), D (grain maize-winter wheat), E (grain maize-grass), F (alfalfa-winter wheat), G (alfalfa-winter wheat), H (FAO 500 maize-Italian ryegrass as autumn sown crop), L (grain maize-winter wheat-foxtail millet as summer herbage). The two latter rotations were simulated only under 3 scenario, being defined according to the derogation outline. The model was calibrated for both maize silage and grain crops, Italian ryegrass and winter wheat in monitoring sites (Lombardia plain), whose description is given by Perego et al. (2011).

3. Results & Discussion

Mean N leaching amount were 37, 22 and 14 kg N ha⁻¹y⁻¹ under 1, 2 and 3, respectively. ANOVA test confirmed the statistically significance of scenario factor in determining N leaching (p<0.0001). Games-Howell post-hoc test has confirmed that each scenario differed statistically to others (1 vs 2 p<0.0001, 1 vs 3 p<0.0001, 2 vs 3 p=0.035). On average, N leaching decreased by 27% from 1 to 2, and by 59% from 1 to 3. B (permanent grass) and F (alfalfa-maize-wheat) rotations resulted to be

the best rotations in every scenario, while A rotation (monoculture of maize) the one associated to the highest leaching losses. D, E, G, H and L rotations had the second best score in every scenario (Table 1). The replacement of mineral N fertilizer with manure-N led to similar total N surface balance in maize-based forage systems, when manure N input was limited to 250 kg N ha⁻¹y⁻¹ threshold (Table 2). Moreover, management proposed in 3 scenario, could help in enhancing the soil organic matter and the efficiency of farmyard manure use. ARMOSA results show that winter wheat followed by summer herbage allowed for high N uptakes. Temporary grassland and alfalfa were able to assure reduced N losses via leaching.

Table 1. Mean annual N leaching (kg N ha⁻¹y⁻¹) for each simulated combination of rotation vs scenario. Values followed by different letter within a row are significantly different (P<0.05) according to Games-Howell's test.

Scenarios	rotations	Mean of annual N leaching							
		A	B	D	E	F	G	H	L
1		74c	11a	20a	40b	11a	37b		
2		43c	4a	29b	20b	6a	14ab		
3		32c	5a	16b	24bc	4a	19bc	16b	23bc
1 (nNVZ)		74c	2a	32b			22ab		

Table 2. Nitrogen balance in each scenario.

% of N input						
Mean N input (kg N ha ⁻¹ y ⁻¹)	N-uptake	N-leaching	N-volatilization	N-denitrification	N-immobilization	
1	354	60	12	3	1	24
2	289	70	9	4	2	15
3	298	70	6	3	2	18

4. Conclusions

The ARMOSA simulation results indicated that the 3 scenario appeared a good solution to face the current concern of N leaching in Lombardia plain, in fully agreement with derogation outline. Grain maize crops, as well as silage maize in a double-cropping systems with Italian ryegrass showed in particular an high N uptake; similarly, summer herbage after winter wheat harvest lowered nitrogen losses even in the case of organic fertilizers application at planting in summer. The increasing organic N supply and proportionally reduced mineral fertilization allowed for similar or even higher nitrogen uptake and lower leaching.

References

- Acutis M., Brenna S., Pastori M., Basile A., De Mascellis R., Bonfante A., Manna P., Perego A., Fumagalli M., Gusberty D., Velardo M.C., Trevisiol P., Sciacaluga M., Albani G., Malucelli F., Vingiani S. and Orefice, N. 2007. Modelling water and nitrogen dynamics Nitrogen in Lombardy – ARMOSA project. Regione Lombardia quaderno della ricerca n. 65, 128 pp.
- Perego A., Basile A., Bonfante A., De Mascellis R., Terribile F., Brenna S. and Acutis M. 2011. Nitrate leaching under maize cropping systems in Po Valley (Italy). *Agriculture, Ecosystems and Environment*, doi: 10.1016/j.agee.2011.06.014.

Modelling the effects of temporal overlap of urine patches on nitrogen leaching

Cichota, R.^a, Snow, V.O.^b

^aAgResearch, Grasslands Research Centre, Palmerston North, New Zealand

^bAgResearch, Lincoln Research Centre, Christchurch, New Zealand

1. Background & Objectives

In pastoral systems the uneven return of nitrogen (N) via urine is the major source for N leaching losses because the amount of N in urine patches is typically in excess of the plant's ability to take it up. The amount and timing of deposition are important factors defining the N fate in urine patches (Ledgard, 2001) and must be considered when modelling pastoral systems (Hutchings et al., 2007; Snow et al., 2009). The overlap of urine depositions is considered a potentially important issue as it can significantly alter the N load in the soil. N losses from spatial overlaps, those occurring in the same grazing day, can be quite large, but the contribution to losses over the whole paddock seems to be small, unless the stocking rate is very high (Pleasants et al., 2007). The likelihood of overlaps increases for patches deposited in subsequent grazings. We call these temporal overlaps. This is when model complexity increases rapidly and simplification is needed. The objective of this work was to investigate the extent to which temporal overlaps affect N leaching from urine patches and to test possible ways to simplify their description in modelling simulations.

2. Materials & Methods

Simulations of a ryegrass/white clover sward were constructed using the APSIM model (Keating et al., 2003) and were successfully tested against leaching experiments (e.g. Cichota et al., 2010). The simulations used here describe the overlap of two consecutive urine depositions separated by time lags varying between 1 and 240 days. These used depositions of many years and months and N amounts. Here we present data from simulations with 500 kg N ha⁻¹ depositions, the first occurring either in March (Autumn) or September (Spring). Weather and soils from two locations in New Zealand were used: Ruakura (1164 mm rain/yr) was paired with the Horotiu Silt Loam (well drained allophanic, with 95 mm of plant-available water; PAW) and the Atiamuri Sandy Loam (well drained pumice, PAW=115 mm); and Lincoln (634 mm rain/yr) paired with the Templeton Silt Loam (well drained alluvial, PAW=90 mm) and the Lismore Silt Loam (well drained stony, PAW=65 mm). The simulations were under centre-pivot irrigation and a fertiliser regime of 250 kg N ha⁻¹ yr⁻¹. Two parallel simulations were run, one with the overlap explicitly simulated and the second aggregating the two urine depositions into the time of the second deposition. N leaching was summed for three years after the first urine deposition. The difference between the two simulation runs were used to investigate the effect of aggregating urine deposition over time rather than running the two depositions explicitly.

3. Results & Discussion

The temporal overlap of urine depositions clearly increased N leaching as compared to single deposition, but the effect decreased as the time lag between depositions increased (Figure 1). Location and time of deposition were the most important factors for this variation. The deviation between simulations with explicit and aggregated urine depositions showed wide variation, and generally increased as the lag between depositions increased (Figure 2). It also showed substantially higher deviations when total leaching was low (e.g. Spring). For very short time periods (one to ten days) the error produced by aggregating the depositions was small (<10%). The deviations were still relatively small (<20%) for lags up to 90 days and therefore might be considered sufficient for

granting the simplification. Exceptions like Ruakura-Spring happened when N leaching was low. For systems with high propensity for leaching (e.g. shallow soils) the aggregation error was small because the deposited N was leached regardless how the overlap was described. For systems where the pasture had high potential to take up the deposited N, the description of urine overlaps should be explicit as the deviation increased sharply with increasing the lag between depositions. The time of urine deposition is therefore the most important factor defining whether aggregation of depositions is possible. The presence or absence of irrigation can also be important as it alters N use efficiency.

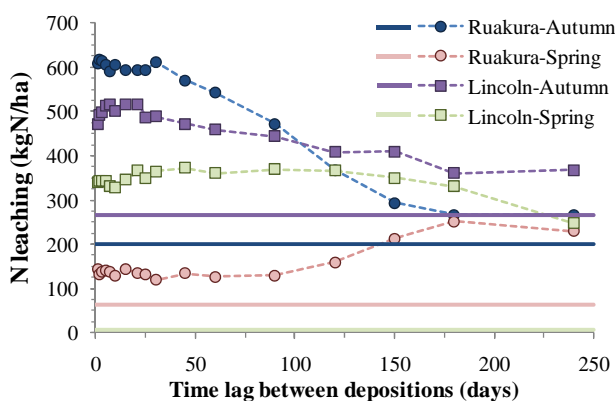

Figure 1. N leaching under overlapping urine depositions simulated in two locations and months. Data is average for all years of simulations with 500 kg N ha^{-1} depositions, with irrigation, and high fertiliser. Solid lines represent a single 500 kg N ha^{-1} urine patch.

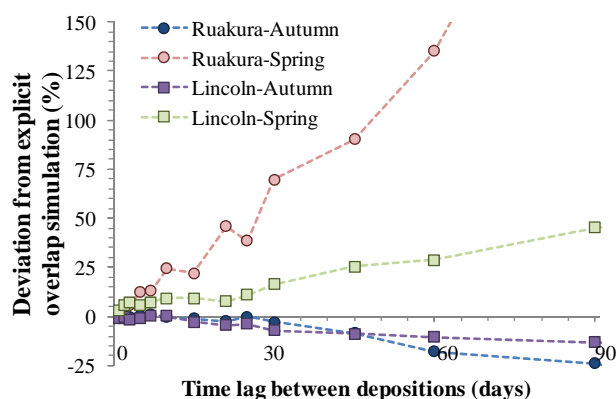

Figure 2. Deviation in N leaching simulated using explicit or aggregated urine depositions. Data is averaged for simulations at two locations and months with irrigation, high fertility, and urine depositions of 500 kg N ha^{-1}

4. Conclusion

This work highlights the importance of accounting for urine patches in grazing simulations. Overlap of urine depositions in the short-term can be aggregated into a single deposition. Aggregation can result in considerable errors for depositions in different grazings, but might be an alternative when simplification is really needed. Based on the simulations, the time of urine deposition is the most important factor defining whether aggregation can sensibly be used.

Acknowledgements

This project was funded by MSI under DairyNZ's "Dairy Systems for Environmental Protection".

References

- Cichota, R., Vogeler, I., Snow, V.O. and Shepherd, M. 2010. Describing the fate of high dose nitrogen in pastoral soils - Modelling N leaching under high N loads (urine patches). *19th World Congress of Soil Science*, Brisbane, Australia.
- Hutchings, N.J., Olesen, J.E., Petersen, B.M. and Berntsen, J. 2007. Modelling spatial heterogeneity in grazed grassland and its effects on nitrogen cycling and greenhouse gas emissions. *Agr. Ecosyst. Environ.* 121, 153-163.
- Keating, B.A., Carberry, P.S., et al. 2003. An overview of APSIM, a model designed for farming systems simulation. *Eur. J. Agron.* 18, 267-288.
- Ledgard, S.F. 2001. Nitrogen cycling in low input legume-based agriculture, with emphasis on legume/grass pastures. *Plant Soil* 228, 43-59.
- Pleasant, A.B., Shorten, P.R. and Wake, G.C. 2007. The distribution of urine deposited on a pasture from grazing animals. *J. Agric. Sci.* 145, 81-86.
- Snow, V.O., Johnson, I.R. and Parsons, A.J. 2009. The single heterogeneous paddock approach to modelling the effects of urine patches on production and leaching in grazed pastures. *Crop and Pasture Science* 60, 691-696.

N availability from pre-treated chicken and goat manure in an organic cropping system

Willekens, K.^a, Reubens, B.^a, Vandecasteele, B.^a, Beeckman, A.^b, Delanote, L.^b, De Neve, S.^c

^aInstitute for Agricultural and Fisheries Research, (ILVO), Plant Sciences Unit, Crop Husbandry and Environment, Merelbeke, Belgium

^bInagro, Department of Organic Farming, Rumbek-Beitem, Belgium

^cGhent University, Faculty of Bioscience Engineering, Department of Soil Management, Ghent, Belgium

1. Background & Objectives

Organic farmers are used to applying animal manure from different origin, and the recycling of this manure is needed to close nutrient cycle as much as possible. Improving manure product quality is another possibility to facilitate organic manure to find its way from one organic farm to another. Chicken manure is a nutrient-rich fertilizer that ought to be applied in moderate doses, which is difficult in practice. Composted chicken manure may be particularly suited for organic vegetable production. Chicken manure is less attractive for application on soils rich in available phosphorus (P) due to its low nitrogen (N)/P ratio. Combining chicken manure and a carbon-rich feedstock for co-composting or temporary storage may overcome these disadvantages and may reduce nutrient and particularly N losses during storage and after application. Goat manure from a deep litter housing system has a high carbon (C)/N ratio and its decomposition can be enhanced by mixing the stockpiled material several times. The microbial decomposition process will probably favour nutrient availability after field application. The heating in the stockpile may also counteract the survival of parasites and pathogenic bacteria. Our objective was to evaluate the fertilization value of compost and manure of different quality using a dosage as limited by the future P input standard of 55 kg ha⁻¹ year⁻¹, for vegetables.

2. Materials & Methods

A field trial with a leek crop (*Allium ampeloprasum L. var. porrum*) was set up in 2011 to assess the N availability from ten different fertilization treatments. The manure products tested were from manure pretreatments. Two chicken manure compost products (ChC1 & ChC2) were selected from two different and intensively monitored compost trials. The first trial focused on several feedstock materials, the second on the amount of chicken manure. Composting was done using a Sandberger Compost Turner® in a windrow composting system. In two other trials chicken manure was stored in a mixture with municipal waste compost (MWC). One mixture was obtained by the use of MWC in the deep litter yard of a chicken stable (ChM-MWC1), another just by artificially mixing manure and compost and storing the mixture (ChM-MWC2). Straw-rich goat manure from a deep litter housing system was mixed twice with the compost turner (TGM). The non-treated goat manure (GM) served as well as fertilization treatment. Four additional treatments were fresh chicken manure (ChM), chicken manure pellets (ChMP), grass clover mowed to use as a fertilizer (MF) and a non-fertilized control (Control). Fertilization was intended to be equal for a P input of 110 kg P₂O₅ ha⁻¹ (carrots that follow the leek in the rotation in 2012 will not be fertilized). All treatments were replicated 4 times in a completely randomized block design. N availability from the different fertilization products was assessed by determination of (1) the mineral N content in the soil profile (0-60 cm) at several sampling times, (2) the potential N mineralization on summer sampled topsoil (0-25 cm; 3 weeks' aerobic incubation under standardized circumstances) and (3) the N uptake by the crop (NO₃⁻ content in the plant juice, total N leaf content and N yield).

3. Results & Discussion

With regard to the mineral N content of the soil profile (0-60 cm), significant differences between mean values for the different fertilization treatments were found at the first intermediate sampling time, 6 weeks after planting (Table 1). For 4 out of the 10 fertilization types, marketable yield was lower than that of the control treatment, which we attribute to N-immobilization. Zanen et al. (2008) reported that compost and goat manure seemed to withdraw mineral N from soil for the digestion of the organic matter. In this field trial, a considerable amount of N was taken up from the soil. Soil N availability was quantified and this can enhance N management during the subsequent organic crop production phase (Liu et al., 2011). Marketable crop yield was significantly correlated with soil mineral N in the 0-60 cm layer ($R = 0.38$, $p < 0.05$), as well as with the total N leaf content ($R = 0.59$, $p < 0.001$) (Figure 1), both determined 6 weeks after sampling.

Table 1. Mineral N content in the 0-60 cm soil profile (Nmin 0-60cm; 2011-7-27) and marketable yield (2011-10-26), mean values for the different fertilization treatments (ANOVA, Bonferroni method, 5% significance level)

Fertilization Treatment	Nmin 0-60cm kg ha ⁻¹	Marketable Yield t ha ⁻¹	
ChC2	121	31.9	b
MF	106	33.0	ab
ChM-MWC2	130	33.2	ab
GM	130	33.7	ab
Control	119	34.2	ab
ChC1	115	34.3	ab
ChM	231	34.8	ab
TGM	141	35.1	ab
ChMP	227	36.4	a
ChM-MWC1	192	36.6	a

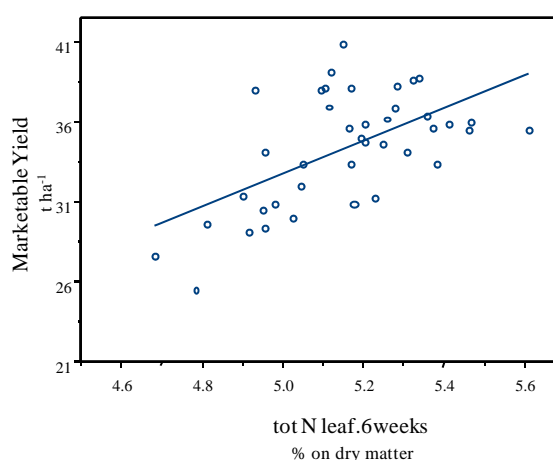

Figure 1. Linear regression between marketable yield (2011-10-26) and total N leaf content 6 weeks after planting (tot N leaf.6weeks; 2011-7-27)

4. Conclusion

Differences in N availability clearly corresponded to differences in crop performance. Absolute yield differences were relatively small for most of the fertilization treatments. The non-fertilized treatment did not show a real N shortage. Measuring the crop N status may be useful for adjustment of N availability by top mineral N dressing.

References

- Liu, K., Hammermeister, A. M., Warman, P. R., Drury, C. F. and Martin, R. C. 2011. Assessing soil nitrogen availability in contrasting cropping systems at the end of transition to organic production, *Canadian Journal of Soil Science* 91, 493-501.
- Zanen, M., Koopmans, C., Bokhorst, J. and ter Berg, C. 2008. Special Fertilisation: Successful strategies for sustainable soil management (in Dutch), Louis Bolk Institute publications, no. LD13.

N dynamics and priming effect in horticultural fields as influenced by application of mineral fertilizer N

Willekens, K.^a, Vandecasteele, B.^a, De Neve, S.^b

^aInstitute for Agricultural and Fisheries Research (ILVO), Plant Sciences Unit, Crop Husbandry and Environment, Merelbeke, Belgium

^bGhent University, Faculty of Bioscience Engineering, Department of Soil Management, Ghent, Belgium

1. Background & Objectives

The eutrophication of surface and ground water from agricultural activities is a major concern for EU policy. In this context, Flanders has to meet the objectives of the European Nitrates Directive. Overall soil condition, for example C sources, microbiology and soil structure affect N availability. C and N turnover processes may be affected by the fertilization practice. Having explored data from long-term cropping experiments, Mulvaney et al. (2009) stated that synthetic N depletes soil N. Our objective was to study the effect of applied mineral N on the N mineralization process in cultivated land with a short-term perspective. The research question was if a priming effect would take place, i.e. an enhancement of the net N release from soil organic matter after a mineral N input.

2. Materials & Methods

To study the effect of fertilizer N on the N mineralization process, a soil and crop survey was executed in 2009 on 28 fields planted with leek. The sampling was organized both in springtime (April-May), before the fertilization, and in the summer period (mid-July to mid-August), approximately 6 weeks after planting the leek crop. Each time three soil layers were sampled, i.e. 0-30cm, 30-60cm and 60-90cm and the mineral N content was extracted (1:5 w/v) in a 1 M KCl solution according to ISO 14256-2 and measured with a Foss Fiastar 5000 continuous flow analyser. The plant available N balance was calculated on the basis of a standard N uptake by the young crop of 40 kg ha⁻¹, the mineral N fertilizer input (kg ha⁻¹) and the mineral N content in the profile (kg ha⁻¹, 0-90 cm) at both sampling times. The mineral N fertilizer input comprised N from synthetic or organic fertilization, or both. This N balance result reflects the apparent net N mineralization between both sampling times (Engels and Kuhlmann, 1993). The N balance result was used, together with the mineral N fertilizer input and the total N content of the topsoil layer (% , 0-30 cm), as a variable in a linear regression model for the mineral N profile in summer. This model was set up for 2 distinct field groups, one with a high and the other with a lower level of mineral N fertilizer input. 160 kg N ha⁻¹ was the boundary level for this classification. Summer sampled topsoil (0-30cm) was aerobically incubated during 3 weeks at 15°C and 70% R.H in PVC-tubes (Ø 4.63 cm, filling height 12 cm, bulk density 1.4 g cm⁻³ and 50% WFPS), by which NH₄NO₃ (p.a. 35%N) was applied (35.8 mg kg⁻¹ dry soil) and N availability from this synthetic N input was determined.

3. Results & Discussion

In the incubation test 18 of the 28 fields showed an enhanced net mineralization rate due to the mineral NH₄NO₃ input, the so-called priming effect (Figure 1). The availability of applied mineral N was negatively correlated ($R = -0.53$, $p < 0.01$, $n = 28$) with the mineral N content in the topsoil layer. The mineral N fertilizer input on the land was positively correlated with the apparent net N mineralization balance result ($R = 0.48$, $p < 0.01$, $n = 28$), which may indicate that field application of mineral N resulted in a higher net N mineralization too. Differences in magnitude and significance level of the regression coefficient of the total N content variable in the multilinear regression models for both field groups (Table 1) did confirm the presumed enhancing effect of a mineral N input on the net N mineralization. For the group with the high level of mineral N

fertilizer input, the regression coefficient of total N content is 2.7 times higher than for the other group, although both field groups had a similar total N content. A priming effect in the incubation test was mainly found on fields with a low balance result and vice versa.

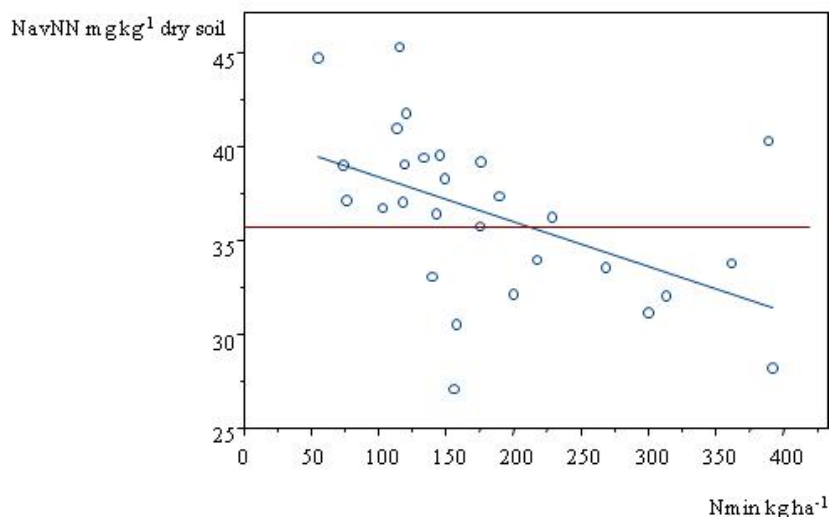

Figure 1. Linear fit regression between N availability from NH_4NO_3 (NavNN) and mineral N content in the topsoil layer (Nmin) (the red horizontal line represents the NH_4NO_3 fertilizer dose)

Table 1. Regression coefficients and mean values of the variables included in a multilinear regression model for the mineral N profile in summer, for 2 distinct field groups (high and low level of mineral N fertilizer input), ** $p < 0.01$, *** $p < 0.001$

variable	unit	LOW mineral N fertilizer input			HIGH mineral N fertilizer input		
		mean value	regression coefficient	intercept	mean value	regression coefficient	intercept
mineral N fertilizer input	kg ha^{-1}	104.9	1.48***		197.0	0.94	
total N soil content	%	0.12	372		0.12	1006**	
N balance result	kg ha^{-1}	139.5	0.99***	-57.4	244.1	0.87***	-28.8
mineral N profile	kg ha^{-1}	280.9			487.8		

4. Conclusion

A short term survey of horticultural fields revealed that mineral N input possibly enhances net N mineralization, which is a risk for N losses and soil N depletion.

References

- Engels T. and Kuhlmann H. 1993. Effect of the Rate of N-Fertilizer on Apparent Net Mineralization of N During and After Cultivation of Cereal and Sugar-Beet Crops, *Zeitschrift fur Pflanzenernahrung und Bodenkunde* 156, 149-154.
- Mulvaney R.L., Khan S.A. and Ellsworth T.R. 2009. Synthetic nitrogen fertilizers deplete soil nitrogen: a global dilemma for sustainable cereal production. *Journal of Environmental Quality* 38, 2295-2314.

N fertiliser replacement value of reversed osmosis liquid fractions on arable land

Van Dijk, W.^a, Van Geel, W.C.A.^a

^aApplied Plant Research, Wageningen University, Lelystad, The Netherlands

1. Background & Objectives

In the Netherlands due to restrictions on nitrogen (N) and phosphorus (P) use the animal manure surplus on a national level will increase the next years. One of the options to control the manure surplus level is manure processing resulting in liquid and solid fractions. Especially liquid fractions resulting from reversed osmosis (RO) separation may be assigned as a fluid mineral fertiliser if N effectiveness and environmental impact are comparable with common mineral fertilisers. Therefore, in 2009 a project was started to assess the N fertilizer replacement value (NFRV) of RO-liquid fractions on arable land as well as grassland. This paper focuses on the results on arable land. Although assessing NFRV of RO liquid fractions was the main purpose, also the application of the solid fraction was taken into account. The NFRV is defined as the percentage of total N in the product having the same effectiveness as carefully applied mineral N fertilizer.

2. Materials & Methods

In 2009 and 2010 two trials were conducted (2+2), one with ware potatoes on a marine clay soil and one with starch potatoes on a sandy soil. In all trials three RO-liquid fractions from different plants and one solid fraction were compared with the commonly used solid N fertilizer calcareous ammonium nitrate (CAN). For all products (liquid and solid fractions, CAN) there were four N application rates (0, 50, 100 and 150 kg N per ha) applied before planting. The liquid fractions were injected in the soil at a depth of 7-10 cm, the solid fraction was surface spread and incorporated within 2-4 hours after spreading. In the trials also the application of liquid fractions after planting (start tuber set) was investigated. This was done at a N rate of 50 kg N per ha for the liquid fractions as well as the reference CAN. All treatments received a base fertilisation of 100 kg N per ha with CAN before planting resulting in a total N rate of 150 kg per ha⁻¹ (60% of recommended level). The RO liquid fraction was injected between the ridges at a depth of 5-6 cm. The total N content and the mineral N fraction (% of total N) of the RO-liquid fractions varied from 4.2-8.7 kg N per ton and 89-95% respectively (Table 1). For the solid fraction values were 13-14 kg N per ton and 42-53% respectively. The supply with other nutrients than N (phosphorus, potassium, sulphur, magnesium) was set equal for all objects by supplementary dressings with mineral fertilisers. NFRV values were derived from differences in N response of the tuber N yield of the liquid and solid fraction compared to CAN by using regression analysis.

Table 1. Variation in nutrient content of the liquid and solid fractions.

Product	Total N (kg per ton)	NH ₄ -N (% of total N)	P ₂ O ₅ (kg per ton)	K ₂ O (kg per ton)
RO liquid fraction	4.2 – 8.7	89 - 95	<0.1 – 0.7	6.5 – 10.2
Solid fraction	13.0 – 14.0	47 - 58	15.3 – 15.9	4.3 – 5.2

3. Results & Discussion

For the pre plant application on both locations at all N rates marketable yield and tuber N yield on the RO liquid fractions plots were lower than on the CAN plots (data not shown). For the marketable yield this was only significant for the clay soil location in 2009, for the N yield effects were significant for both clay soil trials. For the sandy soil locations effects were not significant. The differences in effects of the three RO liquid fractions were small and not significant. The zero-

control for the liquid fractions did not differ significantly from the zero-control for CAN indicating that negative machine effects did not occur. For the post plant applications in 2009, marketable yield and tuber N yield were lower for the liquid fractions plots than for the CAN plots (significant for the marketable yield on the clay soil and significant for the N yield at both locations). In 2010 no significant differences were observed.

Based on the response of the tuber N yield it could be derived that for the pre plant application the NFRV of the liquid fractions was 78-81% for the clay soil location and 78-86% for the sandy soil location (Table 2). In order to assess whether ammonia volatilisation may have played caused the lower NFRV compared to CAN, in 2010 we also applied an acidified liquid fraction. For the clay soil no differences with the not acidified liquid fraction were found but on the sandy soil NFRV was significantly increased indicating that ammonia losses may have affected NFRV. As fertilisation with other nutrients than nitrogen was kept at the same level for all treatments this could not explain the observed differences. When applied at the start of tuber set, large differences in NFRV were observed between years. In 2009 NFRV was 0.40-0.44 while in 2010 values were 1.04-1.12. It must be emphasized that for the post plant application the calculated NFRV was based on one N rate while for the pre plant application the NFRV was based on 3 N rates. This makes it more difficult to assess the NFRV for the post plant application. The NFRV of the solid fraction was 32-34% on the clay soil and 34-55% on the sandy soil. Based on the composition of the solid fraction a value of about 60% was expected. As a substantial part of the total N is present in the form of ammonium (45-60%), ammonia volatilisation may have played a role. Although the solid fraction was incorporated in the soil this done quite superficially, so, part of the N may have been lost due to ammonia losses.

Table 2. Mean NFRV values (% of total N) of RO liquid fractions and solid fraction based on the N uptake in tubers.

Product	Clay soil		Sandy soil	
	2009 ¹	2010 ¹	2009 ¹	2010 ¹
RO liquid fraction, applied before planting ²	78*	81*	86 ns	78**
RO liquid fraction, applied at tuber set ²	44*	104 ns	40**	112 ns
Solid fraction, applied before planting	34**	32**	55*	34**

¹ average of the three liquid fractions

² *, **, *** denotes significance for difference with CAN (NFRV=100%) at P < 0.05, P < 0.01, P < 0.001; ns = not significant

4. Conclusion

The results show that the NFRV of pre plant application of RO liquid fractions are lower than 100% ranging from 78-86%. No significant differences between soil types were observed.

References

- Van Geel, W.C.A., Van Dijk, W. and Van den Berg, W. 2011. Stikstofwerking van mineralenconcentraten bij aardappelen. Verslag van veldonderzoek in 2009 en 2010. Applied Plant Research, Lelystad, report 3250131600, pp. 68.
- Velthof, G.L. 2011. Synthesis of the research within the framework of the Mineral Concentrates Pilot. Alterra, Wageningen, report 224, pp. 72.

N₂O and N₂ production, and quantification of denitrifying populations, in various aquifer systems

Barrett, M.^a, Jahangir, M.M.R.^{b,c}, Richards, K.G.^b, O'Flaherty, V.^a

^aMicrobial Ecology Laboratory, Microbiology, School of Natural Sciences & Ryan Institute, National University of Ireland Galway, University Road, Galway, Ireland

^bTeagasc, Johnstown Castle, Environmental Research Centre, Co Wexford, Ireland

^cDepartment of Civil, Structural & Environmental Engineering, Trinity College Dublin, Ireland

1. Background & Objectives

The rate of transport of nitrates to underlying groundwater systems is determined by soil type, porosity and water content (Stark and Richards, 2008). The study of microbial populations in groundwater is further complicated by the inadvertent transport to groundwater of soil microbes from the overlying soils and the continuous natural flow through aquifers. This study examined the relationship between the abundance and activity of bacterial denitrifiers in groundwater at four sites, differing with respect to overlaying land management. Groundwater was sourced from 36 multi-level piezometers, which were installed to target different groundwater zones: sub-soil, sub-soil to bedrock interface and bedrock (Jahangir et al., 2011). The gene copy concentrations (GCC) of bacterial 16S rRNA and the denitrifying functional genes, *nirK*, *nirS*, and *nosZ*, were determined using quantitative polymerase chain reaction assays.

2. Materials & Methods

Piezometers were installed in 3 separate zones: 1. subsoil (c. 5 m below ground level [bgl]) 2. subsoil-bedrock interface (c.10 m bgl) and bedrock (c.20 m bgl) in three grazed grasslands (Solohead [SH], Johnstown Castle [JC] and Dairygold [DG]) and under spring barley (Oakpark [OP]). In Dairygold [DG] only bedrock was investigated at c. 40 m bgl. Dissolved N₂ and Ar was measured using MIMS, and data was used to estimate excess N₂ (Jahangir *et al.*, 2011). Three separate replicate 5 L samples were taken from each piezometer. Samples for DNA extraction were filtered through 0.2 µm nitrocellulose membrane filters (Whatman International Ltd., England) using a vacuum pump (WELCH[®] vacuum pumps, Gardner Denver). The DNA extraction protocol used was as described previously (Barrett, 2011). Standard curves for absolute quantifications of bacterial 16S rRNA gene (*bac*) and three denitrification genes (*nirS*, *nirK* and *nosZ*) were calculated using the corresponding standard strains and primer/probe sets (Barrett, 2011). Real-time PCR quantification was performed using a Light Cycler 480 (Roche, Mannheim, Germany) in duplicate. Bacterial and archaeal 16S rRNA genes were analyzed using the LightCycler 480 Taqman hydrolysis probe Master kit (Roche), and the corresponding primer/probe sets and LightCycler 480 Probe Master kit (Roche), as described previously (Barrett, 2011).

3. Results & Discussion

The *nirK*, *nirS*, nir^T ($nirK + nirS = nir^T$) and *nosZ* GCCs varied significantly? between sites, for example OP and DG experimental sites, while some variations were also observed between piezometers within sites (Figure 1). Importantly, however, and at each of the sites, *nosZ* GCCs correlated significantly with the presence and quantity of N₂ ($P < 0.0001$). No significant correlation was recorded between the *nirK* or *nirS* GCCs and N₂O measurements ($p=0.2646$). Groundwater bacterial 16S rRNA (Bac) concentrations across the four sites ranged 10³-10⁴ for all piezometers.

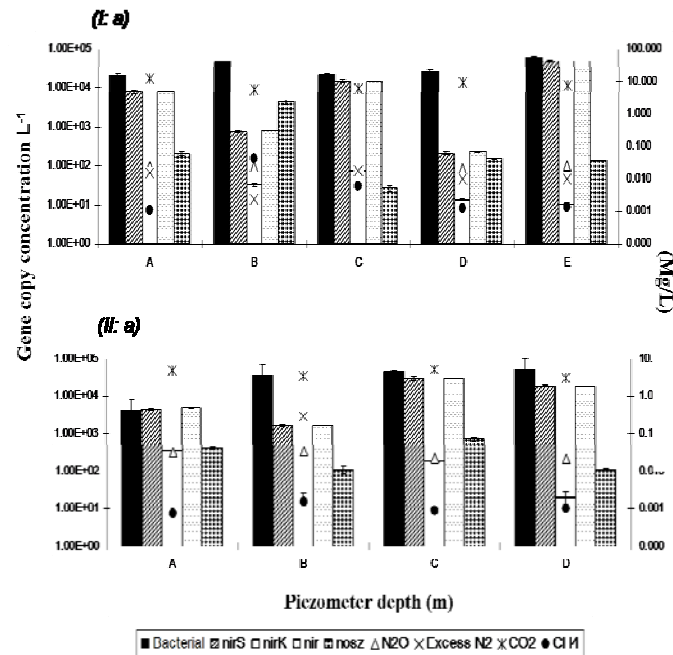

Figure 1. Mean groundwater *nirK*, *nirS*, *nosZ* and bacterial 16S rRNA GCC L⁻¹ filtered at (OP I:a) spring barley, (Depth – A & B=5 m) (Depth – C & D=10 m); (Depth – E=20 m) (II:a) DG grazed clover ryegrass grassland.

A significant depth by GCC interaction ($p=0.0012$) was observed with GCCs for the various denitrifier genes being similar across comparable piezometer depths (c. $10^2 - 10^3 - 10^4$). Piezometer depth was significantly correlated ($p=0.0256$) with *nirS* GCC but no significant correlations were observed with *nirK*, *nir^T* or *nosZ* ($p>0.05$). A significant temporal correlation was noted between *nirS* and piezometer depth ($p=0.0256$), but not between *nirK* and piezometer depth ($p=0.9797$). Mean $N_2O:(N_2O + N_2)$ ratios decreased with aquifer depth (0.05 in subsoil to 0.01 in bedrock) indicating that N_2O reduction to N_2 occurred as groundwater moved vertically. Excess N_2 was positively correlated with DOC ($r=0.73$) and water table depth ($r=0.330$), and negatively correlated with DO ($r=0.70$) and K_{sat} ($r=0.47$). Groundwater *Nir* abundance was positively correlated to N_2O production ($P < 0.0001$).

4. Conclusion

The positive correlation between groundwater *nosZ* abundance and excess N_2 concentrations indicated that determination of *nosZ* abundance could be used as a potential indicator of complete groundwater denitrification. Variations in the abundance of *nirK* and *nirS*- carrying microbes could be linked with land management practices thus determining a direct impact of land use on groundwater denitrifer abundance.

5. References

- Barrett, M. 2011. Investigating the occurrence and activity of denitrifying microbial communities with relation to subsoil and groundwater denitrification capacity. PhD thesis.
- Jahangir, M.M.R. 2011. Denitrification in subsoils and groundwater in Ireland. PhD thesis, School of Engineering, The University of Dublin, Trinity College, Ireland.
- Stark, C.H and Richards, K.G 2008. The continuing challenge of agricultural nitrogen loss to the environment in the context of global change and advancing research. *Dynamic Soil, Dynamic Plan* Volume 2, 1-12.

N₂O emission from a maize cropping system influenced by replacing fallow with cover crops and its subsequent incorporation into the soil.

García-Marco, S.^a, Sanz-Cobeña, A.^a, Gabriel, J.L.^b, Almendros, P.^a, Quemada, M.^b and Vallejo, A.^a

^a Dpto. Química y Análisis Agrícola, ETSI Agrónomos, Technical University of Madrid, Ciudad Universitaria, 28040 Madrid, Spain

^b Dpto. Producción Vegetal: Fitotecnia, ETSI Agrónomos, Technical University of Madrid, Ciudad Universitaria, 28040 Madrid, Spain

1. Background & Objectives

Application of nitrogen (N) fertilizers in agricultural soils increases the risk of N loss to the atmosphere in the form of ammonia (NH₃), nitrous oxide (N₂O) and nitric oxide (NO) and the water bodies as nitrate (NO₃⁻). The implementation of agricultural management practices can affect these losses. In Mediterranean irrigation systems, the greatest losses of NO₃⁻ through leaching occur within the irrigation and the intercrop period. One way to abate these losses during the intercrop period is the use of cover crops that absorb part of the residual N from the root zone (Gabriel and Quemada, 2011). Moreover, during the following crop, these species could be applied as amendments to the soil, providing both C and N to the soil. This effect of cover and catch crops on decreasing the pool of N potentially lost has focused primarily on NO₃⁻ leaching. The aim of this work was to evaluate the effect of cover crops on N₂O emission during the intercrop period in a maize system and its subsequent incorporation into the soil in the following maize crop.

2. Materials & Methods

Fifteen plots were set in the field and five cover cropping treatments, barley (*Hordeum vulgare* L.), vetch (*Vicia villosa* L.), rape (*Brassica napus* L.), bare fallow and bare fallow without previously N fertilization as a control soil, were arranged in a fully randomized design with three replicates. Cover crops were broadcast in October 2009 and treated with glyphosate in March 2010. The cover crop residue was incorporated by ploughing to the soil in half of each plot and removed in the other half. Maize was sowed in April 2011 and harvested in September 2010. Irrigation during the maize crop was applied according to crop evapotranspiration. Each plot received 120 kg ha⁻¹ of P and K (before sowing maize) and 150 kg N ha⁻¹ as NH₄NO₃ split in two applications (2/3 at the end of May and 1/3 at the end of June) except in the bare fallow soil without N application. N₂O emissions were sampled using the chamber technique (Roelle et al., 1999) and analyzed by gas chromatography

using a HP-6890 gas chromatograph equipped with a Plot-Q capillary column and a ⁶³Ni micro electron-capture detector (μECD).

3. Results & Discussion

In the intercrop period, N₂O emissions from soil were influenced by the presence of cover crops (Figure 1). The presence of barley and rape decreased N₂O emission but not significantly ($P > 0.05$).

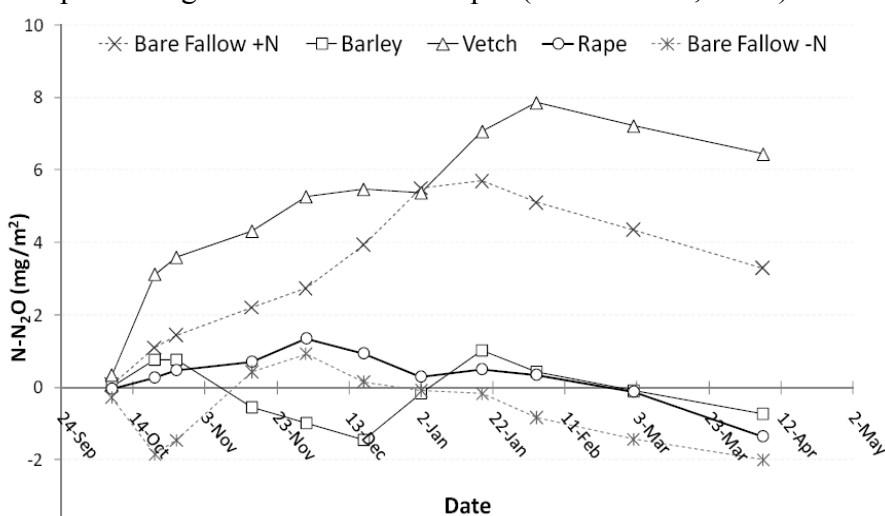

Figure 1. Cumulative N₂O fluxes from soils in the intercropping period.

In contrast, emissions from the vetch increased ($P=0.001$) in the same period. That different cover crop behaviour could be due to the fact that vetch is a legume that fixes atmospheric N_2 resulting in a lower uptake of residual N and soil mineral N accumulation (Gabriel and Quemada, 2011).

During the maize crop, N_2O emission was influenced by the application of N fertilizer and the incorporation of cover crop residues (Figure 2). N_2O emissions were higher ($P>0.05$) in the N fertilized soils and also increased once that the barley and rape straws were incorporated into the soil in comparison with the no-residue incorporation. However, the opposite effect occurred when vetch residues were used as green manure. Mineralization of plant residues and thus the N_2O emission was found to be dependent on the C:N ratio of the residues (Eichner, 1990) and the amount of C in the incorporated biomass. Lower C:N ratio of the residues induce higher concentration of DOC and larger amount of N_2O emission (Huang et al., 2004). Barley and rape residue incorporation might stimulate microbial growth and activity and thus resulting in a higher denitrification capacity.

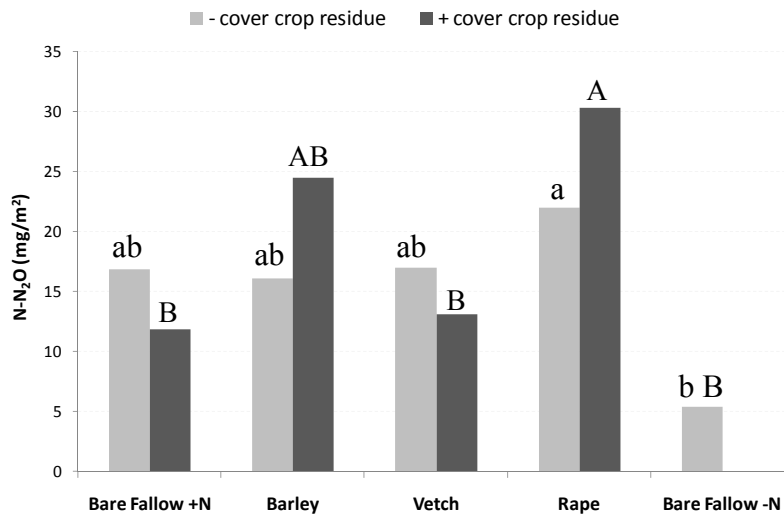

Figure 2. Cumulative N_2O fluxes from soils in the maize crop without and with cover crop residue incorporation.

4. Conclusion

This study underlines the role of the use of barley and rape cover crops in intercropping periods as a N_2O abatement strategy. In contrast, the incorporation of barley and rape residues increased these emissions. Based on these results, its addition cannot be regarded as a good mitigation strategy under the conditions of the experiment.

References

- Gabriel, J.L. and Quemada, M. 2011. Replacing bare fallow with cover crops in a maize cropping system: Yield, N uptake and fertiliser fate. *European Journal of Agronomy* 34, 133-143.
- Eichner, M.J. 1990. Nitrous oxide emissions from fertilized soils: summary of available data. *Journal of Environmental Quality* 19, 272-280.
- Huang, Y. et al., 2004. Nitrous oxide emissions as influenced by amendment of plant residues with different C:N ratios. *Soil Biology & Biochemistry* 36, 973-981.
- Roelle, P. et al., 1999. Measurement of nitrogen oxide emissions from an agricultural soil with a dynamic chamber system. *Journal of Geophysical Research* 104, 1609-1619.

Nitrate leaching after cattle slurry application to ley in autumn

Delin, S.^a, Stenberg, M.^a, Engström, L.^a

^aDepartment of Soil and Environment, Swedish University of Agricultural Sciences, Skara, Sweden

1. Background & Objectives

The nitrate directive (EEC, 1991) has led to new restrictions for manure application within nitrate vulnerable zones. In Sweden this means that slurry application to growing leys in autumn is not allowed after 31st October, based on the assumption that with an earlier application, nitrogen is more utilisable by the grass. There is however little scientific evidence that the risk for nitrate leaching is higher when slurry is applied in November than earlier in autumn. The objective with this study was to compare leaching effects between slurry application to ley in early autumn, late autumn and spring.

2. Materials & Methods

Nitrate leaching was measured after application of 30-45 tonnes ha⁻¹ (50-60 kg NH₄ N ha⁻¹) of cattle slurry in early autumn (September), late autumn (November) or spring (April) to first- and second year forage grass and clover ley on a sandy loam soil in Sweden. One ley was established in 2009 and the other in 2010 with one two-year experiment in each ley during 2009-2011 and 2010-2012 respectively. Each experiment had four treatments (three manure treatments and one unmanured control) randomized into seven blocks. Yield was measured in three harvests each year after manure application. Soil water was sampled with ceramic suction cups (Djurhuus, 1990) installed in triplicate at 80 cm depth in each plot. Sampling was carried out bi-weekly during periods with water runoff, from the time of the earliest fertilisation until December the second year of harvesting. The sampled water was analyzed for nitrate (NO₃-N), and nitrate leaching is determined from NO₃-N concentrations in soil water and discharge measured at a nearby measuring station during the sampling period, accounting for both direct and residual effects. Soil samples (0-60 cm depth) were taken at the end of autumn (December) for determination of NH₄-N and NO₃-N. Subsamples of 30 g were extracted with 100 ml 2 M KCl extract. Just before late manure application and in early spring in the winter 2009/2010 the plants were sampled by cutting plants at the soil surface in four 0.25 m² areas within each plot. The plant samples were dried at 60°C, weighed and analysed for total nitrogen content. Treatment effects were tested statistically by variance analysis.

3. Results & Discussion

Soil mineral nitrogen (NO₃-N + NH₄-N) levels in December 2009 were elevated around 6 kg N ha⁻¹ in autumn-manured treatments compared to the other treatments. Aboveground plant nitrogen was at this time about 40 kg N ha⁻¹ after early application compared to around 25 kg N ha⁻¹ in the other treatments. In April, aboveground plant nitrogen was about 10 and 5 kg N ha⁻¹ higher in the early and late autumn-manured treatments, respectively, than in unmanured treatments. Nitrate leaching during September-August this year tended to be higher in the treatment with late autumn application, but differences were not statistically significant (Figure 1).

Soil mineral nitrogen levels in December 2010 were elevated by around 15 kg N ha⁻¹ in early autumn-manured treatment and 30-40 kg N ha⁻¹ in late autumn-manured treatment. Nitrate leaching during October-August this year was significantly higher from autumn manured treatment than from the other two treatments in both the first and second year ley, but there were no significant difference between early and late autumn application (Figure 1).

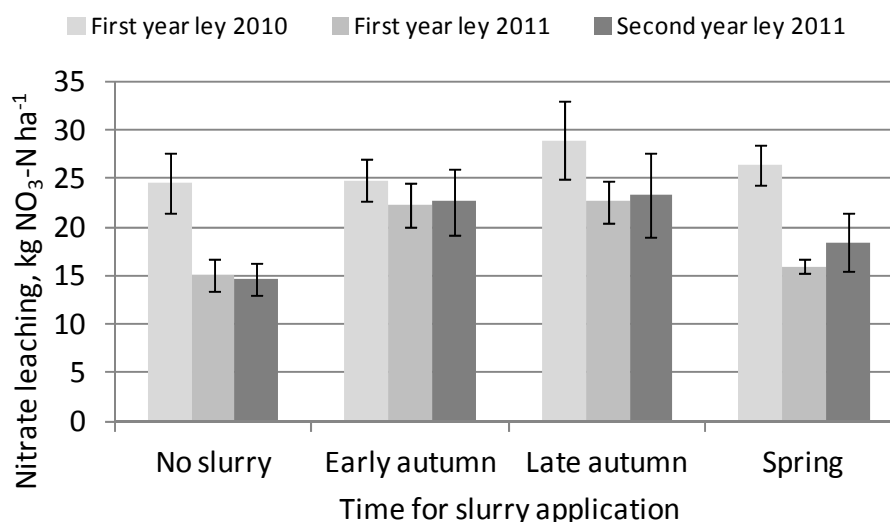

Figure 1. Nitrate leaching from ley (error bars with standard error) September–August.

Total dry matter yields did not differ significantly between treatments in 2010, but in the spring manured treatment yield was a bit lower from the first cut, which was compensated by higher yield than in other treatments in the second cut. This indicates that some of the nitrogen from spring-applied slurry came too late for the first harvest, but could be utilized in the next. In 2011, spring manured treatments yielded a bit more (4500 kg ha^{-1} compared to 4000 kg ha^{-1}) than the other treatments, probably due to a higher $\text{NH}_4\text{-N}$ content (90 compared to $60 \text{ kg NH}_4\text{-N ha}^{-1}$) in manure at this application date. The intention was to apply $50 \text{ kg NH}_4\text{-N ha}^{-1}$ at all dates, but this was exceeded due to underestimation of ammonium concentration in slurry at the time of application in autumn 2010, and especially in spring 2011.

The higher and significant effects from autumn application on nitrate leaching during the second year may be due to the higher rate of slurry applied or to larger drainage runoff during winter.

4. Conclusion

The leaching increased by $0\text{-}15 \text{ kg N ha}^{-1}$ after application of slurry in autumn compared to no slurry application or application in spring with no significant difference in leaching depending on how late in autumn slurry was applied. Since the effect on leaching was significant only when application rates were higher than intended ($>60 \text{ kg ha}^{-1}$), autumn application may be appropriate as long as rates are limited. However, more results are needed before such limits can be defined.

References

- Djurhuus, J. 1990. Sammenligning af nitrat i jordvand udtaget med sugkopper og ekstrahert fra jordprøver. Landbrugsministeriet, Statens Planteavlsvforsøg, Særtryk af Tidsskrift for Planteavl 94, 487-495.
- EEC, 1991. Council Directive 91/676/EEC of 12 December 1991 concerning the protection of waters against pollution caused by nitrates from agricultural sources

Nitrogen dynamics in agricultural Mediterranean catchments vs. temperate ones: Ebro, Oglio, Seine and Scheldt comparisons

Lassaletta, L.^{a,b}, Bartoli, M.^c, Billen, G.^a, Garnier, J.^a, Grizzetti, B.^a, Romero E.^a, Soana E.^c, Viaroli, P.^c

^aCNRS/UPMC, UMR 7619 Sisyphe, 4 place Jussieu, 75005 Paris, France

^bDepartment of Ecology, Universidad Complutense de Madrid, c/ José Antonio Novais 28040 Madrid, Spain

^cDepartment of Environmental Sciences, University of Parma, Viale G.P. Usberti 33/A, 43124 Parma, Italy

1. Background & Objectives

Ecological processes in regions with Mediterranean climates are affected in different ways than those subject to other climatic conditions. N inputs in Mediterranean catchments have been estimated to be lower than those in temperate European catchments (Grizzetti et al., 2011) but this does not fully justify the very low N loads finally exported to the Mediterranean Sea. Romero et al. (submitted) have recently shown how N fluxes from Mediterranean catchments to the sea are on average over two times lower than those observed in European temperate catchments. A recent study conducted in the Ebro, a characteristic Mediterranean catchment, has shown that a high proportion of all N inputs never reach the sea, and this is due to the particular management that typifies agricultural areas in this type of climate (Lassaletta et al., 2012). On the other hand, in the Oglio, an affluent of the Po river, Bartoli et al. (2012) have estimated one of the highest fluvial N exports observed in a river outlet. The main objective of the present work is to synthesize and compare the information on N dynamics and retention from two Mediterranean and two temperate catchments, and to identify the main discrepancies and similarities.

2. Materials & Methods

Four highly monitored catchments have been chosen: two under Mediterranean climate (the Ebro and the Oglio River Basins, in Spain and Italy respectively) and two in temperate areas (the Seine and the Scheldt River Basins, in France and Belgium) (Table 1). These catchments are relatively homogeneous in terms of agricultural surface but rather heterogeneous in terms of runoff, population density and livestock uses. We performed a *soil system balance* (Lassaletta et al., 2012) in the agricultural areas to estimate diffuse sources. Point sources and N retention in the catchment were also estimated based on national statistics. The term “retention” is used to designate all the processes preventing nitrogen load from being transferred to the outlet of the drainage network.

Table 1. Characteristics of the catchments considered in this study.

Catchment	Seine	Scheldt	Ebro	Oglio (Po)
Climate	Temperate	Temperate	Mediterranean	Mediterranean
Surface (km ²)	71700	19860	85566	3840
Agriculture (%)	59	61	48	60
Runoff (mm)	310	327	116	500
Autot./Heterot.	Autotrophic	Hererotrophic	Hererotrophic	Hererotrophic
Inhab/km ²	213	493	34	333
Livestock Units/km ²	15	70	44	106
Mineral Fertilizer (kgN/agricHa)	153	91	53	151

3. Results & Discussion

According to the soil system balance, the Oglio catchment is the most intensively managed in terms of agricultural surpluses followed by the Scheldt catchment. This is related to the application of high amounts of N in the form of manure generated by the high livestock densities. Both catchments have also the highest population densities and the highest point sources contribution. On the other hand we have the Ebro basin, with lower agricultural surpluses, roughly on the order of those found in the Seine basin. These values are however in the medium-high range of the European catchments (Billen et al., 2011). The retention in the Ebro catchment is clearly the highest, which means that many of the N inputs to the catchment never reach the coast through river export.

Table 2. Results of the soil system balance, point sources, N river export and N retention in the studied catchments.

kg N km ⁻² y ⁻¹	Seine	Scheldt	Ebro	Oglio
Agricultural surplus	4845	8480	4339	10088
Point sources	550	1050	174	1462
River export	1950	2310	394	3278
N retention (%)	64	76	91	72

This unusual high retention has been related to the intense water regulation (by means of numerous dams and channels) that characterizes Mediterranean semi-arid agricultural catchments (Lassaletta et al., 2012). The Oglio catchment represents an opposite case. Despite being located in a Mediterranean area, the runoff is the highest of the four catchments studied and this, together with the very high agricultural inputs, results in a high amount of N being exported outside the catchment. Bartoli et al. (2012) have shown, however, how the dense channel network typical of Mediterranean catchments can induce high N retentions and also high N₂O emissions.

4. Conclusion

Mediterranean catchments can have very high N retention percentages when the catchment is semiarid, highly regulated and has low runoff levels. Despite being located in Mediterranean areas, highly impacted catchments with high runoff values can present a behavior that is similar to that of catchments placed on temperate ecosystems. Nitrogen dynamics and some pollution-associated problems can be very different according to catchment characteristics such as climate and water regulation. Further research should address the fate of the nitrogen which is retained, in particular verify whether it is permanently lost via denitrification or temporarily accumulated in soils or in the groundwater.

References

- Bartoli, M., Racchetti, E., Delconte, C.A., Sacchi, E., Soana, E., Laini, A., Longhi, D. and Viaroli, P. 2012. Nitrogen balance and fate in a heavily impacted watershed (Oglio River, Northern Italy): In quest of the missing sources and sinks, *Biogeosciences* 9, 361-373.
- Billen, G., Silvestre, M., Grizzetti, B., Leip, A., et al. C.: 2011. Nitrogen flows from European regional watersheds to coastal marine waters, in: *The European Nitrogen Assessment*, edited by: Sutton, M. A., et al. Cambridge University Press, New York, 271-297.
- Grizzetti, B., Bouraoui, F. and Aloe, A. 2012. Changes of nitrogen and phosphorus loads to European seas. *Global Change Biology* 18, 769-782.
- Lassaletta, L., Romero, E., Billen, G., Garnier, J., García-Gómez, H. and Rovira, J. V. 2012. Spatialized N budgets in a large agricultural Mediterranean watershed: High loading and low transfer. *Biogeosciences* 9, 57-70.
- Romero E., Garnier J., Lassaletta L., Billen G., Le Gendre R., Riou P. and Cugier P. 2012. Large-scale patterns of river inputs in SW Europe: seasonal and interannual variations and potential eutrophication effects, *Biogeochemistry*, submitted.

Nitrogen dynamics in maize based cropping systems for biogas production

Sieling, K.^a, Herrmann, A.^b, Wienforth, B.^a, Ohl, S.^c, Taube, F.^b, Kage, H.^a

^aInstitute of Crop Science and Plant Breeding; Agronomy and Crop Science; Christian-Albrechts-University, Kiel, Germany

^bInstitute of Crop Science and Plant Breeding; Grass and Forage Science/Organic Agriculture; Christian-Albrechts-University, Kiel, Germany

^cInstitute of Agricultural Engineering; Christian-Albrechts-University, Kiel, Germany

1. Background & Objectives

Biogas production has gained importance as a contribution to climate change mitigation, notably in Germany. Biogas residues (BR), which are produced in large amounts, thus should be used in a sustainable way. Anaerobic digestion was shown increase the short-term N availability (Gutser et al., 2005), but also to promote ammonia emission (Gericke, 2009). Data on the fertiliser value of BR from co-fermentation is still limited. This paper aims to investigate the N supplying potential of co-digestion residues to maize monoculture and a maize rotation in terms of N balance, methane yield, and apparent N recovery (ANR), based on a 2-year field trial conducted in northern Germany.

2. Materials & Methods

A 2-year field trial (2007-2009) was established as 4-factorial randomized block design with 4 replicates at Hohenschulen experimental station (750 mm, 8.3°C; luvisol) of Kiel University. Treatments comprised crop rotation (R1: maize monoculture, R2: maize-whole crop winter wheat-Italian ryegrass as catch crop), N fertilizer type (calcium ammonium nitrate (CAN), biogas residue (Mix), pig slurry (Pig)), and N amount (maize, wheat: 0, 120, 240, 360 kg N ha⁻¹; Ital. ryegrass: 0, 80 kg N ha⁻¹ for each of two cuts). Each crop of R2 was grown in each year. The N balance was calculated as difference between N fertilization and crop N offtake. Specific methane yield (SMY; l_N CH₄ kg⁻¹ OM) of the CAN and Mix treatments was obtained by the Hohenheim Biogas Yield Test (Helffrich and Oechsner, 2006). The relation between N amount and methane yield, N balance and ANR was quantified by SAS 9.2 Proc NLIN assuming a 'Linear-Plateau' model. Function parameters were compared by a modified t-test based on Zar (2009). Total N of organic fertilizers had been corrected for NH₃-N losses during application as estimated by Gericke (2009).

3. Results & Discussion

Methane yield production, N offtake and N balance were not affected by N fertilizer type, while rotation showed a significant impact on N dynamics and on maize yield performance. Maize monoculture achieved a maximum methane hectare yield of 6,774 m³_N CH₄ ha⁻¹ at the N rate of 122 kg N ha⁻¹ as Mix (Figure 1a). Rotation R2 had a significantly lower yield of 5,302 m³_N CH₄ ha⁻¹, which, however, required an N input of 257 kg N ha⁻¹. The superiority in yield of R1 was due to higher dry matter yield of maize, while differences in SMY among crops were small. Higher N contents of wheat and Italian ryegrass resulted in higher N offtake of R2 compared to R1 (Figure 1b). However, R2 required a significantly higher N input to achieve its N offtake maximum, whereas for the unfertilized control, N offtake of R2 was considerably lower than for R1. Consequently, the N balance at N input required for maximum methane yield (N_{opt}) was significantly lower for R1 (Figure 1c). The apparent N recovery (ANR) of R2 remained constant at values of 72% (CAN), 63% (Mix), and 70% (Pig) for N input below 250 kg N ha⁻¹ (CAN, Pig) or 280 kg N ha⁻¹ (Mix) (Fig. 1d), whereas it decreased nonlinearly above, resulting in similar curves for all fertilizer types. Mix applied to R2 revealed a short-term N fertilizer value below that of pig slurry, which is in accordance to the lower NH₄-N content of Mix (53.0%) compared to pig slurry

(72.0%) and a higher NH_3 volatilization (Gericke, 2009). For R1, however, Mix showed a higher fertilizer value than Pig. This might be due to different temporal characteristics of N leaching, although the total leaching loss observed over the 2-year period was similar for Mix and Pig (Svoboda, 2011). Higher mineralization of organically bound N in Mix, due to a lower C/N ratio, and non-N effects seem unlikely. Because of their high plant N availability, BR, as liquid animal manure, present a considerable risk of nitrate leaching when the amount and timing of N fertilization is not adjusted to meet crop N demand. Mitigation of nitrate leaching by growing maize in a crop rotation proved effective in case of N oversupply (Svoboda, 2011).

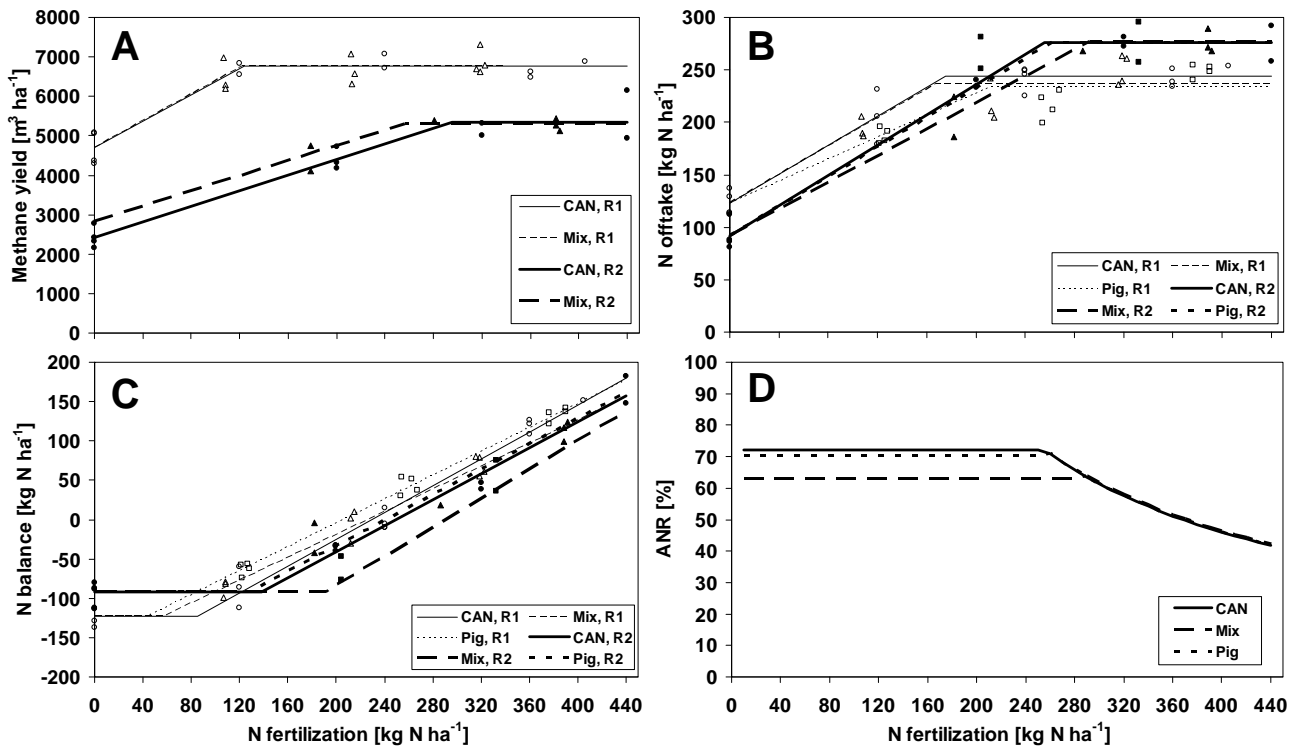

Figure 1. Average annual methane yield ($\text{m}^3_{\text{N}} \text{CH}_4 \text{ha}^{-1}$) (a), N offtake (b), N balance (c) and apparent N recovery (ANR) (d) of crop rotations R1 (thin lines, open symbols) and R2 (bold lines, closed symbols) fertilized with varying amounts of mineral N (solid lines, circles), biogas residue (broken lines, triangles) and pig slurry (dotted lines, squares).

4. Conclusion

BR provide a valuable nutrient source which can reduce GHG emissions when replacing fossil fuel based fertilizer. If properly managed, they do not increase the risk of environmental impact compared to liquid animal manure. Long-term effects need to be evaluated by model simulations.

References

- Gericke D. 2009. Measurement and modelling of ammonia emissions after field application of biogas slurries. Doctoral thesis, Christian-Albrechts-Universität, Kiel, German.
- Gutser, R., Ebertseder, T., Weber, A., Schraml, M. and Schmidhalter U. 2005. Short-term and residual availability of nitrogen after long-term application of organic fertilizers on arable land. *J. of Plant Nutrition and Soil Science* 168, 439-446.
- Helffrich D. and Oechsner H. 2003. The Hohenheim Biogas Yield Test. *Landtechnik* 58, 148-149.
- Svoboda N. 2011. Auswirkung der Gärrestapplikation auf das Stickstoff-Auswaschungspotential von Anbausystemen zur Substratproduktion. Doctoral thesis, Christian-Albrechts-Universität, Kiel, Germany
- Zar, J.H. 2009. *Biostatistical Analysis*. 5th Edition, Prentice Hall, 960 p.

Nitrogen losses from buffer zones: interactions with soil structure and hydrological pathways

Carswell, A.M.^{a,b}, Blackwell, M.S.A.^a, Bol, R.^a, Chadwick, D.^a, Hawkins, J.M.B.^a, Johnes, P.^b, Whalley, R.^c

^a Rothamsted Research, North Wyke, Okehampton, Devon, U.K.

^b University of Reading, Whiteknights, Reading, Berkshire, U.K.

^c Rothamsted Research, West Common, Harpenden, Hertfordshire, U.K.

1. Background & Objectives

Pollution of surface waters by agriculturally derived nutrients, especially nitrogen (N) and phosphorus (P), is well known to cause eutrophication and has implications for drinking water quality. Implementation of buffer zones, at the downslope edge of agricultural fields, to mitigate diffuse nutrient pollution of surface waters is endorsed by Defra (Department for Environment, Food and Rural Affairs), as an option to gain Entry Level Stewardship status (Defra, 2010), whereby grants are awarded for environmentally beneficial land management techniques. However, hydrological bypassing, via artificial drainage, is known to reduce the efficacy of buffer zones (Leed-Harrison et al., 1999). Installation of a permeable reactive barrier (PRB) to intercept artificial drainage flow has the potential to increase flow residence time and provide optimal conditions for nutrient capture or transformation (Schipper et al., 2010; Grimsey, 2011) within the buffer zone. The objectives of this study are to examine two key questions (1) whether the drained buffer zone works to capture and transform different N forms; and (2) whether installation of PRBs within buffer zones can be used to intercept drainage flow and encourage full denitrification of potential surface water pollutants. The application and examination of the efficiency of PRBs in conjunction with a buffer zone in a drained intensive grassland makes this work innovative, especially with regard to the replication and large scale at which investigations are being carried out (see below).

2. Materials & Methods

The study site is the North Wyke Buffer Zone Experiment, Rothamsted Research, Devon, England. The experimental setup comprises three replicated buffer zone treatments, shown in Figure 1. Plots are hydrologically isolated on a uniform slope of approximately 5° and comprise a 40 m x 10 m drained grassland plot with (1) no buffer (control); (2) a 6 m wide buffer zone; and (3) a 6 m wide buffer zone with a PRB installed upslope. The

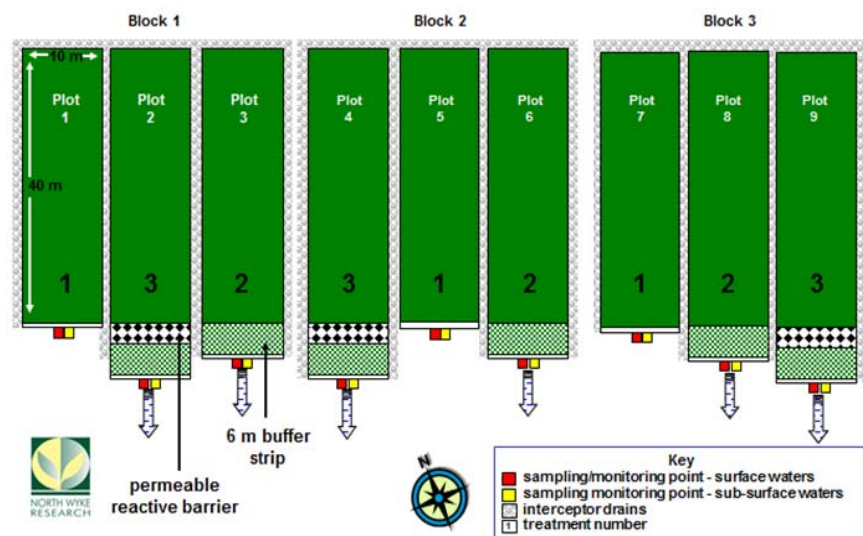

Figure 1. Plan of the Buffer Zone Experiment at Rothamsted Research, North Wyke, Devon, England.

PRB material consists of a wheat straw carbon (C) source, for denitrification processes, and gypsum (derived from crushed plasterboard) for P removal (Grimsey, 2011). The plots were amended with slurry in October 2011, in line with intensive grassland management. Surface and sub-surface flow samples were collected using flow proportional sampling during the storm of 12th-13th December 2011, which had a precipitation total of 23.2 mm. Samples were analysed for dissolved (<0.45 µm)

total oxidised N (TO_xN) and ammonium-N (NH_4^+) using a Thermo Fischer Aqua Kem 250, discrete photometric analyser.

3. Results & Discussion

Results from the analyses of the 12th-13th December 2011 storm samples are shown for each treatment in Figure 2. Sub-surface flow samples for the control (rep. 1) and the buffer zone with PRB (rep. 3) were not taken due to equipment failure. Mean total flow volumes ($n = 3$; \pm standard error) for the surface flow of the control, buffer and buffer with PRB were 4.9 ± 0.6 , 3.0 ± 0.7 , $4.8 \pm 2.3 \text{ m}^3$ respectively and for the sub-surface flow of the control, buffer and buffer with PRB were 15.7 ± 0.2 , 19.5 ± 4.9 and $17.0 \pm 2.2 \text{ m}^3$ respectively. Highest mean values of TO_xN were found in the buffer treatment at 0.87 mg L^{-1} for both surface and sub-surface flow, whereas minimum mean values were 0.05 mg L^{-1} in the surface flow of the buffer with PRB. Highest mean NH_4^+ concentrations occurred in the surface flow and lowest mean concentrations in the sub-surface flow of the buffer with PRB of 0.32 mg L^{-1} and 0.03 mg L^{-1} respectively. A general trend of higher mean NH_4^+ values in the buffer and buffer with PRB treatments relative to the control in the surface flow is observed. However, variation amongst the concentrations of TO_xN and NH_4^+ is not significant ($p < 0.05$ ANOVA Genstat 14) for any of the treatments. This is not surprising due to the PRB being newly installed and it may require time to commence full functionality. Also the processes (e.g. denitrification) that are primarily responsible for nutrient transformation and removal are microbiologically driven, and typically operate at low levels during colder, winter months. These results imply that where buffer zones and buffer zones with PRBs are artificially drained they have little impact on the capturing and transformation of TO_xN and NH_4^+ .

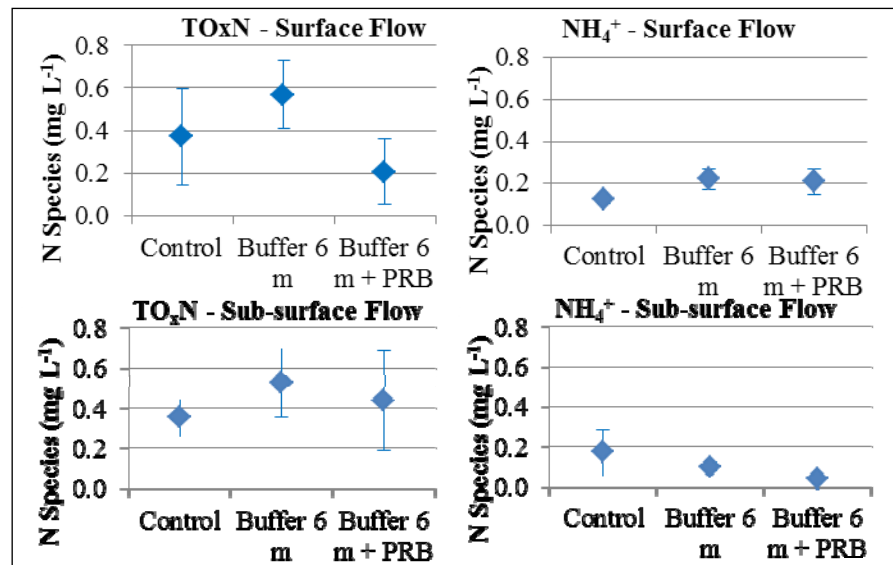

Figure 2. Mean concentrations of TO_xN and NH_4^+ from 12th-13th December storm for each treatment and standard error bars where $n = 3$ for all except sub-surface flow Control and Buffer 6 m + PRB where $n = 2$.

Highest mean values of TO_xN were found in the buffer treatment at 0.87 mg L^{-1} for both surface and sub-surface flow, whereas minimum mean values were 0.05 mg L^{-1} in the surface flow of the buffer with PRB. Highest mean NH_4^+ concentrations occurred in the surface flow and lowest mean concentrations in the sub-surface flow of the buffer with PRB of 0.32 mg L^{-1} and 0.03 mg L^{-1} respectively. A general trend of higher mean NH_4^+ values in the buffer and buffer with PRB treatments relative to the control in the surface flow is observed. However, variation amongst the concentrations of TO_xN and NH_4^+ is not significant ($p < 0.05$ ANOVA Genstat 14) for any of the treatments. This is not surprising due to the PRB being newly installed and it may require time to commence full functionality. Also the processes (e.g. denitrification) that are primarily responsible for nutrient transformation and removal are microbiologically driven, and typically operate at low levels during colder, winter months. These results imply that where buffer zones and buffer zones with PRBs are artificially drained they have little impact on the capturing and transformation of TO_xN and NH_4^+ .

4. Conclusions

Results suggest that the presence of buffer zones or buffer zones with PRBs in drained intensive grasslands do not result in significant changes in water quality and/or that N loading of the treatments was low due to flushing from a previous storm or due to plant uptake. Efficacy of buffer strips and PRBs requires assessment over a range of storm intensities and seasonally different antecedent conditions, particularly following amendment of a N source

References

- DEFRA 2010. Entry Level Stewardship Handbook. *In*: Department for the Environment, Farming and Rural Affairs (ed.) Third ed. London: Natural England.
- Grimsey, V. 2011. Evaluation of different permeable reactive barrier (PRB) materials for the control of diffuse pollutants from agriculture, M.Sc. Dissertation, Lancaster University, Lancaster, UK.
- Schipper, L.A., Robertson, W.D., Gold, A.J., Jaynes, D.B. and Cameron, S.C. 2010. Denitrifying bioreactors-An approach for reducing nitrate loads to receiving waters. *Ecological Engineering*, 36, 1532-1543.

Nitrogen mass balance in a coastal lowland declared vulnerable to nitrate (WFD 2000/60/EC): the relevance of secondary canals in excess nitrogen removal

Castaldelli, G.^a, Pierobon, E.^a, Soana E.^b, Salemi E.^c, Aschonitis V.G.^d, Colombani N.^c, Mastrocicco M.^c, Bartoli M.^b

^aDepartment of Biology and Evolution, University of Ferrara, Ferrara, Italy

^bDepartment of Environmental Sciences, University of Parma, Parma, Italy

^cDepartment of Earth Sciences, University of Ferrara, Ferrara, Italy

^dSchool of Agriculture, Aristotle University of Thessaloniki, Thessaloniki, Greece

1. Background & Objectives

The Po di Volano Basin (687.5 km²) is a recently reclaimed alluvial territory, located south of the Po River Delta (northeast Italy) and characterized by flat topography, intense agriculture and low population density. Under European Water Framework Directive (2000/60/EC) the whole basin has been designated as nitrate-vulnerable zone (NVZ). The objective of this work is to calculate a comprehensive nitrogen budget, both for superficial soils and the hydrological network, and compare individual terms to assess their reliability, particularly with respect to soil nitrogen losses and removal processes via denitrification.

2. Materials & Methods

Nitrogen soil budget was carried out on annual basis from 2006 to 2008, according to Oenema et al. (2003). The main inputs and outputs for N cycle in terrestrial agroecosystems were considered with associated errors and included in the equation modified from Isidoro et al. (2006). Balance calculations were performed at a spatial resolution of 26 municipalities, expressed as t N yr⁻¹, and aggregated on the watershed scale, using ArcView GIS 3.2 software (ESRI, California) (Soana et al., 2011). Input from urban and point sources were not taken into account in the final balance, because their magnitude resulted negligible. The nitrogen loads of the hydrological network were calculated according to Kronvang and Bruhn (1996), and Letcher et al. (2002), using discharge data, registered monthly and weekly by Hydraulic Authorities and nitrogen concentrations, measured monthly by the Emilia-Romagna Environmental Protection Agency.

3. Results

Average annual budget of nitrogen in soil, calculated at the basin scale from 2006 to 2008, is reported in Table 1.

Table 1. Mean annual values and standard error of inputs and outputs in the soil mass balance.

INPUT	t N y ⁻¹	se
Fertilization	28.502	1.850
Biological fixation	8.450	2.952
Atmospheric deposition	634	7
Σ input	37.585	4.809
OUTPUT		
Residual in soil	3.012	593
Crop uptake	21.574	5.897
NH ₃ volatilization	4.451	1.553
Denitrification in soils	2.678	710
Σ output	31.716	8.752
Σinput - Σoutput	5.869	13.561

Yearly hydraulic and nitrogen loads, coming in and exiting the basin, are presented in Table 2.

Table 2. Inputs and outputs of water, nitrate (N-NO₃⁻), dissolved inorganic nitrogen (DIN) and total nitrogen (TN) through the hydrological network.

		Input		Output		N removal	
		mean	se	mean	se	mean	se
WATER	10 ⁶ m ³	906	98	654	54		
N-NO ₃ ⁻	tons N	1.475	487	1.020	251	-454	299
DIN	tons N	2.119	343	1.670	304	-449	79
TN	tons N	3.819	368	2.707	256	-1.112	285

The hydrological network exported 2.707 ± 256 tN y⁻¹ of nitrogen to the coastal area, of which 36% in form of nitrate. The mean annual removal of nitrogen was 1.112 ± 285 tons, with the highest values in summer months.

4. Discussion & Conclusion

The nitrogen balance in soils ($\Sigma\text{input} - \Sigma\text{output} = 5.869$ t N y⁻¹) was not closed and the excess was not explained by the mere removal in the canal network, much lower. This was likely due to an underestimate of denitrification in soils, calculated by using coefficients taken from literature. This observation is also supported by the results of field and laboratory experiments, performed in the same soils, which indicate higher rates of denitrification (Mastrocicco et al., 2011; 2012). Regardless of, the secondary canals' network has evidenced a potential to effectively mitigate the excess of nutrients from diffuse sources of pollution, particularly in summer when the eutrophication risk is at highest. Simulations performed in this study highlight the importance of conservative management of emergent vegetation, in order to improve nitrogen removal in vulnerable watersheds.

References

- Isidoro D., Quilez D. and Aragues R. 2006. Environmental Impact of Irrigation in La Violada District (Spain): II. Nitrogen fertilization and nitrate export patterns in drainage water. *Journal of Environmental Quality* 35, 776-785.
- Kronvang B. and Bruhn A.J. 1996. Choice of sampling strategy and estimation method for calculating nitrogen and phosphorus transport in small lowland streams. *Hydrological Processes* 10 (11), 1483-1501.
- Letcher R.A., Jakeman A.J., Calfas M., Linforth S., Baginska B. and Lawrence I. 2002. A comparison of catchment water quality models and direct estimation techniques. *Environmental Modelling and Software* 17 (1), 77-85.
- Mastrocicco M., Colombani N., Salemi E. and Castaldelli G. 2011. Reactive modelling of denitrification in soils with natural and depleted organic matter. *Water Air and Soil Pollution* 222, 205-215.
- Mastrocicco M., Colombani N., Salemi E., Vincenzi F. and Castaldelli G. 2012. The role of the unsaturated zone in determining nitrate leaching to groundwater, In: Zuber A., Maloszewski P., Witzak S. and Malina G. (eds), *Groundwater Quality Sustainability*, IAH Book Series, Taylor & Francis Books (UK), in press.
- Oenema O., Kros H. and de Vries W. 2003. Approaches and uncertainties in nutrient budgets: implications for nutrient management and environmental policies, *European Journal of Agronomy* 20 (1-2), 3-16.
- Soana E., Racchetti E., Laini A., Bartoli M. and Viaroli P. 2011. Soil Budget, Net Export, and Potential Sinks of Nitrogen in the Lower Oglio River Watershed (Northern Italy). *CLEAN – Soil, Air, Water* 39 (11), 956-965.

Nitrogen mineralization potential of soil amended with biochar from pig-slurry solids

Marchetti, R.^a, Castelli, F.^b, Orsi, A.^a, Sghedoni, L.^a

^aAgricultural Research Council, Research unit for swine husbandry, San Cesario sul Panaro (MO), Italy

^bAgricultural Research Council, Bovolone Experimental Farm, Bovolone (VR), Italy

1. Background & Objectives

Interest in biochar (BC) has dramatically grown in recent years, due mainly to the fact that its incorporation into soil reportedly enhances carbon sequestration and fertility (Lehmann and Joseph, 2009). As large amounts of livestock manure solids are expected to become available in the near future, due to the development of technologies for the separation of the solid fraction of animal effluents (Burton, 2007), the processing of manure solids for BC production seems an interesting possibility for the recycling of OM of high nutrient value. The aim of this study was to estimate the nitrogen (N) mineralization potential (NMP) of soil amended with BC from pig-slurry solids. Wood chip, which is currently used as a raw source for BC production, was also included in the comparison as reference material. To test the hypothesis that BC can retain N when incorporated into soil we also applied fresh digestate (D) derived from a biogas plant to soil as a N source, and the BC×D interaction effect on soil NMP was evaluated.

2. Materials & Methods

Treatments compared were soil amended with pig-slurry solids (LC), charred pig-slurry solids (LT), wood chip (CC), charred wood chip (CT), and no amendment (control, C), each one with and without (\pm) incorporation of digestate (D); 10 treatments in total (Tab. 1). Biochar was obtained by treating dried wood chip or pig-slurry solids, with residual moisture content of 9% and 10%, respectively, at 420°C in anoxic conditions. Charred or non-charred OM was incorporated into a silty clay soil and the NMP was determined according to Drinkwater et al. (1996) during 3 months (at 0, 7, 14, 28, 60, and 90 d of incubation) at 30°C. For each measurement date the difference (Δ NMP) of inorganic N content (N-NH₄+N-NO₃) between the treated and the control soil is reported. The standard error of the differences of least-square means was used for the treatment effect comparisons. Factor effects were considered significant at $P < 0.05$.

Table 1. Organic C and Kjeldahl N contents in the amendments and in the digestate used for the experiment, and amounts supplied to soil. FW= weight of the OM used as it is (charred, non charred or D)

Type of amendment	Content		C/N	Amount supplied to soil		
	(g kg ⁻¹ FW)			(g FW kg ⁻¹ dry soil)		
	C	N		Amendment	C	N
Pig-slurry solids (LC)	482	18.2	27	5.61	2.70	0.102
BC from pig-slurry solids (LT)	511	21.1	24	4.82	2.46	0.102
Wood chip (CC)	432	6.2	70	6.26	2.70	0.039
BC from wood chip (CT)	720	10.8	67	3.42	2.46	0.037
Digestate (D)	16.8	3.1	5.4	32.8	0.56	0.102

3. Results & Discussion

Time courses of Δ NMP in soil after OM incorporation are reported in Figure 1. Without digestate addition (Figure 1a) in soil amended with non-charred OM (CC and LC treatments) Δ NMP decreased during the first two weeks of incubation. The Δ NMP values increased again to the control levels in the following two months, in LC, whereas in CC values remained significantly lower than in the control (after 90 d, 32.84 mg kg⁻¹, >S.E.= 4.64 mg kg⁻¹). In soil amended with charred OM (CT and LT treatments) only slight fluctuations of Δ NMP around 0 were detected (i.e. no changes

in comparison with the control). When digestate was added to soil (Figure 1b), in the first two weeks of incubation a greater decrease in ΔNMP in the DCC treatment than in the others was observed. Reasons could be attributed to N immobilization. Nitrogen immobilization is favored by high C to N ratios (Paul and Clark, 1996), and wood chip did have high C/N values (Table. 1). However, ΔNMP did not decrease in soil amended with charred wood-chip, although it had the same C to N ratio as the non-charred treatment. At the end of the second month of incubation ΔNMP was higher in soil amended with pig-slurry solids (either charred or non-charred). These higher values of LC and LT being associated uniquely with +D treatments, mineralization of the organic N supplied with digestate could have brought about the release of mineral N in the +D treatments. Although 3 months after the start of the incubation significant differences between treatments were no longer detectable (apart from CC±D), in the short run the supply of charred OM seems to have mitigated the mineralization-immobilization turnover (MIT) in soil during the incubation period, whereas the supply of digestate, together with charred or non-charred OM, seems to have increased it.

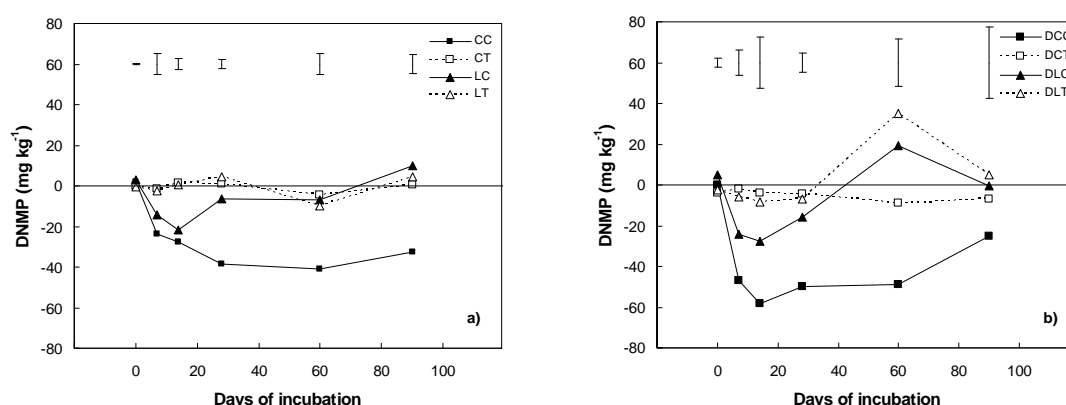

Figure 1. N mineralization potential in soil amended with charred or non-charred OM a) without supply of digestate; b) with supply of digestate. ΔNMP =inorganic N content in treated soil minus inorganic N content in the control soil. Vertical bars are the standard error of the mean.

4. Conclusion

The charring of OM affected the pattern of release of mineral N in soil in the short term, apparently reducing the MIT intensity, compared with that associated with non-charred OM. Nitrogen availability, clearly modified after soil amendment with non-charred OM, did not seem to be affected by incorporation of BC, either of plant or animal origin. Biochar incorporation did not reduce N availability in soil supplied with digestate, the pattern of interaction between soil amendments and digestate being instead influenced by the type of amendment.

Acknowledgements: This work was granted by MiPAAF within the framework of the project "Development of models for husbandry sustainability" (SOS ZOOT), MAREA sub-project.

References

- Lehmann J. and Joseph S. 2009. Biochar for environmental management: science and technology, Earthscan, London, GB.
- Burton C.H. 2007. The potential contribution of separation technologies to the management of livestock manure. *Livestock Science* 112, 208-216.
- Drinkwater L.E., Cambardella C.A., Reeder J.D. and Rice C.W. 1996. Potentially mineralizable nitrogen as an indicator of biologically active soil nitrogen, In: Doran J.W. and Jones A.J. (eds.), *Methods for assessing soil quality*, SSSA Spec. Publ. 49, Madison, WI, USA pp. 217-229.
- Paul E.A. and Clark F.E. 1996. *Soil Microbiology and Biochemistry* (2nd edition), Academic Press, San Diego, CA.

Nitrogen mineralization potentials in rice-wheat systems in southeastern China

Hofmeier, M.^a, Roelcke, M.^a, Yong, H.^b, Cai, Z.C.^c, Nieder, R.^a

^aInstitute of Geocology, TU Braunschweig, 38106 Braunschweig, Germany

^bInstitute of Soil Science, Chinese Academy of Sciences, Nanjing 210008, P.R. China

^cCollege of Geography Science, Nanjing Normal University, Nanjing 210046, P.R. China

1. Background & Objectives

The rice (*Oryza sativa* L.)-wheat (*Triticum aestivum* L.) double-cropping system in southeastern China is characterized by anaerobic conditions during the irrigated lowland summer rice crop and aerobic conditions during the upland winter wheat crop. However, the alternating water regime leads to high gaseous and leaching losses of nitrogen (N) mainly after the winter wheat crop due to flooding, puddling and ponding of the field for the summer rice crop (Roelcke et al., 2002). In order to minimize these losses, little residual mineral N (N_{\min}) should be present in the soil profile at wheat harvest. Mineral N fertilizer application needs to be optimized and adapted to the demand of the winter wheat crop. Therefore, a better understanding of the N transformation processes, including mineralization dynamics of organic N during the winter wheat cropping season is essential. Long-term aerobic incubation laboratory experiments were carried out with soils from two rice-wheat growing regions in southeastern China.

2. Materials & Methods

Aerobic long-term laboratory incubation experiments (182 days) were carried out with soils from rice-wheat double-crop rotations from two different locations in Jiangsu Province (Yixing (31°17' N 119°53'E) and Huai'an (33°30'N 119°03'E), based on the method by Stanford and Smith (1972), modified by Nordmeyer and Richter (1985). At each site, field-moist soil samples from three depth increments (0-20 cm, 20-60 cm, 60-90 cm) were taken after field preparation for the winter wheat crop. Samples were mixed with quartz sand, filled in 60 ml plastic syringes, incubated by 35 °C and regularly leached with a 0.01 M CaCl₂ solution on days 0, 3, 7, 14, 21, 35, 49, 70, 91, 119, 147 and 182 after the onset of the experiment. Mineral N (NO₃⁻-N and NH₄⁺-N) in the leachates was determined by continuous-flow analysis and the cumulative amounts were used for estimation of mineralization parameters using a double exponential model with two first-order kinetics reactions (Richter et al., 1982):

$$N(t) = N_a \times \{1 - e^{(-k_a \times t)}\} + N_r \times \{1 - e^{(-k_r \times t)}\} \quad [1]$$

The estimated parameters will subsequently be included in the HERMES model (Kersebaum, 1995; Kersebaum and Beblík, 2001) for simulation of the N dynamics in the soil, water and plant system during the winter wheat growing period. Calibration and validation of simulation results will be performed with field N_{\min} , gravimetric water contents, as well as plant N uptake data, taken from field experiments conducted in Yixing and Huai'an during three winter wheat cropping seasons (2008-2011).

3. Results & Discussion

Table 1. Properties of the soils used for the long-term incubation experiment.

Location	Depth [cm]	pH [H ₂ O]	CaCO ₃	C _{org}	N _{tot}	Sand*	Silt	Clay
					-----[%]-----			
Yixing	0-20	6.2	n.d.	1.7	0.20	0.7	82.9	16.4
	20-60	7.5	n.d.	0.4	0.05	1.6	84.5	13.9
	60-90	7.5	n.d.	0.2	0.05	2.0	86.0	12.0
Huai'an	0-20	8.3	8.3	1.8	0.26	1.8	53.5	44.8
	20-60	8.4	9.0	1.0	0.08	11.5	57.7	30.8
	60-90	8.4	7.4	0.8	0.07	0.8	65.7	33.4

* Sand: 2-0.063 mm; Silt: 0.063-0.002 mm; Clay: < 0.002 mm

Soil properties in Yixing and Huai'an are presented in Table 1. The soil in Yixing was developed in alluvial deposits and has a silty clay loam texture. The soils on the experimental sites in Huai'an are relatively young and developed in limnic sediments with high clay contents.

Figure 1 shows the cumulative N mineralization in three depth increments of the soils from Yixing and Huai'an. As expected, highest amounts of N were mineralized in 0-20 cm depth of the soils in both locations with a distinctly higher N mineralization in the topsoil of Huai'an. The 20-60 cm depth showed a drastically lower N mineralization for both soils, with slightly higher amounts in the soil from Huai'an. Almost no N mineralization occurred in the 60-90 cm soils depth of both locations.

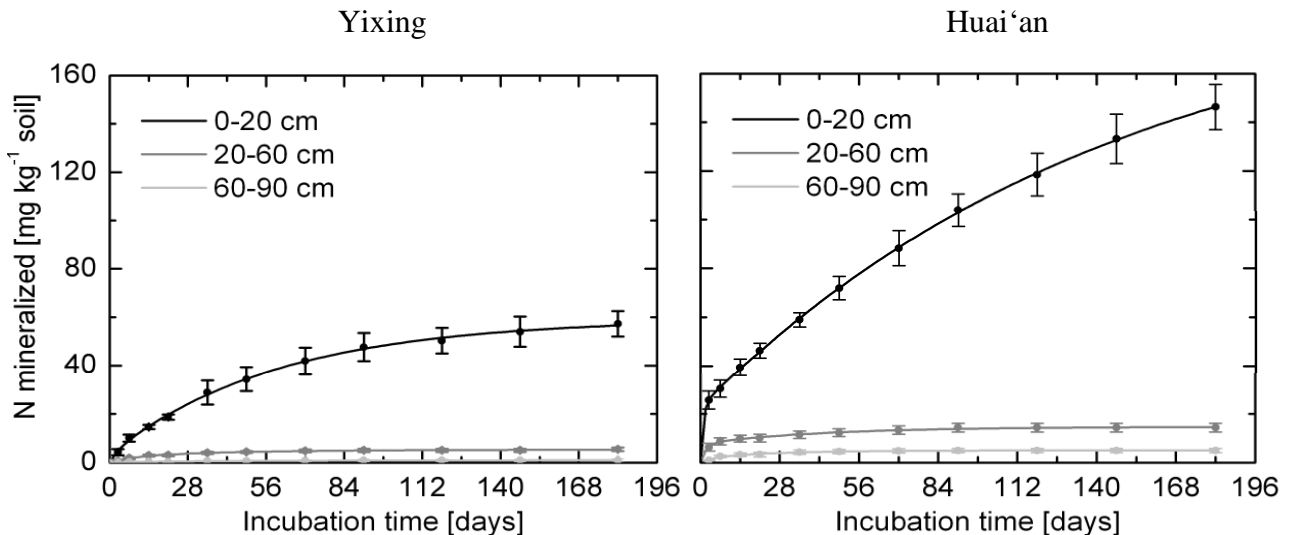

Figure 1. Cumulative N mineralization during 182 days in three depth increments (0-20 cm, 20-60 cm, 60-90 cm) of experimental soil from Yixing (left) and Huai'an (right), China; error bars represent s.d., n=4.

4. Conclusion

The experimental results showed a clearly higher N mineralization in the soils from Huai'an, which can be explained by higher soil organic matter and clay contents (Table 1). These differences have to be considered for N fertilization recommendations. The results will be used for parameter adaptation in the HERMES model and for simulation of the N dynamics during the winter wheat growing season in rice-wheat systems.

Acknowledgements

This research was funded by the Sino-German project "Nitrogen Management China", BMBF-FKZ: 0330800C, MOST grant no. 2007DFA30850.

References

- Kersebaum, K.C. 1995. Application of a simple management model to simulate water and nitrogen dynamics. In: *Ecological Modelling* 81, p. 145-156
- Kersebaum K.C. and Beblík A.J. 2001. Performance of a nitrogen dynamics model applied to evaluate agricultural management practices. In: Shaffer M., Ma L., Hansen S. (eds.) *Modeling carbon and nitrogen dynamics for soil management*. Lewis Publishers, Boca Raton, USA, pp 549-569
- Nordmeyer, H. and Richter, J. 1985. Incubation experiments on nitrogen mineralization in loess and sandy soils. In: *Plant Soil* 39, 433-445.
- Richter, J., Nuske, A., Habenicht, W. and Bauer A. 1982. Optimized N-mineralization parameters of Löss-soils from incubation experiments. In: *Plant Soil* 68, 375-388.
- Roelcke, M., Han, Y., Cai, Z.C. and Richter, J. 2002. Nitrogen mineralization in paddy soils of the Chinese Taihu Region under aerobic conditions. In: *Nutr. Cyc. Agroecosyst.* 63, 255-266.
- Stanford, G. and Smith, S. J. 1972: Nitrogen mineralization potentials of soils. In: *Soil Sci. Soc. Am. Proc.* 36, 465-472.

Nitrogen removal by fruits, leaves and pruning wood in a peach orchard

Villar, J.M.^a, Pascual, M.^a, Fonseca, F.^b, Lordan, J.^{a,b}, Villar, L.^a, Arbones, A.^b, Rufat, J.^b

^a Universitat de Lleida (UdL), ETSEA, Av Rovira Roure 191, 25198 Lleida, Spain

^b Institut de Recerca i Tecnologia Agroalimentàries, IRTA, Av Rovira Roure 191, 25198 Lleida, Spain

1. Background & Objectives

Peach nitrogen fertilization could be optimized considering the diversity of agronomic practices. Application rates range between 100-170 kg N ha⁻¹. Nitrogen uptake and distribution has been studied in young nectarine trees (Tagliavini et al., 1999) and, for a mature peach orchard with 500-700 tree/ha, Tagliavini et al (1996) calculated an annual removal of nitrogen of 109-157 kg N ha⁻¹ (leaves contribution was estimated). The objective of this paper was to evaluate the effects of fertilisation on annual N removal of nitrogen in fruit, leaves and pruning wood, from a mature peach orchard, on a shallow calcareous soil with high soil organic matter content.

2. Materials & Methods

A five-year field experiment (2006–2010) on clingstone peach (*Prunus persica* (L.) Batsch cv. Andross), grafted on GF305 rootstock (5x2.8 m; 715 trees ha⁻¹) was conducted in a commercial orchard under mechanical harvesting for the processing industry. A 3x3 factorial design with randomized complete blocks and four repetitions was established. Three nitrogen doses were evaluated: 0, 60 and 120 kg N ha⁻¹, combined with three drip irrigation treatments: full irrigation throughout the growing season; restricted irrigation during stage-II (70% restriction) and restricted irrigation during stage-III (30% restriction). N content in the irrigation water was negligible. The soil type was a shallow, well-drained, loam which had a petrocalcic horizon within 45 cm of the soil surface (Petrocalcic Calcixerepts). The soil had a pH of 8.4, and 2.5-3% organic matter (OM). Trees were fertigated (N32 solution) on a daily basis. Soil was sampled to determine nitrate content (2 cores inside the wet volume). Fruit (endocarp and mesocarp), leaf and pruning wood dry matter were measured and analysed for N to estimate total N removal. Apparent nitrogen recovery (ANR) was the additional N uptake per unit of added nutrient (kg kg⁻¹) and was calculated as described by Greenwood and Draycott (1989). The effect of N treatment on N removal by fruit, leaves and pruning wood corresponds to 2009 (fourth experimental year). Statistical analysis of data was carried out using the SAS-STAT package (SAS®, Version 9.2.)

3. Results & Discussion

Tree N removal has been higher than the applied N (Table 1). Full irrigation treatment (4270 m³ ha⁻¹ until harvest) combined with N60 achieved the highest yield (data not shown). N fertilisation increased the annual removal of N as it was demonstrated by Rufat and DeJong (2001). This irrigated mature orchard removed a high amount of nitrogen (total N removal ranged between 136 and 189 kg N ha⁻¹). The roots and the permanent framework (trunk and branches) were not included. Average N removal by endocarp was 15% of the total fruit (ranged from 12 to 18%). Leaves and pruning wood showed a similar amount of N removal. In this farm, the pruning wood is chopped and left on the soil surface. Average N recovery was 76.4 % for N60 treatment and 47.8% for N120 treatment (Table 2). These ANR were very high due to fertigation practice. N taken up by the N0 treatment trees comes from OM mineralization and from the initial soil NO₃-N content (4.3 mg kg⁻¹). Initial soil nitrate content was not different between treatments. Table 3 shows how the soil NO₃-N content (0-35 cm) inside the wet bulb at the end of stage-II increased with N application.

Table 1. Effect of N treatments on annual removal of N by a mature peach tree (year 2009)

Concept	Units	N0	N 60	N120
Total fresh fruit yield	kg ha ⁻¹	39,829	45,154	43,614
Total dry matter fruit yield	kg ha ⁻¹	4,028	3,960	4,310
Endocarp yield	kg ha ⁻¹	3,145	2,915	3,450
Mesocarp yield	kg ha ⁻¹	883	1,044	860
Endocarp N concentration	%	0.460	0.518	0.523
Mesocarp N concentration	%	0.675	0.842	0.928
Endocarp removal	kg N ha ⁻¹	4.1	5.4	4.5
Mesocarp removal	kg N ha ⁻¹	21.2	24.6	32
Total N removal by yield (fruits)	kg N ha ⁻¹	25.3	30.0	36.5
Pruning wood yield	kg ha ⁻¹	5,300	7,275	6,675
Pruning wood N concentration	%	1.398	1.665	1.673
Total N removal by pruning wood	kg N ha ⁻¹	52.9	86.5	79.7
Leaves dry matter	kg ha ⁻¹	2,014	1,980	2,155
Leaf N concentration	%	2.85	3.14	3.40
Total N removal by leaves	kg N ha ⁻¹	57.4	62.2	73.3
Total N uptake*	kg N ha ⁻¹	135.6	178.7	189.5

* Permanent framework (trunk and branches, and roots) are not included

Table 2. N recovery related to N doses (%)

Treatment	N uptake* (N0)	N uptake* (kg N ha ⁻¹)	N applied (kg N ha ⁻¹)	ANR (%)
N60	135.6	178.7	56.4	76.4
N120	135.6	189.5	112.7	47.8

* Permanent framework (trunk and branches, and roots) are not included

Table 3. Soil NO₃-N content at the end of stage-II (LS Means differences, Tukey HSD, $\alpha=0.05$)

Treatment	Soil NO ₃ -N content (mg kg ⁻¹)
N0	6.87 b
N60	21.17 a
N120	23.50 a

4. Conclusions

The application of N fertiliser throughout fertigation to peach orchards increased on average between 32-40% the total annual removal of N. N0 treatment showed an important amount of N uptake, being the soil organic matter mineralization and the leaves and pruning wood decomposition the main N sources. Highest fertilizer recovery was achieved for N60 treatment and this amount would be advisable to farmers. Any N application is not advisable when irrigation and nitrogen are properly applied.

References

- Greenwood D.J. and Draycott A. 1989. Experimental validation of an N-response model for widely different crops. *Fertil Res* 18, 153-174.
- Rufat J. and DeJong T.M. 2001. Estimating seasonal nitrogen dynamics in peach trees in response to nitrogen availability. *Tree Physiol.* 21 (15):1133-1140.
- Tagliavini, M., Scudellari D., Marangoni B. and Toselli M. 1996. Nitrogen fertilization management in orchards to reconcile productivity and environmental aspects. *Fertilizer Research* 43, 93-102.
- Tagliavini M., Millard P., Quartieri M. and Marangoni B. 1999. Timing of nitrogen uptake affects winter storage and spring remobilisation of nitrogen in nectarine (*Prunus persica* var. *nectarina*) trees. *Plant and Soil* 211(2), 149-153.

Nitrogen sources and sinks in a heavily impacted watershed (Oglio River, Northern Italy)

Laini, A.^a, Sacchi, E.^b, Soana, E.^a, Delconte, C.A.^b, Racchetti, E.^a, Bartoli, M.^a and Viaroli, P.^a

^aDepartment of Environmental Sciences, University of Parma, Viale G.P. Usberti 33/A, 43124 Parma, Italy

^bCNR-IGG, U.O.S. Pavia and Department of Earth and Environmental Sciences, University of Pavia, via Ferrata 1, 27100 Pavia, Italy

1. Background & Objectives

Increased reactive nitrogen (N) input to the biosphere by human activities has resulted in the gradual saturation of the N buffering capacity of terrestrial areas and increased N loads to aquatic ecosystems. Farming activity is one of the primary causes for the current high N loads, due to unbalanced livestock manure production and agricultural lands availability for spreading. The control of N inputs to aquatic systems is of general public interest due to ecosystemic consequences as eutrophication and the potential nitrite toxicity. Rivers are particularly critical because they link terrestrial and coastal ecosystems, and aggregate stressors occurring at the landscape scale. Worldwide N budgets suggest that up to 75% of the N load generated within catchments is retained and not exported via river discharge. N retention is the result of several processes, among which some are well studied (i.e., crop uptake) while others are scarcely investigated (i.e. denitrification in lotic ecosystems, N storage in soils, percolation and N transformations in groundwater) and represent large, unknown terms in N budgets. The aim of this study is to provide a detailed analysis of N budget and pathways in a river basin with a large N surplus, and in particular to explore the fate of the N pool retained within the watershed.

2. Materials & Methods

The study was conducted on the Oglio River and watershed, (156 km river stretch and 3,800 km² watershed area), located within the Po basin, northern Italy. Agricultural nitrogen balances were performed for the year 2008 using the “soil system budget” approach (Oenema et al. 2003). Farming census data were used to compare N input (livestock manure, synthetic fertilizers, atmospheric deposition, biological fixation and wastewater sludge) and output (crop uptake, ammonia volatilization and denitrification in soils) within the catchment’s agricultural land. Industrial and domestic inputs were also calculated using census data from National Statistics Institution. The watershed N export was estimated from monthly measurements (years 2000 to 2008) at the Oglio River closing section; here water flow and dissolved and particulate N forms are regularly monitored by the Oglio Consortium and by the Regional Agency for the Environment. Denitrification was measured in riverine wetlands by means of the isotope pairing technique (Nielsen, 1992) and in the river course using a dual isotopic approach (Silva et al., 2000). Theoretical denitrification rates in the secondary drainage system were estimated according to Soana et al. (2011). Lowland springs (n=30) were sampled bimonthly from December 2010 to October 2011; water samples were collected and analysed in the laboratory for nitrate NO₃⁻, nitrite NO₂⁻ and nitrous oxide N₂O concentrations via spectrophotometry and gas chromatography.

3. Results and Discussion

The N mass balance suggests a large N surplus in this area, with livestock manure and synthetic fertilizers contributing 85% of total N inputs from agriculture (about 100 kt N yr⁻¹) and largely exceeding crop uptake, soil denitrification and volatilization (about 60 kt N yr⁻¹). Nitrogen from domestic and industrial origin is relatively small, contributing 5.8 and 7.2 kt N yr⁻¹, respectively. Annual export of N from the watershed is about 13 kt N yr⁻¹, resulting in a large excess unaccounted (~40 kt N yr⁻¹) for in unknown temporary or permanent N sinks.

The watershed out flow had enriched nitrate stable isotope composition but calculations suggest a N removal corresponding to at most ~ 3 kt N yr⁻¹. Although denitrification rates in wetlands are high they result in low N removal (<1% of the missing N amount) due to their small surface area and limited lateral connectivity.

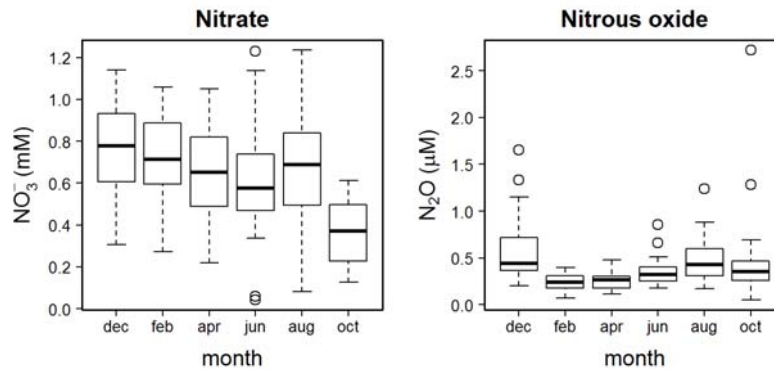

Figure 1. Nitrate and nitrous oxide concentrations in lowland springs.

The secondary drainage channel network, with a linear development of over 12,500 km, has a much higher potential for nitrogen removal via denitrification, estimated in up to 8.5 kt N yr⁻¹ (Soana et al., 2011). Overall, denitrification in surface aquatic habitats within this basin can be responsible for the permanent removal of about 12 kt N yr⁻¹; but the fate of the remaining 28 kt is unknown. We suggest that in this basin groundwater N accumulation and transformation could be an important N sink. In fact, nitrate and nitrous oxide concentrations in springs were high in all sampling campaigns (Figure 1). Nitrate was often above the national value for drinking water (~ 11.2 mg N/L) while nitrous oxide was constantly supersaturated. Significant correlation between nitrous oxide and nitrate were not found, stressing the complexity of the interaction between water pathways and nitrogen cycle in the subsurface.

4. Conclusions

A soil system nitrogen budget realized in the Oglio River watershed suggests that net export of this nutrient at the basin closing section represents a minor fraction of the large unbalance between sources and sinks. We provide evidences that groundwater represents a large, temporary site of N accumulation in this basin, that recycles N to the surface via springs and via river-groundwater interactions. Further research should address groundwater N transformations, transfer between surface and deep groundwater and estimate of the time required by groundwater to recover from nitrate pollution if N loads are significantly reduced in the future.

References

- Nielsen L.P. 1992. Denitrification in sediment determined from nitrogen isotope pairing, FEMS (Federation of European Microbiological Societies) Microbiology Ecology 86, 357-362.
- Oenema O., Kros H. and De Vries W. 2003. Approaches and Uncertainties in Nutrient Budgets: Implications for Nutrient Management and Environmental Policies, European Journal of Agronomy, 20 (1-2), 3-16.
- Silva S.R., Kendall C., Wilkison D.H., Ziegler A.C., Chang C.C.Y. and Avanzino R.J. 2000. A new method for collection of nitrate from fresh water and the analysis of nitrogen and oxygen isotope ratios, Journal of Hydrology 228, 22-36.
- Soana E., Racchetti E., Laini A., Bartoli M. and Viaroli P. 2011. Soil budget, net export and potential sinks of nitrogen in the lower Oglio River watershed (northern Italy), CLEAN- Soil, Air, Water 39(11), 956-965.

Nitrous oxide emission from biogas production systems on a coastal marsh soil

Techow A.¹, Dittert K.², Senbayram M.², Quakernack R.³, Pacholski A.³, Kage H.³, Taube F.¹, Herrmann A.

Christian-Albrechts-University of Kiel, D-24118 Kiel

1 Institute of Crop Science and Plant Breeding; Grass and Forage Science/Organic Agriculture

2 Institute of Plant Nutrition and Soil Science

3 Institute of Crop Science and Plant Breeding; Agronomy and Crop Science

1. Background & Objectives

The marsh regions in northern Germany are characterised by specific soil and climatic conditions (relatively high precipitation and wind speed, moderate temperature, high ground water level, clay-rich soils with high water saturation, and low oxygen supply), which bear the risk of high denitrification under intensive N fertilisation. However, the nitrous oxide (N₂O) emissions potential of marsh sites has been poorly studied (Jungkunst et al., 2006). As in many other regions throughout Germany, biogas production has expanded substantially in recent years, resulting in high amounts of biogas residues which have to be recycled. The objective of the current study therefore was to (i) quantify the N₂O emissions from grassland, and from two cropping sequences of maize-winter wheat and wheat-Italian ryegrass for a typical marsh site, and (ii) to analyse the impact of fertiliser type (biogas residue vs. mineral fertiliser) and N rate (control, optimal, oversupply; N amount dependent on crop) on N₂O emissions.

2. Materials & Methods

Nitrous oxide emission was monitored from April to December 2009 and from March 2010 to March 2011 on a heavy clay soil (25-30% clay, Fluvimollic Gleysol, pH 7.5) close to the west coast of Schleswig-Holstein, Germany. The measurements were embedded in an ongoing field experiment that was established in 2007 as a randomised complete block design with 4 replicates, where the impact of feedstock production systems for biogas (grassland, maize monoculture, maize-winter wheat-Italian ryegrass), type of N fertiliser (calcium ammonium nitrate (CAN), biogas residue), and N rate (control, optimal, oversupply; N amount dependent on crop) on yield performance and environmental effects (N₂O and NH₃ emissions) was tested. Measurement of N₂O emissions was restricted to the control and oversupply treatments in grassland, and the sequences of maize-winter wheat and wheat-Italian ryegrass. Corresponding N rates were 480 kg N ha⁻¹ for grassland, 240 kg N ha⁻¹ for winter wheat, 200 kg N ha⁻¹ for maize, and 80 kg N ha⁻¹ in Italian ryegrass, split in one to four dressings. Biogas residue was applied by trail hoses. Nitrous oxide emissions were monitored daily after fertiliser applications with successive expansion of the sampling intervals up to one week, using the closed chamber method. The N₂O concentrations were determined with a gas chromatograph (Varian). Data on N₂O emission were analysed statistically by SAS Proc Mixed and multiple comparisons were conducted by the Tukey-Kramer-Test.

3. Results & Discussion

In the first experimental year N₂O flux pattern mostly followed the fertilisation events in all crops. Consistently, elevated N₂O flux rates were detectable for one to two weeks after fertilisation. Freeze/thaw events apparently had no effect.

Cumulative N₂O emissions in 2009 (Table 1) were characterised by a rather low level compared to other studies (Van Groenigen et al., 2004; Dittert et al., 2009), while the measurements in 2010 resulted in higher N₂O emissions. It seems likely that this finding is attributable to low soil moisture conditions during spring and early summer of 2009, which are known to have a great influence on

N₂O emissions. Senbayram et al. (2009), for instance, found 5-fold higher fluxes at 85% than 65% water holding capacity, and effects of fertiliser type (CAN vs. biogas residue) were significant only at high soil moisture. In accordance, soil moisture content and N₂O emissions were higher in 2010.

Table 1. Cumulative N₂O emission (kg N₂O-N ha⁻¹) monitored from April to December 2009 and from March 2010 to March 2011 for different crops and fertiliser treatments. Maize denotes the maize-winter wheat cropping sequence, while wheat represents the wheat(*)-Italian ryegrass sequence; (*summer wheat in 2009, since unfavourable conditions in autumn 2008 prevented sowing of winter wheat).

	Crop/Fertiliser treatment	Grassland	Maize	Wheat	Mean
2009	Control	0.22	0.93	0.21	0.45a
	Mineral N (CAN)	2.00	1.15	2.43	1.86b
	Biogas residue	1.74	1.18	1.49	1.47b
2010/ 2011	Control	1.42	4.42	3.39	3.08a
	Mineral N (CAN)	5.31	5.63	4.60	5.18b
	Biogas residue	6.24	5.37	3.43	5.01ab

Statistical analysis of the cumulative N₂O emission of 2009 revealed a significant effect of the fertiliser treatment ($p = 0.002$). While no difference was detected between CAN and biogas residue application, both treatments gave higher emission than the control. In 2010, only the mineral N treatment showed significantly higher emissions than the control, although the difference to the biogas residue treatment was marginal. Contrary to our expectations, the crop species caused no significant differences in N₂O emissions, whereas Dittert et al. (2009) reported 20 to 30 % higher N₂O fluxes for maize compared to a whole crop wheat-grass sequence, which was attributed to the later onset of soil water consumption by transpiration and of later mineral N uptake in maize. Own measurements, however, showed similar soil moisture content in the 0-10 cm layer among the tested crops, whereas ground water level showed considerable spatial and temporal fluctuation. Overall, the cumulative N₂O emissions were well below expectations, probably also due to a low N₂/N₂O ratio, which is currently being investigated by means of an incubation study.

4. Conclusion

Our hypotheses stating that biogas substrate production on a coastal marsh soil will cause high N₂O emissions was not confirmed which most likely was due to soil and climatic conditions. A more comprehensive analysis, taking all N flows into account and supplemented by simulation models, is planned for the future and will provide more detailed insights into the underlying processes.

References

- Dittert K., Senbayram M., Wienforth B., Kage H. and Mühling K.H. 2009. Greenhouse gas emissions in biogas production systems. UC Davis: The Proceedings of the International Plant Nutrition Colloquium XVI. <http://www.escholarship.org/uc/item/18p5q83f> (March 2010).
- Jungkunst H.F., Freibauer A., Neufeldt H. and Bareth G. 2006. Nitrous oxide emissions from agricultural land use in Germany - a synthesis of available annual field data. *Journal of Plant Nutrition and Soil Science* 169, 341-351.
- Senbayram M., Chen R., Mühling K.H. and Dittert K. 2009. Contribution of nitrification and denitrification to nitrous oxide emissions from soils after application of biogas waste and other fertilizers. *Rapid Communications in Mass Spectrometry* 23, 2489-2498.
- Van Groenigen J.W., Kasper G.J., Velthof G.L., Van den Pol-van Dasselaar A. and Kuikman P.J. 2004. Nitrous oxide emissions from silage maize fields under different mineral nitrogen fertilizer and slurry applications. *Plant and Soil* 263, 101-111.

Nitrous oxide emissions during the decomposition of summer cover crop residue under no-tillGiacomini, S.J.^a, Weiler, D.A.^a, Bastos, L.M.^a, Dietrich, G.^a, Schmatz, R.^a, Aita, C.^a^a Department of Soil Science, Federal University of Santa Maria, Santa Maria, RS, Brazil.**1. Background & Objectives**

Some species of legumes, known as summer cover crops (SCC), have satisfactory biomass and N accumulation in a short period of time e.g., between the harvest of summer crops and sowing of winter crops (Creamer and Baldwin, 2000). In Southern Brazil, SCC legumes grown in no-till can be an important source of N for the following winter crops, reducing the cost associated with N fertilizers. However, the addition of N and C with the SCC residues in the soil can increase the emission of N₂O to the atmosphere (Baggs et al., 2000). Thus, it is necessary to evaluate the SCC in order to select those species that combine high dry matter (DM) and N addition with low potential to promote N₂O emissions. Therefore, the objective of this study was to investigate the temporal patterns and total N₂O emissions during decomposition of the SCC residues in no-till with oats.

2. Materials & Methods

The experiment was conducted from January to September 2010 on a Typic Hapludalf (60% sand, 30% silt, 10% clay, total C 7.5 g kg⁻¹) at the Department of Soil, Federal University of Santa Maria (29°41'S, 53°48'W), Brazil. The treatments were six SCC: velvet-bean (*Mucuna aterrima*), pearl millet (*Pennisetum americanum*), pigeon pea (*Cajanus cajan*), sunn hemp (*Crotalaria juncea*), crotalaria spectabilis (*Crotalaria spectabilis*), jack bean (*Canavalia ensiformis*) and two fallow plots kept for comparative purposes. Randomized complete block design having four replications and a plot size of 50m² was used. The SCC were sown in late January and killed with knife rollers at flowering stage in mid-April (80 days of cultivation). After the SCC were killed we carried out direct seeding of oat winter crop in all plots of the experiment. All the plots were fertilized with phosphorus and potassium. However, urea-N (60 kg ha⁻¹) was applied only in one of the two fallow plots. Soil N₂O fluxes were measured from April to September after the SCC were killed until the oats reached physiological maturity using static chambers method. The N₂O concentrations in the samples were analyzed by gas chromatography (Shimadzu GC-2014 Greenhouse). Daily N₂O fluxes (µg N m⁻² h⁻¹) were calculated by linear interpolation and the cumulative fluxes (g N ha⁻¹) were calculated by the integration of the daily N₂O emissions.

1. Results & Discussion

SCC with only 80 days of cultivation showed DM and N accumulation that ranged from 5.1 to 14.0 Mg ha⁻¹ and 100 to 211 kg ha⁻¹, respectively (Table 1). These results demonstrated the ability of SCC to accumulate high amounts of DM and N in a short period of time in Southern Brazil.

Table 1. DM and N added by SCC, total N₂O emissions and emission factors by N applied and SCC DM addition.

Treatments	DM (Mg ha ⁻¹)	N added (kg ha ⁻¹)	N ₂ O (g ha ⁻¹)	N ₂ O (% N applied)	N ₂ O (g N Mg ⁻¹ DM)
Velvet-bean	5.1	104	886 ab	0.70 a	173.0 a
Pearl millet	14.0	133	685 bcd	0.40 b	48.5 d
Pigeon pea	4.1	100	511 cd	0.35 b	124.0 bc
Sunn hemp	8.4	136	757 abc	0.44 ab	89.9 c
Crotalaria	8.4	186	987 a	0.44 ab	117.0 bc
Jack bean	5.8	211	824 ab	0.31 b	141.1 ab
Fallow*	-	-	160 e	-	-
Fallow +Urea-N	-	-	453 de	0.49 ab	-

*The fallow plots were kept without plants growing. Values with the same letters do not significantly differ (P < 0.05).

The N_2O flux after the SCC residues addition to soil ranged from -1.5 to $1,017 \mu\text{g N m}^{-2} \text{h}^{-1}$ (Figure 1). The largest flows of N_2O were observed in the first 40 days after the SCC were managed. During this period, the increase in N_2O fluxes coincided with the occurrence of rainfall events which resulted in the elevation of water-filled pore space (WFPS), which favored the anaerobic reduction of NO_3^- . The largest emissions of N_2O were observed 9 days after SCC were managed in velvet bean plots. After 40 days of SCC management, even with the rainfall that caused an increase in WFPS, we observed no increase in the flow of N_2O (Figure 1). These results indicated that during this period the lack of NO_3^- and C limited the activity of facultative anaerobic microorganisms. The cumulative N_2O emissions in the SCC treatments exceeded that observed in fallow and ranged from 511 to 987 g N ha^{-1} , corresponding to 0.31-0.70% of the N applied with SCC (Table 1). The percentage of synthetic N fertilizer applied in the oat crop that was emitted as N_2O was similar to that observed for the treatments with SCC. The range of emission factors is slightly lower than the emissions predicted by the IPCC (2006) default emission factor of 1% of N applied. The N_2O flows and cumulative emissions were not related to the amount of N added with SCC. It is possible that other characteristics of SCC residues, such as polyphenol, also interfere in the N_2O emission. The difference in the addition of DM and C among species may also explain this result. The lowest emission factor, considering the amount of N_2O emitted per Mg of biomass added by the SCC was observed in the poaceae pearl millet (Table 1). Among the legumes, the highest and lowest emission factor were observed in velvet-bean and sunn hemp plots, respectively.

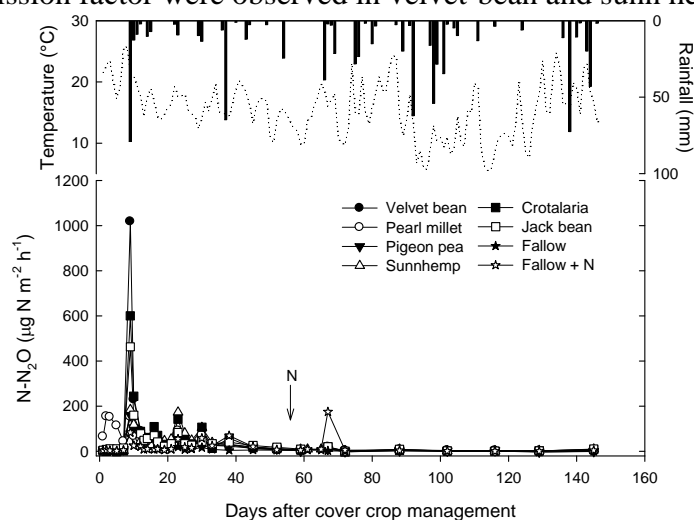

Figure 1. Rainfall, temperature and N_2O emissions after SCC were managed.

4. Conclusion

This study indicated that among the legumes grown as SCC, sunn hemp fulfilled the requirements of satisfactory N and DM addition to soil with lower N_2O emission potential under no-till.

References

- Creamer N.G. and Baldwin K.R. 2000. An evaluation of summer cover crops for use in vegetable production systems in North Carolina. *HortScience* 35, 600-603.
- Baggs E.M., Rees R.M., Smith K.A. and Vinten A.J.A. 2000. Nitrous oxide emission from soils after incorporating crop residues. *Soil Use Manage* 16, 82-87.
- IPCC (Intergovernmental Panel on Climate Change). 2006. In: Eggleston H. S., Buendia L., Miwa K., Ngara T., Tanabe K. (Eds.), *Guidelines for National Greenhouse gas Inventories*, vol. 4, Agriculture, Forestry and Other Land Use. National Greenhouse gas Inventories Programme.

Nitrous oxide emissions from a clay soil after mouldboard ploughing or tine cultivation

Stenberg, M.^a, Kasimir Klemedtsson, Å.^b, Nylinder, J.^b, Weslien, P.^c, Myrbeck, Å.^d, Wetterlind, J.^a, Rütting, T.^c, Klemedtsson, L.^c

^aSLU, Dept. of soil and environment, Precision agriculture and pedometrics, PO Box 234, SE-532 23 Skara, Sweden

^bUniversity of Gothenburg, Dept. of earth sciences, PO Box 460, SE-405 30 Göteborg, Sweden

^cUniversity of Gothenburg, Dept. of plant and environmental sciences, PO Box 461, SE-405 30 Göteborg, Sweden

^dSLU, Dept. of soil and environment, Soil and water management, PO Box 7014, SE-750 07 Uppsala, Sweden

1. Background & Objectives

When calculating nitrogen (N) balances for clay soils, substantial amounts of N are found missing; found neither in crops nor leaching losses. In these cases, losses by gaseous emissions can be suspected. Therefore, knowledge of a magnitude of nitrous oxide (N₂O) emissions from Swedish clay soils is needed and also possible ways of mitigating these emissions by altering farming practice. Tillage is a management practice that may significantly influence emission rates both in the long and the short term. Depending on conditions ploughing may enhance mineralisation or deteriorate soil structure, influencing emissions. Reduced tillage may result in accumulation of N in the soil surface, which is also an emission source. Soil tillage under wet conditions can have negative effects on the soil structure, especially on clay soils (Myrbeck et al., 2012). While Wetterlind et al. (2005) found different degrees of mineral N accumulation in the soil profile between 0-90 depth; dry autumns had higher accumulation than wet. These could explain gaseous N losses from the soil in wet years as well as leaching losses. In this study we compare effects of early autumn ploughing with late ploughing as well as tine cultivation on emissions of N₂O at the site described by Myrbeck et al. (2012).

2. Materials & Methods

Lanna experimental farm is situated in south-west Sweden (lat. 58 21'N, long. 13 08'E) on a large agricultural plain. The soil was classified as an Udic Haploboroll (USDA) (Bergström et al., 1994). The clay content increases with depth, 45% in 0-30 cm, 57% in 60-90 cm and 58% in the 60-90 cm layer. Top soil pH (H₂O) is 6.8. Organic carbon content is 3.4% in the top-soil and 0.6% and 0.0% in the sub-soil layers. The 1961-1990 average annual precipitation was 560 mm and annual temperature 6.1°C (Alexandersson and Eggertsson Karlström, 2001). Normally the soil is frozen during parts of the winter. The drains usually flow from November to April and for longer in some years (Larsson and Jarvis, 1999). The soil is normally unsaturated to a depth of 2.2 m and this zone is characterized by numerous cracks and biotic macro-pores.

Emissions of N₂O from 3 tillage treatments; mouldboard ploughing to 20 cm depth early in September, mouldboard ploughing in November and tine cultivation to 10 cm depth twice in September, replicated in 3 blocks (9 plots in total) were determined in 3 chambers per plot by the static chamber method at the long-term soil tillage field experiment in autumn 2009 and spring 2010. A cereal crop rotation of spring sown wheat-barley-oat was grown during the experimental period and crop residues were left in the field and incorporated by tillage in all treatments. Grain yields from the crop were recorded from the start of the field experiment in 1997, described by Myrbeck et al. (2012). Soil physical characteristics in the treatments were reported by Myrbeck as well. The project continued until 2011 with measurements in chambers, in addition to a micrometeorological technique (Klemedtsson et al., 1997). Measurements in chambers were carried out at and between tillage operations during autumn, by measurements during 1 hour in 3 consecutive days at each occasion. The micrometeorological measurements were carried out

continuously. The project was financed by The Swedish Farmers' Foundation for Agricultural Research.

3. Results & Discussion

The N₂O emissions were low overall and not significantly different between the tillage practices, however tine cultivation tended to give the highest emissions (Figure 1). Cumulative and average emissions were calculated for September to October, the period between early and late ploughing. Cumulative emissions were 0.05 kg N₂O-N ha⁻¹ for early ploughing, 0.03 for late and 0.48 for tine cultivation, but were not significantly different due to large variation (SD 0.05, 0.04 and 0.66 resp.).

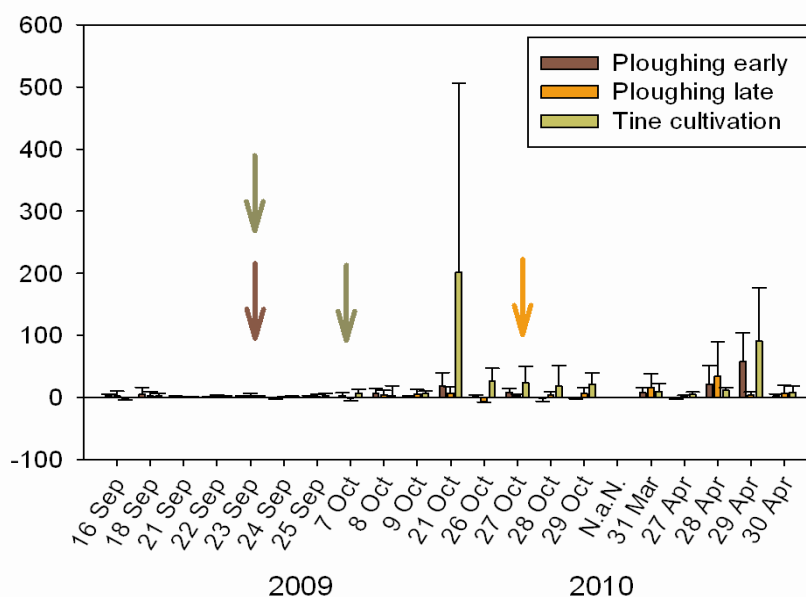

Figure 1. N₂O emissions at measurements during autumn 2009 to spring 2010. Tillage operations represented by arrows were carried out on 23rd September, 7th and 27th October.

4. Conclusion

The N₂O emissions measured during the first year of the study were small and not influenced by timing of ploughing. Reduced tillage tended to give higher emissions during the first year, but not significantly different. The missing N losses were not due to N₂O emissions.

References

- Alexandersson, H. and Eggertsson Karlström, C. 2001. Temperaturen och nederbörden i Sverige 1961-1990. Referensnormaler - utgåva 2. Meteorologi no. 99. SMHI, Norrköping. 71 pp. (in Swedish).
- Bergström, L., Jarvis, N.J. and Stenström, J. 1994. Pesticide leaching data to validate simulation models for registration purposes. *J Environ Sc. Health A* 29, 1073-1104.
- Klemedtsson, L., Klemedtsson, Å.K., Moldan, F. and Weslien, P. 1997. Nitrous oxide emission from Swedish forest soils in relation to liming and simulated increased N-deposition. *Biology and Fertility of Soils* 25, 290-295.
- Larsson, M.H. and Jarvis, N.J. 1999. Evaluation of a dual-porosity model to predict field scale solute transport in a macroporous soil. *Journal Hydrology* 215, 153-171.
- Myrbeck, Å., Stenberg, M., Arvidsson, J. and Rydberg, T. 2012. Effects of autumn tillage of clay soil on mineral N content, spring cereal yield and soil structure over time. *European Journal of Agronomy* 37, 96-104.
- Wetterlind, J., Stenberg, B., Lindén, B. and Stenberg, M. 2006. Tidig höstplöjning på lerjordar - riskbedömning av kväveutlakning. SLU, Skara. Avd. för precisionsodling. Rapport 6. (in Swedish).

Nitrous oxide emissions from grassland treated with different types of manure: comparison between slurry plus fertilizer plots and farmyard manure plus fertilizer plots

Mori, A.^a, Hojito, M.^b

^aNARO Institute of Livestock and Grassland Science, Nasushiobara, Tochigi 329-2793, Japan

^bField Science Center, School of Veterinary Medicine, Kitasato University, Towada, Aomori 034-8628, Japan.

1. Background & Objectives

In Japan, approximately 660 Gg of nitrogen (N) is excreted from livestock annually, of which approximately 430 Gg is composted before application to agricultural soil. On the main island of Japan, bark or sawdust is often applied to dairy cattle excreta during the composting process to promote aerobic fermentation. As a result, the rate of N mineralization from compost after application to grassland is slower than that from fresh manure because of the persistence of organic materials in the manure. The objective of the present study is to compare the annual nitrous oxide emissions from slurry plus fertilizer plots and those from composted farmyard manure (FYM) plus fertilizer plots.

2. Materials & Methods

A field study was performed on a grassland plot located at the NARO Institute of Livestock and Grassland Science in Nasu, Japan (latitude 36°55'N, longitude 139°55'E, 320 m a.s.l.). The soil was previously classified as an Entic Haplumbrepts, loamy, mixed, mesic. The dominant plant species was orchardgrass (*Dactylis glomerata* L.). In March 2008, 9 plots (4 × 4 m) with no N fertilizer (–N plots), slurry plus N fertilizer (slurry plots) and composted FYM plus N fertilizer (FYM plots) were installed in blocks of three for each treatment in a randomized block design experiment.

Dairy slurries and sawdust-containing dairy FYMs were obtained just before each application from two commercial farms and used for this field experiment. The application rates of slurry and FYM to plots were determined based on their potassium (K) contents with the aim that the annual K supply from these organic amendments covered the annual K requirements of plots. Phosphorous (P) fertilizer was supplemented so that annual P supply from these organic amendments and fertilizer covered the annual P requirements of plots. The application rates of ammonium sulphate were determined so that the annual N supplies from slurry plus fertilizer or FYM plus fertilizer covered the annual N requirements of plots (Table 1). From March 2008 to March 2010, N₂O fluxes were determined using cylindrical stainless steel chambers (40 cm in diameter, 30 cm in height). Flux measurements were basically conducted 1, 3, 7, 10 and 14 days after fertilization and 1–4 weeks intervals after the initial 14 days. Air samples were collected from each chamber at 0 and 30 minutes after the chambers were set up. Concentrations of N₂O were determined by using a gas chromatograph equipped with a gas chromatograph equipped with an electron capture detector. The N₂O fluxes were calculated from the linear increase in N₂O concentration. The cumulative N₂O emissions were calculated by means of trapezoidal integration of the areas under the N₂O flux curve.

Table 1 Mineral N supply from mineral fertilizer, slurry and FYM (kg ha⁻¹ year⁻¹)

Plot	N type	First year (From 22 March 2008 to 21 March 2009)						Second year (From 22 March 2009 to 21 March 2010)					
		25 March	28 May	10 July	1 September	Mineral N supply from slurry [†] or FYM [‡]	Total	26 March	28 May	13 July	1 September	Mineral N supply from slurry [†] or FYM [‡]	Total
–N	Fertilizer	-	-	-	-	-	0	-	-	-	-	-	0
Slurry	Slurry	(150) [§]	(150) [§]	-	-	120	210	(150) [§]	(150) [§]	-	-	120	210
	Fertilizer	-	-	60	30	-	-	-	-	60	30	-	-
FYM	FYM	(252) [§]	-	-	-	33	210	(252) [§]	-	-	-	51	210
	Fertilizer	40	47	60	30	-	-	29	40	60	30	-	-

[†]Mineral N supply from slurry was estimated to be 40% in the applied year (Hokkaido Prefectural Experiment Stations and Hokkaido Animal Research Center, 2004).

[‡]Mineral N supplies from FYM were estimated to be 13.4% in the applied year and 7.0% in the following year (Shiga et al., 1985).

[§]Actual amounts of N in the applied slurry or FYM were shown in parentheses.

3. Results & Discussion

Fluxes of N_2O from $-\text{N}$, slurry and FYM plots ranged from 4 to 17, from 5 to 228, and from 2 to 268 $\text{g N ha}^{-1} \text{ day}^{-1}$, respectively. The heights and widths of N_2O flux peaks were greater in the first year than in the second year (Figure 1).

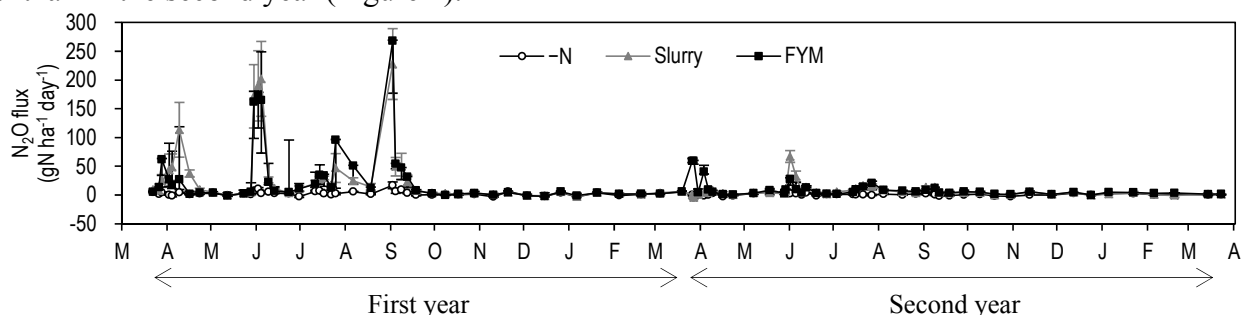

Figure 1. Seasonal change of nitrous oxide flux

The annual N_2O emissions from $-\text{N}$, slurry and FYM plots ranged from 0.35 to 0.81, from 1.8 to 7.6, and from 2.2 to 7.6 $\text{kg N ha}^{-1} \text{ year}^{-1}$, respectively (Table 2). The annual N_2O emission from slurry plots was not significantly different from that from FYM plots. Emission factors of N_2O were 0.36% to 1.7% for slurry plots and 0.46% to 1.6% for FYM plots.

Table 2 Annual N_2O emissions from grassland plots

	Plot	First year [†]	Second year [‡]
N_2O emission ($\text{kg N ha}^{-1} \text{ year}^{-1}$)	$-\text{N}$	0.81 ± 0.33	0.35 ± 0.11
	Slurry	7.6 ± 4.0	1.8 ± 0.4
	FYM	7.6 ± 5.5	2.2 ± 0.2

[†]From 22 March 2008 to 21 March 2009.

[‡]From 22 March 2009 to 21 March 2010.

Values are means \pm standard errors ($n = 3$).

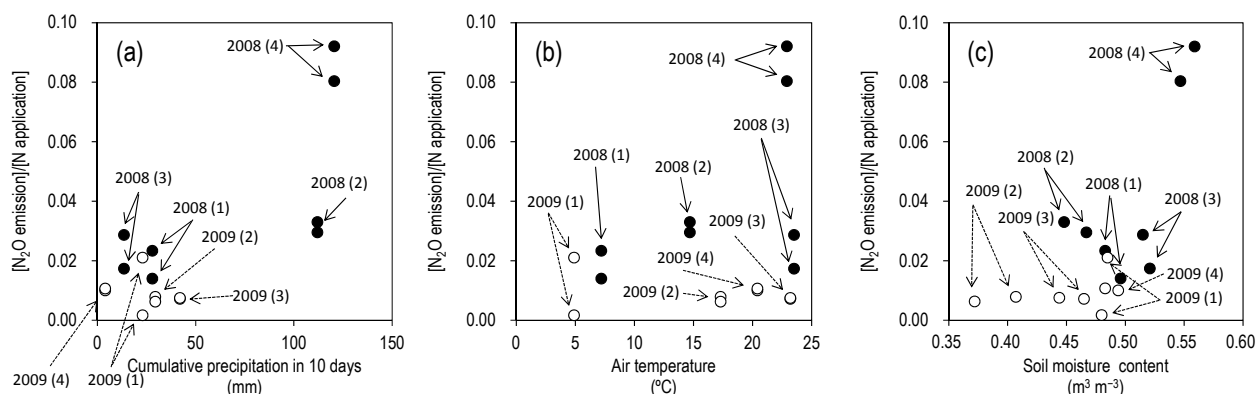

Figure 2. Factors controlling the ratio of [cumulative N_2O emission induced by N application]/[N application] in each grass-growing period; (a) cumulative precipitation in 10 days after N application, (b) air temperature and (c) soil moisture content at a times of N application

The ratio of [cumulative N_2O emission induced by N application]/[N application] in each grass-growing period was greater with greater precipitation just after N application (Figure 2a), higher air temperature (Figure 2b) and greater soil moisture (Figure 2c) at the time of N application.

4. Conclusion

The annual N_2O emissions from slurry plus fertilizer plots were of similar magnitude to those from FYM plus fertilizer plots. The seasonal and interannual differences in the ratio of [N $_2$ O emission induced by N application]/[N application] in each grass-growing period were due to differences in precipitation after N application, air temperature and soil moisture status at times of N application. However, no significant difference was observed between slurry plus fertilizer plots and FYM plus fertilizer plots.

Nitrous oxide emissions from two maize crop seasons in northwestern Spain

Louro, A., Báez, D., García, M.I., Castro, J.

INGACAL-Centro de Investigaciones Agrarias de Mabegondo (CIAM). Apartado 10, 15080. A Coruña, Spain.

1. Background & Objectives

Nitrogen (N) additions to cropland soils are the largest source of anthropogenic nitrous oxide (N₂O) emissions and are an important contributor to global greenhouse gas radiative forcing. Regional estimates of fertilizer contributions to N₂O emissions often utilize the IPCC methodology, which assumes that 1% of all N inputs are lost as N₂O. However, due to the limited data available to provide an emission factor, it does not account for differences between crop type, soil, climate. Further research is needed to determine the impact of best management practices on N₂O emissions. The aim of this study was to determine the effect of type of fertilizer applied to obtain N₂O emissions from forage maize under the influence of humid-temperate climate typical of northwestern Spain and provide the resulting emission factors for the duration of the crop season.

2. Materials & Methods

The experiment was carried out on two different sites located within at the experimental farm of CIAM (43°N latitude, 8°W longitude, 94 m altitude), during two growing seasons of *Zea mays* L. (site 1: May-October 2008 and site 2: May-September 2009) on a silt loam soil. The mean annual temperature in the study area is 16.8 °C and the mean annual rainfall 1088 mm (10 years average). Experimental plots using a randomized block design with three replicates and four treatments were established in both years. The treatments were as follow: (1) no N application or control (C), (2) mineral fertilizer (M), (3) cattle slurry (CS) and (4) pig slurry (PS). A rate of 200 kg N ha⁻¹ was applied in each fertilizer treatment: entirely distributed just before sowing in (CS) and (PS), and 125 kg N ha⁻¹ in sowing and 75 kg N ha⁻¹ for the top dressing in (M). Within each plot two closed chambers were placed (diameter: 25 cm; height: 36 cm; depth into the soil: 3 cm) to monitor N₂O fluxes. Samples were collected in *vacutainers* 45-90 minutes after chamber enclosure and analyzed by a gas chromatography with an electron capture detector. In addition, soil samples, for the measurements of moisture as Water Filled Pore Space (WFPS) and mineral N, and meteorological station data were taken to see the influence of weather and soil properties on N₂O fluxes.

3. Results & Discussion

Both sites show (Figure 1) the first emissions peaks 20-30 days after fertilization events and rainfall. Emissions were higher under N fertilizer application than without N fertilizer but no significant effect of type of N fertilizer was observed from seeding to top dressing in M and from top dressing to harvesting in both sites (Table 1). Cumulative N₂O fluxes in the first site were 40-50% higher than the second one. This difference could be due to soil moisture content. In site 2 we found low correlations between N₂O emissions and WFPS ($p < 0.01$), soil N-NH₄⁺ ($p < 0.01$) and N-N-NO₃⁻ concentrations ($p < 0.01$). Soil N-NO₃⁻ was correlated with N-NH₄⁺ ($P < 0.01$) and soil temperature at 10 cm depth ($p < 0.01$) This means that even though nitrate levels and soil temperature were adequate to observe higher N₂O emissions, the high soil moisture content (average 97% WFPS) caused by rainfall would possibly have decrease the aerobic status of the soil, resulting in lower N₂O:N₂ ratios as products of the denitrification process (de Klein and van Logtestijn, 1996). The site 1 was the beginning of this study so that limited soil sampling carried out in N fertilized plots do not allow for correlations between moisture and mineral N. However it seems that values of WFPS between 60-90% (average 61%) and mineral N in soil were favorable for the N₂O emission by denitrification. The resulting emission factors in both cropping seasons and

in all treatment studied were equal to 1.80, 2.15, 1.82% of the amount of N applied in site 1, and 1.81, 1.39, 1.44% in site 2 for M, CS and PS, respectively. Our values were in relationship with the EF reported in Rochette et al. (2004) in soils planted to maize and fertilized at a rate of 200 kg N ha⁻¹. Mineral fertilizer plots had the same EF in both sites while slurry treatments showed higher EFs in site 1 under favourable conditions for denitrification, increasing the risk of N₂O emissions due to the easily available C for the denitrifying bacteria (Barton and Shipper, 2001).

Table 1. Average cumulative N₂O-N emission ± standard deviation of the treatments studied in both experimental sites. Period 1: From seeding to the day before of the top dressing in M. Period 2: From the top dressing to the harvesting. C: Control; M: Mineral fertilizer; CS: Cattle slurry; PS: Pig slurry.

	Period 1		Period 2		Total	
	Site 1	Site 2	Site 1	Site 2	Site 1	Site 2
C	8.1±0.48 ^a	4.22±1.19 ^a	8.08±1.76 ^a	3.85±0.44 ^a	16.15±1.43 ^b	8.07±1.16 ^b
M	9.9±1.11 ^b	6.46±1.06 ^b	9.86±2.02 ^a	5.24±0.73 ^b	19.75±1.47 ^a	11.70±1.77 ^a
CS	10.5±1.08 ^b	5.76±0.60 ^b	10.04±2.13 ^a	5.16±1.05 ^b	20.52±1.30 ^a	10.91±0.90 ^a
PS	9.8±0.77 ^b	5.48±0.37 ^a	10.04±1.38 ^a	5.27±0.35 ^b	19.80±0.62 ^a	10.75±0.44 ^a

Treatments followed by the same letter do not differ at p<0.05

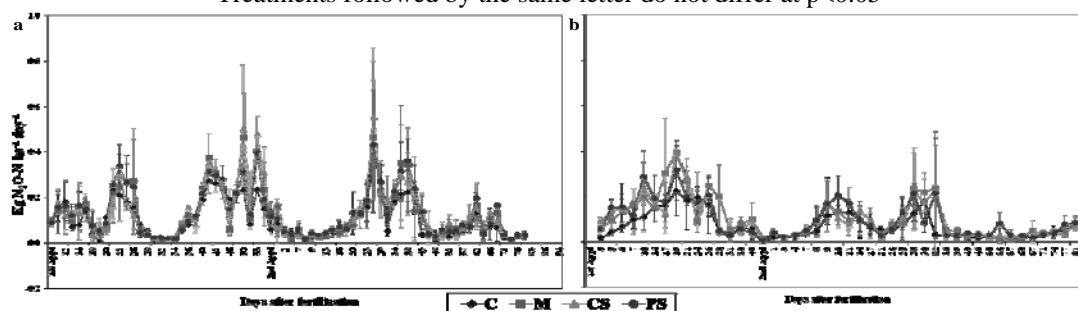

Figure 1. Nitrous oxide emission rates during the growing season of maize forage in sites 1 (a) and 2 (b). C: Control, M: Mineral fertilizer, CS: Cattle slurry, PS: Pig slurry. Data represent means and standard deviation for emission rates (n: 3).

4. Conclusion

Our results suggest that in our climate conditions the use of pig and cattle slurries had the same impact on N₂O emissions in comparison with a mineral fertilization. Soil moisture content was the main factor in the difference of the N₂O emissions between sites. Emissions factors of the N fertilized treatments studied in both crop seasons were significantly higher than the reference IPCC value of 1%, especially when climatic and soil conditions were appropriate for the denitrification.

References

- Barton L. and Shipper L.A. 2001. Regulation of nitrous oxide emissions from soils irrigated with dairy farm effluent, *Journal of Environmental Quality* 30, 1881-1887.
- IPCC, 2006. 2006 IPCC Guidelines for National Greenhouse Gas Inventories. Prepared by the National Greenhouse Inventories Programme, Eggleston H.S., Buendia L., Mika K., Ngara T. And Tanabe K. (eds), Published: IGES, Japan.
- de Klein C.A.M. and van Logtestijn R.S.P. 1996. Denitrification in grassland soils in Netherlands in relation to irrigation, N-application rate, soil water content and soil temperature, *Soil Biology Biochemistry* 28 (2), 231-237.
- Rochette P., Angers D.A., Chantigny, M.H., Bertrand N. and Coté D., 2004. Carbon dioxide and nitrous oxide emissions following fall and spring applications of pig slurry to an agricultural soil, *Soil Society of America* 68, 1410-1420.

Optimising the spring N fertilisation rate to winter oilseed rape

Engström, L.

Precision Agriculture and Pedometrics, Department of Soil and Environment, Swedish University of Agricultural Sciences, PO Box 234, SE-532 23 Skara, Sweden

1. Background & Objectives

Field experiments in Sweden show that with higher nitrogen (N) fertilisation rates at sowing of winter oilseed rape (*Brassica napus* L.) the spring N rate can be reduced without any yield loss. This suggests a negative relationship between N uptake in late autumn and the spring optimum N rate, which German field experiments have confirmed (Henke et al., 2009). Optimising the spring N-rate to winter oilseed rape will reduce the costs and also the risk for N leaching in the following crop, often winter wheat (Engström et al., 2011). In this ongoing study we investigate the influence of four different factors on economic optimum N rate in spring: N uptake in autumn, N uptake in spring, plant available soil N from spring to after flowering and yield level. The aim is to improve current N fertilisation recommendations to winter oilseed rape, which are mainly based on yield level at present.

2. Materials & Methods

Six field experiments, at six sites with contrasting cropping and N-input history (slurry or turkey manure application), were performed during 2010/2011 and another six are being performed during 2011/2012 in the south of Sweden. Six treatment plots (3 m x 15 m each) with increasing spring N rates (0-220 kg N ha⁻¹) were fully randomized, with four replicates (in total 24 plots) and placed in the farmers fields of winter oilseed rape. The mineral N fertiliser (50 % of each ammonium and nitrate) was applied at the beginning of growth in March-April. Yield was determined by combine-harvesting a 20-25 m² area of each plot. Plant N uptake was determined in late autumn, early spring and just after flowering (in unfertilised plots) by analyzing crop samples cut in 1 m² of each plot. Plant available soil N from early spring to after flowering (June) was calculated by subtracting N uptake in early spring from N uptake after flowering. Economical optimum N fertilisation was determined as the N rate at the highest net income, assuming a seed price of 3.3 Swedish kronor kg⁻¹, N cost of 9 Swedish kronor kg⁻¹ and cost for transport and drying 0.2 Swedish kronor kg⁻¹. Single and multiple regressions were conducted to ascertain how the four factors could explain the variation of the optimum N rate. In this paper data from the first six field experiments are presented.

3. Results & Discussion

N uptake at all six sites varied between 5 and 104 kg N ha⁻¹ in late autumn, and between 3 and 77 kg N ha⁻¹ in spring. Plant available soil N from spring to after flowering was 20-40 kg N ha⁻¹ with cereal and grass leys as preceding crops, and 60-80 kg N ha⁻¹ with peas and at sites with manure applied before sowing. Yields ranged from 980 to 4200 in unfertilised plots and from 3140 to 4700 at optimum N rate. The yield response to N fertilisation in spring was the highest at sites with low yields in unfertilised plots and the lowest at sites with high yields (Figure 1). Yield level in unfertilised plots correlated negatively (significantly, $p < 0.05$) to optimum N rate in spring ($R = 0.93$) probably reflecting soil N availability at the site. There was a significant negative correlation between optimum N rate in spring and N uptake in late autumn ($R = 0.74$) and also with yield at optimum ($R = 0.74$). The correlation was not significant between optimum N rate in spring and N uptake in spring or plant available soil N from spring to after flowering. According to the multiple regression analysis, optimum N rate in spring was best explained by N uptake in late autumn and

plant available soil N from spring to flowering R^2 (adj) = 0.98 or N uptake in spring and plant available soil N from spring to flowering R^2 (adj) = 0.84.

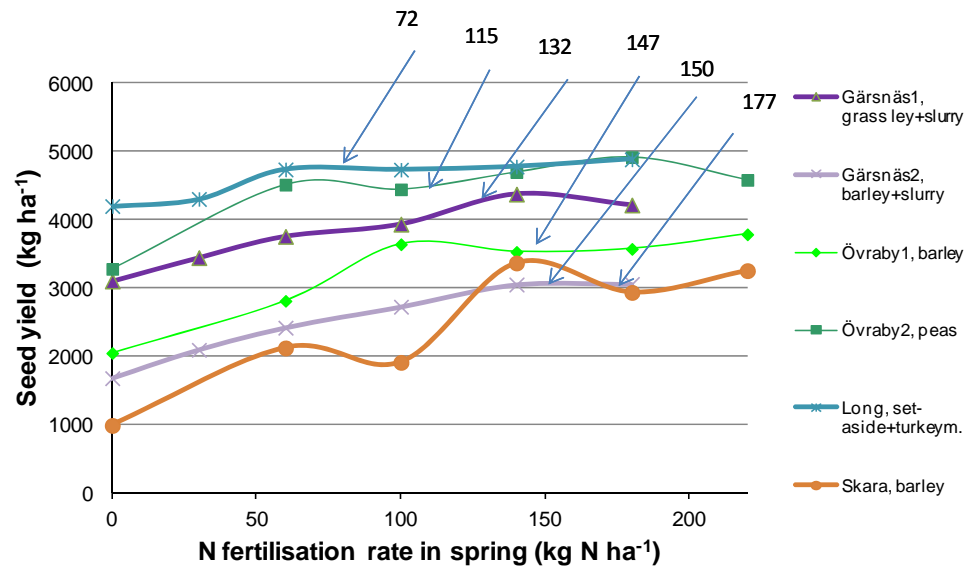

Figure 1. Yield response (9% water content) to spring N fertilisation and optimum N rate (by arrows) in six field experiments (Gärsnäs 1-2, Övraby 1-2, Long and Skara) with different preceding crops (grass ley, barley, peas, set aside land) and manure application (slurry and turkey manure) before sowing of winter oilseed rape (n= 4).

4. Conclusion

Highest net income was achieved with winter oilseed rape after peas or when fertilised with farm yard manure before sowing. At these sites yields were the highest and optimum N rate the lowest. The results suggest that N uptake in autumn or spring and plant available soil N from spring to flowering could be used to estimate optimum N rate in spring.

References

- Engström, L., Stenberg, M., Aronsson, H. and Lindén, B. 2011. Reducing nitrate leaching after winter oilseed rape and peas in mild and cold winters. *Agronomy for Sustainable Development* 31, 337-347.
- Henke, J., Sieling, K., Sauermann, W. and Kage, H. 2009. Analysing soil and canopy factors affecting optimum nitrogen fertilization rates of oilseed rape (*Brassica napus*). *Journal of Agricultural Science* 147, 1-8.

Physicochemical changes and nitrogen losses during composting of *Acacia longifolia* and *Acacia melanoxylon*

Brito, L.M., Mourão, I.

Mountain Research Center (CIMO), Instituto Politécnico de Viana do Castelo, Escola Superior Agrária, Refóios, 4990-706 Ponte de Lima, Portugal.

1. Background & Objectives

Acacias are invasive Fabaceae species and a serious threat to local biodiversity and natural habitats. Taking into account their high availability and low cost, a valorisation approach for acacia shrubs may be composting to produce horticultural organic amendments and substrate components. Acacias have large recalcitrant lignin, polyphenol and cellulose contents (Baggie et al., 2004) that do not contribute to raise composting temperatures. However, they are also rich in N whereas other conditions, including particle size, pile dimension and turning frequency (Brito et al., 2008) affect heat loss and pile temperature. The objectives of this work were to investigate the physicochemical characteristics and to model the breakdown of OM and N losses during composting of ground and screened acacia shrubs with different pile turning frequency, and to find out if composting acacia may reach high enough temperatures for compost sanitation and weed seed destruction.

2. Materials & Methods

Acacia longifolia and *Acacia melanoxylon* shrubs (particles <40 mm) collected in Portugal (at 40°25' N 8°44' W) were composted in big piles (100 m³) with higher (A) and lower (B) turning frequency. Temperatures were monitored automatically with thermistors positioned at 0.5, 1.5 and 2.5 m high and recorded by a data logger. Physicochemical characteristics were periodically determined by European standard procedures. OM and N losses were calculated from the initial and final ash and N contents according to the formulas of Paredes et al. (2000). Mineralization of OM during composting, determined by the OM lost, was described by the following two component kinetic model (adapted from the N mineralization model of Molina et al. (1980)):

$$OM_m = OM_1(1 - e^{-k_1t}) + OM_2(1 - e^{-k_2t}) \quad [1]$$

Where OM_1 and OM_2 are pools of mineralisable OM (OM_m), k_1 and k_2 the respective rates of mineralization (day^{-1}), and t the time (days). Data referring to OM losses during composting was fitted to the kinetic equation by the non-linear least-square curve-fitting technique (Marquardt–Levenberg algorithm). The same procedure followed for OM was carried out to describe N losses.

3. Results & Discussion

Time-temperature conditions in acacia piles exceeded the more stringent criteria for complete pathogen inactivation proposed by Wu and Smith (1999) equivalent to 55°C for ≥ 15 days, as temperatures were kept between 65°C and 75°C for >6 months, indicating high total amount of biodegradable OM in the composting material. As a consequence of the degradation of organic acids and ammonia production, the pH increased early during the process and thereafter was in the range 7.0-7.6. Organic matter mineralization (640-690 g kg⁻¹ of the initial OM, after 231 days of composting), showed two different phases of OM degradation (Figure 1). The first was indicative of the rapid decomposition of the readily biodegradable substrates and a high rate of microbial activity. The second phase showed a slower rate of OM degradation when only the more resistant compounds remained. The rates of mineralization were increased with increased turning frequency.

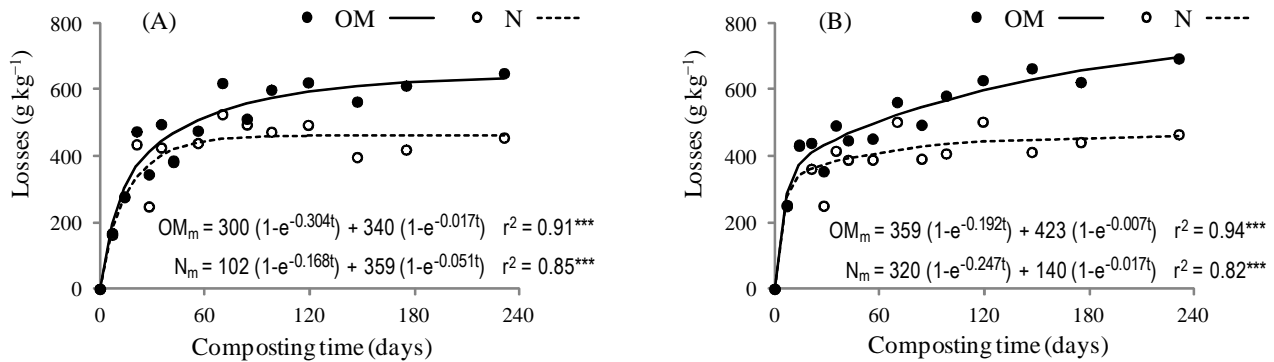

Figure 1. Organic matter (OM) and nitrogen (N) losses (g kg^{-1}) of composting acacia material with higher (A) and lower (B) turning frequency. *** ($P < 0.001$)

Total N content increased from initial values of 9.5 g kg^{-1} DM to final values of $11.5\text{--}12.3 \text{ g kg}^{-1}$ DM. An increase in total N content during composting has been widely reported (de Bertoldi and Civilini, 2006; Brito et al., 2008), and is due to a lower rate of N loss than OM loss. As expected, NO_3^- -N content in composting piles (data not shown) was negligible because the bacteria responsible for nitrification are strongly inhibited by temperatures greater than $40 \text{ }^\circ\text{C}$. This implies that the risk of N leaching was insignificant during this composting period. However, high temperature and high pH conditions during the thermophilic stage probably promoted intense ammonia emission, which would explain high N losses (460 g kg^{-1} of the initial N) found during acacia composting (Figure 1), mostly at the initial phase of the process when OM degradation and ammonia production was at its most rapid. Differences in N losses between piles were not significant. The C/N ratio declined from 50 at the beginning of composting to final values of 29–32 showing a higher OM mineralization compared to N volatilization (de Bertoldi and Civilini, 2006). The low electrical conductivity ($<1.3 \text{ dS m}^{-1}$) together with high OM and N contents in acacia composts suggests that they are suitable as organic soil amendments for agricultural land.

4. Conclusion

This work highlights that ground and screened acacia shrubs have sufficient biodegradability and structure to allow effective composting with increased OM losses compared to N losses.

Acknowledgements

This work was supported by the QREN/COMPETE/CEI_13584 project, funded by the EU.

References

- Baggie, I., Rowell, D.L., Robinson, J.S. and Warren, G.P. 2004. Decomposition and phosphorus release from organic residues as affected by residue quality and added inorganic phosphorus. *Agroforestry Systems* 63, 125-131.
- Brito, L.M., Coutinho, J. and Smith, S.R. 2008. Methods to improve the composting process of the solid fraction of dairy cattle slurry. *Bioresource Technology* 99, 8955-8960.
- de Bertoldi, M. and Civilini, M. 2006. High rate composting with innovative process control. *Compost Science and Utilization* 14, 290-295.
- Molina, J.A.E., Clapp, C.E. and Larson, W.E. 1980. Potentially mineralizable nitrogen in soil: The simple exponential model does not apply for the first 12 weeks of incubation. *Soil Science Society of America Journal* 44, 442-443.
- Paredes, C., Roig, A., Bernal, M.P., Sánchez-Monedero, M.A. and Cegarra, J. 2000. Evolution of organic matter and nitrogen during co-composting of olive mill wastewater with solid organic wastes. *Biology and Fertility of Soils* 20, 222-227.
- Wu, N. and Smith, J.E. 1999. Reducing pathogen and vector attraction for biosolids. *Biocycle* 40(11), 59-61.

Polyphenol and cellulose act as a nitrification inhibitor by different mechanisms

Sabahi, H., Rezayan, A.H.

Department of Life Science Engineering, Faculty of New Science and Technology, University of Tehran, Iran

1. Background & Objectives

Contamination of ground and surface water resources by nitrate (NO_3^-) is a major environmental concern around the world. Most of the NO_3^- in ground and surface water are derived from leaching or runoff from agricultural land, especially in winter. One of the measures that has been explored in arable cropping to increase the efficiency of N fertilizers, is to coat the fertilizer with nitrification inhibitors to slow down the conversion of protein (protein of microbial biomass) to NH_4^+ or NH_4^+ to NO_3^- . As part of our research program to develop suitable bio-nitrification inhibitors, here we wish to report new analysis of N mineralization of three N-fast release organic fertilizers.

2. Materials & Methods

Coarse and fine meals of three different legume seeds: yellow lupin (*Lupinus luteus* L.), blue lupin (*Lupinus angustifolius* L.) and faba bean (*Vicia faba* L.), were investigated. The fertilizers were mixed with 500g of wet soil (24% w/w) in each jar, in equivalent amounts, corresponding to 200 mg N kg^{-1} dry soil, (which is equal to about 130 kg N ha^{-1} incorporated into the uppermost 5 cm). The experiments were carried out in a randomized block design at 5°C in incubation chambers containing three layers for the placement of the jars corresponding to three blocks with regular changes in the positions within the blocks. On five occasions (5, 10, 17, 31 and 61 days after the start of the incubation), soil samples (40 g) were taken from each jar to determine mineral N, C and N in microbial biomass and total K_2SO_4 -extractable organic N (TON_{ext}).

3. Results & Discussion

To clarify the role of biochemical quality indicators in immobilization of nitrogen, the changes in N turnover during 61 days of incubation were investigated. The results showed that within days 10-17, the sum of increase in NH_4^+ plus NO_3^- and TON_{ext} was not equal to the decrease in microbial N, which indicated the net immobilization of nitrogen (Table 1). The results were similar for days 31-61. Net immobilization was greater in the fine size fractions than in the coarse size fractions. Fine size fractions of legume seed meals had lower content of lignin, cellulose, hemicellulose and C:N ratio but N amount and polyphenols were higher than in the coarse size fractions. As can be seen from Table 1, in the fine size fraction of yellow lupine, N microbial biomass has decreased by -36.8 mg.kg^{-1} while the sum of NH_4^+ , NO_3^- and TON_{ext} increased by 18.7 mg.kg^{-1} . Therefore, the difference (18.1 mg.kg^{-1}) may be because of binding of proteins to polyphenol intermediates. The

Table 1. Change in the soil nitrogen components during incubation (NO_3^- , NH_4^+ , microbial nitrogen and total K_2SO_4 -extractable organic N (TON_{ext})) from days 10 -17.

N components	Treatments						soil
	YL-fine*	YL-coarse	BL-fine	BL-coarse	FB-fine	FB-coarse	
	mg.kg^{-1}						
NH_4^+	11.5	43.1	8.5	24.9	3	34.7	1.1
NO_3^-	4.1	4.1	2.9	4.2	-9	-2.3	-1.1
Microbial N	-36.8**	-38.8	-50.7	-40.6	-69.2	-40.5	-11.7
TON_{ext}	3.1	-9.2	0.9	-3.8	24.5	-0.8	6
Sum of N changes***	-18.1	-0.9	-38.3	-15.3	-50.7	-8.9	-5.7

* YL= yellow lupin, BL= blue lupin, FB= faba bean.

** Negative values show a decrease in nitrogen amount during days 10-17.

*** Sum of N changes is equal to sum of NH_4^+ , NO_3^- , Microbial N and TON_{ext} .

correlation between polyphenol concentration and the sum of nitrogen changes was significant and positive ($r = 0.82$) which confirm this hypothesis. It is interesting to note that other researchers also reported that plant tissues contain considerable amounts of phenolic compounds which can bind to enzymes and other proteins by non-covalent forces, including hydrophobic, ionic and hydrogen bonds, causing protein precipitation (Palm and Sanchez, 1991; Quideau et al., 2011). Following our experiment, the changes in soil N components during incubation from days 17-31 were compared with the changes from days 10-17. The decrease in NH_4^+ and of the sum of N changes in the coarse sizes of the three seed meals were greater than with the fine sizes (Table 2). Between days 17-31, the increase in soil NO_3^- content was lower than the NH_4^+ decrease. This may be because of immobilization of NO_3^- during nitrification of NH_4^+ . Mineral N immobilization during this period was significantly correlated with the content of cellulose ($r = 0.83^*$), cellulose + lignin ($r = 0.84^*$), cellulose + hemicelluloses ($r = 0.91^*$) and lignin + cellulose + hemicelluloses ($r = 0.92^{**}$). While the pathways by which lignin and hemicelluloses help to immobilize NO_3^- on cellulose is not clear, nevertheless, the cell wall cellulose is covalently cross-linked to hemicellulose and lignin. Li et al. (2009) reported that N mineralization of lupin seed meals were negatively correlated with cellulose content ($r = 0.73$, $p = 0.05$) at 5°C , but that lignin and polyphenols had no effect on N mineralization due to their low content. Sabahi et al. (2009) have shown that accumulated N mineralization of legume seed meals at the end of an incubation experiment (61 days) significantly correlated with polyphenol and polyphenol:N ratio but not with cellulose. The effect of cellulose in N immobilization maybe short lived and unstable.

Table 2. Change in the soil nitrogen components during incubation (NO_3^- , NH_4^+ , microbial nitrogen and total K_2SO_4 -extractable organic N (TON_{ext})) from days 17-31.

N components	Treatments						soil
	YL-fine*	YL-coarse	BL-fine	BL-coarse	FB-fine	FB-coarse	
	mg.kg^{-1}						
NH_4^+	-9.8**	-30.3	-16.7	-26.5	-10.2	-33.8	-1
NO_3^-	-0.3	7.5	4.7	5.2	6.2	4.5	-1
Microbial N	-5.1	-10.4	11	4.5	26.7	17.7	17.4
TON_{ext}	11.7	18.9	5.2	6.1	-9.3	9.9	-3.7
Sum of N changes***	-3.5	-14.3	4.2	-10.7	13.4	-1.7	11.7

* YL= yellow lupin, BL= blue lupin, FB= faba bean.

** Negative values show a decrease in nitrogen content during days 17 to 31.

*** Sum of N changes is equal to sum of NH_4^+ , NO_3^- , Microbial N and TON_{ext} .

4. Conclusion

From the results of this experiment, it appears that in cold condition such as winter, polyphenols can act as a stronger nitrification inhibitor than cellulose, hemicellulose and lignin, especially if its concentration is sufficiently high.

References

- Li, Z., Schulz, R., Müller, T. 2009. Short-term nitrogen availability from lupin seed meal as an organic fertilizer is affected by seed quality at low temperatures. *Biological Agriculture and Horticulture*, 26, 337–352.
- Palm, C.A., Sanchez, P.A. 1991. Nitrogen release from the leaves of some tropical legumes as affected by their lignin and polyphenolic contents. *Soil Biology and Biochemistry*, 23, 83–88.
- Quideau, S., Deffieux, D., Douat-Casassus, D., Pouysgu, L. 2011. Plant polyphenols: chemical properties, biological activities, and synthesis. *Angewandte Chemie International Edition*, 50, 586 – 621.
- Sabahi, H., Schulz, R., Müller, T., Li Z. 2009. Nitrogen turnover of legume seed meals as affected by seed meal texture and quality at different temperatures. *Archives of Agronomy and Soil Science* 55, 6671- 682.

Potential for N₂O emissions from volcanic grassland soils

Cardenas, L.M.^a, Scholefield, D.^a, Hatch, D.J.^a, Jhurrea, D.^b, Clark, I.M.^b, Hirsch, P.R.^b, Salazar, F.^c, Rao-Ravella, S.^a and Alfaro, M.^c

^aRothamsted Research, North Wyke, Okehampton, Devon EX20 2SB, UK

^bRothamsted Research, Harpenden, Hertfordshire, AL5 2JQ, UK

^cInstituto de Investigaciones Agropecuarias (INIA Remehue), Casilla 24-0, Osorno, Chile

1. Background & Objectives

Grasslands are important ecosystems as they occupy large areas of the earth surface (about 40%, World Resources Institute, 2000). Their management involves a variety of practices affecting the soil physical structure, nutrient balance and the capacity of the soil to store C. Intensively managed grasslands have a major impact on water, soil and air quality. Nitrogen addition in the form of organic or inorganic fertiliser can cause losses to the environment, through leaching and to the atmosphere as nitrous oxide (N₂O) and carbon dioxide (CO₂), both greenhouse gases. Volcanic grassland soils in Chile, are not prone to leaching (Alfaro et al. 2008) and one of the possible pathways for N loss is N₂O emission. The objective of this study was to investigate the potential for the formation of N₂O of three Chilean soils and their relation to the presence of soil microbial communities.

2. Materials & Methods

Soils were two andisols and an ultisol (Osorno, Chiloé and Cudico respectively) collected in April 2007 and July 2008 from three grassland locations in the South of Chile. The soils pH was 5.8, 5.6 and 5.2 organic matter was 170, 270 and 140 g kg⁻¹; organic C was 9.9, 15.7 and 8.1 % for Osorno, Chiloé and Cudico respectively. The soils were air dried, sieved (2 mm) and mixed to be incubated for 15 days in aerobic conditions for the measurement of N₂O emissions (Carneiro et al., 2010). The soils (400 g dry soil) were compacted to a bulk density (BD) of about 1.2 (Cudico) and 0.64 g cm⁻³ (andisols) in Kilner jars with modified lids that incorporated a rubber septum for extracting gas samples. The following four treatments were superimposed: water only; water + N; water + C and water + N + C. N was applied as KNO₃ at a rate of 200 kg N ha⁻¹ (equivalent to 167 mg N kg soil⁻¹ for Cudico and 313 mg N kg soil⁻¹ for the andisols), based on the equivalent amount of soil occupying the 0-10 cm depth under field conditions. Three replicates were prepared for each soil and each treatment to give a total of 36 jars. C was applied as glucose at a rate of 600 kg C ha⁻¹ (equivalent to 500 mg C kg soil⁻¹ for Cudico and 938 mg C kg soil⁻¹ for the andisols). The final soil moisture content, after amendments were applied, was equivalent to 90% of the water holding capacity (WHC) or about 80% water filled pore space (WFPS) which created conditions conducive for denitrification. N₂O emissions were measured by gas chromatography daily for 8 days after the application of the amendment and then on days 11 and 15. Abundance of bacterial denitrification (*nirK*, *nirS*, *nosZ*) and 16S rRNA genes in the soils was determined by extracting DNA from each of three replicate samples of each soil before incubation and analysing in duplicate using qPCR.

3. Results & Discussion

Emissions of N₂O appeared in all soils in the N and N+C treatments about three days after the amendment application with cumulative fluxes for the whole incubation period of up to 20.9 mg N kg⁻¹ dry soil (see Table 1).

For each soil, there was no difference in the N₂O emissions between the two treatments (N and N+C) (P= 0.08; 0.48 and 0.31 for Chiloé, Cudico and Osorno, respectively). The interaction of soil with treatments was not significant (P> 0.05). The denitrifier communities in all soils appeared to

be dominated by *nirK* which was 50 to 100-fold more abundant than *nirS*. Osorno and Cudico soils contained similar numbers of *nirK* and *nosZ*, more than Chiloé, whereas Cudico had most and Chiloé fewest copies of *nirS* g⁻¹ dry soil (Figure 1). Bacterial 16S rRNA copy numbers were the same in all soils.

Table 1. Total N₂O fluxes from all soils and treatments in 15 days (mg N kg⁻¹ dry soil). Values in brackets are standard deviations of the mean of three replicates. All treatments had the same amount of water added

Treatment	N ₂ O, mg N kg ⁻¹ dry soil		
	Osorno	Chiloé	Cudico
Water	<1	<1	<1
C	<1	<1	<1
N	18.7 (1.75)	15.6 (0.39)	20.7 (1.37)
N+C	20.9 (2.84)	14.0 (1.05)	19.6 (1.91)

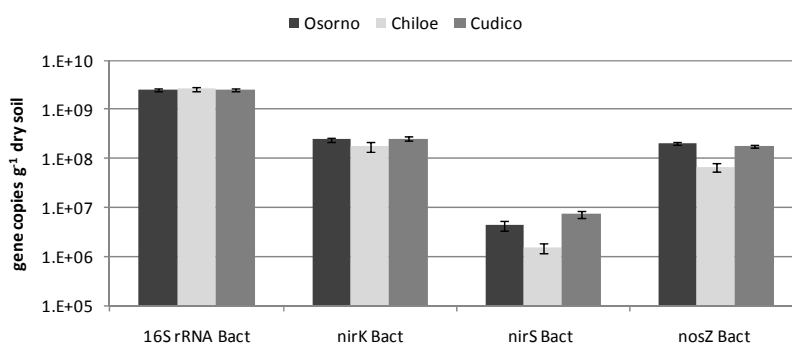

Figure 1. Quantitative real-time PCR estimates of gene abundance.

4. Conclusions

This study showed that under optimum conditions there is a large potential for N losses via emissions of N₂O after addition of N fertiliser in these volcanic soils likely due to their high carbon content. The microbial analyses showed that there is larger potential for denitrification in the two soils that showed significantly larger N₂O emissions, Osorno and Cudico.

References

- Alfaro M, Cárdenas L, Salazar F, Hatch D. and Ramírez L. 2009. Low nitrogen leaching losses in andisols, advances in the processes involved. Proceedings of the 16th Nitrogen Workshop, Connecting different scales of nitrogen use in agriculture. Grignani C et al (ed) 28 de junio al 1 de julio, Turin, Italia. pp:115-116
- Carneiro, J., Cardenas, L.M., Hatch, D.J., Trindade, H., Scholefield, D., Clegg, C.D. and Hobbs P. 2010. A laboratory study on the effect of pre-treatment with a nitrification inhibitor (Dicyandiamide) on an arable soil fertilized with ammonium sulphate. Environ Chem Lett 8, 237-246
- World Resources Institute, 2000, in <http://www.fao.org/index.php?id=24781>

Prediction of mineral nitrogen content in deeper layers of soil in Lithuania based on its concentration in surface layers

Staugaitis, G., Arbaciauskas, J., Mazvila, J., Vaisvila Z., Adomaitis, T.,
Sasnauskaite, L., Staugaitiene, R., Mazeika, R.

Agrochemical Research Laboratory of the Lithuanian Research Centre for Agriculture and Forestry, Kaunas, Lithuania

1. Background & Objectives

Since 1985, aiming to increase nitrogen fertilizer utilization efficiency and to reduce environmental pollution with nitrogen compounds, the mineral nitrogen ($N_{\min.}$) method was employed for making recommendations on crop nitrogen fertilization in Lithuania (Pliupelyte et al., 1986). Research evidence suggests that $N_{\min.}$ present in 0-60 cm soil layer at winter wheat vegetation resumption stage correlated with the yield of winter wheat best with winter wheat yield, for spring barley – in spring before fertilization (Staugaitis et al., 2007). Since 2006, in order to assess nitrogen fertilizer use efficiency, soil samples for determination of $N_{\min.}$ concentration have been taken down to the 90 cm depth not only in spring, but also in autumn, at the end of October – beginning of November (Staugaitis et al., 2008). The objective of this study was to find out if it is possible to predict N availability in the deeper soil layers based on N concentration determined in surface layers.

2. Materials & Methods

The studies were conducted in 2006-2009 in different regions of Lithuanian major soil typological units of various textures. Soil samples were collected from 20x20 m plots: in spring – within the first or second ten days of April (before nitrogen fertilization) and in autumn – within the last ten days of October or first ten days of November from 0-30, 30-60 and 60-90 cm layers of soil. Colometry method was employed for measuring of $N_{\min.}$ content in soil samples ($N-NO_3$ – using hydrazine sulphate and sulphanilamide; $N-NH_4$ – using sodium phenolate and sodium hypochlorite). Statistical analysis was performed using the computer program STATISTICA (Clewer, Scarisbric, 2001).

3. Results & Discussion

Evidence presented in Table 1 suggests that the ratio between $N_{\min.}$ concentration in deeper layers of soil and that in surface layer tended to be smaller when conditional $N_{\min.}$ concentration in 0-30 cm layer of soil increased.

Table 1. Ratios between $N_{\min.}$ concentrations determined in different soil layers

Conditional $N_{\min.}$ concentration in 0-30 cm soil layer mg kg ⁻¹	Cases	Soil layers compared, cm		
		0-60:0-30	0-90:0-30	0-90:0-60
Ratios between $N_{\min.}$ concentrations				
< 6.6	685	0.83	0.74	0.90
6.6-13.3	511	0.80	0.69	0.86
>13.3	84	0.74	0.59	0.81
Average for all cases	1280	0.80	0.69	0.87

Correlation between $N_{\min.}$ concentrations in deeper and surface soil layers was best expressed by linear equation (Table 2). Correlative relations were strong and significant, thus the concentration of $N_{\min.}$ in deeper soil layers can be calculated using the available data on $N_{\min.}$ concentration in surface layer of soil.

Table 2. Dependence of mineral nitrogen concentration, in deeper soil layers, on its concentration in the surface layer of Lithuania's soils

Conditional $N_{\min.}$ concentration in 0-30 cm soil layer mg kg^{-1}	Cases	Soil layer cm		Equation type	R^2	P
		y	x			
< 6.6	685	0-60	0-30	$y = 0.078 + 0.811x$	0.722	< 0.01
		0-90	0-30	$y = 0.150 + 0.709x$	0.560	< 0.01
		0-90	0-60	$y = -0.173 + 0.941x$	0.897	< 0.01
6.6-13.3	511	0-60	0-30	$y = -0.378 + 0.840x$	0.645	< 0.01
		0-90	0-30	$y = -0.015 + 0.690x$	0.455	< 0.01
		0-90	0-60	$y = -0.426 + 0.923x$	0.892	< 0.01
>13.3	84	0-60	0-30	$y = 1.919 + 0.637x$	0.785	< 0.01
		0-90	0-30	$y = 2.124 + 0.484x$	0.632	< 0.01
		0-90	0-60	$y = -0.167 + 0.818x$	0.932	< 0.01
Average for all cases	1280	0-60	0-30	$y = 0.574 + 0.717x$	0.904	< 0.01
		0-90	0-30	$y = 0.905 + 0.566x$	0.804	< 0.01
		0-90	0-60	$y = 0.283 + 0.818x$	0.956	< 0.01

Differences between the parameters of correlation equations calculated for different soil nitrogen status groups are small, therefore $N_{\min.}$ concentration in deeper soil layers can be calculated based on its concentration in the surface layer using average parameters of the linear equation for all soils of mineral origin.

4. Conclusion

Soils were grouped according to the nitrogen content in 0-30 cm soil layer, then simple linear equations were developed for the calculation of $N_{\min.}$ concentrations in deeper layers of soil. It is possible to calculate the $N_{\min.}$ concentrations in deeper layers of soil with sufficient accuracy for all soils of mineral origin without grouping them. In most cases, the correlations determined were very strong and significant.

References

- Clewer A.G. and Scarisbrick D.H. 2001. Practical statistics and experimental design for plant and crop science. – New York, USA, – pp. 331.
- Pliupelyte E., Lazauskas S., Matusevicius K. and Vaisvila Z. 1986. The dependence of winter wheat yield and the efficacy of nitrogen fertilizers on the amount of mineral nitrogen in soil in Lithuanian conditions. *Agrochimija* 10, 44-51 (in Russian).
- Staugaitis G., Vaisvila Z., Mazvila J., Arbaciauskas J., Adomaitis T. and Fullen M.A. 2007. Role of soil mineral nitrogen for agricultural crops: Nitrogen nutrition diagnostics in Lithuania. *Archives of Agronomy and Soil Science* 53, 3, 253-261.
- Staugaitis G., Mazvila J., Vaisvila Z., Arbaciauskas J., Dalangauskiene A. and Adomaitis T. 2008. Mineral nitrogen in Lithuanian soils. *Zemes ukiu mokslai*. 15, 3, 59-66.

Regulatory effect of soil properties on N₂O emission from wheat-growing season in five soils: field and pot experiment

Lebender, U., Senbayram M.

Research Center Hanninghof, Yara International, Dülmen, Germany

1. Background & Objectives

Soils are a major source of N₂O emission and the two biological processes (nitrification and denitrification) are responsible for its production. Chemical and physical properties of soils such as texture and total carbon (C) are important variables which control the formation of N₂O from these processes. However, the impact of these variables on regulatory mechanisms of N₂O formation is still poorly understood. The first objective of this study is to compare five German soil types for their N₂O emission during the wheat-growing season under field conditions. In addition to the field experiment, the potential denitrification and respiration rate of the soils have been tested in incubation experiments under standardized anoxic conditions.

2. Materials & Methods

In experiment one, five field trials were conducted to test the effect of soil properties on N₂O emissions during the wheat growing season. The soils at each site differ in texture, carbon content (1.31-1.9% total organic C) and pH (5.3-7.4). On each field site, N-fertilizer was applied as calcium-ammonium-nitrate (CAN) at a rate of 220 kg N ha⁻¹ in 3 split applications (80-70-70 kg N ha⁻¹). In experiment two, we set up an incubation experiment under complete anoxic conditions with the soils that have been collected from each field site. The denitrification potential and respiration rate of soils were measured. Briefly, 1 kg moist soil was placed in PVC vessels with porous ceramic plates at the bottom, flooded with 15 mM KNO₃ and drained to 20% gravimetric water content. The incubation atmosphere was replaced by helium (He) to remove atmospheric nitrogen. During the incubation period, fresh He was directed through an inlet in the lid with a flow rate of 15 ml vessel⁻¹ min⁻¹. Gas samples from the incubation vessels were automatically analyzed twice per day by ECD (N₂O) and TCD (N₂) detectors (gas chromatography, GC-450 Varian Inc., USA).

3. Results & Discussion

In the field experiments, N₂O emissions from soils with N-fertilizer application were significantly higher during the growing season than control (non fertilized) soils at all field sites (Fig 1). Cumulative N₂O emissions ranged between 747 to 1078 g N₂O-N*ha⁻¹ (Figure 1). In this experiment, cumulative emissions at the Münster (loamy soil) and Osnabrück (loamy sand soil) sites were significantly higher than at the other field sites. Soil at the Münster site had the highest total C content and that may have provided favourable conditions for both nitrification and denitrification. However, high N₂O emission at the Osnabrück site was surprising, as the soil at this site had moderate carbon content when compared to the other soil types. In the incubation experiment, the denitrification rate of soils ranged between 0.15 to 0.3 mg N kg soil⁻¹ hour⁻¹. There was a weak correlation between the denitrification potential and the total organic carbon content (Figure 2A). Labile soil organic carbon compounds trigger denitrification by providing energy for the denitrifiers (Weier et al., 1993). However, soil organic matter is a heterogeneous mixture of various organic matter pools which may have different decomposition rates. Therefore total soil organic matter content is not a direct measure of labile carbon content of soil; thus we also measured respiration rate of each soil under standardized aerobic conditions. The denitrification potential of soils correlated significantly with the soil respiration rate (Figure 2B).

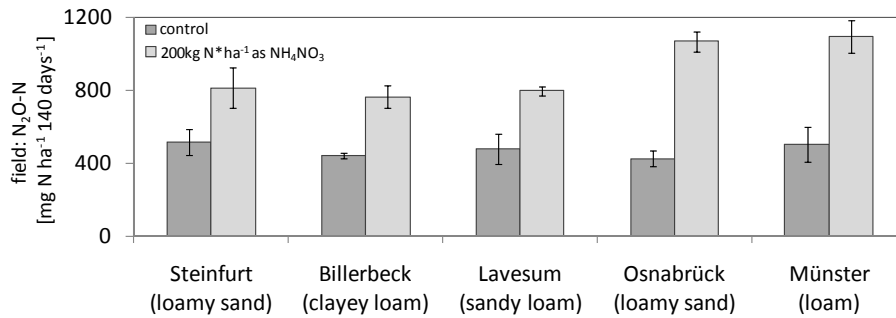

Figure 1. Cumulative N₂O emissions in g N₂O-N*ha⁻¹ at different field sites in North Western Germany during the vegetation period of winter wheat. Error bars show the standard error of the mean of each treatment (n=3).

There was a weak correlation between cumulative field N₂O emissions and denitrification potential (Figure 2C). The weakness of the correlation may be due to other factors such as soil physical properties or differences in crop N uptake in different fields. Surprisingly, there was a significant positive relationship between denitrification potential and maximum mean daily field N₂O fluxes (Figure 2D).

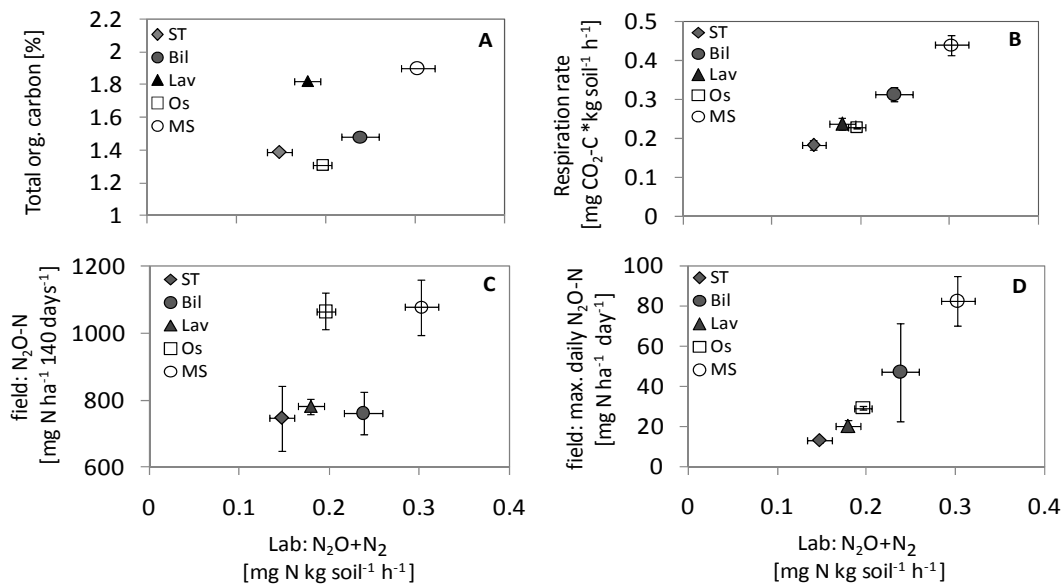

Figure 2. The relationship between total organic carbon content of soil (A) respiration rate (B), cumulative N₂O emissions from field (C) and highest daily N₂O emissions from field (D) with potential denitrification rate in five soils (ST=Steinfurt, Bil=Billerbeck, Lav=Lavesum, Os=Osnabrück, MS=Münster). Error bars show the standard error of the mean of each treatment (n=3).

4. Conclusion

Present field and incubation experiments showed that, a higher level of available carbon content of soils (rather than total soil organic matter content) induced higher N₂O emission and denitrification rate. There was a weak correlation between potential denitrification rate and cumulative N₂O emitted under field conditions over a whole season. However, maximum daily N₂O fluxes correlate significantly with the denitrification potential of soils which may indicate that N₂O emissions during high peak events were derived mainly from denitrification.

References

Weier, K. L, Doran, J.W, Power, J.F. and Walters, D.T. 1993. Denitrification and the Dinitrogen/Nitrous Oxide Ratio as Affected by Soil Water, Available Carbon, and Nitrate. *Soil Science Society of America Journal* 57, 66-72

Response of corn (*Zea mays* L.) to precision injected dairy slurry with focus on nitrogen

Bittman, S., Hunt, D.E., Kowalenko, C.G.

^a Pacific Agri-food Research Centre, Agriculture and Agri-Food Canada, Agassiz BC, Canada

1. Background & Objectives

Despite a surplus of manure on many dairy operations, farmers supplement their corn (*Zea mays* L.) crops with mineral N and P fertilizer, usually applied as a starter with the planter. On-farm and research experiments in British Columbia (BC), Canada have shown that starter fertilizer is beneficial to the crop even when large amounts of manure is broadcast (Bittman et al., 2006; Bittman et al., 2004). We have shown that injected dairy sludge placed near corn rows provides starter P to corn crops with no injury to the crop under cool moist spring conditions in coastal BC (Bittman et al., 2012). The objective of his study is to assess the response of silage corn to different rates of dairy slurry injected at 5-10 cm from the corn seed furrow relative to broadcast manure and chemical fertilizer.

2. Materials & Methods

The study was conducted in 2010 and 2011 on silty loam soil at the Pacific Agri-Food Research Centre in south coastal BC, Canada. The dairy slurry, obtained from a commercial dairy farm with high-producing Holstein cows fed grass and corn silages and bedded with saw dust, was stored in a 3 m deep tank over winter. The slurry was injected at 75 cm spacing and 15 cm depth using offset disk tools at rates to give 80, 160 and 240 kg total N ha⁻¹ (28.8, 57.6, 86.4 m³ ha⁻¹); the furrows were manually covered soon after application to reduce ammonia loss. Broadcast manure was applied and immediately incorporated by hand. Corn (Pioneer 38B11RR) was planted approximately 7-10 days after manure injection to allow time for the slurry to soak into the soil. Corn was planted at 75000 seeds ha⁻¹ planted at 5-10 cm distance from the centre of the manure furrow with a conventional corn planter with or without starter N and P fertilizer at seeding. The starter was applied at 24 and 29 kg ha⁻¹ of N and P, respectively, as a blend of urea and mono-ammonium phosphate. The experiment was arranged in 4 randomized complete blocks and we measured yield and uptake of nutrients. We sampled the middle 2 rows of 8-m long plots with 4-rows.

3. Results & Discussion

There was a curvilinear response of corn yield to applied mineral N at 29 kg P ha⁻¹ with a peak of 18.5 t dry matter ha⁻¹ at 160 N kg ha⁻¹ of N (Figure 1). The crop responded to broadcast and incorporated slurry in a linear fashion with the low and high rates corresponding closely to the mineral N fertilizer without P treatment. Corn yield responded more to the injected manure treatment probably due to a greater concentration of nutrients near the seed (Bittman et al., 2012) and to less ammonia volatilization losses. The broadcast manure with starter (typical farm practice) yielded the same as the injected manure without starter. Yield with injected manure, having very low potential for volatilization losses, was lower than with mineral fertilizer except at the high rates. At the high rates, more P was applied with manure but the convergence of yield was more likely due to the higher rate of available N as a high P fertilizer treatment (not shown) was similar to the 29 kg P ha⁻¹ rate. Adding starter fertilizer to the injected manure minimized any difference in whole crop yield between injected manure and mineral fertilizer at equivalent rates of N. Likewise there was lower grain yield at harvest with injected manure than with mineral fertilizer and starter fertilizer application diminished any difference between the treatments (not shown). Grain

percentage and dry matter content in the whole crop was similar for injected manure and fertilizer treatments suggesting no delay in final maturity with injected manure.

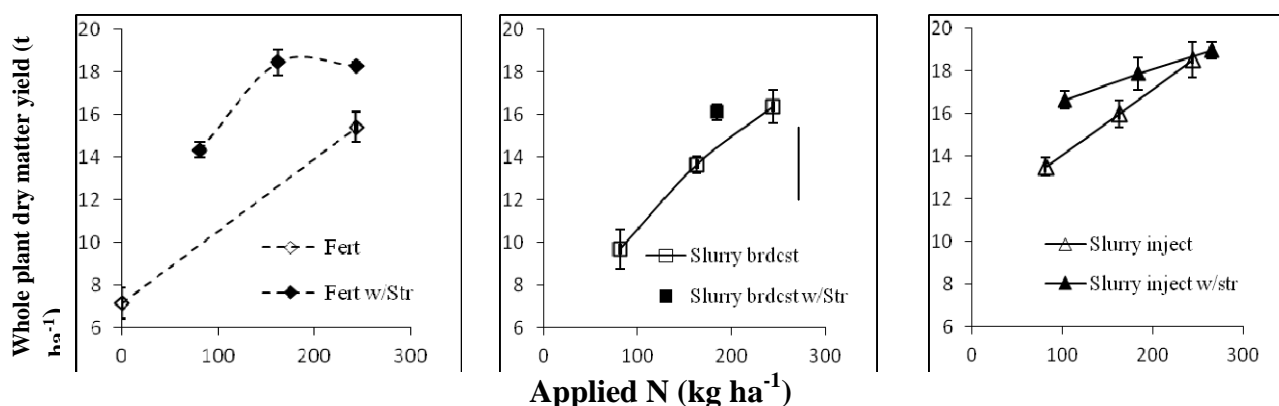

Figure 1. Whole plant yield of corn (mean of 2010 and 2011) in response to applications of fertilizer (Fert) and dairy slurry by broadcasting (brdcast) and precision placement (inject) near seed. Starter fertilizer (Str) provided 24 kg N ha⁻¹ and 29 kg P ha⁻¹.

4. Conclusion

This study shows corn responds better to slurry injected near corn seed than to broadcast and incorporated slurry. Starter fertilizer can be used to augment yield of manure-treated corn or, alternatively, higher rates of manure can be applied. The higher manure rates would lead to accumulation of P in the soil but would obviate the need for chemical fertilizer for intensive corn. Where maximum corn yields are not needed, slurry may be injected at sustainable rates with no additional chemical fertilizer. Work is continuing on the effects of injected manure on nitrate leaching, emission of nitrous oxide and long term release of N.

References

- Bittman S., Hunt D.E., Kowalenko C.G., Wu X. and Forge T.A. 2004. Early phosphorus nutrition in corn and the role of mycorrhizae, In: Bittman S. and Kowalenko C.G. (eds.), *Advanced silage corn management*. Pacific Field Corn Assoc., Agassiz, BC. pp. 42–48. Available at <http://www.farmwest.com/index.cfm?method=library.showPage&librarypageid=132> (veri. 29 Dec. 2011).
- Bittman S., Kowalenko C.G., Hunt D.E., Forge T.A. and Wu. X. 2006. Starter P fertilizer and broadcast nutrients on corn with contrasting colonization by arbuscular mycorrhizae. *Agronomy Journal* 98, 394-401.
- Bittman S., Liu A., Hunt D.E., Forge, T.A., Kowalenko C.G., Chantigny, M. and Buckley K. 2012. Precision Placement of Separated Dairy Sludge Improves Early Phosphorus Nutrition and Growth in Corn (*Zea mays* L.) *Journal of Environmental Quality* 41, (in press).

Role of soil organic matter content on nitrogen dynamics in volcanic ash soils

Alfaro, M.^a, Cárdenas, L.^b, Salazar, F.^a, Rosas, A.^a, Vistoso, E.^a, Hube, S.^a, Ramírez L.^a

^aINIA Remehue, Ruta 5 Sur, km 8, Osorno, Chile

^bRothamsted Research, North Wyke, Okehampton, Devon EX20 2SB, UK

1. Background & Objectives

Previous studies have shown that nitrogen (N) leaching losses are low in Chilean volcanic soils (Salazar et al., 2011), despite a high potential for available N production in the soil (Dixon et al., 2011). This could be related to the high soil organic matter content (SOM) of these soils, which could act as a buffer for N losses. The objective of this paper was to evaluate the fate of ¹⁵N added to soils with different SOM.

2. Materials & Methods

A monolith lysimeter experiment was carried out between May 2010 and March 2011 to determine the fate of N applied as inorganic fertilizer to three volcanic ash soils of southern Chile. Lysimeters (0.60 m depth, 0.11 m²) were collected in April 2010 from permanent grassland sites with no grazing from the Osorno (Typic Hapludands, 17% SOM), Cudico (Typic Hapludults, 14% SOM) and Chonchi series (Acruoxic Durudands, 24% SOM) (CIREN, 2003). All soils were transported to INIA Remehue (40° 35' S 73° 12' O) so that they were managed under similar temperature and rainfall conditions. All lysimeters received a basal application of P, K, S and Mg (66, 100, 40 and 17 kg ha⁻¹, respectively). The fate of the added N was evaluated with the overcast application of smashed fertilizer, equivalent to 200 kg N ha⁻¹, as 10 atom % ¹⁵N ammonium sulphate, with four replicates. During the experimental period, yield and ¹⁵N plant uptake, available N and ¹⁵N leaching losses and N₂O emissions were measured. The pasture was harvested each time it reached 20 cm height leaving a 5 cm residue (n=7). Cut grass was oven-dried (60°C) for 24-48 h and analyzed for total N and ¹⁵N concentration. Total and ¹⁵N plant uptake was calculated as the result of yield and N concentration in the respective grass sample (g N m⁻²). Leachate samples were collected from the bottom of the lysimeters three times per week during the drainage period (May-October 2010) and the samples were analysed for total N, NH₄⁺, NO₃⁻ and ¹⁵N. Total and ¹⁵N leaching losses were calculated from the cumulative of the individual losses at all sampling occasions estimated from the recorded volume of drainage and N concentration in the respective samples (kg N ha⁻¹). Gas samples were taken periodically for up to 50 days (n=14) following N application at time 0 and time 45 mins with the use of hermetic lids that were used to cover the top of the lysimeters without disturbing the soil surface. Samples were analysed for N₂O by gas chromatography. Total emissions were estimated as the sum of emissions per sampling period (g N ha⁻¹ day⁻¹). Rainfall was recorded with the use of an automatic weather station placed within 1 km distance of the experimental site. Soil temperature (0-10 cm depth) was recorded manually at each sampling time with the use of a soil thermometer. ANOVA was used to analyze statistical differences between treatments, using Genstat 12.0.

3. Results & Discussion

Soil organic matter contents varied between 14% (ultisil) up to 24% (andisil). During the experimental period rainfall reached up to 1008.4 mm, being 21% lower than the 33 year average value in the area. There was little difference in dry matter yield between the soils and fertilizer increased yield significantly (P<0.05; Figure 1a). During the first experimental year, an average of 45% of N taken up by plants came from the fertilizer, while the difference was supplied by the soil

(Figure 1b). During this period, N leaching losses were low from all three soils ($< 4 \text{ kg N ha}^{-1}$), and no ^{15}N was found in the leachate samples, indicating that N leached was soil derived.

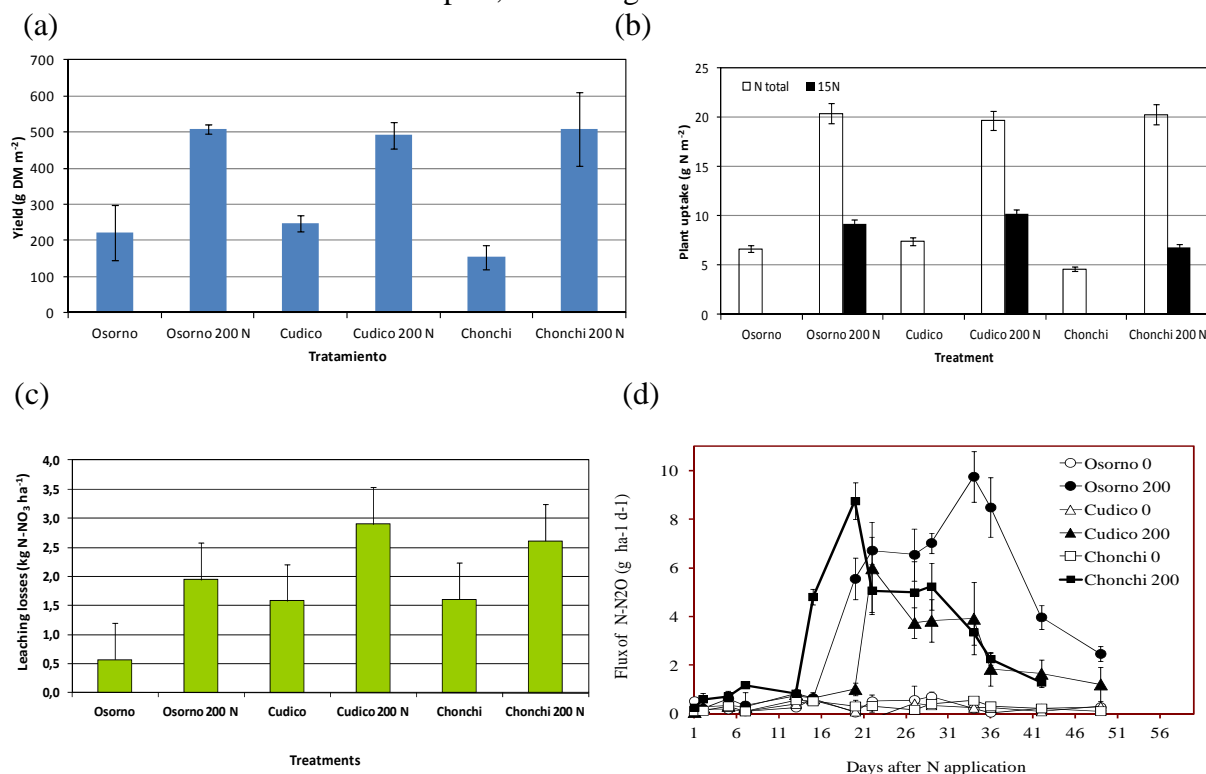

Figure 1. Nitrogen fate in volcanic ash soils with different soil organic matter content (a) yield (g DM m^{-2}), (b) plant uptake ($\text{g N}^{15}\text{N m}^{-2}$), (c) leaching losses ($\text{kg N-NO}_3 \text{ ha}^{-1}$), (d) flux of $\text{N}_2\text{O-N}$ ($\text{g ha}^{-1} \text{ d}^{-1}$).

Fluxes of $\text{N}_2\text{O-N}$ after N addition were low (less than $10 \text{ g N-N}_2\text{O ha}^{-1} \text{ day}$), with a significant effect of fertilizer addition ($P < 0.05$, Figure 1d). A lag period of 11-15 days was required for the formation of adequate conditions for N_2O production. Greater relative losses were found in the Cudico soil (1500 times greater) than in the andisols (Osorno and Chonchi). Results suggest that N dynamics in highly organic volcanic ash soils of southern Chile differ from that found in non volcanic soils and that there are factors other than SOM controlling N fate in these soils. We suggest that N adsorption in the soil profile and different microbial responses could be responsible for the low losses in these soils.

4. Conclusion

Direct addition of N fertilizer to highly organic volcanic soils of southern Chile do not result in direct N losses to the environment during the first year of analysis. Chemical soil characteristics may strongly influence N adsorption in the soil profile, but this requires further investigation.

Acknowledgements Fondecyt 1100300. Dr. Cárdenas is funded by SoilCIP, sponsored by BBSRC.

References

- CIREN. 2003. Estudio agrológico X Región. Vol. II. Centro Recursos Naturales, Santiago.
- Dixon, L., Cárdenas, L., Alfaro, M., Salazar, F. and Hatch, D. 2011. High rates of nitrogen cycling in volcanic soils from Chilean grasslands. *Rapid Communications in Mass Spectrometry* 25, 1-6.
- Salazar, F., Alfaro, M., Ledgard, S., Iraira, S., Teuber, N. and Ramírez, L. 2011. Effect of the stocking rate and land slope on nitrogen losses on a grazed pasture of Southern Chile. *Journal of Soil Science and Plant Nutrition* 11, 98-109.

Seasonal variation of nitrous oxide emissions from grazed and fertilized grasslands in Galicia (Spain)

Louro, A., Báez, D. M., García, M.I., Castro, J.

INGACAL-Centro de Investigaciones Agrarias de Mabegondo (CIAM). Apartado 10, 15080.A Coruña, Spain.

1. Background & Objectives

Humid and temperate climatic conditions in Galicia (North-western Spain) are favourable for the growing of grasslands, which account 37% of the agricultural area. With respect to nitrous oxide emissions these conditions could also be favourable, particularly if grasslands are grazed. There are many studies where N₂O is measured in grassland but most of them have been conducted in northern latitudes of Europe. The aim of this study was to quantify annual N₂O emissions and its seasonal pattern in our local conditions of humid North-western Spain.

2. Materials & Methods

Measurements of N₂O emissions were made at the experimental farm of CIAM (43°N latitude, 8°W longitude, 94 m altitude) during three years: 2007-2009 on a silt loam soil with a pasture consisting of perennial ryegrass (*Lolium perenne* L) and white clover (*Trifolium repens*). Within the dairy farm, six plots were selected in the grazing area and two control plots (no grazing and no N fertilizer application) were established for the measurement of background N₂O emissions. Inorganic N fertilizers were applied in spring and autumn to provide adequate amounts of mineral N and to maintain grass production levels for livestock. A rotational grazing pattern was practiced and the number of cow grazing days was calculated taking into account grazing events (Bossue and Chambaut, 2006). Total N deposited by the livestock was calculated in base to the amount of N intake by livestock with pasture and concentrates minus the amount of N extracted with milk and meat (Roca et al., 2011). Within each plot, four closed chambers were placed to monitor N₂O fluxes. Gas samples were analysed by gas chromatography with electron capture detection. Cumulative annual N₂O-N loss was calculated by interpolation between sampling days and the amount of N emitted as N₂O per year was expressed as a percentage of the total N applied with mineral fertilizers and N deposited by the livestock during the grazing seasons. In addition, soil samples (10 cm depth) for the measurements of soil moisture as water filled pore space (WFPS) and meteorological station data were taken to investigate the influence of weather and soil properties on N₂O fluxes.

3. Results & Discussion

Time course of N₂O fluxes during the experiment are shown in Figure 1. Higher emission peaks were associated with grazing periods, N fertilizer application and rainfall events. Accumulative annual N₂O emissions (Table 1) were in agreement of those reported by Velthof et al., (1997) and McTaggart et al. (1994) conducted in grazed and fertilized grasslands. In the first years, 2007 and 2008, autumn season contributed 45% to the total N-N₂O emitted whereas spring contributed a lower percentage of 35%. A lower N₂O emission was observed in 2007 than in 2008, despite that, in the first year the N applied as fertilizer was higher than in 2008. The reason for this could be the lower rainfall, 63% of 2008 rainfall, and consequently lower WFPS in soil (from a mean value of 55 % in 2007 to 72% WFPS in 2008). There was no difference between 2008 and 2009 in rainfall, nevertheless in the last year the highest cumulative N₂O flux was found, with spring being the season that contributed most to the total amount of N lost as N₂O; 48% in total. The effects of grazing animals (277 cow grazing days ha⁻¹) due to the N input via urine and dung and compaction

of the soil by treading (Hynst et al., 2007), in addition to wet soil conditions (with a mean WFPS of 73%) optimum for N₂O production, could be the reasons for the larger N₂O emissions.

Table 1. Nitrogen inputs from fertilizers and livestock excretions, cumulative N₂O losses \pm standard deviations in grazed (G) and control (C) plots.

Year	Plot	Number of cow grazing days ha ⁻¹	N fertilizer (kg N ha ⁻¹)	N deposited by livestock (kg N ha ⁻¹)	N-N ₂ O loss (kg N ha ⁻¹)
2007	C	0	0	0	4.3 \pm 0.1
	G	541 \pm 93	143 \pm 20	34 \pm 6	8.8 \pm 1.1
2008	C	0	0	0	9.2 \pm 0.1
	G	418 \pm 144	91 \pm 19	26 \pm 9	14.5 \pm 1.0
2009	C	0	0	0	10.1 \pm 0.2
	G	644 \pm 170	37 \pm 4	40 \pm 11	22.0 \pm 2.3

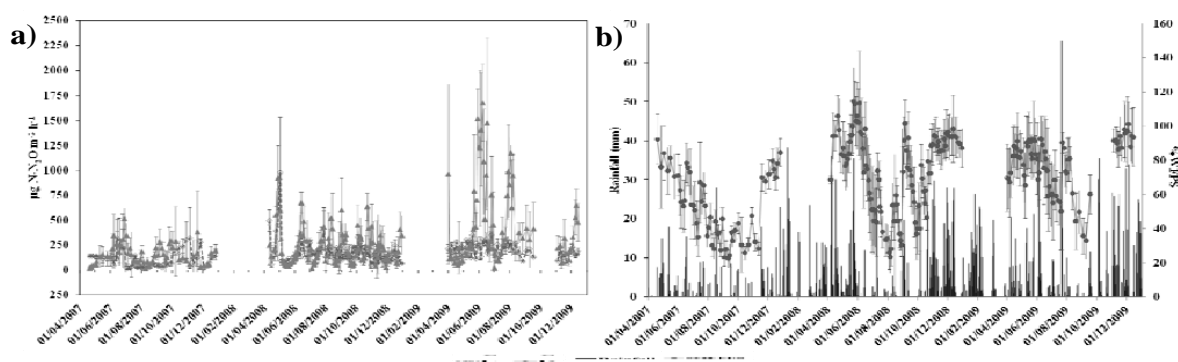

Figure 1. a) Nitrous oxide emission fluxes from grazed grasslands during 2007, 2008 and 2009. C: Control (n:2 plots), G: Grazed (n:6 plots). b) Rainfall and Water-Filled Pore Space (WFPS). Data represent means \pm standard deviation for emission rates and WFPS.

4. Conclusion

Highest N₂O peaks were found in spring directly in relationship with grazing and/or fertilization events. Sampled plots showed considerable changes in N₂O annual cumulative values due to differences between climatic conditions in the three years studied, fertilization events and grazing pressure. Soil compaction due to large grazing events in conjunction with wet conditions stimulated N₂O production in 2009, being the year with the highest annual fluxes.

References

- Bossuet, I. and Chambaut, H. 2006. Green Dairy experimental sites: Methodological protocol. Study of mineral flows on dairy systems in experimental farms. Report of the campaign 2004-2005; Green Dairy Project n°100, ref. 19 06 33 008.
- Hynst, J., Simek, M., Brucek, P. and Petersen, S.O. 2007. High fluxes but different patterns of nitrous oxide and carbon dioxide emissions from soil in a cattle overwintering area. *Agriculture, Ecosystems and Environment*, 120, 269-279.
- McTaggar, I., Clayton, H. and Smith, K. 1994. Nitrous oxide flux from fertilized grassland; strategies for reducing emissions. In: van Ham J et al.(Eds). *Non-CO₂ greenhouse gases*. Academic press, Dordrecht, 421-426.
- Roca Fernández, A.I., Báez Bernal, M.D. and González Rodríguez, A. (2011). Balance de nitrógeno en vacas de leche en pastoreo. In: López-Carrasco C. et al. (Eds), *Pastos, Paisajes culturales entre tradición y nuevos paradigmas del siglo XXI*, Sociedad española para el estudio de los pastos, pp 453.
- Velthof, G.L. and Oenema, O.1997. Nitrous oxide emissions from a dairy farm systems in the Netherlands. *Netherlands Journal Agricultural Science*, 45, 347-360.

Self-reseeding annual legume species as cover crops for rainfed olive orchards

Rodrigues, M.A., Ferreira, I.Q., Claro, M., Pires, J.M., Arrobas, M.
CIMO - Mountain Research Centre, Politecnico Institute of Bragança, Portugal

1. Background & Objectives

The ground of perennial crops must be permanently covered by herbaceous vegetation for soil protection (Lipecki and Berbeć, 1997). However, in rainfed orchards the growth of the vegetation should be kept controlled due to low water availability (Rodrigues et al., 2011). The cultivation of self-reseeding annual legumes may have advantages over natural vegetation. These species can fix atmospheric N and might be less competitive for water. In this work, results of ground-cover %, dry matter yield and N recovery are presented for several legume species sown in a rainfed olive orchard. The suitability of these plants to be grown as cover crops is tested, taking into account that these agrosystems are not grazed by animals. The self-seeding of the legumes over the years must be achieved by cutting the vegetation as a simulation of grazing.

2. Materials & Methods

Eleven species/varieties were sown in separated plots in a rainfed olive orchard in the region of Mirandela, NE Portugal, according to the following list: *Ornithopus compressus* L. cv. Charano, *Ornithopus sativus* Brot. cvs. Erica and Margurita, *Trifolium subterraneum* L. ssp. *subterraneum* Katzn. and Morley cvs. Dalkeith, Seaton Park, Denmark and Nungarin, *Trifolium resupinatum* L. ssp. *resupinatum* Gib and Belli cv. Prolific, *Trifolium incarnatum* L. cv. Contea, *Trifolium michelianum* Savi cv. Frontier and *Biserrula pelecinus* L. cv. Mauro. The ground-cover percentage was monitored for two consecutive years after sowing using the point sampling method to evaluate the proportion of legumes species in relation to natural vegetation. Dry matter (DM) yield and N recovery was determined from field samples of the above-ground biomass. Nitrogen concentration in plant tissues was determined by a Kjeldahl procedure. Data analysis consisted of the estimation of means and confidence limits ($\alpha < 0.05$) for comparison among species/varieties.

3. Results & Discussion

Late in spring, the vegetation was generally dominated by the sown legumes from the first year of installation (Figure 1). The tallest and late-maturing cultivars (Contea, Prolific, Denmark) benefited from the wet spring of 2010, with ground-cover close to 100% and substantially higher than that of the early-maturing cultivars (Nungarin, Dalkeith and Charano). In the spring of 2011 the ground-cover percentages were similar to that of the previous year, except for Prolific, which was severely damaged by winter frost. In 2010, DM yield and N recovery were higher for the late-maturing cultivars, benefiting from the long and wet spring of that year. Contea reached the highest DM yield and N recovery. Mauro produced the opposite result due to the problems of emergence (Figure 2). In 2011, during a dry spring, the late-maturing cultivars did not show great differences in DM yield and N recovery to the early-maturing cultivars (Figure 3). In the Prolific plot, only 35 kg N ha⁻¹ were recovered due to the negative impact of the winter frost on this particular species.

4. Conclusion

In spite of the higher dry matter yields and N recoveries of the late-maturing cultivars, the early maturing ones seem very promising as cover crops for the olive groves of the Mediterranean region. They can protect the soil and fix satisfactory amounts of N using less water than the late-maturing ones, since the biomass yielded is lower and their growth cycles finish earlier in spring.

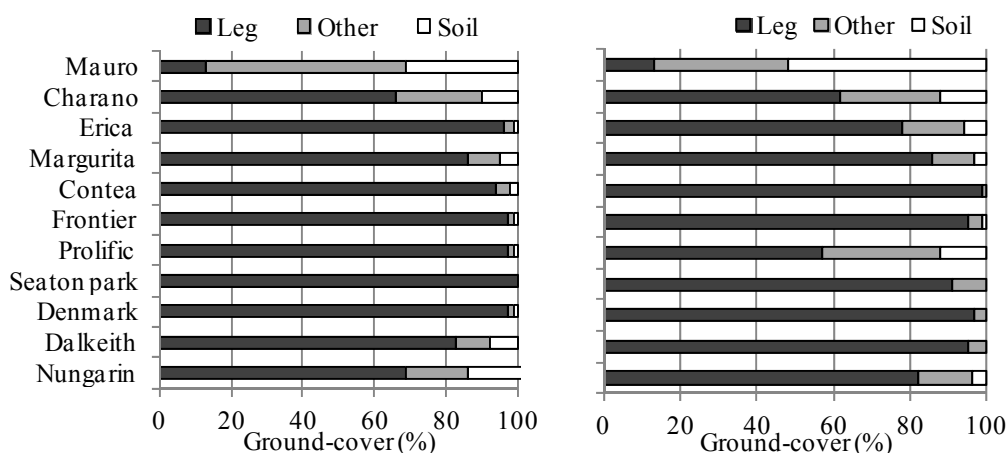

Figure 1. Ground-cover percentage by legumes and other species at May 13th 2010 (left) and May 3rd 2011 (right).

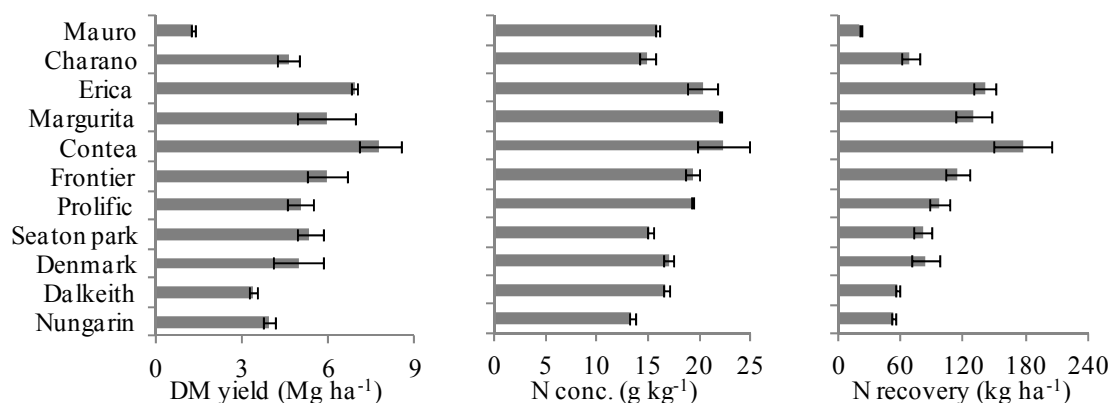

Figure 2. Dry matter yield, N concentration and N recovery in the different plots in the growing season of 2010.

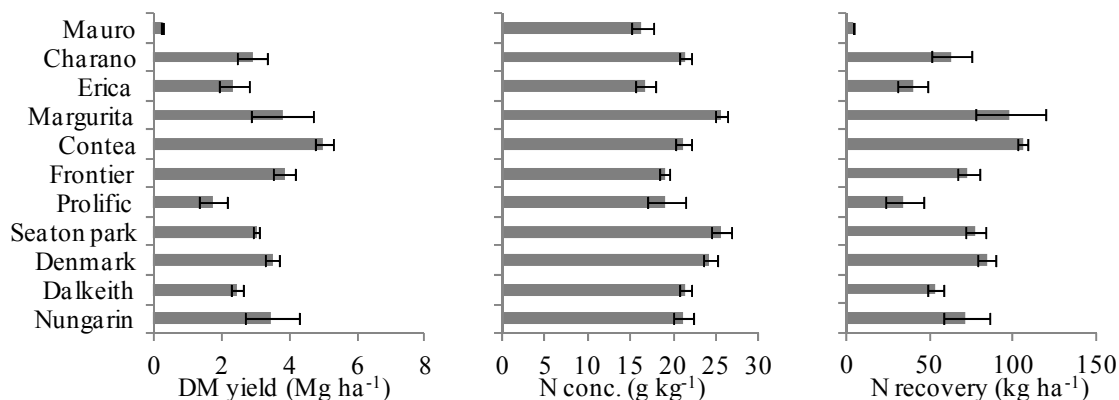

Figure 3. Dry matter yield, N concentration and N recovery in the different plots in the growing season of 2011.

References

Lipecki, J., and S. Berbeć. 1997. Soil management in perennial crops: orchards and hop gardens. *Soil and Tillage Research* 43, 169-184.
 Rodrigues, M.A., Lopes, J.I., Pavão, F.M., Cabanas, J.E. and Arrobas, M. 2011. The effect of soil management on olive yield and nutritional status of trees in rainfed orchards. *Commun. Soil Sci. Plant Anal.* 42, 993-2011.

Funded by FCT (Portugal) through the project PTDC/AGR-AAM/098326/2008.

Sensitivity of crop reflectance to crop N status of a melon crop

Peña, M.T.^a, Thompson, R.B.^a, Gallardo, M.^a, Gimenez, C.^b

^aUniversity of Almeria, Department of Crop Production, Almeria, Spain

^bUniversity of Cordoba, Department of Agronomy, Cordoba, Spain

1. Background & Objectives

The use of optical sensors to monitor crop N status is a promising approach to assess crop N status (Cartelat et al., 2005; Samborski et al., 2009). Their use *in situ* and in real time provides the potential for N fertiliser application to be rapidly adjusted to crop N status (Samborski et al., 2009). Such a corrective management system would take advantage of the high technical capacity for precise N application provided by the combined use of high frequency drip irrigation and fertigation in some horticultural systems, such as in the greenhouse based vegetable production system of the south-eastern (SE) Mediterranean coast of Spain (Thompson et al., 2007). Canopy reflectance has been evaluated with various cereal crops (Samborski et al., 2009), but little work has been reported with horticultural crops. This work examined the use of canopy reflectance to assess crop N status of a melon crop.

2. Materials & Methods

A cantaloupe type melon crop was grown in a loam soil in a greenhouse with polyethylene cladding in Almeria, SE Spain. The crop was transplanted as five week old seedlings on 19 April 2010 and grown for 78 days. The crop was drip irrigated and fertigated receiving complete nutrient solutions in all irrigations. The crop was vertically supported with nylon cord. Four different N treatments were applied, commencing 23 days after transplanting (DAT), being NO_3^- concentrations of 1, 7, 14 and 21 mM; 0.5 to 1.0 mM NH_4^+ was applied, in all treatments. The 14 mM NO_3^- was regarded as conventional management, the 21 mM as clearly excessive, and the 1 and 7 mM as N deficient. Plot size was 6 m x 6 m with six rows of plants per plot; the plots were organised in a randomised block design with four replicate plots per treatment. Canopy reflectance was measured with a hand-held Crop Circle ACS-470 sensor (Holland Scientific, Nebraska, USA). Reflectance was measured at 670 and 760 nm. Weekly measurements commenced on 36 DAT when plants were approximately 50 cm high, and approx. 20% of biomass production had occurred. Measurements were made on the inner 4 m of the four inside rows of each plot. Measurements were made with the sensor held vertically 60 cm from the upper part of the crop canopy; the vertical height measured was estimated to be 34 cm. The reflectance index used was NDVI (Normalized Difference Vegetation Index) = $(760-670)/(760+670)$. Five crop biomass samplings were made throughout the crop and the N content was determined. All data are means from four replicate plots. Reflectance and biomass samplings coincided on 43, 56 and 71 DAT.

3. Results & Discussion

The accumulation of biomass throughout the growing season was similar for the four treatments. There were appreciable differences in crop N uptake throughout the crop, the final total values being 119, 177, 225 and 259 kg N ha⁻¹ for the 1, 7, 14 and 21 mM NO_3^- treatments, respectively, and in shoot N content (Figure 1a) which were positively related to the applied N concentration. There were generally clear and consistent differences between NDVI values from the different treatments, with the NDVI values being positively influenced by the concentration of applied N (Figure 1b). On 43, 56 and 71 DAT, there were similar linear relationships between NDVI and the shoot N content (Table 1). The linear regression equation for the combined data (n = 12) of the

three dates was $NDVI = 0.0424 * \text{shoot N} + 0.6484$, with a coefficient of determination (r^2) of 0.864. These data suggest that the relationship between NDVI values and shoot N content was relatively constant during the last month of the crop when most biomass production occurred. This suggests that during, at least, the latter phase of a melon crop that fixed NDVI values can be used to assess crop N status. An important practical consideration is the minimum height of the crop at which canopy reflectance measurements can commence.

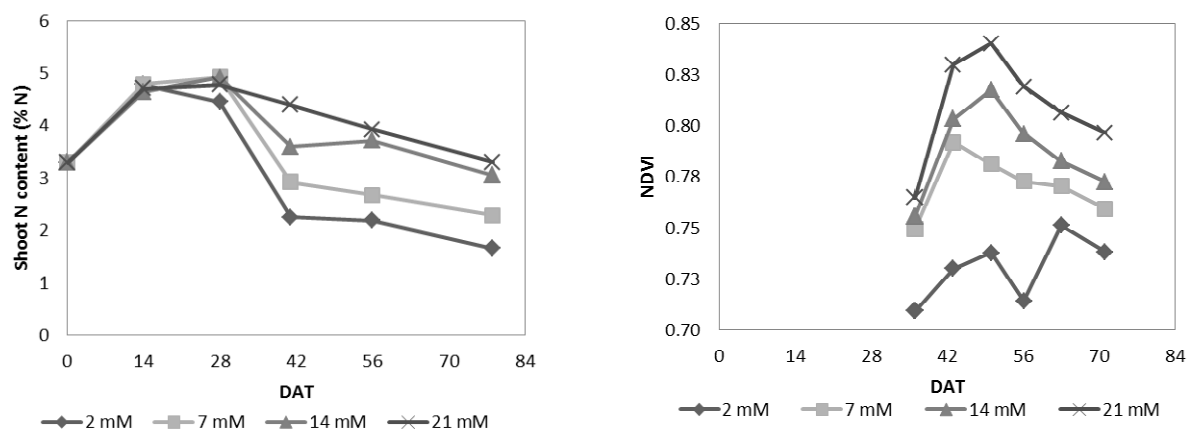

Figure 1. (a) Shoot N content of melon crops receiving nutrient solutions with 1, 7, 14 and 21 mM NO_3^- , (b) NDVI values of canopy reflectance measured in treatments receiving nutrient solutions with 1, 7, 14 and 21 mM NO_3^- . All values are means of four replicates

Table 1. Results of linear regression analyses between NDVI and the shoot N content at days 43, 56 and 71 after transplanting for the four N treatments.

Index	No. days after transplanting (DAT)	n	Slope	Intercept	Coefficient of determination (r^2)
NDVI	43, 56, 71	12	0.042	0.648	0.864
	43	4	0.043	0.646	0.890
	56	4	0.051	0.616	0.885
	71	4	0.035	0.671	0.845

4. Conclusion

Crop reflectance as NDVI was sensitive to shoot N content. In the last month of the melon crop when most biomass production occurred, there was a relatively constant relationship between NDVI and shoot N content.

References

- Cartelat, A., Cerovic, Z.G., Goulas, Y., Meyer, S., Lelarg, C., Prioul, J.L., Barbottin, A., Jeuffroy, M.H., Gate, P., Agati, G. and Moya, I. 2005. Optically assessed contents of leaf polyphenolics and chlorophyll as indicators of nitrogen deficiency in wheat (*Triticum aestivum* L.) *Field Crops Research* 91, 35-49
- Samborski, S.M., Tremblay, N. and Fallon, E. 2009. Strategies to make use of plant sensors-based diagnostic information for nitrogen recommendations. *Agronomy Journal* 101, 800-816
- Thompson, R.B., Martínez-Gaitán, C., Gallardo, M., Giménez, C. and Fernández, M.D. 2007 Identification of irrigation and N management practices that contribute to nitrate leaching loss from an intensive vegetable production system by use of a comprehensive survey. *Agricultural Water Management* 89, 261-274

Sensitivity of the ratio leaf chlorophyll to leaf flavonols measured with optical sensors to crop N status of melon

Peña, M.T.^a, Thompson, R.B.^a, Gallardo, M.^a, Gimenez, C.^b

^aUniversity of Almeria, Department of Crop Production, Almeria, Spain

^bUniversity of Cordoba, Department of Agronomy, Cordoba, Spain

1. Background & Objectives

Optical sensors are a promising approach to assess crop N status (Cartelat et al., 2005; Samborski et al., 2009). Their use *in situ* and in real time provides the potential for N fertiliser application to be rapidly adjusted to crop N status (Samborski et al., 2009). Such corrective management would be well-suited where the combined use of high frequency, drip irrigation and fertigation enables precise N application, such as in greenhouse-based vegetable production on the south-eastern (SE) Mediterranean coast of Spain. The SPAD meter estimates leaf chlorophyll content (Samborski et al., 2009). The content of leaf flavonols was reported to be an indicator of crop N status (Cartelat et al., 2005) who suggested that the ratio of leaf chlorophyll to leaf flavonols was particularly sensitive to crop N status. The current study examined the use of the ratio of leaf chlorophyll to leaf flavonols, both estimated with hand-held optical sensors, to assess crop N status of a melon crop.

2. Materials & Methods

A cantaloupe type melon crop was grown in a loam soil in a greenhouse with polyethylene cladding in Almeria, SE Spain. The crop was transplanted as 5 week old seedlings on 19 April 2010 and grown for 78 days. The crop was drip irrigated and fertigated receiving complete nutrient solutions in all irrigations. The crop was vertically supported with nylon cord. Four different N treatments were applied, commencing 23 days after transplanting (DAT), being NO_3^- concentrations of 2, 8, 15 and 23 mM; 0.4 mM NH_4^+ was applied in all treatments. The 15 mM NO_3^- was regarded as conventional management, the 23 mM as clearly excessive, and the 2 and 8 mM as N deficient. Total irrigation was 146 mm; and 34, 129, 241 and 373 kg N ha⁻¹ were applied to the 4 treatments. Plot size was 6 m x 6 m with six rows of plants per plot and 12 plants per row; the plots were organised in a randomised block design with four replicate plots per treatment. The SPAD-502 chlorophyll meter (Konica Minolta Sensing, Inc., Japan) was used to estimate leaf chlorophyll content. The DUALEX 4 FLAV sensor (Force A, Paris, France) was used to estimate the content of leaf flavonols. Measurements were made at weekly intervals commencing 22 days after transplanting (DAT). All measurements were made on the most recently expanded leaf on 16 plants per plot, using the same plants within each plot. Five crop biomass samplings were made throughout the crop and the N content was determined. All data are means from four replicate plots. Sensor and biomass samplings coincided on 28, 43, 56 and 71 DAT.

3. Results & Discussion

The accumulation of biomass throughout the growing season was similar for the four treatments. There were appreciable differences in crop N uptake throughout the crop, the final total values being 119, 175, 220 and 254 kg N ha⁻¹ for the 2, 8, 15 and 23 mM NO_3^- treatments, respectively, and in shoot N content (Figure 1) which were positively related to the applied N concentration. The ratio of leaf chlorophyll to leaf flavonols was strongly related to the applied N concentrations throughout the crop (Figure 2). There was a consistent general relationship between ratio of leaf chlorophyll to leaf flavonols and shoot N content (Figures 1 and 2). Linear regression analysis showed strong and significant ($P < 0.01$) linear relationships between the ratio of leaf chlorophyll to leaf flavonols and shoot N content on 43, 56 and 71 DAT with coefficient of determination (r^2)

values of 0.78 to 0.85; however, the slope and intercept values varied appreciably between each of these dates indicating that the relationship was not constant over time. The average coefficient of variation for all values of the ratio of chlorophyll to flavonols was 29%.

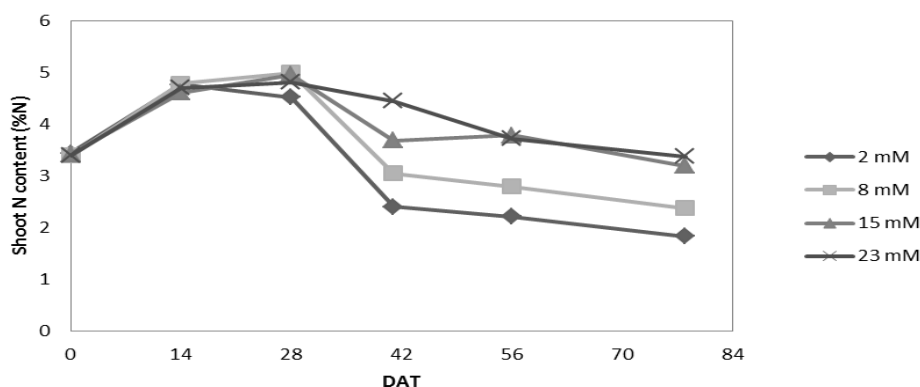

Figure 1. Shoot N content of melon crops receiving nutrient solutions with 2, 8, 15 and 23 mM NO_3^- throughout the crop after 23 DAT. All values are means of four replicates. DAT: days after transplanting.

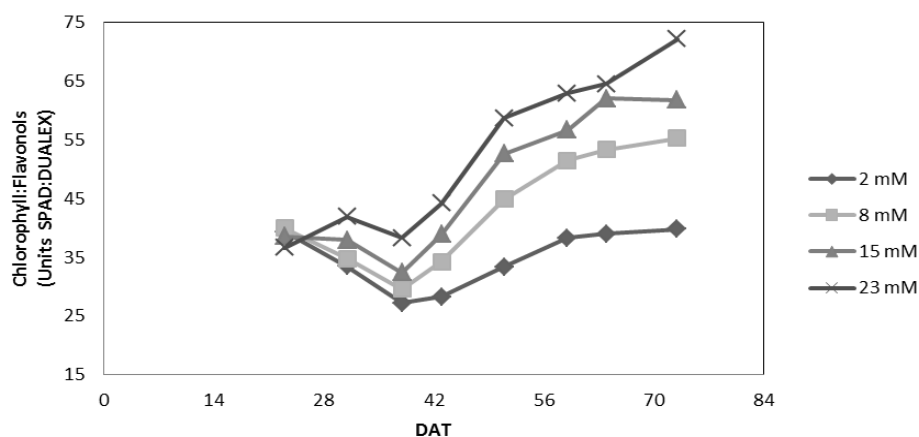

Figure 2. Ratio of leaf chlorophyll to leaf flavonols of a melon crop receiving nutrient solutions with 2, 8, 15 and 23 mM NO_3^- throughout the crop after 23 DAT. All values are means of four replicates. DAT: days after transplanting.

4. Conclusion

The ratio of leaf chlorophyll to leaf flavonols, was sensitive to shoot N content. There was no consistent relationship between this ratio and shoot N content suggesting that threshold values for N management would need to be determined at particular growth stages for melon.

References

- Cartelat, A., Cerovic, Z.G., Goulas, Y., Meyer, S., Lelarg, C., Prioul J.L., Barbottin, A., Jeuffroy M.H., Gate, P., Agati, G. and Moya, I. 2005. Optically assessed contents of leaf polyphenolics and chlorophyll as indicators of nitrogen deficiency in wheat (*Triticum aestivum* L.) *Field Crops Research* 91, 35-49
- Samborski, S.M., Tremblay, N. and Fallon, E. 2009. Strategies to make use of plant sensors-based diagnostic information for nitrogen recommendations. *Agronomy Journal* 101, 800-816

Site, preceding crop and N management effects on yield of organic winter oil seed rape

Engström, L.^a, Stenberg, M.^a, Wallenhammar, A.-C.^{a,b}, Ståhl, P.^c

^aSLU, Department of Soil and Environment, Skara, Precision Agriculture and pedometrics, Skara, Sweden

^bHS Konsult AB, Örebro, Sweden

^cHushållningssällskapet Rådgivning Agri AB, Linköping, Sweden

1. Background & Objectives

Plant nutrient supply is a key issue in production of organic winter oil seed rape (WOR). The variation in nitrogen (N) application and yield level varies greatly. The production of organic oil seed rape is often hazardous and the grower has to expect great variations in yield levels (Wallenhammar, 2005). WOR demands high amounts of available soil N to achieve an adequate yield. The N demand is large during the vegetative stages (Schultz, 1972), and variation in yield of WOR is due to availability of N during growth and development (Rathke et al., 2006). Excess N rates in spring can, however, increase leaching in the subsequent crop (Engström et al. 2011). There is a need to improve tools used by advisors and farmers to predict the N demand. The objective of this study was to increase the knowledge of the possibilities to adjust the N application by organic fertilizers to the previous crop and site with the aim to develop N management strategies for N application in organic WOR.

2. Materials & Methods

This study was carried out in 8 field experiments in south Sweden during 2009-2010. The effects of different N levels, under varying cropping history and soil type, were determined by quantifying the yield and N demand in relation to different soil parameters. The experiments were carried out in 40 plots at each site with a fully randomized two factorial design with four replicates and two levels of N application in autumn (F1) (0 or 50 kg N ha⁻¹) and five levels in spring (F2) (0, 50, 100, 150 or 200 kg N ha⁻¹). N was supplied in autumn as Biofer 10-3-1 (10% N, 3% P and 1% K) and in spring as Vinasse, a by-product from yeast production with on average 4% N and 4% K. Plants were sampled for analysis of dry matter yield. Soil mineral N content in 0-90 cm was quantified at sowing (August year 1), early spring and at harvest (August year 2). Seed yield and quality including seed N content was determined in each plot. Each experimental site was characterized regarding crop rotation history and several soil characteristics as soil texture, organic matter content and soil electrical conductivity. Statistical analysis of variance of treatment effects and interactions were carried out with the Mixed model procedure in SAS 9.2 (SAS Institute Inc., Cary, NC, USA).

3. Results & Discussion

Seed yields differed between sites and years and ranged from very low yields, about 500 kg ha⁻¹, to 4080 kg ha⁻¹ in plots without N fertilization. Yield increases from the autumn application was on average 135 kg (p=0.0012) and in spring 700 kg at the highest N level compared with no N (p<0.0001). Yield increases were up to 1400 kg ha⁻¹ at the highest spring N application rate recorded at a site with a long lasting set-aside as the preceding crop. There was no response from spring N application in three of the experiments when white clover and pasture constituted the preceding crops. These crops most likely contributed to high soil N availability during growth of WOR, thus explaining the high yield level in unfertilised WOR. A small N response was obtained at two sites with white clover and green manure as preceding crop. The weak N response at one site may be due to a dry period in spring reducing mineral N availability in the soil. The highest responses from spring N fertilisation were recorded in experiments with ley (mixed grass and clover) or a set-aside as preceding crops. Economical optimum N fertilisation was determined as N

rate at the highest net income assuming a seed price of 6 SEK kg⁻¹, N cost 22 SEK kg⁻¹ and cost for transport and drying 0.2 SEK kg⁻¹. Optimum N rate ranged from 68 to 190 kg N ha⁻¹ and the yield increase ranged from 824 to 1393 kg ha⁻¹. The highest N response was recorded after a 14 year old grass set-aside. Here the soil profile was likely depleted from mineral N and N immobilisation, which was considerable due to incorporation of crop residues with low N content. The high N response after the grass/clover leys may be caused by N leaching losses from sites with sandy soil and high rainfall.

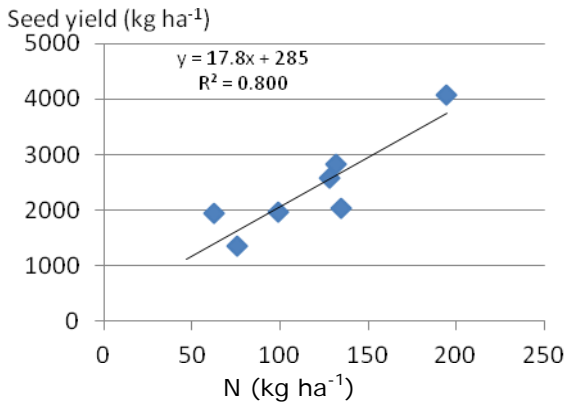

Figure 1. Late autumn soil mineral N and above ground plant N vs. seed yield in the 0N treatment of 7 sites.

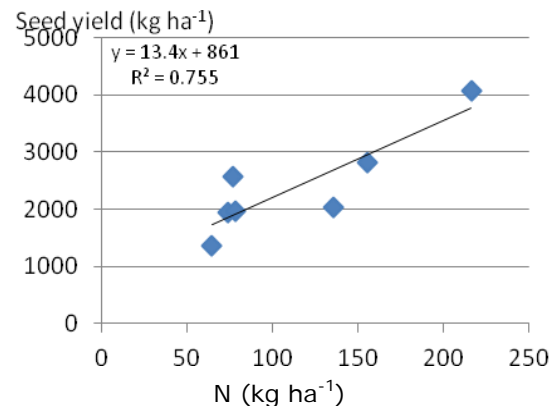

Figure 2. Spring soil mineral N and above ground plant N vs. seed yield in the 0N treatment of 7 sites.

Soil mineral N showed large variation between sites with on average almost 80 kg N in the control treatment at establishment of the crops. Despite a large N uptake during autumn there were considerable amounts of N in the soil profile in late autumn. Total N as soil mineral N at 0-90 cm depth along with above ground plant N, in late autumn (Figure 1) as well as in spring (Figure 2) showed significant ($p < 0.05$) correlation with seed yields in the 0 N treatment. Sites with high N delivery, depending on preceding crop and management history, during autumn were also the highest yielding as shown by the seed yields at the different N application rates. The variation in optimum N rate in spring could be explained best by N-uptake in autumn (x_1), soil mineral N in autumn (x_2) and yield level (x_3) at optimum ($y = 49 - 1.8x_1 - 1.9x_2 + 0.07x_3$; $P = 0.93$; $p < 0.001$).

4. Conclusion

The N response of spring N fertilisation varies depending on both preceding crop and on soil type as well as weather conditions. The results indicated that N uptake and soil mineral N in autumn as well as yield level x_1 should be considered when calculating optimum N-rate in spring. Autumn N fertilisation cannot be recommended to organic WOR with a good preceding crop (white clover, pasture or red clover) or with a late sowing date.

References

- Engström, L., Stenberg, M., Aronsson, H. and Lindén, B. 2011. Reducing nitrate leaching after winter oilseed rape and peas by optimising crop management. *Agron. Sustain. Dev.* 31, 337-347.
- Rathke, G.W., Behrens, T. and Diepenbrock, W. 2006. Integrated nitrogen management strategies to improve seed yield, oil content and nitrogen efficiency of winter oilseed rape (*Brassica napus* L.): A review. *Agr. Ecosys. Environ.* 117, 80-108.
- Schultz, J.E.R. 1972. Undersøgelser af vinterrapsens (*Brassica napus* L.) tørstofproduktion og næringsstoffoptagelse gennem vækstperioden. *Tidsskrift for Planteavl* 76, 415-435. (in Danish).
- Wallenhammar, A.C., Pettersson, B. and Redner, A. 2005. Ekologisk oljevæxtodling kartlagd i fält. *Svensk Frötidning* 1, 18-21. (in Swedish).

Soil N₂O emission as affected by 3,5-Dimethylphirazolophosphate, a nitrification inhibitor, applied on different soil types in Southern Italy

Vitale, L.^a, Polimeno, F.^b, Ottaiano, L.^c, Maglione, G.^b, Fierro, A.^d, Di Tommasi, P.^a, Mori, M.^c, Magliulo, V.^a

^aCNR-ISAFoM, Ercolano (Na), Italy.

^bCNR-ISPAAM, Naples, Italy.

^cDIAAT, University of Naples Federico II, Naples, Italy.

^dDBSF, University of Naples Federico II, Naples, Italy.

1. Background & Objectives

Nitrous oxide (N₂O) is a greenhouse gas contributing 6% to global warming. It is emitted from soils by microbial processes of nitrification and denitrification which are controlled by different soil-related factors such as moisture, temperature and nitrogen content (Han Jian-gang et al., 2007). Recently, fertilizers have been produced which contain microbial inhibitors and are being widely used in intensive agricultural systems, where it is estimated that can reduce total N₂O efflux by up to 90% (Weiske et al., 2006; Pfab et al., 2009). In this study we analyze the effect of 3,5-Dimethylphirazolophosphate (DMPP), a nitrification inhibitor, on soil N₂O emission from two cropping systems (potato on a sandy soil and maize on a sandy loam soil).#

2. Materials & Methods

The experiments were carried out in two farms located in Naples and Acerra (southern Italy), on a sandy and a sandy-loam soil which were cropped with potato and maize crops, respectively. Two treatments were applied at both sites: nitrogenous fertilizer (ammonium nitrate, 26%) (Control plots) and nitrogenous fertilizer (ammonium nitrate, 26%) added with nitrification inhibitor (DMPP, Entec®) (DMPP plots). Plots (3 m x 3 m) were randomly set up in the fields. The fertilizer was applied at sowing and at 30 days after sowing. Soil N₂O fluxes were weekly measured using static chambers during spring and summer 2011. Air samples were collected every 10 minutes and N₂O concentrations in the samples were determined using gas chromatography. N₂O fluxes were calculated as: $V \Delta C/A \Delta T$ where V is chamber volume, A is the area covered by the chamber, and $\Delta C/\Delta T$ is the rate of gas concentration increase with sampling time interval. Differences between treatments were tested by the Student t -test.

3. Results & Discussion

Application of the nitrification inhibitor at sowing significantly reduced soil N₂O emission at both sites, although a lot of variability in emissions at control plots was observed (Figure 1). After the second application of fertilizer, N₂O fluxes from DMPP plots were similar to those from the control plots in Naples, whereas a peak and higher values of N₂O emission compared to control plots were observed at the Acerra site. The strong and significant reductions in N₂O emission at both sites was distinctly due to the nitrification inhibitor use. However, the different behaviour observed at two sites might be ascribed both to time of the year, since potato growing cycle was anticipated with respect to maize and soil-related factors such as texture, moisture and temperature. In fact, N₂O fluxes at Acerra site could be predicted by a multi-linear regression with soil moisture and soil temperature, whereas no relationship at Naples site could be found. In the first case, measurements were conducted during late winter and spring when substantial rainfall occurred; in the other case, the higher air evaporative demand and coarse texture lead to drier soil conditions. The higher N₂O emission peaks at the Naples site may also be related to the higher soil gas diffusion permittivity of the sandy soil.

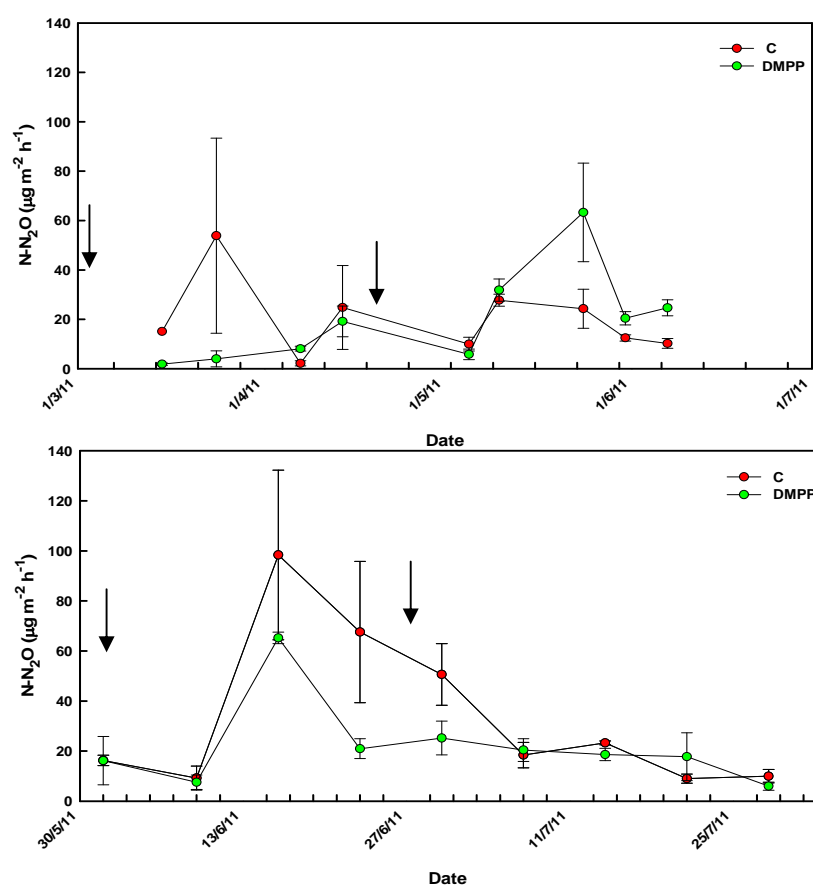

Figure 1. Soil N₂O emission from Acerra (upper panel) and Naples (lower panel) sites. Red circles: control plots; green circles: plots with DMPP. The arrows indicate the fertilizer application times.

4. Conclusion

Soil N₂O emissions of potato and maize crops grown in coarse textured soils of Southern Italy was reduced by the addition of a nitrification inhibitor to inorganic N fertilizers. The degree of reduction was dependent on soil moisture and temperature. Soil N₂O emission rates were different between the two sites, a likely effect of soil texture and time of the year, since potato growing cycle was anticipated with respect to maize.

References

- Pfab, H., Ruser, R., Palmer, I., Fiedler, S., Buegger, F. and Muller, T. 2009. N₂O Emissions from a high N-Input system as influenced by fertilizer amount and type. In: Grignani C, Acutis M, Zavattaro L, Bechini L, Bertora C, Marino Gallina, P, Sacco, D (eds) Proceedings of the 16th Nitrogen Workshop- Connecting different scales of nitrous use in agricultural. 28th June–1st July 2009, Turin, Italy, pp 197-198
- Jian-gang, H., Yong-li, Z., Hong-ying, B., Dong, Q., Jin-yu, C. and Chun-du, W. 2007. N₂O emission under different moisture and temperature regimes. *Bull Environ Contam Toxicol* 78, 284-287.
- Weiske, A., Vabitsch, A., Olesen, J.E., Schelde, K., Michel, J., Friedrich, R. and Kaltschmitt, M. 2006. Mitigation of greenhouse gas emissions in European conventional and organic dairy farming. *Agr Ecosyst Environ* 112, 221-2321

Soil Organic Matter Priming: effect of labile Carbon on N mineralisation in Irish grassland soils

Murphy C.J.^{abc}, Baggs E.M.^a, Morley N.^a, Paterson E.^b, Schulte P.R.O.^c, Wall D.P.^c

^aSchool of biological Sciences, University of Aberdeen, AB24 3UU, Aberdeen, Scotland, UK

^bJames Hutton Institute, Craigiebuckler, AB15 8QH, Aberdeenshire, Scotland, UK

^cTeagasc, Environment, Soils and Land Use Research Department, Johnstown Castle, Wexford, Rep. of Ireland

1. Background & Objective

In Ireland, N management is based on a ‘one soil fits all’ philosophy for grassland which may not be the optimal approach. Ireland has a diverse range of soil types which in turn have a wide range of net N mineralisation values (56-220 Kg N ha⁻¹ yr⁻¹, O’Connell and Humphreys, 2005). The main aim of this study was to determine the underlying processes that control N-mineralisation by investigating and quantifying the limiting factors controlling N-mineralisation in different soil types. The objectives were (1) to assess if the addition of labile C to the soil results in an increase in mineralised N (C limitation) (2) to quantify the rate of mineralisation (¹²CO₂ efflux) and use this to predict the amount of N mineralized during an incubation period, and (3) to investigate if the relationship between C inputs (priming effect) and N mineralisation is similar for different soil types. This study will provide new information to better understand the N mineralisation process. This information may form the basis for the development of new soil-specific N-advice for grassland soils in Ireland which is critical for environmentally sustainable farming in the future.

2. Materials & Methods

Techniques developed by Paterson et al. 2009 and Davidson et al. 1991 were adapted to investigate and quantify the interaction of C and N. Soils of different chemical and physical characteristics were incubated in microcosms over a 14 day period. On day 0, ¹³C labelled glucose (3 atm%) and ¹⁵NH₄¹⁴NO₃ (30 atm%) was added to the microcosm. On days 1, 3, 8, and 14 samples were destructively harvested for ¹⁵N isotopic analysis (isotopic dilution) and mineral N analysis to quantify gross N mineralization from soil organic matter (SOM). On days 1, 3, 5, 8, 11, and 14 gas samples were taken for total CO₂ efflux and ¹³C isotope partitioning of soil CO₂ efflux into glucose and SOM-derived components.

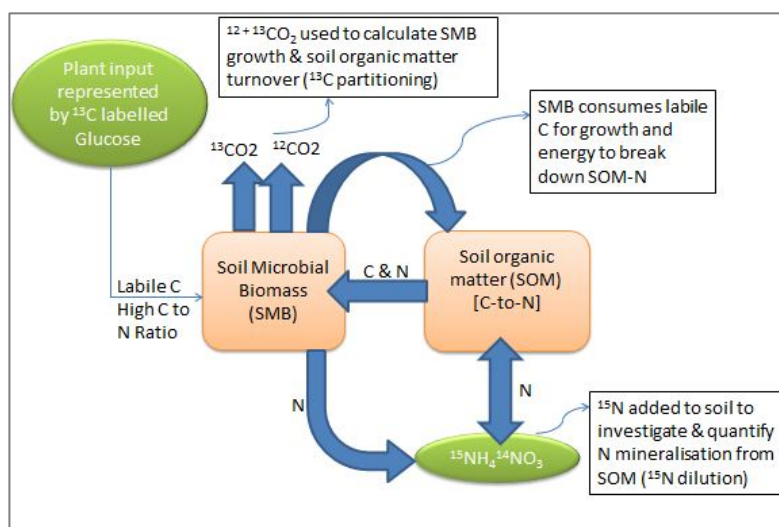

3. Results

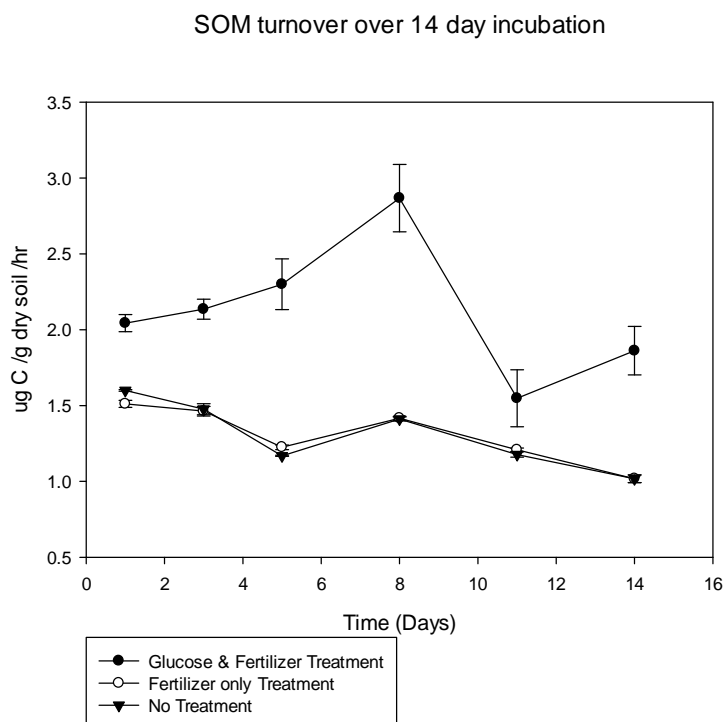

Figure 1 Shows an increase in SOM is observed when labile C is added to the soil.

Addition of labile carbon to soil resulted in an increase in N-mineralisation from soil organic matter. SOM-derived CO₂ efflux was concurrent with release of N from SOM (measured by ¹⁵N pool dilution). Consequently, labile plant-derived inputs to soil may be an important driver of soil N-cycling processes.

4. Conclusion

The results of these experiments provide valuable information about the factors controlling the N mineralisation processes that are not captured by 'standard' methods to assess potential N-mineralisation in contrasting soil types. This study provides a platform to conduct further research on the factors controlling the rate of N-mineralisation e.g. C-to-N ratio of SOM and the quality of plant C inputs.

5. References

- Davidson, E.A., H. S., Shanks, C.A. and Firestone, M.K. 1991. "Measuring gross nitrogen mineralisation, immobilization, and nitrification by ¹⁵N isotopic pool dilution in intact soil cores " J Soil Sci 42, 335-349.
- O'Connell KE and Humphreys, J. 2005. Accounting for nitrogen mineralisation in fertilizer nitrogen advice. *In*: Schulte RPO, Richards K, Finn J and Culleton N (eds.) The Science of Ireland's Rural Environment (1st Ed). Teagasc, ISBN: 1 84170 398 2
- Paterson, E., Midwood, A.J. and Millard, P. 2009. Through the eye of the needle: a review of isotope approaches to quantify microbial processes mediating soil carbon balance. *New Phytologist* 184, 19-33

Soil pH, and NO₃⁻ concentrations regulates the N₂O and N₂ emission from soil under anoxia

Senbayram, M.^a, Baken, L.^b, Budai, A.^b, Marton, L.^c, Lammell, J.^a

^aResearch Center Hanninghof, Yara International, 48249 Duellmen, Germany

^bInstitute of Plant and Environmental Sciences, Norwegian University of Life Sciences, As, Norway

^cResearch Institute for Soil Science and Agricultural Chemistry of the Hungarian Academy of Sciences, Hungary

1. Background & Objectives

The effect of soil pH on denitrification and its product stoichiometry is difficult to study because of limitations in measuring all products of denitrification such as NO and N₂. Nevertheless, numerous studies concluded that if the pH of a soil is low, denitrification rates decrease, but denitrification would emit more N₂O as a result of a higher N₂O/(N₂O+N₂) product ratio (Cuhel and Simek, 2011; Liu et al., 2010). It is assumed that, under acidic pH, the activity of N₂O reductase is lowered and the synthesis of new N₂O reductases is inhibited (Cuhel and Simek, 2011; Simek and Cooper 2002). In previous study, we showed that higher concentration of NO₃⁻ in soil may retard the reduction of N₂O to N₂ regardless of soil type (Senbayram et al., 2011). In this context, the positive effect of higher soil pH on the N₂O/(N₂O+N₂) product ratio of denitrification in soils with high NO₃⁻ content is still poorly understood and more research is needed to unravel quantitative relationships under well-defined conditions. In this study, we set up two incubation experiments, in order to test the short-term (24 h, in Exp.1) and the long-term (450 h, in Exp.2) effect of soil pH and NO₃⁻ concentration on denitrification rate and its product stoichiometry by measuring N₂O, NO as well as elemental N₂ in a soils with two pH levels (pH 4.1, and pH 6.9) collected from a long-term liming experiment.

2. Materials & Methods

The soils were collected in spring 2011 from a long-term liming experiment in Hungary. The experiment was established in 1962. Initial soil pH was 4.3 and soil pH values measured in 2011 were 4.1 and 6.9 in non-limed and limed soils respectively. The first incubation experiment was done to determine the short-term effects of NO₃⁻ concentration on potential denitrification and its N₂O/(N₂O+N₂) product ratios in high and low pH soils under complete anoxic conditions. Pre-wetted soils (low pH soil (**LpH**), and high pH soil (**HpH**)) were flooded and drained with 0.2, 2, 10, and 20 mM KNO₃ solution prior to the experiment. Then, the soil was immediately transferred to 120-ml serum flasks which were sealed and made anoxic by repeated evacuation and filling with He. Production of N₂O, NO and N₂ during batch incubation of soils was monitored for 24 h. Kinetics of NO, N₂O and N₂ accumulation during the incubation period were used to calculate the N₂O product share of denitrification and total denitrification rate. In Exp. 2, we used a continuous flow incubation system (under He) with larger vessels. Briefly, 1 kg moist soil was placed in PVC vessels then flooded and drained with 15 mM KNO₃ solution prior to the experiment to 20% gravimetric water content. All vessels were evacuated and filled with He, and then fresh He was directed through an inlet in the lid at a flow rate of 15 ml min⁻¹. Gas samples were analyzed twice a day for N₂O by ECD and for N₂ by TCD detectors (gas chromatography, GC-450 Varian Inc., USA) during 450 h of incubation.

3. Results & Discussion

In Exp. 1, denitrification rate in HpH increased in some proportion to the nitrate concentration within the entire concentration range (0.2-10 mM KNO₃) as seen in Figure 1A. In LpH, the rate of denitrification was essentially unaffected by nitrate concentration within the range 2-10 mM, but 24% lower with 0.2 mM NO₃⁻. With 10 mM KNO₃, the denitrification potential in HpH was 2 fold

higher than in LpH. We attributed lower denitrification rates below 10 mM KNO₃ in HpH and below 2 mM KNO₃ in LpH to the shortage of NO_x (lack of electron acceptor). The N₂O/(N₂O+N₂) product ratios of denitrification were consistently lower in HpH than LpH below N level of 10 mM KNO₃ (Figure 1 B). In situations where the organisms experience a shortage of NO_x, the relative rate of N₂O reduction (in relation to N₂O production) increases, thus low N₂O/(N₂O+N₂) product ratios of denitrification dominate (Senbayram et al., 2011). Therefore, higher N₂O/(N₂O+N₂) product ratios in LpH than HpH only with low level KNO₃ treatments, may be explained by the reduced demand of electron acceptors (low denitrification potential).

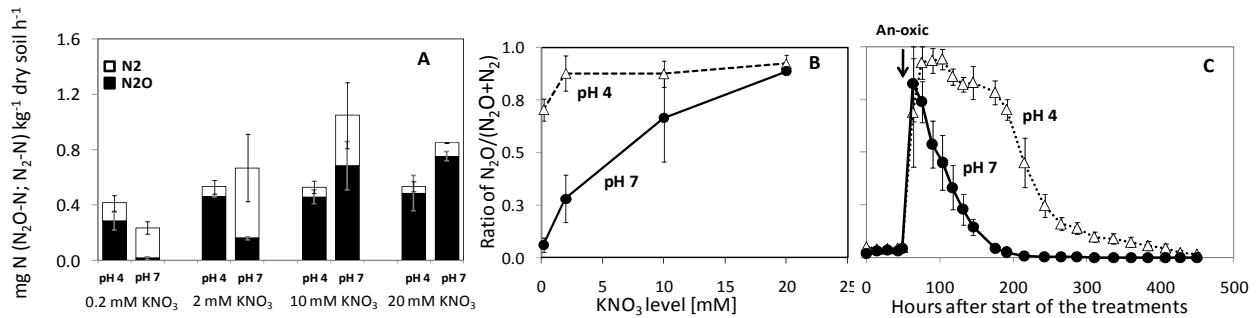

Figure 1. Effect of different KNO₃ concentrations on A) soil N turnover and emission rates (mg N kg⁻¹ dry soil h⁻¹), and B) the N₂O/(N₂O+N₂) product ratio of denitrification in long-term limed (pH 7) and non-limed control (pH 4) soils in Exp.1. The course of C) N₂O/(N₂O+N₂) product ratios of denitrification at N level of 15 mM KNO₃ in long-term limed (pH 7) and non-limed control (pH 4) soils in Exp. 2

In Exp. 2, denitrification rates were about two fold higher in HpH than in LpH. However, denitrification rates decreased gradually in HpH, whereas in LpH, they remained almost constant during the 450 hours of the experiment. The N₂O/(N₂O+N₂) product ratio of denitrification increased sharply with the start of anoxic period (Fig. 1B). In HpH the N₂O/(N₂O+N₂) product ratio decreased rapidly while in LpH it remained almost constant for around 100 hours and then decreased gradually towards zero. The results illustrate that the length of an anoxic spell is a third factor affecting the N₂O/(N₂O+N₂) product ratio of denitrification. This means that short anoxic spells will result in high N₂O/(N₂O+N₂) product ratio even in high pH soil. In low-pH soil however, the product ratio will be high for longer periods of anoxia.

4. Conclusion

The higher N₂O/(N₂O+N₂) product ratio of denitrification in acid soil compared to limed soil with low NO₃⁻ content, may be explained by lacking demand for electron acceptor. In addition, the effect of pH on N₂O/(N₂O+N₂) product ratio of denitrification is weakened by increasing nitrate concentration and long anoxic spells.

References

- Cuhel, J. and Simek, M. 2011. Proximal and distal control by pH of denitrification rate in a pasture soil. *Agriculture Ecosystem and Environment* 141, 230-233.
- Liu, B., Morkved, P.T., Frostegard, A. and Bakken L.R. 2010. Denitrification gene pools, transcription and kinetics of NO, N₂O and N₂ production as affected by soil pH. *FEMS Microbiology Ecology* 72, 407-417.
- Senbayram, M., Chen, R., Budai, A., Bakken, L. and Dittert, K. 2012. N₂O emission and the N₂O/(N₂O+N₂) product ratio of denitrification as controlled by available carbon substrates and nitrate concentrations. *Agriculture Ecosystem and Environment* 147, 4-12.
- Simek, M. and Cooper, J.E. 2002. The influence of soil pH on denitrification: progress towards the understanding of this interaction over the last 50 years. *European Journal of Soil Science* 53, 345-354.

Spatiotemporal variation in groundwater nitrate-N concentrations in two agricultural catchments

Mellander, P-E.^a, Melland, A.R.^a, Murphy, P.N.C.^a, Wall, D.^a, Shortle, G.^a, Jordan, P.^b

^aAgricultural Catchments Programme, Teagasc, Johnstown Castle, Environmental Research Centre, Co Wexford, Rep. of Ireland

^bSchool of Environmental Sciences, University of Ulster, Coleraine, N. Ireland

1. Background & Objectives

In order to mitigate anthropogenic nutrient transfers to surface waters in agricultural catchments there is a need to identify and quantify the transfer pathways and their influence on nutrient delivery to streams. It is further useful to understand how those pathways may vary in time and space and in their connection to nutrient sources, and the effect of temporal changes in water recharge and land management. The Agricultural Catchments Programme (ACP) aims to provide scientific evidence needed to support Irish agriculture in meeting the requirements of the Water Framework Directive (WFD). A 'nutrient transfer continuum' from source, through pathways, to delivery and impact in a water body receptor is used as a framework for evaluation of the European Union Nitrates Directive regulations and the Surface and Groundwater regulations. In agricultural river catchments with permeable soils nitrogen (N) loads tend to reflect that of near stream groundwater N concentrations of different strata, during both event and baseflow conditions, and sub-surface pathways are considered to be the major N transfer pathways throughout the year. In this paper we investigate possible links between N sources, groundwater and surface water as well as the implication of spatiotemporal variation for mitigation measures.

2. Materials & Methods

We present two years of N concentration data in streamwater and groundwater of different strata in two *c.* 10 km² agricultural catchments with permeable soils; one with arable land overlying slate bedrock (Co. Wexford, Ireland) and the other with intensively managed grassland on sandstone (Co. Cork, Ireland). Both catchments have two focused study sites (hill slope transects) chosen to represent the land use, soil type, geology and topography following conceptual modelling of existing data layers and geophysical surveying (including ground conductivity [EM 31 and EM 38], ground penetrating radar, 2D-resistivity and seismic refraction). Each site is equipped with three multilevel monitoring wells from which piezometric water levels are monitored and monthly water quality samples taken. In-stream N concentrations at the catchment outlet are measured *in-situ* on a sub-hourly basis using bankside analysers and discharge is monitored at rated non-standard flat-v weirs. Rainfall and weather parameters for estimating potential evapotranspiration are also being measured and nutrient and farm management practices are recorded at the field level.

3. Results & Discussion

Belowground hydrological pathways dominated in both catchments. In the grassland/sandstone catchment, hydrological pathways were mostly within the shallow bedrock, whereas the arable/slate had a relatively quick flow within the transition zone and shallow bedrock consisting of highly permeable weathered rock overlying competent rock and, therefore, showed a quicker response to rainfall in terms of water recharge and streamflow generation. Relatively high concentrations of N were found in groundwater, attributed to leaching of surplus soil nitrate-N (Figure 1). During a large flow event (summer, 2010) 95% of the total oxidised nitrogen was delivered to the stream by belowground pathways in both catchments. The grassland/sandstone catchment had higher nitrate-N concentrations and showed more seasonal and spatial variability. The highest nitrate-N

concentrations were found in the shallow strata of the near-stream zone. That zone was also more stratified in the grassland/sandstone than in the arable/slate and also more stratified compared to the uplands. In one hillslope of the grassland/sandstone catchment N was buffered in the near-stream zone, but this zone was bypassed with high nitrate-N content water from the uplands via subsurface drains. Effects of pasture reseeding (including mineralization of soil N) and slurry spreading in August 2010 were observed in the groundwater N concentration of the grassland/sandstone catchment but with a delay of *c.* five months (Figure 1). Effects of spatial and temporal differences in recharge were also observed in the groundwater N concentration due to localised more permeable subsoils (lenses of gravel) and due to seasonal difference in rainfall and evapotranspiration. Transport time will have an important role in determining the exposure time to biogeochemical processes that can attenuate N and the pathway will determine both the time-lag and biogeochemical processes that N is exposed to.

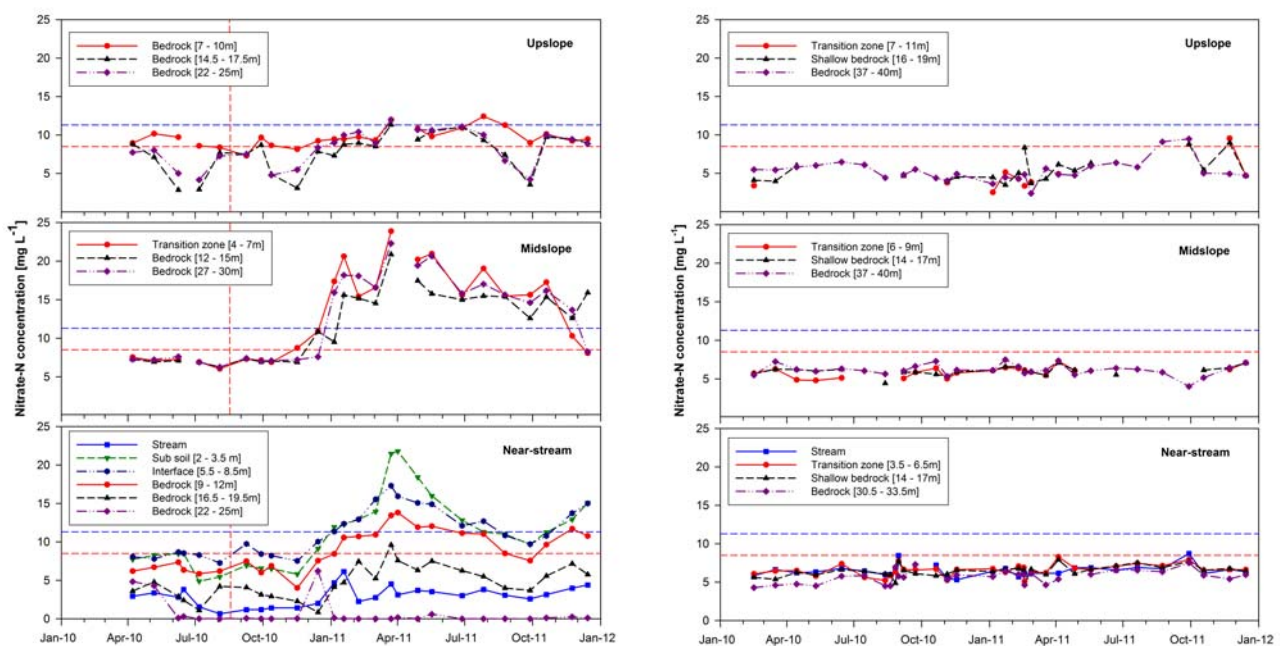

Figure 1. Nitrate-N concentration in groundwater of different strata in the upslope, midslope and near-stream of the grassland/sandstone catchment (left) and the arable/slate catchment (right). Irish drinking water standards ($\text{NO}_3\text{-N} = 8.5 \text{ mg L}^{-1}$) and MAC ($\text{NO}_3\text{-N} = 11.3 \text{ mg L}^{-1}$) are marked with horizontal red and blue dashed lines. Vertical red line marks a reseeding and slurry spreading event in August 2010.

4. Conclusion

Nutrient sources were connected to surface water *via* groundwater in both catchments. Land management, geology and weather were seen to influence the observed concentrations of N in groundwater, both spatially and temporarily. In selecting mitigation options it is important to understand the integrated effects on groundwater quality of spatiotemporal variability in recharge and land management. For effective characterization of nutrient transfer pathways in catchments with permeable soils we suggest including a chemical groundwater signature that represents the catchment for each geological strata.

Strategies to reduce nitrous oxide emissions after spread of pig slurry in no-till corn and wheat

Aita, C.^a, Schurman, J.^a, Giacomini, S.J.^a, Gonzatto, R.^a, Olivo, J.^a, Giacomini, D.A.^a

^a Department of Soil Science, Federal University of Santa Maria, Santa Maria, RS, Brazil.

1. Background & Objectives

It is relatively well documented in the literature that pig slurry may increase N₂O emissions because it contains inorganic N, microbial available sources of carbon, and water (Rochette et al., 2004; Chadwick et al., 2011). Additionally, the presence of straw in no-till conditions enhances availability of soluble carbon to heterotrophic decomposers that may create anoxic conditions, contributing to microbial production of N₂O after slurry spreading. In the South of Brazil, almost all of pig slurry is applied under no-till conditions. Therefore, it is necessary to quantify N₂O emissions in this situation and to develop strategies for its mitigation. The objective of this study is to evaluate the effect of split application of pig slurry and use of nitrification inhibitor as strategies to reduce N₂O emissions in no-till corn and wheat.

2. Materials & Methods

The study was conducted at the Research Farm of Soil Department, Federal University of Santa Maria, Brazil (29°43'S; 53°43'W; altitude: 105 m). The soil texture was loam consisting of 223 g clay, 379 g silt and 398 g sand kg⁻¹ in 0-20 cm layer, respectively. The experiment was carried out under no-till conditions for one year. The treatments used for both crops i.e. corn (*Zea mays* L.) (planting date: 12/11/2010) and wheat (*Triticum aestivum* L.) (planting date: 01/06/2011) were: without slurry (control), pig slurry fully applied before planting with and without Agrotain Plus (AP, containing 81% of the nitrification inhibitor dicyandiamide-DCD), pig slurry split (1/3 before planting and 2/3 in post emergence) with and without AP, and N-urea (1/3 before planting and 2/3 in post emergence). In pre-planting (no-split slurry application) the amounts of total N added was 168 kg ha⁻¹ (120 kg ha⁻¹ as N-NH₄⁺) in corn and 152 kg ha⁻¹ (102 kg ha⁻¹ as N-NH₄⁺) in wheat. In post-emergence (split application) the amounts of total N added was 109 kg ha⁻¹ (99 kg ha⁻¹ as N-NH₄⁺) in corn and 104 kg ha⁻¹ (71 kg ha⁻¹ as N-NH₄⁺) in wheat. Randomized complete block design with four replications was used. In situ N₂O fluxes were measured periodically by the static closed chamber technique. Gas samples were analyzed for N₂O concentration using a gas chromatograph (Shimadzu GC-2014 Greenhouse model).

3. Results & Discussion

Episodes of higher N₂O emission were transient and coincided with periods of no-split (pre-planting) and split (post-emergence) corn and wheat slurry application (Figure 1). Higher N₂O fluxes were observed in split slurry in corn and in no-split slurry in wheat, both without nitrification inhibitor. Accumulated N₂O emission was not affected by the split application of pig slurry in corn, but this strategy of slurry use significantly reduced N₂O emission in wheat (Table 1). The use of dicyandiamide (DCD) with pig slurry reduced N₂O emission in 14.2 % in corn and 125 % in wheat.

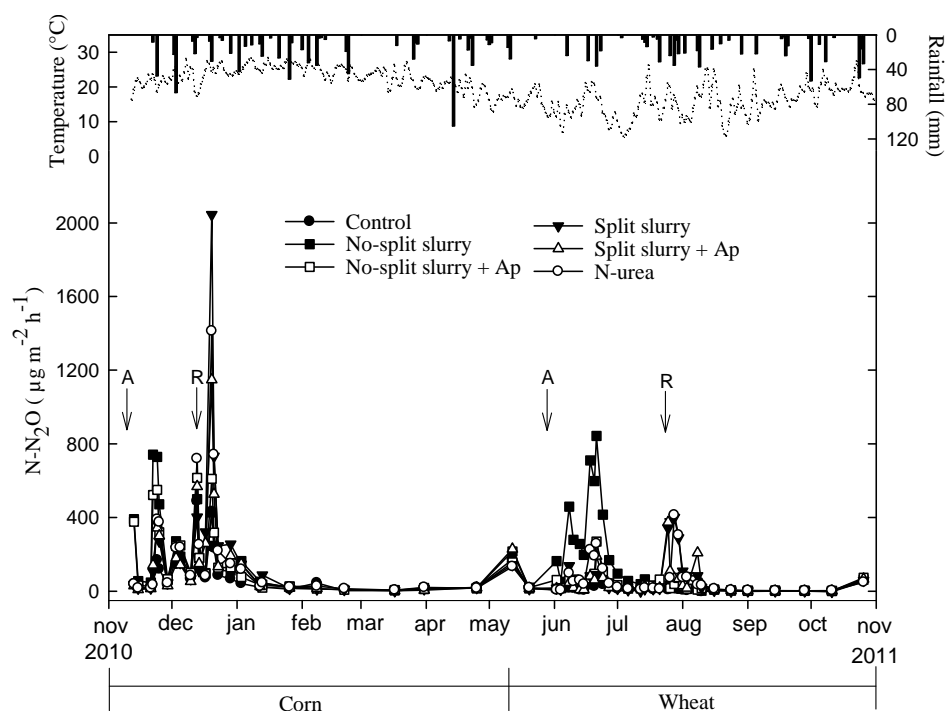

Figure 1. Temporal variation of rainfall and temperature and soil-surface N_2O flux from a soil cropped to no-till corn and wheat amended with N-urea, non-split and split pig slurry, with and without nitrification inhibitor. Ap=Agrotain plus, containing 81% of dicyandiamide (DCD); A=Application of pig slurry; R=Reapplication of pig slurry.

Table 1. Annually cumulated $N-N_2O$ emission with the use of N-urea, non-split and split pig slurry in no-till corn and wheat.

Treatments	Corn		Wheat	
	$N-N_2O$ ($kg\ ha^{-1}$)	$N-N_2O$ (% of added N)	$N-N_2O$ ($kg\ ha^{-1}$)	$N-N_2O$ (% of added N)
Control	2.33	-	0.34 a	-
No-split slurry	3.93	0.95	2.91 c	1.69 b
No-split slurry + Ap ¹	3.45	0.66	0.90 ab	0.37 a
Split slurry	4.24	1.15	1.44 b	0.76 a
Split slurry + Ap	3.70	0.83	1.13 ab	0.55 a
N-urea	3.90	1.17	1.39 b	0.94 a

¹ AP= Agrotain Plus that contain 81% of the nitrification inhibitor dicyandiamide (DCD)

4. Conclusion

This work showed that split application of pig slurry and the use of the nitrification inhibitor dicyandiamide (DCD) are potential strategies to reduce N_2O emissions in no-till corn and wheat.

References

- Chadwick, D., Sommer, S., Thorman, R., Figueiro, D., Cardenas, L., Amon, B., Misselbrook, T. 2011. Manure management: Implications for greenhouse gas emissions, *Animal Feed Science and Technology* 166-167, 514-531.
- Rochette, P., Angers, D.A., Chantigny, M.H., Bertrand, N., Côté, D. 2004. Carbon dioxide and nitrous oxide emissions following fall and spring applications of pig slurry to an agricultural soil, *Soil Science Society of America Journal* 68, 1410-1420

Study of the key factors which influence N₂O and CO₂ emissions in a fertigation cropping system under Mediterranean climate

Ábalos, D.^a, Sánchez-Martín, L.^a, García-Torres, L.^a, Téllez, A.^a, García-Marco, S.^a, Sanz-Cobeña, A.^a, Vallejo, A.^a

^aETSI Agrónomos, Technical University of Madrid, Ciudad Universitaria, 28040 Madrid, Spain

1. Background & Objectives

For a summer crop in the Mediterranean climate, irrigation management and type of fertilizer are two of the most important factors influencing emissions of greenhouse gases (GHG) from irrigated agricultural soils. Localized irrigation techniques such as drip irrigation (DI) influence soil moisture, producing wet and dry areas and, therefore, influence the processes responsible for the production and consumption of GHG (Sanchez-Martin et al., 2008). Irrigation frequency, together with high evapotranspiration during summer season, influence soil microbial activity and, therefore, emissions of GHG. A targeted combination of N fertilizer and irrigation frequency could help decrease GHG emissions, leading to a more sustainable cropping system. A field experiment was carried out in summer 2011 under a melon crop in order to evaluate the emissions of two of the most important GHG, nitrous oxide (N₂O) and carbon dioxide (CO₂), in relation to irrigation frequency and type of fertilizer.

2. Materials & Methods

A field experiment was carried out at 'El Encín' field station in Madrid (40° 32'N; 3° 17' W) on a melon crop. Eighteen plots (20 m²) were selected and arranged in a randomized complete block design with 3 N treatments x 2 irrigation frequencies x 3 repetitions. Nine of them were irrigated 1 day per week (low frequency; LF) and the other nine were irrigated 7 days per week (high frequency; HF). N treatments were applied under both irrigation frequencies: calcium nitrate (NLF; NHF), urea (ULF; UHF) and control plots without any N application (CLF; CHF). N fertilisers were applied weekly from 19th July to 19th September by fertigation, at a total rate of 125 kg N ha⁻¹. All melons were harvested in September. N₂O and CO₂ samples were taken twice a week during the whole experimental period (c. 2 months), using static chambers (3.1 l). Gas samples were analyzed by gas chromatography using an electron capture detector for N₂O and a flame ionization detector with methanizer for CO₂. Soil moisture and mineral N (NH₄⁺ and NO₃⁻) were measured using the methodology described in Sanchez-Martin et al. (2008). Soil samples were taken coinciding with gas sampling days. Differences between treatments in the cumulative emissions were analysed using analysis of variance (ANOVA, *P* < 0.05).

3. Results & Discussion

Application of nitrate fertilizer reduced net N₂O emissions by c. 74% compared to the urea fertilized plots. Taking into account that urea fertilization significantly increased the soil NH₄⁺ content, our results suggest that nitrification was a major source of these higher emissions.

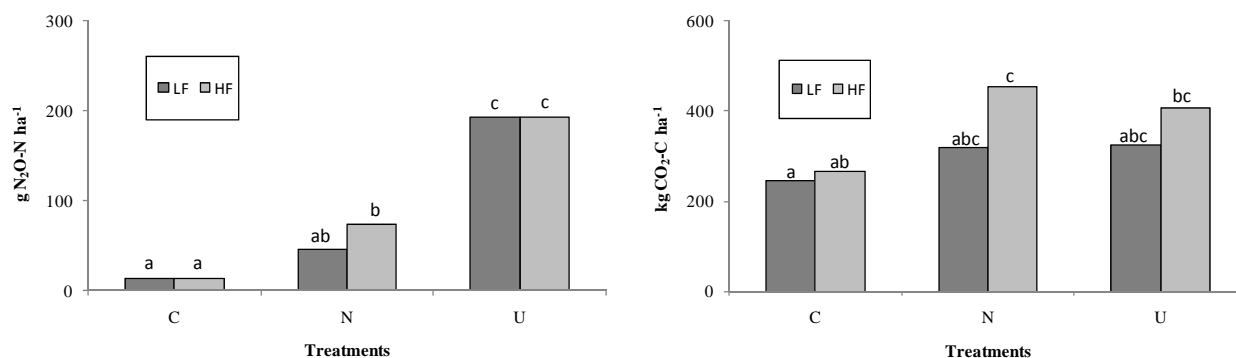

Figure 1. Cumulative N₂O and CO₂ emissions during the experimental period.

Irrigation management had no significant effect on N₂O emissions, however, the low frequency treatment reduced net CO₂ emissions by c. 35%. This effect may be partially attributed to decreased ecosystem respiration due to the lower temporal water availability of this treatment (Meijide et al., 2010).

4. Conclusion

Based in our results, replacing NH₄⁺ fertilizer (urea) with NO₃⁻ fertilizer could be an option to mitigate N₂O emissions in the Mediterranean climate. Additionally, lowering the irrigation frequency may decrease CO₂ emissions.

References

- Meijide, A., Cárdenas, L., Sánchez-Martín, L. and Vallejo, A. 2010. Carbon dioxide and methane fluxes from a barley field amended with organic fertilizers under Mediterranean climatic conditions. *Plant and Soil* 328, 353-367.
- Sánchez-Martín, L., Arce, A., Benito, A., García-Torres, L. and Vallejo, A., 2008. Influence of drip and furrow irrigation systems on nitrogen oxide emissions from a horticultural crop. *Soil Biology and Biochemistry* 40, 1698-1706.

Synergetic leaching model based on pathway and pressure factors

Kuzmanovski, V.^a, Džeroski, S.^a, Schulte, R.P.O.^b, Debeljak, M.^a

^aDepartment of Knowledge Technologies, Jozef Stefan Institute, Jamova 39, 1000 Ljubljana, Slovenia

^bTeagasc, Johnstown Castle, Environmental Research Centre, Co Wexford, Rep. of Ireland

1. Background & Objectives

The implementation of the Nitrates Action Programme in 2006 has led to a reduction of agricultural nutrient pressures on surface waters and groundwater in Ireland. This has coincided with an apparent halt – or even tentative reversal – of the historic deterioration of water quality over time. However, the current implementation of the Water Framework Directive poses more stringent challenges to minimising nutrient loss from agriculture, particularly in areas where “high status” water quality must be preserved. Maintenance of “high status” water quality requires customised mitigation strategies that account for local geo-climatic conditions and farming systems. Such strategies require an in-depth quantitative insight into the interactions between nutrient pressures and transport mechanisms. In this study we use data mining methodology to find the synergetic patterns of the interactions between pressure (soil mineralization, drought and grass growing season) and pathway (soil drainage, net rainfall and rainfall intensity) attributes which impact leaching of nitrogen and phosphorus to water.

2. Materials & Methods

Analysis were done on a dataset that contains data for the following pressure factors: phosphorus and nitrogen field’s input, duration of grass growing season, soil moisture deficit (which represents the soil water dynamics) and pathway factors: soil drainage, net rainfall and the number of intense drainage events (Schulte et al., 2006). The dataset contains 352 records, each representing one grid cell of 10 x 10 km (out of 798 grid cells into which Ireland has been divided). To find interactions among attributes that might have synergetic effects on nutrients transfer to water, we used decision trees as a flexible and robust data mining method, ideally suited for the analysis of complex ecological data. They can deal with nonlinear relationships, high-order interactions and missing data, and in the same time are simple to understand and give easily interpretable results (De’ath and Fabricius, 2000). Decision trees predict the value of one or several dependent variables (targets) from a set of independent variables (attributes). We modelled the concentration of nitrogen and phosphorus in water individually, as well as simultaneously, where we predicted the concentrations of both nutrients at once. Models for predicting the concentration of individual nutrients were learned with model trees in the Weka data mining suite (Witten & Frank 2005) while the simultaneously predictions of both nutrients were made with predictive clustering trees (Blockeel et al., 1998) implemented in the Clus data mining system (Blockeel and Struyf, 2002).

3. Results & Discussion

Soil moisture deficit (SMDmax) has been selected as the most important attribute because it appears at the top most position of all induced decision tree models. The model with the best validation performance was the model for predicting nitrogen concentration (Fig. 1, Table 1) (correlation coefficient of 10-fold cross validation is 0.799), while the worst performance was observed for the phosphorous model (correlation coefficient of 10-fold cross validation is 0.475).

Table 1. Nitrogen concentration for different sections of the nitrogen model (Figure 1)

LM1	LM2	LM3	LM4	LM5	LM6	LM7	LM8
0.7733	1.0522	1.5704	2.7285	6.0889	8.6308	11.4505	14.3184

The model for predicting both, nitrogen and phosphorus at the same time, showed good prediction performance with the correlation coefficient of 10-fold cross validation of 0.874 for nitrogen and 0.669 for phosphorus.

Figure 1. Regression tree for predicting the nitrogen concentration in water.

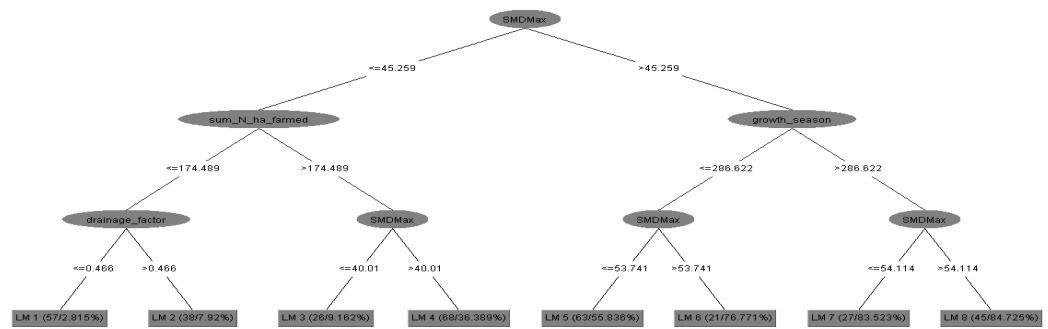

The structure of the nitrogen model (Figure 1) shows that strongly correlated attributes for estimating nitrogen concentration in water are soil moisture deficit (“SMDMax”), field’s input of nitrogen (“sum_N_ha_farmed”), drainage factor (“drainage_factor”) and grass growing season (“growth_season”). Hence, when the soil moisture deficit is less than 45.259 mm (wet soil), low field’s input of nitrogen (less than 174.489 kg ha⁻¹) and low drainage factor (poorly drained field) lead to minimal concentration of nitrogen (LM1: 0.7733 mg L⁻¹) which is smaller than in case of moderate or well-drained soil (LM2: 1.0522 mg L⁻¹). The theory says that smaller soil moisture deficit “allow” field’s input of nitrogen to control the concentration in water (Schulte et al., 2006), on the other hand, when soil is well-drained then water has open paths to go deeper, collecting the accumulated nitrogen in the soil, otherwise the water will stay in the soil and it will stop nitrogen leaching under the root zone. The Table 1 shows the predicted concentrations of nitrogen in water for different combinations of the attributes included in the model. Note that each path in the decision tree can be interpreted as a rule that explains the phenomena leading to the correct conclusion. It should be noted that the performance measures of the phosphorus model shows that the used attributes cannot predict its concentration in water and some additional attributes should be included into database.

4. Conclusion

Our approach has identified synergetic interactions among the attributes describing the pressure of nutrients loss and transport pathways. Discovered patterns can be used for formulating further mitigation strategies which can make significant contributions to the reduction of water pollution from agriculture. The proposed methodology could be applied also to less aggregated data which would enable identification of areas with different risks of nutrients losses (Debeljak et al., 2010).

References

- Blockeel H., Raedt L. De, and Ramon J. 1998. Top-down induction of clustering trees, Proceedings of the 15th International Conference on Machine Learning (Shavlik, J., ed.), pp. 55-63,
- Blockeel, H. and Struyf, J. 2002. Efficient algorithms for decision tree cross-validation. *Journal of Machine Learning Research*, 3:621-650.
- Witten, I.H. and Frank, E. 2005. *Data Mining: Practical Machine Learning Tools and Techniques*. Morgan Kaufmann, San Francisco, CA, USA, second edition.
- De’ath G., Fabricius K.E., 2000. Classification and regression trees: A powerful yet simple technique for ecological data analysis. *Ecology* 81, 3178-3192.
- Debeljak, M., Kocev, D., Towers, W., Jones, M., Griffiths, B. and Hallett P 2009. Potential of multi-objective models for risk-based mapping of the resilience characteristics of soils: demonstration at a national level. *Soil Use & Man*, 25:66-77.
- Schulte R.P.O., Richards K., Daly K., Kurz I., McDonald E.J. and Holden N.M. 2006. Agriculture, meteorology and water quality in Ireland: A regional evaluation of pressures and pathways of nutrient loss to water. 17, 117-133.

Terrestrial carbon and nitrogen losses and indirect greenhouse gas emissions via groundwater

Jahangir, M.M.R.^{a, b}, Johnston, P.^b, Khalil, M.I.^c, Hennessy, D.^d, Humphreys, J.^d, Fenton, O.^a, Richards, K.G.^a

^aTeagasc Environment Research Centre, Johnstown Castle, Co. Wexford, Rep. of Ireland

^bDepartment of Civil, Structural & Environ. Engineering, The University of Dublin, Trinity College, Dublin 2, Ireland

^cEnvironmental Protection Agency, Johnstown Castle Estate, Co. Wexford, Ireland

^dTeagasc, Animal and Grassland Research and Innovation Centre, Moorepark, Fermoy, Co. Cork, Ireland

1. Background & objectives

Reactive nitrogen (N) emissions to waters greatly contribute to groundwater pollution, freshwater and coastal eutrophication, algal bloom and hypoxia. While most research has focused on direct emissions, indirect N₂O emissions via groundwater is a significant, but very poorly understood component of the global N₂O budget (Clough et al., 2007). Groundwater is also an important vector of indirect emissions of CO₂ and CH₄ (Minamikawa et al., 2010) with significant discharges to surface waters and effects on aquatic biogeochemistry. The dynamics of dissolved C and N in groundwater is a key ‘‘missing piece’’ in our understanding of global C and N balances. This research aimed to (i) measure the amount of dissolved C and N losses from terrestrial ecosystems to the aquatic ecosystems via groundwater, and (ii) estimate the contribution of indirect emissions of GHG to the atmosphere.

2. Materials & Methods

The investigation were carried out at two low permeability (L: L1, Johnstown Castle; L2, Solohead) and two high permeability (H: H1, Oak Park; H2, Dairygold) sites in Ireland. Among the sites, L1, L2 and H2 were grassland and H1 was arable. Groundwater sampling was carried out monthly between Feb, 2009 and Jan, 2011 for hydrochemistry and dissolved gases. For dissolved N₂O, CO₂ and CH₄, samples were degassed using *He* headspace extraction technique and analysed by gas chromatography. The samples for N₂ were analysed in a high precision membrane inlet mass spectrometer (MIMS). Prior to groundwater sampling watertable (WT) depth was measured using an electronic dip meter. A water balance was used to calculate the effective rainfall (ER).

3. Results & Discussion

Total N input was 300, 213, 150 and 297 kg N ha⁻¹, respectively at L1, L2, H1 and H2 sites. Among the grassland sites, the number of livestock units (LU) was lower at L2 (2.0 LU) than L1 (2.2 LU) and H2 (2.2 LU). Rainfall was well above average (130-140%) in 2009 and below average (87-90%) in 2010 across sites. The period of ER at the L sites was longer than the H sites (Table 1). The annual WT fluctuation ranges were 1.9, 0.7, 3.5 and 5.3 m below ground level.

Table 1. Annual rainfall, potential evapotranspiration (PET), actual evapotranspiration (AET) and effective rainfall (ER) data at four experimental sites between 2009 and 2010

Hydrologic events	L1		L2		H1		H2	
	2009	2010	2009	2010	2009	2010	2009	2010
‡P (mm)	1452	947	1403	879	1167	759	1293	869
‡PET (mm)	632	633	681	686	713	718	694	700
‡AET (mm)	615	562	643	553	630	518	620	543
‡ER (mm)	836	385	759	326	537	241	673	326
No. of days ER occurred	211	168	200	45	83	43	105	50
Portion of P as ER (%)	57	41	54	41	46	32	52	38

‡P: precipitation, PET: potential evapotranspiration, AET: actual evapotranspiration and ER: effective rainfall

Mean N_2O -N conc. over the two years differed significantly between sites ($p < 0.001$) (Figure 1). Dissolved CO_2 conc. was significantly higher at grassland than arable sites. Mean CH_4 conc. was higher at the L sites than the H sites. Mean dissolved N ($\text{DN} = \text{NO}_3^- \text{-N} + \text{NO}_2^- \text{-N} + \text{N}_2 \text{-N} + \text{N}_2\text{O-N} + \text{NH}_4^+ + \text{dissolved organic N}$) loads in groundwater over the two years accounted for 12, 8, 38, and 27% of the surface N input. The major fraction of DN was $\text{NO}_3^- \text{-N}$ (81-92%) at H sites and N_2 (46-77%) at L sites. Loads of dissolved C (dissolved organic C (DOC)+ CO_2 + CH_4) discharged ranged from 78-344 kg ha^{-1} at L and 30-217 kg C ha^{-1} at H sites.

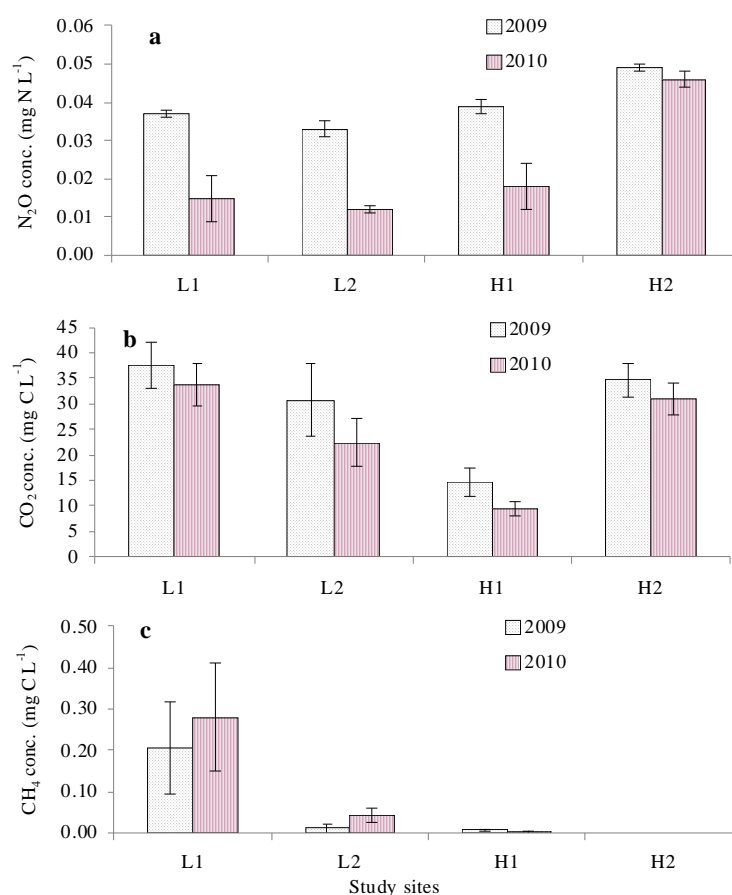

Figure 1 (a) N_2O , (b) CO_2 and (c) CH_4 conc. in groundwater at four experimental sites (mean \pm SE, $n=24$)

4. Conclusions

Estimation of losses of dissolved carbon and nitrogen via groundwater is important to reduce the uncertainties in the terrestrial C and N balances. Quantifying dissolved N_2O , CO_2 and CH_4 in groundwater beneath an agricultural system is of huge importance for global GHG budgets.

References

- Clough T.J., Addy K., Kellogg D.Q., Nowicki B.L., Gold, A.J. and Groffman P.M. 2007. Dynamics of nitrous oxide in groundwater at the aquatic-terrestrial interface, *Global Change Biology* 13, 1528-1537.
- Minamikawa K., Nishimura S., Sawamoto T., Nakajima Y. and Yagi K. 2010. Annual emissions of dissolved CO_2 , CH_4 , and N_2O in the subsurface drainage from three cropping systems, *Global Change Biology* 16, 796-809.

The complexity of the recharge processes and their effect on seasonal variations of nitrate concentration in shallow groundwater and streams: observations and modeling

L. Ruiz^{a,b}, M. Rouxel^{a,b}, Gascuel-Oudou^{a,b}, L. Aquilina^c, A. Aubert^{a,b}, M. Faucheux^{a,b}, P. Merot^{a,b}, J. Molenat^{a,b,e}, M. Sebilo^d

^a INRA, UMR1069, Sol Agro et hydrosystème, F-35000 Rennes.

^b Agrocampus Ouest, UMR1069, Sol Agro et hydrosystème, F-35000 Rennes.

^c Université de Rennes 1, CNRS, UMR 6118, Géosciences Rennes, F-35000 Rennes.

^d UPMC Univ Paris 06, UMR Bioemco, 4 place Jussieu, 75252 Paris Cedex 05, France

^e INRA, UMR, LISAH, F-34000 Montpellier

1. Background & Objectives

Shallow groundwater that develops on hillslopes is the main compartment in headwater catchments for flow and solute transport to rivers. Although spatial and temporal variations in its chemical composition are reported in the literature, there is no coherent description of the way these variations are organized, nor is there an accepted conceptual model for the recharge mechanisms and flows in the groundwater involved. This study is a part of ACASSYA project **ANR-08-STRA-01** (<http://www.inra.fr/acassya>) described by Durand et al (2012, this meeting).

2. Materials & Methods

We instrumented two intensive farming and subsurface dominant catchments located in Oceanic Western Europe (Kervidy-Naizin and Kerbernez, Brittany, France), two headwater catchments included in the Observatory for Research on Environment AgrHyS (Agro-Hydro-System) and a part of the French Network of catchments for environmental research (SOERE RBV focused on the Critical Zone). These systems are strongly constrained by anthropogenic pressures (agriculture) and are characterized by a clear non-equilibrium status.

- On Kervidy- Naizin, a daily monitoring of the nitrate concentrations in the stream and a three monthly monitoring of the nitrate concentrations of the shallow ground water, over 10 years, is now available. This first set of data is dedicated to the analysis of the intra and inter-annual variations of the nitrate concentrations and its relationship with those in the shallow groundwater.
- On Kerbernez, a network of 42 nested piezometers was installed along a 200 m hillslope allowing water sampling along two transects in the permanent water table as well as in what we call the “fluctuating zone”, characterized by seasonal alternance of saturated and unsaturated conditions (Legout et al., 2007). Water composition was monitored at high frequency (weekly) over a 3-year period for major anion composition and over a one year period for detailed ¹⁵N, CFC, SF₆ and other dissolved gases. This second set of data is dedicated to the analysis of the recharge process.

3. Results & Discussion

The results on Kervidy-Naizin shows that the concentrations in the stream increases abruptly at the beginning of the recharge period, correlatively with a hydraulic gradient, then level off during the wet and spring, despite the decrease of the hydraulic gradient. This hysteresis pattern along the water cycle can be explained by spatial variations of the nitrate concentration in the groundwater along the hillslope, which decreases from upslope to downslope, and the spatio-temporal variations of the hydraulic gradients. The results on Kerbernez which focus on the recharge processes show that local processes can also be involved to explain the spatiotemporal variations of the stream concentrations (Rouxel et al., 2011). They shows that (i) the anionic composition in water table fluctuation zone varied significantly compared to deeper portions of the aquifer on the hillslope, confirming that this layer constitutes a main compartment for the mixing of new recharge water and old

groundwater, (ii) seasonally, the variations of ^{15}N and CFC are much higher during the recharge period than during the recession period, confirming the preferential flow during early recharge events, (iii) variations of nitrate ^{15}N and O18 composition was suggesting any significant denitrification process in the fluctuating zone, confirming the dominance of the mixing processes in the fluctuating zone, (iv) deeper parts of the aquifer exhibited seasonal variations with structured hysteretic patterns, suggesting that mixing process also occurred at greater depths and (v) these hysteretic patterns were damped from upslope to downslope, indicating an increased influence of lateral flow downslope. These results indicate that we have to change the way we model subsurface dominant catchment, taken into account the degree of saturation of the catchment, the mixing processes varying from the surface to depth, and upslope to downslope. First modeling approaches considering a mixing process, in addition to the convection/dispersion model, are able to better fit the chemical variations of the anions in the shallow groundwater.

4. Conclusion

As of now, we can deduce these results that the residence times deduced from end member approaches considering the groundwater as homogeneous lumped reservoir are likely to be highly underestimated. Instrumented observatories including spatial and temporal monitoring of the hillslope groundwater are required to understand the anthropogenic and environmental processes and their interactions, to model and predict the effect and the response time of such systems under different constraints.

References

- Durand, P, Ruiz, L, Vertès, F, Delaby, L, Moreau, P, Hubert-Moy, L. and Gascuel-Oudou, C. 2012. A framework for designing and evaluating nitrogen-efficient farming systems at the catchment scale by combining process studies, agro-hydrological integrated modelling and participatory approach into an iterative process. This meeting.
- Legout, C., Molenat, J., Aquilina, L., Gascuel-Oudou, C., Faucheux, M., Fauvel, Y. and Bariac T. 2007. Solute transfer in the unsaturated zone-groundwater continuum of a headwater catchment. *Journal of Hydrology*. 332 (2-4), 427-441.
- Rouxel, M., Molenat, J., Ruiz, L., Legout C., Faucheux, M. and Gascuel-Oudou, C. 2011. Seasonal and spatial variation in groundwater quality at the hillslope scale: study in an agricultural headwater catchment in Brittany (France). *Hydrological Processes* 25, 831-841.

The effect of a mustard cover crop on groundwater denitrification

Jahangir, M.M.R.^{a,b}, Minet, E.^a, Johnston, P.^b, Coxon, C.E.^c, Hackett R.^d, Richards, K.G.^a

^aTeagasc Environment Research Centre, Johnstown Castle, Co. Wexford, Ireland

^bSchool of Engineering; ^cSchool of Natural Sciences, Trinity College Dublin, Dublin 2, Ireland

^dTeagasc Oak Park, Co. Carlow, Ireland

1. Background & Objectives

Groundwater contamination by nitrate (NO_3^-) is a cause of concern for the environment. Aquifer discharge of NO_3^- into streams, lakes, rivers and coastal transitional waters can increase the risk of eutrophication in surface waters. Leached NO_3^- may also contribute to global warming via indirect nitrous oxide (N_2O) emissions. Agriculture accounts for most of Ireland's N_2O emissions and mitigation techniques are required to reduce emissions. The research objective was to investigate the impact of a cover crop (mustard) on the in situ denitrification rates and the N_2O mole fractions ($\text{N}_2\text{O}/\text{N}_2\text{O}+\text{N}_2$) measured in shallow groundwater under spring barley cropping.

2. Materials & Methods

In situ denitrification rates were measured in March 2011 using a push-pull method (Addy et al., 2002) in a shallow sand/gravel aquifer (water table < 4 m below ground level) underneath an arable field of well drained soil (sandy loam) at Oak Park Research Centre. Two treatments within a spring barley system have been cultivated since 2006: (1) mustard and (2) no cover crop, as part of a larger experiment on the effect of over-winter green cover on nitrate leaching losses (Premrov et al., 2011). Three wells (PVC pipe; 0.03 m i. d. and 1.0 m screen section) were installed in each plot. The push-pull method consisted of collecting groundwater from each well, amending it with ^{15}N -enriched NO_3^- and a conservative tracer (bromide), injecting the solution in the aquifer ("push"), incubating in situ for several hours (4 hours) and pumping out ("pull"). "Pushed" and "pulled" groundwater solutions were analysed for dissolved N gases (N_2O and N_2) and ions (NO_3^-), dissolved organic carbon (DOC), other physico-chemical parameters (SO_4^{2-} , Eh, pH, electrical conductivity-EC) and stable isotope ratios ($^{15}\text{N}/^{14}\text{N}$ in N_2O and N_2). Denitrification rates were calculated according to equations from Mosier and Klemetsson (1994). Non-parametric Mann-Whitney U tests were performed to determine significant differences ($p < 0.05$) between both cropping systems.

3. Results & Discussion

At the time of the experiment, groundwater NO_3^- -N concentration was lower and DOC concentration higher (Table 1) in the cover compared to no cover treatments ($p < 0.05$). Other hydrochemistry (DO, Eh, pH, EC and SO_4^{2-}) were statistically similar under both treatments.

Table 1 Hydrochemical properties in two differently managed arable plots (mean \pm SE; n=3)

Treatment	NO_3^- -N	DOC	DO	SO_4^{2-}	Eh	pH	EC
	-----mg L ⁻¹ -----				(mV)		$\mu\text{S cm}^{-1}$
Spring Barley - cover crop	13.6 \pm 2.6a	1.3 \pm 0.1a	10.2 \pm 0.2a	23.9 \pm 2.1a	185 \pm 5.0a	7.8 \pm 0.1a	441 \pm 17a
Spring Barley - no cover crop	20.2 \pm 4.5b	0.9 \pm 0.1b	10.7 \pm 0.4a	20.5 \pm 1.7a	190 \pm 5.8a	8.0 \pm 0.1a	411 \pm 16a

Means with the same letters within each column do not differ significantly

Mean N_2O production rates (Figure 1a) were similar ($p > 0.05$) in both treatments (2.27 and 1.97 ng N kg soil⁻¹ d⁻¹). In contrast, N_2 production rates in the cover crop treatment were 7.61 $\mu\text{g N kg soil}^{-1}$ d⁻¹ whereas there was no N_2 detected in the absence of a cover crop (Figure 1b). As a result, the

mean total denitrified N rates ($\text{N}_2\text{O}+\text{N}_2$) in the spring barley plots with and without cover crop were 7.61 and 0.002 $\mu\text{g kg soil}^{-1} \text{d}^{-1}$ respectively (equivalent to 0.033 and 0.0001 $\text{mg N L}^{-1} \text{d}^{-1}$). The $\text{N}_2\text{O}/\text{N}_2\text{O}+\text{N}_2$ molar ratio was approximately 0.001 with cover crop, whereas it was about 1 without cover crop.

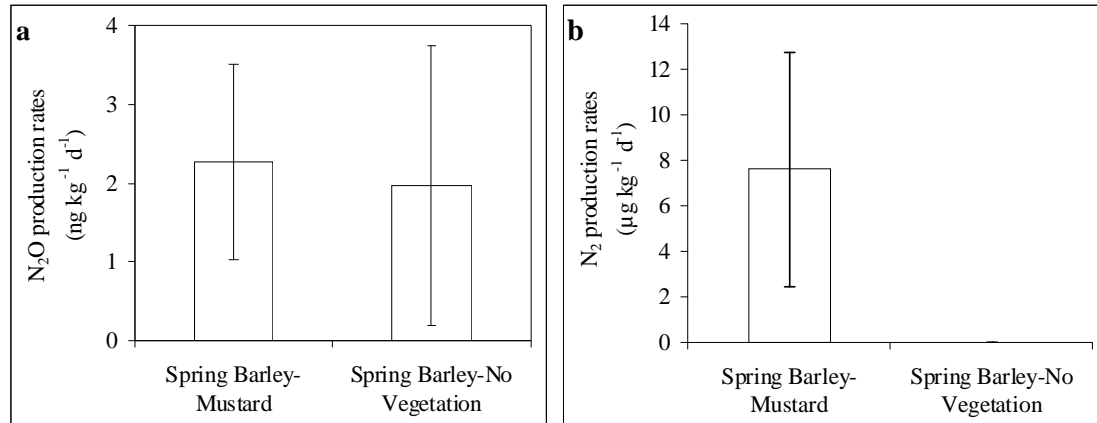

Figure 1 Groundwater N_2O (a) and N_2 (b) production rates in shallow groundwater under spring barley cropping with a mustard cover crop or no cover crop (no vegetation).

Previous results from this site showed reduced groundwater NO_3^- -N (Premrov et al., 2011) and indicated higher groundwater DOC under the mustard cover crop (Premrov et al., 2009). Results from the present study suggest that the introduction of a mustard cover crop in spring barley tillage areas could also substantially enhance NO_3^- reduction via denitrification without significantly increasing N_2O emissions. The observed enhanced denitrification under the cover crop may result from the higher groundwater DOC but the mechanism under highly aerobic conditions is unclear and may relate to aquifer anaerobic micro sites. Although the total groundwater denitrification rates are low, when combined with aquifer residence times (up to 5.6 years estimated by Fenton et al. (2009)), denitrification could considerably reduce groundwater nitrate concentrations.

4. Conclusions

The use of an over winter cover crop (mustard) in a spring barley cropping system can enhance groundwater denitrification thereby reducing groundwater nitrate concentrations and indirect N_2O emissions. The resulting denitrification produced predominantly N_2 .

References

- Addy K., Kellogg D.Q., Gold A.J., Groffman P.M., Ferendo G. and Sawyer C. 2002. In situ push-pull method to determine groundwater denitrification in riparian zones, *Journal of Environmental Quality* 31, 1017-1024.
- Fenton O., Coxon C., Haria A., Horan B., Humphreys J., Johnston P., Necpalova M., Premrov A. and Richards K.G. 2009. Variations in travel time and remediation potential for N loading to groundwaters in four case studies in Ireland: Implications for policy makers and regulators, *Tearmann* 7, 129-142.
- Mosier A.R. and Klemetsson L. 1994. Measuring denitrification in the field, pp. 1047-1065. In: R.W. Weaver et al. (eds.), *Methods of soil analysis. Part 2. Microbiological and biochemical properties*. 2nd edn. SSSA, Madison, WI.
- Premrov A., Coxon C.E., Hackett and Richards K.G. 2011. Management strategies to reduce nitrate leaching from spring barley to groundwater on a vulnerable soil, In: *Proc. of 31st Annual Groundw. Conference, Tullamore. IAH Irish group*.
- Premrov A., Coxon C.E., Hackett R., Brennan D., Sills P. and Richards, K.G. 2009. Over-winter green cover in a spring barley system: Role in exporting dissolved organic carbon to shallow groundwater and implications for denitrification, In: Bosch A., Teira M.R., & Villar J.M. (eds.), *Proc. of 16th Nitrogen Workshop*. p. 357-361.

The effect of crop establishment system on the nitrogen use efficiency of cereal grain crops in Ireland

Brennan, J.^{ab}, McCabe, T.^b, Hackett, R.^a, Forristal, P.D.^a

^aTeagasc, CELUP, Crops Research Oakpark, Co Carlow, Rep. of Ireland

^bSchool of Agriculture, Food Science and Veterinary Medicine, NUI Dublin, Ireland

1. Background & Objectives

The dominant establishment system for cereal grain crops in Ireland is based on ploughing (P) followed by a secondary cultivation combined with sowing. While there has been an increased adoption of shallow, non-inversion, minimum tillage (MT) establishment systems in the past 12 years it accounts for less than 4% of the total cereal area (CAIR, 2007). Most MT established crops are winter sown on a small number of large farms. However, as the cereal grain industry becomes more specialised and the cost of production continues to rise, growers are looking for a reliable, cost-effective and sustainable method of crop establishment.

The beneficial effects of minimum tillage on a number of soil properties have been well documented (Morris et al., 2010; Rasmussen, 1999; Simon et al., 2009). However, the effect of establishment system on the Nitrogen status of a crop is not as conclusive, and appears to vary considerably with climate. A number of studies have been conducted on the nitrogen uptake of crops established with different systems (Malhi et al., 2006; Meyer-Aurich et al., 2009) with variable results but few, if any of these studies are applicable in Ireland. The objective of these trials described here was to determine if establishment system affects the N uptake patterns of winter wheat and spring barley.

2. Materials & Methods

Field experiments were carried out on winter wheat (WW) and spring barley (SB) in 2009 and 2010 on a medium textured clay loam in the south east of Ireland. A 4 x 5 factorial experimental design was used for the winter wheat trials with four establishment systems (MT; MT+S; P; P+S) where +S indicates straw incorporation and 5 N rates (0, 140, 180, 220, 260 kg/ha) with 4 replications. For the Spring Barley trials a 4 x 5 factorial design using four establishment systems (MT-Autumn; MT-Autumn+Spring; MT-Spring; Plough-Spring) and 5 N rates (0, 75, 105, 135, 165 kg ha⁻¹) with 5 replications was used. For both wheat and barley, crop N uptake (CNU) were recorded during the growing season. Grain and straw N uptake, grain yield and grain protein were recorded at harvest. Statistical analysis was carried out by analysis of variance using Genstat.

3. Results & Discussion

The performance of the winter wheat varied considerably between the two seasons. In 2009 the MT treatment had an increasing CNU as the season progressed with a significantly higher uptake than the P treatment at GS 65 and 75. However, cultivation system had no significant effect on grain yield or total N uptake at harvest. Due to poor crop establishment with MT in 2010, the P treatments had a higher CNU at GS 24, 28, 32 and 47. Although there was no difference in CNU at GS 65 or 70 the P treatments had a significantly higher grain yield and total N uptake than the MT at harvest. Straw incorporation had little effect in both seasons.

The Spring Barley also varied with season but not as extremely as the winter wheat. In 2009, the MT-Spring establishment method performed poorly compared to the other establishment methods with a significantly lower CNU at GS 55 and 85, and reduced total N uptake and grain yield at harvest. The plough-based system achieved the highest total N uptake and grain yield. All four establishment systems performed similar in 2010 with no significant difference in total N uptake or grain yield. In both years grain yields were moderate to low considering the normal yield potential at this location.

Table 1. Results from fertiliser nitrogen programmes on winter wheat with different establishment systems

	2009				2010			
	+ Straw		- Straw		+ Straw		- Straw	
	P	MT	P	MT	P	MT	P	MT
Grain N _{upt} (kg/ha)	106.2 ^a	110.1 ^a	110.4 ^a	114.6 ^a	92.6 ^b	75.3 ^a	95.8 ^b	66.4 ^a
Straw N _{upt} (kg/ha)	31.30 ^a	36.33 ^a	37.32 ^a	36.09 ^a	26.47 ^a	25.54 ^a	25.96 ^a	22.82 ^a
N.U.E. %	39.79 ^a	42.50 ^a	40.93 ^a	45.74 ^a	47.87 ^c	39.86 ^b	50.86 ^c	28.98 ^a
Grain Yield (t/ha)	6.988 ^a	6.991 ^a	7.172 ^a	7.311 ^a	5.888 ^b	4.525 ^a	6.174 ^b	3.985 ^a

*Means with a common superscript are not significantly (P<0.05) different.

Table 2. Results from fertiliser nitrogen programmes on spring barley with different establishment systems

	2009				2010			
	P	MT	MT	MT	P	MT	MT	MT
	Spring	Autumn	A + S	Spring	Spring	Autumn	A + S	Spring
Grain N _{upt} (kg/ha)	82.40 ^c	83.03 ^c	75.59 ^b	69.45 ^a	79.01 ^b	79.87 ^a	81.69 ^a	82.29 ^a
Straw N _{upt} (kg/ha)	22.43 ^b	23.57 ^b	22.38 ^b	18.82 ^a	19.35 ^a	22.18 ^c	21.60 ^{bc}	19.94 ^{ab}
N.U.E. %	66.0 ^a	61.1 ^a	52.3 ^a	54.3 ^a	58.7 ^a	58.8 ^a	55.9 ^a	60.6 ^a
Grain Yield (t/ha)	5.139 ^c	5.040 ^{bc}	4.682 ^b	4.311 ^a	4.988 ^{ab}	4.581 ^a	4.814 ^{ab}	5.022 ^b

*Means with a common superscript are not significantly (P<0.05) different.

4. Conclusion

The N uptake pattern of both crops was influenced by establishment system. The effects however, were not consistent between years. These field experiments indicate that the performance of MT systems for winter wheat and spring barley establishment is season dependent and the plough-based system proved the most reliable establishment method.

References

- CAIR 2007. Conservation Agriculture Ireland report. www.geraghtyconsulting.com
- Morris N.L., Miller P.C.H., Orson J.H. and Froud-Williams R.J. 2010. The adoption of non-inversion tillage systems in the United Kingdom and the agronomic impact on soil, crops and the environment—A review
- Simon T., Javurek M., Mikanova O. and Vach M. 2009. The influence of tillage systems on soil organic matter and soil hydrophobicity.
- Rasmussen K.J. 1999. Impact of ploughless soil tillage on yield and soil quality: A Scandinavian review.
- Malhi S.S., Lemke R., Wang Z.H. and Chhabra Beldev S. 2006. Tillage, nitrogen and crop residue effects on crop yield, nutrient uptake, soil quality, and greenhouse gas emissions.
- Meyer-Aurich A., Gandorfer M., Gerl G. and Kainz M. 2009. Tillage and fertilizer effects on yield, profitability and risk in a corn-wheat-potato-wheat rotation

The effect of dicyandiamide addition to cattle slurry on rates of nitrification at a grassland site in Northern Ireland.

McGeough, K.L.^a, Müller, C.^b, Laughlin, R.L.^a, Watson, C.J.^a, Ernfors, M.^c, Cahalan, E.^{b,c}, Richards, K.G.^c

^a Agri-Food and Biosciences Institute, Newforge Lane, Belfast, BT9 5PX, Northern Ireland

^b School of Biology and Environmental Science, University College Dublin, Belfield, Dublin 4, Ireland

^c Teagasc, Johnstown Castle Environmental Research Centre, Co. Wexford, Ireland

1. Background & Objectives

In order to comply with current European Union environmental legislation (Water Framework and Nitrates Directives) there is increased pressure to improve manure nitrogen efficiency. A potential strategy to reduce nitrogen losses through nitrate leaching and N₂O emissions is the use of nitrification inhibitors. Dicyandiamide (DCD) is a nitrification inhibitor which slows down the conversion of NH₄⁺ to NO₃⁻ and hence reduces NO₃⁻ leaching and the production of N₂O. The objective of this study was to determine the effect of DCD on gross nitrogen transformations in a grassland field study following slurry application.

2. Materials & Methods

A field study was conducted at the Agri-Food and Biosciences Institute, Hillsborough, Northern Ireland, to determine the effect of the nitrification inhibitor dicyandiamide (DCD) on gross N transformations after cattle slurry (CS) applications on three separate occasions (summer and autumn 2010 and spring 2011) using a ¹⁵N tracing model. Cattle slurry (33 tonnes ha⁻¹) amended with KNO₃ (65 kg N ha⁻¹), with or without DCD (at 15% NH₄⁺-N content of the CS) was surface applied to grassland with either the NH₄⁺ or the NO₃⁻ pool labelled with ¹⁵N (¹⁴CS¹⁵NO₃ or ¹⁵CS¹⁴NO₃). The four treatments were arranged in a randomised block design with 4 replicates of each treatment. Soil (0-7.5cm cores) from the treatments was extracted with 2M KCl (2:1 v/w proportion of KCl to soil) on 12 occasions over a period of 4 weeks post application. On each occasion the concentration and ¹⁵N enrichment of the NH₄⁺ and NO₃⁻ pools was determined. The ¹⁵N enrichment of the NO₃⁻-N and NH₄⁺-N were determined by methods based on the generation of N₂O for analysis by Isotope-Ratio Mass Spectrometry (Stevens and Laughlin, 1994; Laughlin et al., 1997). Gross soil N transformations were quantified with a ¹⁵N tracing model described by Müller et al. (2007) which considers six nitrogen pools and 12 nitrogen transformations (Figure 1).

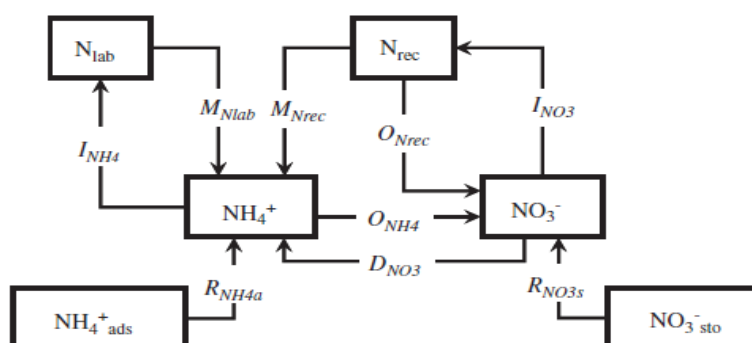

Figure 1. ¹⁵N tracing model (Müller et al., 2007) (N_{lab} = labile soil organic N, N_{rec} = recalcitrant soil organic N, $NH_4^+_{ads}$ = adsorbed NH_4^+ , $NO_3^-_{sto}$ = stored NO_3^- , M_{Nlab} = mineralisation of N_{lab} , M_{Nrec} = mineralisation of N_{rec} , I_{NH_4} = immobilisation of NH_4^+ , I_{NO_3} = immobilisation of NO_3^- , O_{Nrec} = oxidation of N_{rec} to NO_3^- , O_{NH_4} = oxidation of NH_4^+ to NO_3^- , D_{NO_3} = dissimilatory reduction of NO_3^- to NH_4^+ , R_{NH_4a} = release of adsorbed NH_4^+ , and R_{NO_3s} = release of stored NO_3^-).

3. Results & Discussion

Gross nitrification rates are shown in Figure 2. In the presence of DCD, the rate of O_{NH_4} (autotrophic and heterotrophic oxidation of NH_4^+ to NO_3^-) showed a significant decrease ($P < 0.001$) of 99.9%, 81.9% and 90.1% in June 2010, October 2010 and March 2011 respectively. In comparison to rates of O_{NH_4} , the rates of O_{Nrec} (heterotrophic oxidation of organic-N to NO_3^-) were low. O_{Nrec} increased significantly ($P < 0.001$) from $0.064 \mu\text{g N g}^{-1} \text{d}^{-1}$ to $0.275 \mu\text{g N g}^{-1} \text{d}^{-1}$ when DCD was added in June 2010, and a significant increase ($P < 0.05$) from $0.066 \mu\text{g N g}^{-1} \text{d}^{-1}$ to $0.163 \mu\text{g N g}^{-1} \text{d}^{-1}$ was measured in October 2010. However, there was no significant change in O_{Nrec} when DCD was added in March 2011.

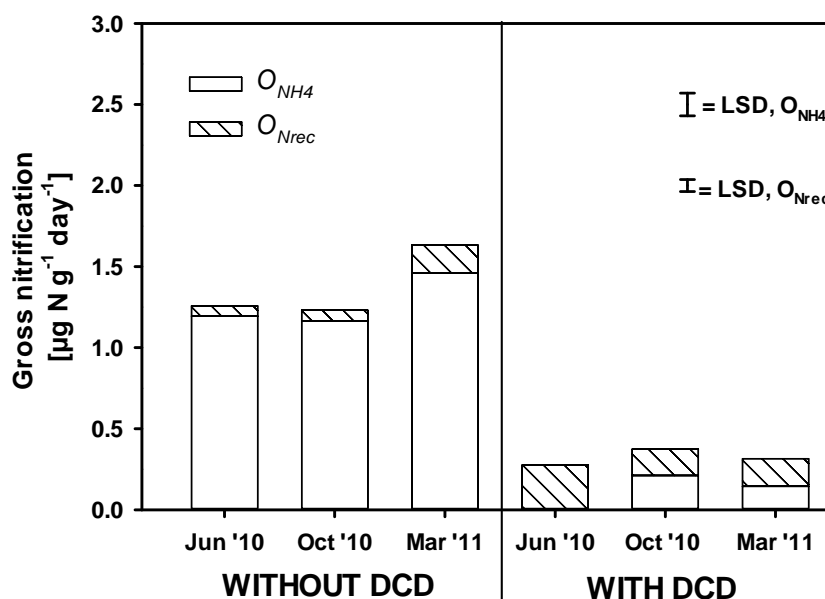

Figure 2. Gross NH_4^+ nitrification rates (O_{NH_4}) and organic-N nitrification rates (O_{Nrec}) for $CSNO_3$ with and without DCD applied to grassland soil in June 2010, October 2010 and March 2011. LSD, least significant difference when comparing any two means for $P=0.05$.

4. Conclusion

This study has demonstrated that NH_4^+ oxidation in cattle slurry was strongly inhibited by DCD on all three application dates. In contrast rates of heterotrophic nitrification of organic-N were low and DCD did not have an inhibiting effect. Overall, the percentage decrease in total nitrate production ($O_{NH_4} + O_{Nrec}$) was calculated as 78%, 70% and 81% for June 2010, October 2010 and March 2011, respectively demonstrating that DCD was highly effective in slowing the rate of nitrate production under field conditions when CS was applied to a grassland soil.

References

- Laughlin, R.J., Stevens, R.J. and Zhuo, S. 1997. Determining nitrogen-15 in ammonium by producing nitrous oxide. *Soil Science Society of America Journal* 61, 462-465.
- Müller, C., Rütting, T., Kattge, J., Laughlin, R.J. and Stevens, R.J. 2007. Estimation of parameters in complex ^{15}N tracing models by Monte Carlo sampling. *Soil Biology and Biochemistry* 39, 715-726.
- Stevens, R.J. and Laughlin, R.J. 1994. Determining nitrogen-15 nitrite or nitrate by producing nitrous oxide. *Soil Science Society of America Journal* 58, 1108-1116.

The effect of mineral N fertiliser dose on nitrogen efficiency of silage maize

Černý, J., Balík, J., Kulhánek, M., Vašák, F., Peklová, L., Sedlář, O., Shejbalová, Š.

Department of Agro-Environmental Chemistry and Plant Nutrition, Czech University of Life Sciences in Prague, Prague, Czech Republic

1. Background & Objectives

Silage maize (*Zea mays L.*) is a crop, which is very responsive to N fertilisation and large amounts of N are generally applied to maize cultivations. The positive effects of nitrogen supply from mineral fertilizer or organic fertilizers on the yield of dry matter (DM) from maize are well documented (Schröder et al., 1998). Although maize has a high N use efficiency field balances still show considerable N surpluses due to excessive input of organic and mineral fertilisers, which are applied alone or in combination. Most of agricultural companies in the Czech Republic limit fertilization to usage of mineral nitrogen fertilizers and the amount of nutrients uptake by main and secondary products are often higher than the input of nutrients to soil in fertilizers. Adjusting N application rates to crop needs can improve N use efficiency and reduce N losses. The objective of this study is to evaluate effects of different application rates of mineral nitrogen fertilizers (MNF) on yield of silage maize and N uptake efficiency in long-term field experiment.

2. Materials & Methods

The experiment, established in 1992, was carried out on the experimental field of the Czech University of Life Sciences Prague in Czech Republic (50°7'40"N, 14°22'33"E). The climate is dry temperate, drought periods may occur, mainly in late spring and summer. The soil is Chernozem with loamy texture (Černý et al., 2010). Silage maize has been continuously cultivated since the beginning of the experiment. The treatments were compared in a split-plot design. The size of experimental plots was 46 m². The trial comprised 5 treatments: no fertilization (control), four mineral N rates (calcium ammonium nitrate) (60, 120, 180, 240 kg N ha⁻¹) prior to crop sowing. No other nutrients and liming were used since the beginning of the experiment. The N content of the aboveground biomass was estimated using a Kjeldahl procedure. Efficiency of N fertilizer N was calculated according to the difference method (Dobermann, 2007; Nannen et al., 2011) considering the DM yield and N uptake by the maize: i) nitrogen utilization efficiency (NUE, kg kg⁻¹) as the ratio between yield and total N uptake; ii) agronomic efficiency of applied N (AE_N, kg kg⁻¹) as the ratio of (yield at N_x – yield at N₀) and applied N at N_x, iii) recovery efficiency of applied N (RE_N, %) as the ratio of (uptake at N_x – uptake at N₀) and applied N at N_x, iv) physiological efficiency of applied N (PE_N, kg kg⁻¹) as the ratio of (yield at N_x – yield at N₀) and (uptake at N_x – uptake at N₀).

3. Results & Discussion

All results for this research are presented as average from 1997 to 2008 experimental years. The average dry matter (DM) yields were 11.2–14.8 t ha⁻¹. The lowest yield was determined in the control variant, the highest yield in the variant 240 kg N ha⁻¹. In some years, however, 240 kg N ha⁻¹ did not increase the yield compared to the amount of 180 kg N ha⁻¹. Average nitrogen uptakes were 88–185 kg N ha⁻¹, when the average N contents in DM were 0.8–1.25 %. From this result it is evident that the amount of 240 kg of N per hectare did not increase the content of nitrogen in the dry matter of the silage maize more distinctly when compared with the variant 180 kg N ha⁻¹. Similar to Nannen et al. (2011), in variants 180 kg N ha⁻¹ and 240 kg N ha⁻¹ the uptake of nitrogen was estimated lower compared with the amount of N, which was at the beginning of the growing season applied in fertilizer (Figure 1).

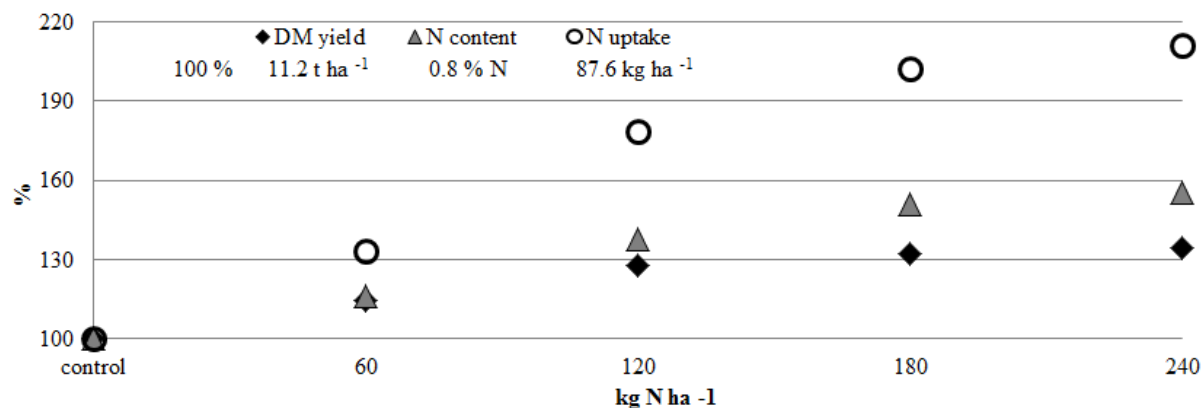

Figure 1. The relative effect of the N amount on the DM yield, nitrogen content and nitrogen uptake by the silage maize related to the control (100 %)

NUE was relatively stable value during the evaluated period and range between 80.53 and 124.86 kg N ha⁻¹. The highest value of AE_N was calculated for the amount of 60 kg N ha⁻¹ and 120 kg N ha⁻¹. The lowest AE_N was calculated for the application of 240 kg of N ha⁻¹. The highest values of RE_N were calculated in the variant 120 kg N ha⁻¹ and they were decreasing with higher amount of N applied, which corresponds with the lower use of the applied N. The average values of RE_N in all variants were calculated from 40.51 to 57.49 %. The highest value of PE_N (55.27 kg kg⁻¹) was found out for the amount of 60 kg N ha⁻¹ and the PE_N value decreased with an increasing amount of N (Table 1).

Table 1. The effect of the N amount and on the silage maize N efficiency indices

Treatment	NUE	AE _N	RE _N	PE _N
kg N ha ⁻¹	kg kg ⁻¹	kg kg ⁻¹	%	kg kg ⁻¹
0	124.86	-	-	-
60	107.77	27.54	48.95	55.27
120	90.76	26.74	57.49	44.56
180	82.91	20.59	49.86	38.87
240	80.53	16.44	40.51	38.29

4. Conclusion

Higher DM yield, N content and N uptake by silage maize were with the increasing N dose, but the best use of nitrogen from MNF had been reached by a nitrogen rate of 60 and 120 kg ha⁻¹.

References

- Černý, J., Balík, J., Kulháněk, M., Čásová, K. and Nedvěd, V. 2010. Mineral and organic fertilization efficiency in long-term stationary experiments. *Plant Soil and Environment* 56, 28-36.
- Dobermann, A.R. 2007. Nutrient use efficiency – measurement and management. IFA International Workshop on Fertilizer Best Management Practices, 7-9 March, 2007, Brussels, Belgium.
- Nannen, D.U., Herrmann, A., Loges, R., Dittert, K. and Taube, F. 2011. Recovery of mineral fertiliser N and slurry N in continuous silage maize using the ¹⁵N and difference methods. *Nutrient Cycling in Agroecosystems* 89, 269-280.
- Schröder, J.J., Neeteson, J.J., Withagen, J.C.M. and Noij, I.G.A.M. 1998. Effects of N application on agronomic and environmental parameters in silage maize production on sandy soils. *Field Crops Research* 58, 55-67.

Acknowledgement

This research was supported by the Ministry of Agriculture of the Czech Republic, project No. QH 91081

The impact of crop rotation and N fertilization on the growth and yield of winter wheat

Vári E., Pepó P.

Institute of Crop Science, Faculty of Agricultural and Food Sciences and Environmental Management, Centre for Agricultural and Applied Economic Sciences, University of Debrecen, Hungary

1. Background & Objectives

According to Lönhardné and Kismányoky (1992) and Lönhard and Németh (1988), N fertilization significantly increased leaf area index (LAI) and leaf area duration (LAD) in winter wheat and the leaf area index determined the yield. Petr et al. (1985) found that the yield of cereals was increased leaf area index up to a certain limit. According to Pepó (2002), fertilization is one of the major technological elements of wheat production, because it has a direct or indirect impact on all other technological elements. Pepó (2009) found that the optimum fertilizer doses vary between $N_{150-200}+PK$ in biculture and $N_{50-150}+PK$ in triculture depending upon the year and the water supply. Montemurro et al. (2007) did not detect differences in yields of winter wheat between the fertilizer treatments $N_{120}+PK$ and $N_{180}+PK$.

2. Materials & Methods

The experiments were carried out at the Látókép experimental station of the University of Debrecen on chernozem soil in a long term winter wheat experiment in the season of 2010/2011 in triculture (pea-wheat-maize) and biculture (wheat-maize) at three fertilization levels (control, $N_{50}+P_{35}K_{40}$, $N_{150}+P_{105}K_{120}$). The wheat variety used in the long-term trial was GK Csillag. The leaf area index was determined using the instrument SunScan Canopy Analysis Systems (SS1). Leaf area duration (LAD_{LAI}) was also calculated, which is the area under the LAI curve over time. LAD_{LAI} quantitatively expresses the length of time over which the stand maintains the photosynthetically active leaf area (Berzsenyi, 2000).

3. Results & Discussion

The leaf area per 1 m^2 ground surface was calculated and its dynamics was plotted (Figure 1). After maize forecrop, N fertilization had a significant effect on leaf area index dynamics and its maximum up to the treatment $N_{150}+PK$. In triculture, a similar trend was observed, significant differences were found between the three fertilization treatments. In both crop rotations, the maximum leaf area index was measured at flowering-grain filling in winter wheat stands. Considerably higher leaf area index was measured in triculture than in biculture (2.2 in the control; $4.1\text{ m}^2\text{ m}^{-2}$ in the treatment $N_{150}+PK$).

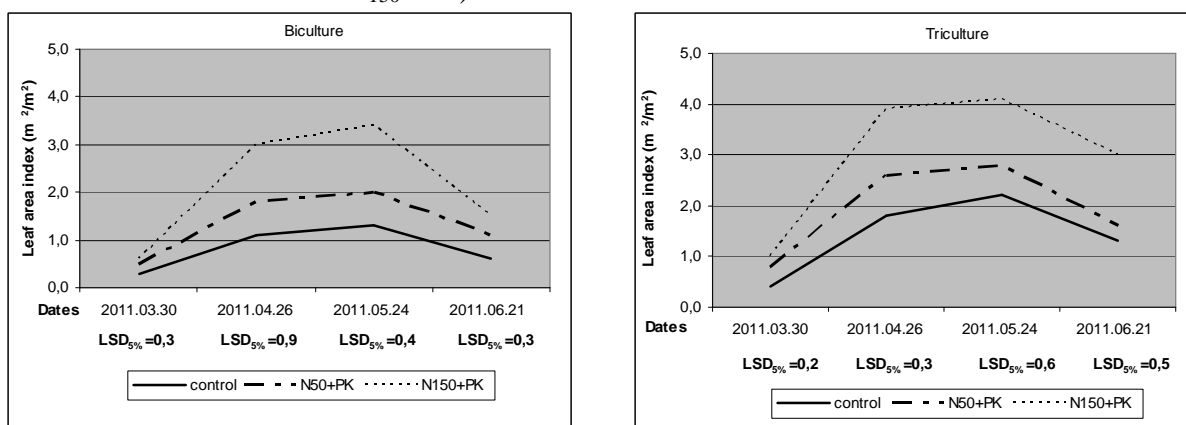

Figure 1. Dynamics of LAI-values of winter wheat in a bi- and triculture crop-rotation system (Debrecen, 2011.)

In triculture, yields were $2088-4615\text{ kg}\cdot\text{ha}^{-1}$ higher than in biculture at the same fertilization levels. After maize, the differences between the control and the fertilization level of $N_{150}+PK$ were

considerably higher than after pea as a forecrop. When studying the effect of fertilization, it can be stated that the yields significantly increased with increasing fertilization levels (Figure 2) and the maximum yield of winter wheat was obtained in the treatment N₁₅₀+PK in both crop rotations (7442 and 9830 kg·ha⁻¹).

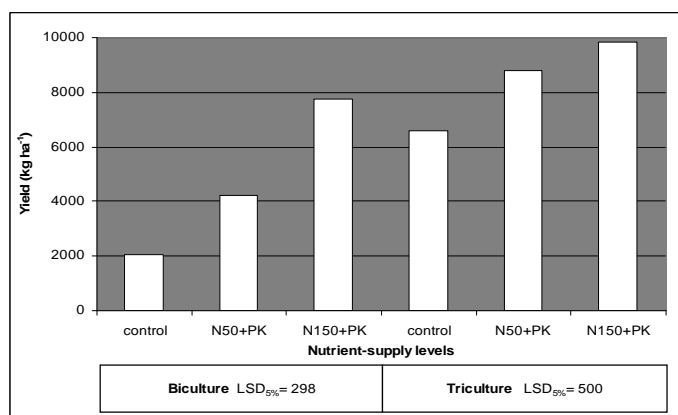

Figure 2. Effect of fertilisation on the yield of winter wheat in the a bi- and triculture crop rotation (Debrecen, 2011.)

According to the leaf area duration values (Table 1) the increasing N fertilization significantly increased the lifespan of leaves. When comparing the two crop rotations, the beneficial effect of the pea forecrop can be observed also in leaf area duration values.

Table 1. Effect of fertilisation on LAD of winter wheat in a bi- and triculture (Debrecen, 2011.)

Fertiliser doses	Biculture LAD _{LAI} (m ² m ² *day)	Triculture LAD _{LAI} (m ² m ² *day)
control	79	135
N ₅₀ +PK	128	183
N ₁₅₀ +PK	207	278
LSD _{5%}	17	27

4. Conclusion

N fertilization has an outstanding role in the changes in leaf area index (LAI), leaf area duration (LAD) and yield of winter wheat. According to our results, the interaction effect of leaf area index, leaf area duration and fertilization resulted in the maximum yield in biculture and triculture.

References

- Berzsenyi Z. 2000. Növekedésanalízis a növénytermesztésben. Egyetemi jegyzet Ph.D. hallgatóknak. Veszprémi Egyetem Georgikon Mezőgazdaságtudományi Kar. Keszthely.
- Lönhard Mné and Németh I. 1988. N-trágyázás hatása a búza (*Triticum aestivum* L.) levélfelületének alakulására. *Növénytermelés*. 37.4, 337-344.
- Lönhardné B.É. and Kismányoky T. 1992. Az istállótrágya és egyéb trágyák hatása a búza termésére, LAI, LAD, NAR értékeinek alakulására, vetésforgóban. *Növénytermelés* 41.5, 433-441.
- Montemurro F., Convertini G. and Ferri D. 2007. Nitrogen application in winter wheat grown in Mediterranean conditions: effects on nitrogen uptake, utilization efficiency, and soil nitrogen deficit. *Journal of Plant Nutrition*. 2007. 30: 10/12, 1681-1703. 33 ref.
- Pepó P. 2002. Az őszi búza fajtaspecifikus tápanyagellátása csernozjom talajon. II. Növénytermesztési Tudományos Nap. 105-110.
- Pepó P. 2009. Study of cropyear effects in cereal crop models. *Analele Universitatii din Oradea, Fascicula: Protectia Mediului*. 2009. 14: 216-221.
- Petr J. Cerny V. and Hruska L. 1985. A főbb szántóföldi növények termésképződése. Mezőgazdasági Kiadó. Budapest.
- Acknowledgment:** The work/publication is supported by the TÁMOP-4.2.2/B-10/1-2010-0024 project. The project is co-financed by the European Union and the European Social Fund.

The interactions among the nitrogen supply and the physiological parameters and yield of winter wheat genotypes

Szabó É., Pepó P.

Institute of Crop Sciences, Faculty of Agricultural and Food Sciences and Environmental Management, Centre for Agricultural and Applied Economic Sciences, University of Debrecen, Hungary

1. Background & Objectives

According to Houles et al. (2007), more precise results can be obtained about the nitrogen uptake of winter wheat if SPAD and leaf area index (LAI) values are examined together. Vidal et al. (1999) found a close correlation between SPAD values, nitrogen uptake and yield. Sugár and Berzsenyi (2010) found that in dry years, LAI was mainly influenced by nitrogen supply. Fois et al. (2009) claimed that nitrogen supply has a determining effect on yield in the case of winter wheat. As a result of higher nitrogen doses, larger leaf area is formed and the nitrogen content of foliage is also higher. Ziadi et al. (2010) found a tight positive correlation between nitrogen doses and SPAD values. Cartelat et al. (2005) found strong correlation between the SPAD values of winter wheat leaves and their chlorophyll content was $r=0.91$.

2. Materials & Methods

We have tested two winter wheat genotypes, GK Öthalom, which has been grown for a long time and a new, modern variety, Pannonikus. Four repetitions were set up in a small plot long-term experiment in a split plot design in the season of 2010/2011. The experimental soil was calcareous chernozem. In the treatments, three fertilization levels were studied, the control, $N=60 \text{ kg ha}^{-1}$, with $P_2O_5=45 \text{ kg ha}^{-1}$ and $K_2O=53 \text{ kg ha}^{-1}$ and its twofold dosage were applied. The chlorophyll content of the wheat leaves and the leaf area index (LAI) were measured with a portable Konica-Minolta SPAD 502Plus instrument and a portable SunScan Canopy Analysis Systems (SS1) instrument, respectively. Measurements were performed on five occasions during the season.

3. Results & Discussion

Table 1. represents the yields of the two wheat varieties at the different fertilization levels. Yields increased significantly with increasing fertilizer doses. The yields of Pannonikus were considerably higher than those of GK Öthalom both in the control (4719 kg ha^{-1}) and in the $N_{120}+PK$ treatment (8224 kg ha^{-1}).

Table 1. Effect of fertilization on the yield of winter wheat varieties. (Debrecen, 2011)

Treatment	GK Öthalom kg ha^{-1}	Pannonikus kg ha^{-1}
Control	3019	4719
$N_{60}+PK$	5745	7072
$N_{120}+PK$	6500	8224
LSD _{5%}	425	743

The differences in yields were due to the different fertilizer response of the varieties, the more modern Pannonikus was able to use the applied fertilizer dosage more efficiently. For both varieties, the lowest SPAD values were obtained in the control (Figure 1) and the values increased significantly with increasing fertilizer doses. The SPAD values of the variety Pannonikus were higher than those of GK Öthalom and the reduction in its SPAD values by the end of the season was less strong due to the increased fertilizer dosages.

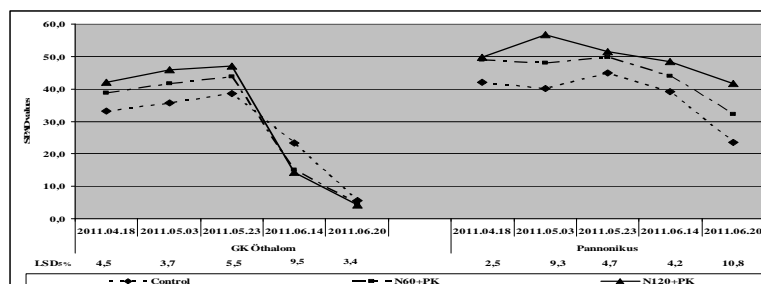

Figure 1. Interactions among the fertilization, the genotype and the SPAD values of winter wheat varieties. (Debrecen, 2011)

The effect of fertilizer doses was even more obvious in the case of the leaf area index (LAI) (Figure 2). The increasing nitrogen doses significantly increased the leaf area index in both varieties, the LAI was higher and the decrease was also more moderate for both fertilizer treatments for the variety Pannonikus due to its better fertilizer response.

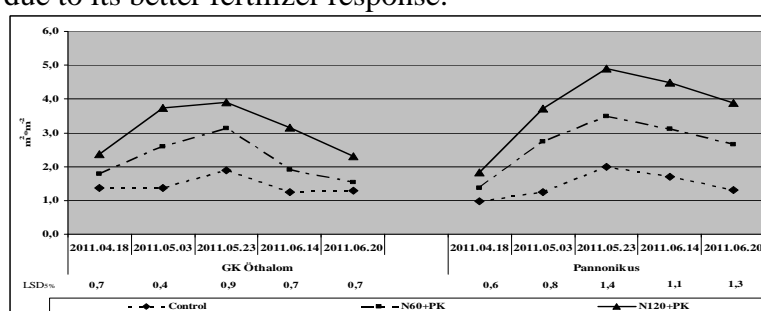

Figure 2. Interactions among the fertilization, the genotype and the leaf area index of winter wheat varieties. (Debrecen, 2011)

4. Conclusion

According to our results, it can be stated that the fertilizer treatments significantly increased the SPAD values and the leaf area index (LAI) of winter wheat genotypes with increasing nitrogen doses. The higher chlorophyll content and the larger assimilating surface contributed to the achievement of higher yields. The more modern variety, Pannonikus had better results both in its physiological parameters and yields due to its better fertilizer response.

References

- Cartelat A., Cerovic, Z.G.-Goulas, Y.-Meyer, S.-Lelarge, C.-Prioul, L.-Barbottin, A.-Jeuffroy, M.H.-Gate, P.-Agati, G.-Moya, I. (2005): Optically assessed contents of leaf polyphenolics and chlorophyll as indicators of nitrogen deficiency in wheat (*Triticum aestivum* L.). *Field Crops Research*.
- Fois S., Motzo R. and Giunta F. 2009. The effect of nitrogenous fertiliser application on leaf traits in durum wheat in relation to grain yield and development. *Field Crops Research*. 110. 69-75
- Houles V., Guerif M. and Marya B. 2007. Elaboration of a nitrogen nutrition indicator for winter wheat based on leaf area index and chlorophyll content for making nitrogen recommendations. *European Journal of Agronomy*. 27, 1-11
- Sugár E. And Berzsenyi Z. 2010. Growth dynamics and yield of winter wheat varieties grown at diverse nitrogen levels. *Acta Agronomica Hungarica* 58, 121-126
- Vidal, I., Longeri L. and Hétier J.M. 1999. Nitrogen uptake and chlorophyll meter measurements in Spring Wheat. *Nutrient Cycling in Agroecosystems* 55, 1-6
- Ziadi N., Bélanger G., Lefebvier L., Tremblay N., Cambouris A.N., Nolin M. C. and Parent L.É. 2010. Plant-based diagnostic tool for evaluating wheat nitrogen status. *Crop Science* 50, 2580-2589

The work/publication is supported by the TÁMOP-4.2.2/B-10/1-2010-0024 project. The project is co-financed by the European Union and the European Social Fund.

Using bromide as tracer to study the horizontal and vertical movement of nitrate under field conditions

Almadni, M. , Stockdale, E.A. , Cooper, J.M.

School of Agriculture, Food and Rural Development, Newcastle University, Newcastle upon Tyne, NE1 7RU, UK.

1. Background & Objectives

Porous ceramic cups are widely used for the extraction of soil solution for monitoring of nitrate leaching from arable land despite their acknowledged weaknesses. Bromide and chloride have both been widely used as a conservative tracer of nitrate movement, but this has dominantly focussed on following the vertical movement of nitrate through the soil profile (Lord and Shepherd, 1993; Webster et al., 1993). Under field conditions in some soils, lateral (horizontal) movement may also be an important component of the total nitrate movement (Waddell and Weil, 2006). Hence for any site it is important to understand the hydrological pathways leading to nitrate leaching and to assess the relative importance of both vertical and horizontal components of nitrate transport, especially where plot scale N balances are to be estimated. The aim of these field studies was to better understand the hydrological pathways of nitrate leaching in a large agronomic field experiment thus allowing better parameterisation of models used to estimate nitrate leaching.

2. Materials & Methods

Two experiments have been carried out using bromide as tracer during spring 2011 and overwinter 2011-2012. Porous ceramic (suction) cups were used to obtain soil solution samples during drainage and soil coring approaches were used to determine overall recovery. The field experiments were situated at Newcastle University's Nafferton Experimental Farm, Northumberland, UK under natural soil conditions. The soil is a surface water gley with a sandy loam topsoil. The 30 suction cups were installed at 30 and 60 cm (15 suction cups for each depth) in three replicate plots/areas under grass ley. Each group of suction cups (at either 30 or 60 cm) was arranged in a circle (1m radius) with one suction cup installed in the centre (source) and the 4 remaining cups equally spaced on the perimeter of the circle. For each circle the first cup on the perimeter was placed directly downslope of the centre (downslope). There was 3m between the two groups of suction cups. Initial soil samples were collected to determine soil water content and the background concentration of bromide. Bromide was extracted from soil (1:5 ratio) using de-ionised water. 300kg ha⁻¹ of bromide (as NaBr) was applied to the soil surface within a circular plot (0.5 m diameter) centred on the central porous cup. Soil solutions were collected from the porous cups weekly (80kPa suction for 2 hours) until the soil had dried so that solution samples could not be obtained. At the end of this period soil cores (0-90 cm) were collected close to the locations of the porous cups and also at an intermediate positions downslope of the application (3 samples 0.75 m from source) and one sample outside the perimeter (1.25 m beyond the downslope). These cores were divided (0-30, 30-60 and 60-90 cm); water content was determined and bromide extracted with de-ionised water. All bromide concentration in soil extracts and soil solution samples were determined by ion chromatography.

3. Results & Discussion

Soil solution data collected in the spring 2011 experiment showed that bromide moved downwards through the soil profile after application in March. At the end of this short experiment 36% of the applied bromide was recovered immediately below the source with 23% in 0-30 cm, 6.5% in 30-60 cm and 6.4% in 60-90 cm. At the source, soil solution samplers showed vertical movement of bromide during the experiment with the highest bromide concentration measured in the second

week after application at 30 cm depth (Figure 1). The peak bromide concentrations at 60 cm were lower and were not measured until the final sampling, there may have been some bromide concentration at this depth as the soil dried out. Downslope (0.5 m beyond any direct surface application of bromide), bromide was detected in the soil solution after 2 weeks at both 30 and 60 cm depths. While bromide concentrations at 30 cm were very significantly lower than those at the source; there was much less difference between bromide concentrations at 60 cm, suggesting that there may have been significant lateral movement of bromide within the soil profile. The primary result from this scoping study indicated that surface applied bromide could move both horizontally and vertically to 60 cm from March to May even in the presence of grass. Hence the second experiment overwinter 2011-12 was designed to investigate bromide movement during the main drainage period and consider the implications for the estimation of nitrate leaching in these soils. Data are still being processed and full bromide recovery together with residence times will be calculated.

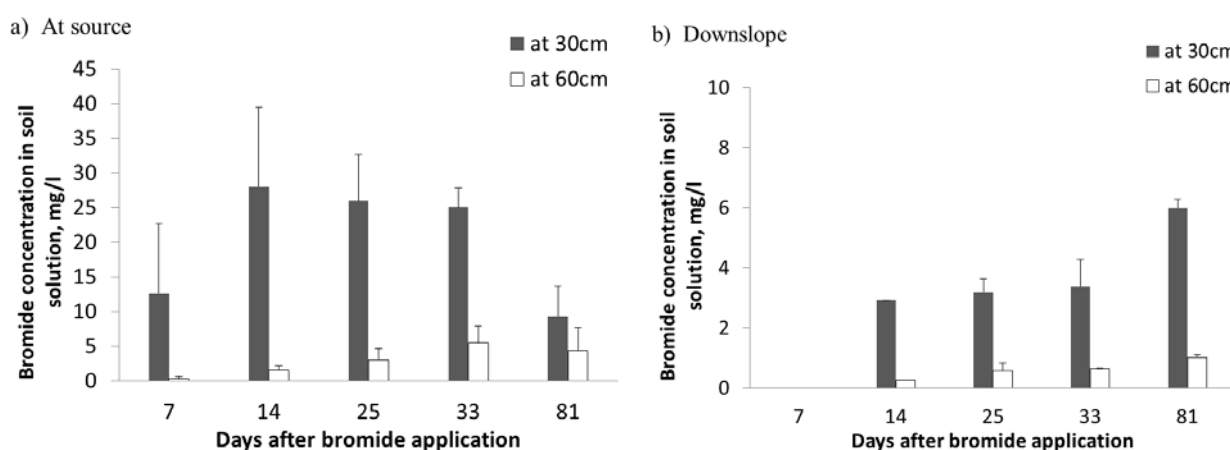

Figure 1. Mean concentration of bromide in soil solutions (mg l^{-1} ; with SD in brackets) obtained with porous ceramic cups installed at 30 and 60 cm depth on 5 occasions following application of bromide in March 2011

- a) immediately beneath a bromide application (source) and
 b) 0.5 m from the plot edge in a downslope direction (downslope).

4. Conclusion

For any site the relative importance of both vertical and horizontal components of nitrate movement should be determined. Most simple models of nitrate leaching do not take account of horizontal flow pathways; the preliminary data given here indicate that this is likely to be a major weakness where such models are used to estimate residence times and the environmental impacts of land management.

References

- Lord, E.I. and Shepherd, M.A. 1993. Developments in the use of porous ceramic cups for measuring nitrate leaching. *Journal of Soil Scienc*, 44, 435-449.
- Waddell, J.T. and Weil, R.R. 2006. Effects of fertilizer placement on solute leaching under ridge tillage and no tillage. *Soil and Tillage Research* 90, 194-204.
- Webster, C.P., Shepherd, M.A., Goulding, K.W.T. and Lord, E. 1993. Comparisons of methods for measuring the leaching of mineral nitrogen from arable land, *Journal of Soil Science* 44, 49-62.

Winter wheat nitrogen demand under different soil conditions

Anna-Karin Krijger

Rural Economy and Agricultural Society of Skaraborg, PO Box 124, 532 22 Skara, Sweden

1. Background & Objectives

The aim with this study was to explore the effects of soil nitrogen (N) supplying capacity under different growing conditions on optimum N fertilization level to improve the efficiency in use of added N to crops. Nitrogen fertilization experiments in barley and wheat over several years have shown large variations in optimum N fertilization between sites with similar yields (Gruvaeus, 2008). A major cause of variation was differences in N supply from the soil. Wetterlind (2010) showed that the optimal N dose varied greatly between years and location and even within the farm or the fields. Both the yield and soil N supply needs to be taken into account to estimate the optimum N fertilization level. Using zero-N subplots to estimate N supply on the site, and estimating biomass and N-content with an N-sensor in the BBCH 37 growth stage may improve optimization of N fertilization level.

2. Materials & Methods

The experimental layout was a fully randomized block design consisting of N fertilization levels from 0 to 280 kg N ha⁻¹ in 40 kg intervals to winter wheat. The first 40 kg N was added at the start of crop growth in early spring and the balance was applied at early stem elongation. All N was added as NS 27-4. Measurements of near infrared reflectance from the crop, using a hand held Yara N-Sensor, were carried out at BBCH 37-43 and in several cases two more times in addition to follow the crop N uptake and assess the crop N demand. Winter wheat varieties in the field experiments were Olivin, Opus, Ellvis, Hereford and Skalmeye. Preceding crop was spring cereals. The experimental plots were located on fields with different soil types and on farms with or without livestock. During 2007-2011 44 experiments with four replicates and with 36 m² plot-size were carried out. Optimum N rate was determined as an economical optimum based on a quotient of N prices 10 times grain price.

3. Results & Discussion

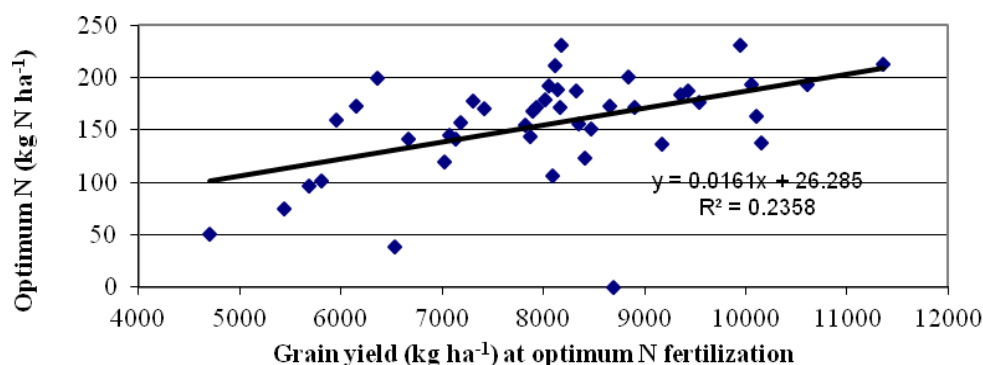

Figure 1. Regression between optimal nitrogen rate and harvest at optimal fertilization for 44 trials in 2007-2011. All varieties except Harnesk and Hereford.

Results from all 44 experiments showed a weak correlation between harvest grain yield and optimum N fertilization rate, (Figure 1). When optimum N fertilization rate and soil N supply was combined, determined from plots receiving no N, the regression between harvest grain yield and

optimum N fertilization rate were stronger. N demand was 15.6 kg N per tone of grain plus 111 kg N (Figure 2). Farms both with and without livestock were included but only sites with preceding crops of cereal were included. Figure 3 shows the correlation between the N-sensor value at the flag leaf stage (DC 37) in the unfertilized treatment and the grain N yield during 2009-2011, indicating that N-sensor measurements at the flag leaf stage shows the soil N contribution.

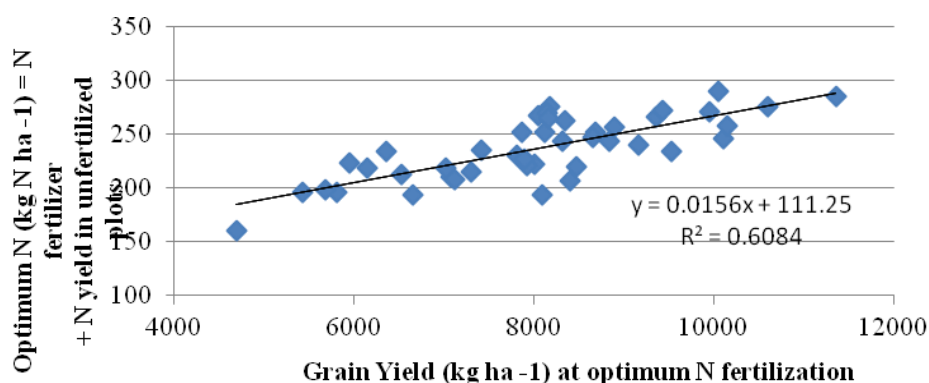

Figure 2. Winter wheat N demand (kg N ha⁻¹) at optimum N rate in relation to grain yield at the optimum N rate from 44 trials in central Sweden from year 2007 to 2011. All varieties except Harnesk and Hereford.

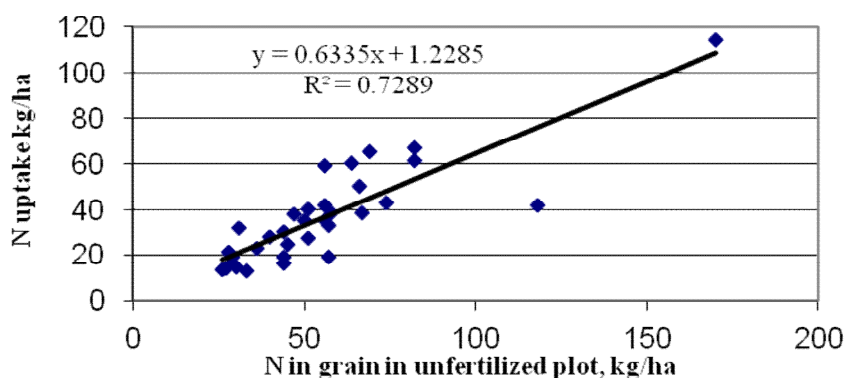

Figure 3. Correlation between N-sensor, N uptake at BBCH 37 and grain N at harvest. 34 trials in central Sweden during 2009 to 2011.

4. Conclusion

Optimum N fertilization varied greatly both between years and between sites. Measurements with the Yara N-sensor at the flag leaf stage indicated the soil N delivery to the crop. Zero-N plots are an important tool to find the optimum N fertilization level, because the grain yield between farms varies a lot. Having information on the actual soil N supply on the site for an individual year, using an N-sensor at flag leaf stage and taking the actual weather of the year into account, may help improve optimization of N fertilization for winter wheat.

References

- Gruvaeus, I. 2008. Nitrogen requirements of winter wheat under different soil conditions. Report 2007 for the regional field experiments. Rural Economy and Agricultural Society of Skaraborg. pp. 26-32.
- Wetterlind, J. 2010. Measurements with Yara N-sensor for estimating soil nitrogen supplying capacity. Swedish University of Agricultural Sciences, Department of Soil and Environment. Report 4, 20 pp.

2 SESSION

*A Holistic Approach to Understanding Impacts of
Nitrogen on the Environment*

Oral Presentations

An integrated approach to reactive nitrogen in the environment

Sutton, M. A.

Centre for Ecology and Hydrology, Edinburgh Research Station, Bush Estate, Penicuik, Midlothian, EH26 0QB, United Kingdom.

1. Background

Human alteration of the nitrogen cycle represents a major driver of global environmental change. Since the invention, a century ago, of industrial methods to fix atmospheric dinitrogen (N_2), the production of reactive nitrogen (N_r) has roughly doubled at the global scale and tripled in Europe (Erisman et al., 2008; Galloway et al., 2008; Sutton et al., 2011a). The main use of this deliberate anthropogenic N_r production has been to produce fertilizers to increase crop production, allowing the world's human population to increase, as well as for people to eat richer diets, with a larger fraction of animal products. In parallel, increased rates of fuel combustion have caused an additional inadvertent rise in anthropogenic N_r production and release to the atmosphere. This has especially been the result of greater use of high temperature combustion processes in vehicles, electricity generation and other industries, which oxidize atmospheric N_2 to nitrogen oxides (NO_x). In addition, low temperature combustion processes, from domestic burning of coal, wood, dung and burning of forests and other land, have led to an increase in both NO_x and ammonia (NH_3) emissions. Together with the emissions of N_r from agricultural systems in the form of NH_3 , NO_x , nitrous oxide (N_2O), nitrates (NO_3) and many organic nitrogen forms, this human alteration of the nitrogen cycle is causing multiple effects on global change. The consequences include pollution of air, soil and water, alteration of the climate balance and threats to biodiversity. While some policies have already been enacted in Europe and elsewhere, N_r pollution represents a still largely unsolved problem. Many details of the science remain uncertain, while levels of N_r pollution are causing major threats across Europe and other industrialized and agricultural areas of the world. The complexity is illustrated by the way in which N_r emissions alter climate balance.

2. Results & Discussion

The recent European Nitrogen Assessment (ENA) estimates that N_r emissions may be having a net cooling effect on climate, as aerosol N_r effects and forest fertilization from atmospheric N_r deposition tend to outweigh the warming effects of N_2O emissions and the N_r contribution to O_3 formation (Butterbach-Bahl et al., 2011). However, the cooling components of N_r have even bigger estimated societal costs than their climate benefits, as aerosols affect human health and N_r deposition threatens biodiversity. Overall, the ENA estimates a societal damage cost of between €70 billion to €320 billion per year across the European Union (Brink et al., 2011; Sutton et al., 2011c). Even from this limited set of interactions, it is clear that human alteration of the nitrogen cycle is a highly complex issue, with major economic consequences. Advances in the underlying science are needed using new measurement methods and models, as a basis to inform policies that maximize the intended benefits of N_r , while minimizing its environmental threats. The extent of these interactions can be seen clearly from the European Nitrogen Budget, with Figure 1 highlighting 7 areas for key actions to improve nitrogen management at a European scale. The figure clearly illustrates the dominant influence of livestock agriculture on the European nitrogen cycle, where 85% of harvested crop nitrogen feeds livestock with only 15% feeding humans directly

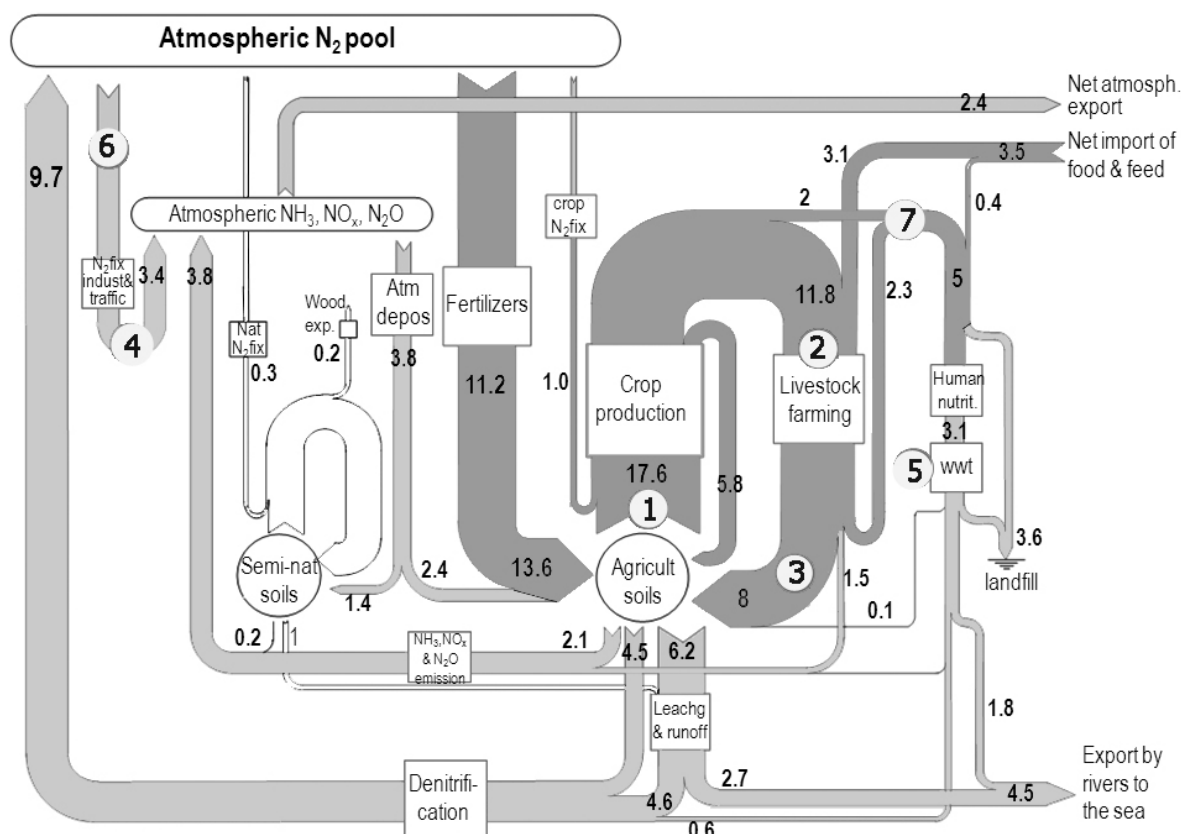

Figure 1. Summary of the European Nitrogen Budget, around the year 2000 (values in Tg N per year). White arrows are natural nitrogen fluxes; Dark grey arrows are intended agricultural nitrogen flows; Light grey arrows are unintended anthropogenic nitrogen flows. The numbered white circles show 7 areas for taking key actions to improve overall nitrogen management. The figure clearly illustrates the dominant influence of livestock agriculture on the European nitrogen cycle, where 85% of harvested crop nitrogen feeds livestock with only 15% feeding humans directly.

These issues have been addressed by concerted efforts in Europe over the last 5 years, as a number of projects have contributed to the global ambitions of the International Nitrogen Initiative (INI), a joint project under the International Geosphere Biosphere Programme (IGBP) and the Scientific Committee on Problems of the Environment (SCOPE). The European collaboration has linked closely to the efforts of the NitroEurope Integrated Project, a consortium of 62 institutes funded by the European Union 6th Framework Programme to examine the effect of nitrogen on the European greenhouse gas balance (Sutton et al., 2007, 2011b).

In order to increase the scientific scope, NitroEurope has worked closely with the Nitrogen in Europe (NinE) framework networking programme of the European Science Foundation (Bleeker et al., 2008), allowing an increased focus on interactions with biodiversity, water quality, policy and economic issues. In parallel, the COST Action 729, “Assessing nitrogen fluxes in the atmosphere biosphere system”, has added to the critical mass through workshops to stimulate collaborative activities, including a major focus on the interaction between nitrogen deposition and the Natura 2000 network, protected under the EU Habitats Directive

(Hicks et al., 2011; Bleeker and Erisman, 2011). Finally, efforts have been made to develop a number of tools that raise the question of the nitrogen challenge across scientific communities and with wider society (NinE, 2011 (Barsac Declaration); NinE 2009 (ENA Video); NGCC, 2011 (Edinburgh Declaration); Leach et al. 2012 (N-print)).

This paper will draw together a synthesis of these recent activities, highlighting how developments focusing on overall reduction of national-scale N_r surpluses and improvement in full-chain nitrogen use efficiency (NUE) provide the basis for a more streamlined management of the nitrogen cycle. If the current level of adverse effects are to be reduced, and future threats on the global scale avoided, this will require a major change in societal consciousness. Key elements will be to put a much higher priority on nitrogen mitigation actions in arable and livestock agriculture, while redressing the current increase in human consumption of animal products above thresholds for the protection of both the environment and human health.

References

- NinE. 2009. The Barsac Declaration: Environmental Sustainability and the Demitarian Diet <http://www.nine-esf.org/Barsac-text>
- Bleeker, A. and Erisman, J.W. 2011. Assessing and managing nitrogen fluxes in the atmosphere-biosphere system in Europe. Final report of COST Action 729. (Eds.) pp 186-190, ECN for COST, Strasbourg. [ISBN: 978-90-817039-1-8].
- Bleeker, A., Reis, S., Britton, C., Erisman, J.W. and Sutton, M.A. 2008. Actividades relacionadas con el ciclo del Nitrógeno en Europa. Seguridad Y Medio Ambiente 111 (3), 22-31. (in Spanish) English summary: Nitrogen in Europe: Activities addressing the European nitrogen cycle. Seguridad Y Medio Ambiente 111, 6-7.
- Brink, C., Grinsven, H. et al. 2011. Costs and benefits of nitrogen in the environment. Chapter 22, in: The European Nitrogen Assessment (Eds. Sutton M.A., Howard C., Erisman J.W., Billen G., Bleeker A., Grenfelt P., van Grinsven H. and Grizzetti B.) pp 513-540, Cambridge University Press.
- Butterbach-Bahl, K., Nemitz, E., Zaehle, S., Billen, B., Boeckx, P., Erisman, J.W., Garnier, J., Upstill-Goddard, R., Kreuzer, M., Oenema, M., Reis, S., Schaap, M., Simpson, D., de Vries, W., Winiwarter, W. and Sutton, M.A. 2011. Effect of reactive nitrogen on the European greenhouse balance. Chapter 19 in: The European Nitrogen Assessment (Eds. Sutton M.A., Howard C., Erisman J.W., Billen G., Bleeker A., Grenfelt P., van Grinsven H. and Grizzetti B.) pp 434-462. Cambridge University Press.
- Erisman, J.W., Sutton, M.A., Galloway, J.N., Klimont, Z. and Winiwarter, W. 2008. How a century of ammonia synthesis changed the world. Nature Geoscience 1, 636-639, DOI: 10.1038/ngeo325.
- Galloway, J.N., Townsend, A.R., Erisman, J.W., Bekunda, M., Cai, Z., Freney, J.R., Martinelli, L.A., Seitzinger, S.P. and Sutton, M.A. 2008. Transformation of the Nitrogen Cycle: Recent Trends, Questions and Potential Solutions. Science, 320, 889-892. DOI: 10.1126/science.1136674
- Hicks, W.K., Whitfield, C.P., Bealey, W.J. and Sutton, M.A. 2011. 'Nitrogen Deposition and Natura 2000: Science & practice in determining environmental impacts' (Eds.) (Findings of a European workshop linking scientists, environmental managers and policymakers, Brussels, 18th - 20th May, 2009), COST Office, Brussels.
- Leach, A.M., Galloway, J.N., Bleeker, A., Erisman, J.W., Kohn, R. and Kitzes, J. 2012. Nitrogen footprint model to help consumers understand their role in nitrogen losses to the environment. Environmental Development. (In press.)
- NinE. 2011. Official launch video of the European Nitrogen Assessment, YouTube: <http://www.youtube.com/watch?v=uuwN6qxM7BU>
- NGCC. 2011. The Edinburgh Declaration on Reactive Nitrogen, Nitrogen and Global Change Conference http://www.nitrogen2011.org/edinburgh_declaration
- Sutton M.A., Howard C., Erisman J.W., Billen G., Bleeker A., Grenfelt P., van Grinsven H. and Grizzetti B. 2011a. The European Nitrogen Assessment (Eds.) Cambridge University Press. 612 pp.
- Sutton M.A., E. Nemitz, J.W. Erisman, C. Beier, K. Butterbach Bahl, P. Cellier, W. de Vries, F. Cotrufo, U. Skiba, C. Di Marco, S. Jones, P. Laville, J.F. Soussana, B. Loubet, M. Twigg, D. Famulari, J. Whitehead, M.W. Gallagher, A. Neftel, C.R. Flechard, B. Herrmann, P.L. Calanca, J.K. Schjoerring, U. Daemmgen, L. Horvath, Y.S. Tang, B.A. Emmett, A. Tietema, J. Peñuelas, M. Kesik, N. Brueggemann, K. Pilegaard, T. Vesala, C.L. Campbell, J.E. Olesen, U. Dragosits, M.R. Theobald, P. Levy, D.C. Mobbs, R. Milne, N. Viovy, N. Vuichard, J.U. Smith, P. Smith, P. Bergamaschi, D. Fowler, and Reis S. 2007. Challenges in quantifying biosphere-atmosphere exchange of nitrogen species. Environmental Pollution 150, 125-139.

Sutton M.A., Nemitz E., Skiba U.M., Beier C. Butterbach Bahl K., Cellier P., de Vries W., Erisman J.W., Reis S., Bleeker A., Bergamaschi P., Calanca P.L., Dalgaard T., Duyzer J., Gundersen P., Hensen A., Kros J., Leip A., Olesen J.E., Owen S., Rees R.M., Sheppard L.J., Smith P., Zechmeister-Boltenstern S., Soussana J.F., Theobald M.R., Twigg M., van Oijen M., Veldkamp T., Vesala T., Winiwarter W., Carter M.S., Dragosits U., Flechard C., Helfter C., Kitzler B., Rahn K.H., Reinds G.J., Schleppi P., with contributions from the NitroEurope community. (2011b) The nitrogen cycle and its influence on the European greenhouse gas balance. Centre for Ecology and Hydrology, 43 pp. http://www.nitroeuropa.eu/webfm_send/2426

Sutton M.A., Oenema O., Erisman J.W., Leip A., van Grinsven H. and Winiwarter W. 2011c. Too much of a good thing. *Nature* 472, 159-161.

Integration of measures in pastoral dairy systems to mitigate reactive nitrogen loss to the environment

de Klein, C.A.M., Monaghan, R.M., van der Weerden, T.J., Chrystal J.

AgResearch Ltd, Invermay Agricultural Centre, Private Bag 50034, Mosgiel 9053, New Zealand

1. Background and objectives

There are ongoing concerns about the impact of dairying on reactive nitrogen (N) losses to the environment. Although dairy systems have become more N efficient, the rate of productivity gains has typically been faster than the rate of efficiency gains (reduced N losses per unit of product), and thus total N losses to the environment have increased. The need for integrated N efficiency solutions for dairy systems to meet the challenge of increasing global production of animal-based protein while reducing N losses to the environment has never been greater. The objectives of this paper are to provide an overview of current N efficiency and mitigation measures for pastoral dairy farm systems and to assess the impact of integrating a range of these measures on reactive N loss to the environment and on farm profitability. We also provide an assessment of the impact of tactical decision making to exploit spatial and temporal variability on nitrous oxide (N₂O) losses.

2. Current N efficiency & Mitigation measures

The best way of achieving the dual and generally conflicting goals of increased productivity and reducing N losses to the environment is to ensure we achieve 'more for less', i.e. more milk per animal or per unit of dry matter (DM) intake; or more DM per unit of N input. In addition, reactive N losses to the environment can be further reduced through the adoption of measures that minimise the N loss risk. Table 1 provides an overview of some key options.

Table 1. Summary of the key 'efficiency' or 'reduced N loss risk' measures for pastoral dairy systems (e.g. Beukes et al., 2011; Clark et al, 2011; de Klein and Monaghan, 2011; Velthof et al., 2009).

Aim	Potential options
More milk per cow or per unit DM intake	<ul style="list-style-type: none"> • Higher genetic merit animals • Lower replacement rate • Better feeding to improve body condition score at the start of calving • Better quality pasture/crops/supplements
More DM per unit of N input	<ul style="list-style-type: none"> • Low N feed • Restricted grazing to protect pastures from treading damage • Mop-up crop during fallow period • Improved fertiliser and manure management • Exploit spatial and temporal variability in pasture N response • Gibberellins while reducing N fertiliser • Nitrification inhibitors
Reduce N loss risk	<ul style="list-style-type: none"> • Nitrification and urease inhibitors • Restricted grazing to avoid urine deposition at high risk times • Exploit spatial and temporal variability in N losses (especially N₂O) • Tannin rich diet • Riparian buffers • Wetland attenuation

3. Integrating N efficiency and mitigation measures

We assessed the impact of integrating key strategic N efficiency measures for a New Zealand dairy farm system (Table 2). This assessment used the farm systems model Farmax Dairy (Bryant et al.,

2010) to predict milk production and farm profitability and the nutrient budgeting model OVERSEER (Shepherd et al., 2012) to predict N leaching and N₂O emissions.

Table 2. Summary of the characteristics of a Base dairy farm system (predominantly pasture diet) and two alternative systems designed to increase production and reduce environmental N losses. The impacts of the alternative systems on production, farm profit and N losses are given as relative changes from the Base farm

Farm characteristic	System		
	Base	Better feeding	Restricted grazing
Cows/total ha	1.9	2	2
Replacement rate %	23	18	18
Winter feed (June-Aug)	Brassica @ 9 kg DM/cow/day	Brassica @ 11 kg DM/cow/day	Pasture silage @ 12 kg DM/cow/day
Additional feed – milking platform	Summer turnips	Whole crop cereal silage + annual ryegrass	Annual ryegrass
Housing	-	-	12 hours/day from March-May and in Aug; 24 hours/day in Jun-Jul
N fertiliser, kg N/ha/yr	140	50	80
Nitrification inhibitor	No	Yes applied twice (early and late Autumn)	Yes applied twice (early and late Autumn)
Wetland below winter crop	No	Yes	No
% change from Base			
kg Milk Solids/cow		+10%	+10%
Profit, \$/ha		+14%	+12%
N leaching loss, kg/ha/yr		-6%	-50%
kg N/kg milk solids		-17%	-57%
N ₂ O emissions, kg N/ha/yr		-5%	+11%
kg N/kg milk solids		-18%	-4%

The “Better feeding” option was designed to get animals in better condition before spring calving by feeding them an extra 2 kg DM/day, calving 2 week later to provide reliable spring pasture growth and introducing annual ryegrass swards to boost production later in the season. These measures collectively helped to decrease N fertiliser requirements by more than half. The “restricted grazing” option uses a housing system to remove animals from pasture for 6 hours per day during autumn and wet spring periods. It is also used for over-wintering animals using pasture silage as the main feed source, thus avoiding the need for a winter brassica crop. Modelling indicates that milk production increased by 10% in both systems, and profit by an average 13%. The reduction in N leaching losses per ha was largest in the ‘restricted grazing’ option, but N₂O emissions per hectare increased under this option. This was largely a result of increased DM intake resulting in higher urine N excretion rates, in combination with increased losses from the housing and effluent management. However, N losses per unit of milk were all reduced compared to the Base farm.

Beukes et al. (2011) also assessed the impact of integrating N efficiency and mitigation measures on greenhouse gas emissions from New Zealand dairy systems. Although this study did not document N₂O emission or N leaching results, it did show differences in N excretion rates, which are a good indicator of differences in N₂O emissions and N leaching. Their analysis showed that reducing N fertiliser inputs from 180 to 50 kg N ha⁻¹ yr⁻¹ while using a nitrification inhibitor to increase pasture

growth by 2%, reduced urinary N excretion by about 20%. Improving cow reproductive performance or genetic merit, or taking the cows off-pasture for 12 hours/day for 2 months in autumn, reduced urinary N deposition to pasture by about 5%. When all these measures were integrated within one farm system, N excretion rates reduced by c. 30% while milk production per ha increased by 15-20% (Beukes et al., 2011).

4. Exploiting spatial and temporal variability

Nitrogen use efficiency (NUE) and N losses can be highly variable, both in space and time, due to variability in soil and climatic drivers of NUE and N loss risk. This variability could be exploited by tactical management options to further increase NUE ('more for less') or the effectiveness of mitigation options such as nitrification inhibitors ('reduced N loss risk'). For example, Shepherd et al. (2011) showed that 40-50% of urine deposited in late summer/early autumn (i.e. well before the start of the drainage season) could be lost through leaching. Therefore, targeting N mitigations early could substantially reduce the risk of N leaching, particularly in summer dry areas where pasture growth rates, and thus N uptake, are limited.

We also conducted a preliminary assessment of the impact of a tactical management option to reduce N₂O emissions. This was based on the premise that N₂O emissions are low or negligible when soils are at or below field capacity (FC; van der Weerden et al., 2012) and the hypothesis that if urine N deposition can be delayed or diverted to dry areas, N₂O emissions can be significantly reduced (Figure 1).

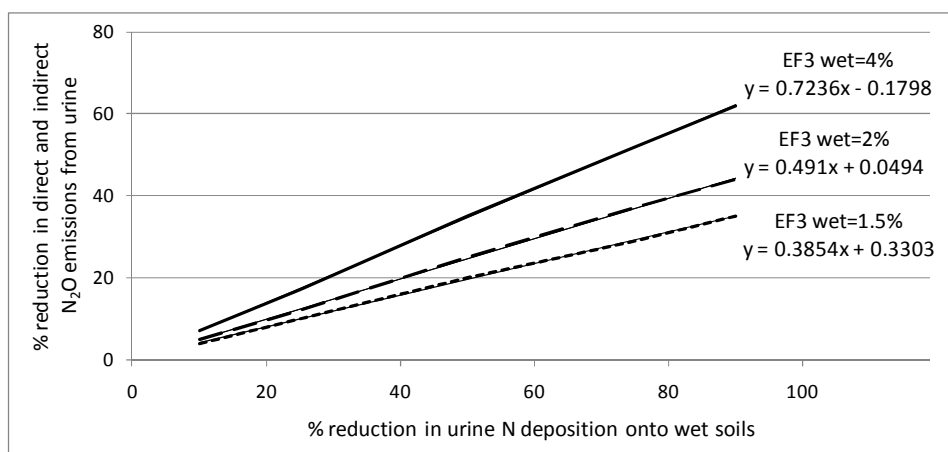

Figure 1. The effect of avoiding urine N deposition on 'wet' soil (> field capacity) on direct and indirect N₂O emissions, for three different urine N emission factors (EF3) for 'wet' conditions: 1.5, 2 and 4% of urine N applied (e.g. Ball et al., 2012; de Klein et al., 2003; van der Weerden et al., 2011), with 1.5% being a conservative value, 2% a medium value and 4% assuming that grazing on wet conditions also causes soil compaction and damage through trampling. The assumed EF3 value for deposition on 'dry' soil (\leq field capacity) was 0.5%.

We used a monthly soil water balance model (van der Weerden et al., 2011) to estimate the average number of days that New Zealand's dairy pastoral soils were above field capacity. We then combined this with monthly dairy urine N excretion rates as used in the New Zealand GHG inventory calculation to provide N excretion rates on either 'wet' (> FC) or 'dry' soil (\leq FC). Using the three different urine N emission factors (EF3) for 'wet' conditions, we estimated that N₂O emissions could be reduced by c. 4 to 7 % for every 10% reduction in urine N deposition on wet

soils (Figure 1). This very preliminary assessment suggested that there is sufficient potential for exploiting spatial and temporal variability to reduce N₂O emissions to warrant further refinement of the methodology and soil moisture-dependent EF₃ values.

5. Discussion

Modelling assessments suggest that integrating a range of strategic and tactical management and mitigation measures can reduce N losses to the environment, while maintaining or increasing milk productivity. However, experimental evidence is required to confirm the results as well as the practical feasibility of integrating these measures on farm. In addition, potential un-intended consequences need to be considered. For example, taking animals off pasture at high risk times to reduce reactive N losses requires a housing or feedpad system to enable the farmer to adopt this practice in New Zealand. The unintended consequence of this could be that farmers might use the opportunity to increase stock numbers by bringing in more supplements to maximise the return on investment. As a result, reactive N cycling in the system could be intensified and total N losses increased, although losses per unit of product are likely to be lower. Similarly, an unintended consequence of changing to animals with higher genetic merit could be that farmers retain the existing stocking rate, and thus might need to bring in more feed to maintain milk production. Again, this could potentially increase the intensity of the N cycling and total losses, but is likely to reduce losses per unit of product. A major farmlet systems research programme is currently underway in four regions in New Zealand to assess the impact of region-specific dairy systems redesign (based on options listed in Table 1) on productivity, profit, environmental losses, practical feasibility and un-intended consequences.

References

- Ball, B.C., Cameron, K.C., Di, H.J. and Moore, S., 2012. Effects of trampling of a wet dairy pasture soil on soil porosity and on mitigation of nitrous oxide emissions by a nitrification inhibitor, dicyandiamide. *Soil Use Management* (in press).
- Beukes, P.C., Gregorini, P. and Romera, A.J., 2011. Estimating greenhouse gas emissions from New Zealand dairy systems using a mechanistic whole farm model and inventory methodology. *Animal Feed Science and Technology* 166-167, 708-720.
- Bryant, J.R., Ogle, G., Marshall, P.R., Glassey, C.B., Lancaster, J.A.S, Garcı', S.C. and Holmes, C.W. 2010. Description and evaluation of the Farmax Dairy Pro decision support model. *New Zealand Journal of Agricultural Research* 53, 13-28.
- Clark, D.A., Beukes, P.C., Romera, A.J. and Chapman, D. 2011. Future farming systems. South Island Dairy Event – Challenging the future. 27-29 June 2011. Lincoln University, New Zealand pp 239-252
http://www.side.org.nz/IM_Custom/ContentStore/Assets/11/29/1675e220a3688373ef088d5eadc3c730/SIDE-Future-farming-systems.pdf
- de Klein, C.A.M., Barton, L., Sherlock, R.R., Li, Z. and Littlejohn, R.P. 2003. Estimating a nitrous oxide emission factor for animal urine from some New Zealand pastoral soils. *Australian Journal of Soil Research* 41, 381-399.
- de Klein, C.A.M. and Monaghan, R.M., 2011. The effect of farm and catchment management on nitrogen transformations and N₂O losses from pastoral systems-can we offset the effects of future intensification? *Current Opinion in Environmental Sustainability* 3, 396-406.
- Shepherd, M., Phillips, P. and Snow, V., 2011. The challenge of late summer urine patches in the Waikato region. In: Currie, L.D., Christensen, C.L. (Eds.), *Adding to the knowledge base for the nutrient manager. Occasional Report No. 24. Fertilizer and Lime Research Centre, Massey University, Palmerston North, New Zealand.*
- Shepherd, M. and Wheeler, D., 2012. OVERSEER® nutrient budgets – the next generation. In: *Advanced Nutrient Management: Gains from the Past - Goals for the Future.* (Eds L.D. Currie and C.L. Christensen) <http://flrc.massey.ac.nz/publications.html> Occasional Report No. 25. Fertilizer and Lime Research Centre, Massey University, Palmerston North, New Zealand. 9 pages.
- van der Weerden, T., Manderson, A., Kelliher, F., de Klein, C. and Harvey, M. 2011. Nitrous oxide spatial integration. Report for MAF Policy, Wellington. Pp. 66.

Velthof, G.L., Oudendag, D., Witzke, H.P., Asman, W.A.H., Klimont, Z. and Oenema, O. 2009. Integrated assessment of nitrogen losses from agriculture in EU-27 using MITERRA-EUROPE. *Journal of Environmental Quality* 38, 402-417.

Economic Cost of Nitrogen Management

Oenema, O.^a, Córdor, R.D.^b, Gyldenkaerne, S.^c, Oenema, J.^d

^aWageningen University, Alterra, P.O. Box 47, NL-6700 AA Wageningen, NL.

^bIstituto Superiore per la Protezione e la Ricerca Ambientale, ISPRA, Rome, Italy.

^cNational Environmental Research Institute, University of Aarhus, Denmark

^dWageningen University, Plant Research International, Wageningen, NL

1. Background & Objectives

Nitrogen (N) management is commonly defined as ‘a coherent set of activities related to the allocation and handling of N in agriculture to achieve agronomic and environmental/ecological objectives’ (e.g. Oenema and Pietrzak, 2002). Common agronomic objectives relate to crop yield, crop quality and animal performance, while environmental/ecological objectives commonly relate to minimizing N losses and to increasing N use efficiency (NUE). The objectives of N management are often region-, watershed-, site-, farm-, and/or field- specific. Nitrogen management is evaluated successful when objectives are achieved. Economic costs and associated risks of N management measures are often seen as an obstacle and/or delay for implementing such measures in practice (Sheriff, 2005; Oenema et al., 2011a). Indeed, management measures require additional activities and possible changes in practices, which cost money. Thereby the competitiveness of the farms may decrease. In an open, globalized market, it is necessary to establish a level playing field; otherwise producers will remain reluctant to fully implement measures that put them at a comparative disadvantage. However, there is surprisingly little empirical information about the cost and benefits of improved N management. The objective of this paper is to review available literature, which relates to developed countries.

2. Economic cost of establishing N input-output balances at farm level

Nitrogen input-output balances are key tools for monitoring the success of N management. There are various procedures for making N input-output balances, which may slightly differ in outcome, accuracy and in efforts needed to establish the input-output balance. Hence, it is important to use standardized formats for making N input-output balances, to allow comparisons between farms. Information from countries that have implemented farm N balances in practice (e.g. Denmark, The Netherlands) indicates that farmers learn easily to interpret such N balances. They may also easily learn to compile these N balances. However, in many cases N balances are compiled by accountancy offices, which charge farmers on average 250-500 euro per farm per year for farm N & P balances (e.g. Jacobsen et al., 2005). In the Czech Republic, the estimated costs of farm N & P gate balances are in the higher end of this range, because of poor data availability.

3. Assessing economic cost of decreasing N surpluses and increasing NUE

Estimating the economic costs of N management activities can be done at various scales. Estimates at farm level provide an integral account and tend to be lower than the summed costs at field and/or farm compartment levels, due to compensation effects. Estimates at sector level include the indirect economic effects for suppliers and processing industries, which can be significant when N management activities at the farm significantly change farm inputs and/or outputs. Finally, cost-benefit analyses at national or society level basically integrate all effects, the cost of the N management activities as well as the benefits to society of lower N surpluses and higher NUE (e.g. Brink et al., 2011). Estimating costs of N management activities at farm level can be done through longitudinal comparisons of one or few similar farms over time or through comparisons of different farms with and without improved N management. Effects of N management activities are monitored over time in the first case, while differences between farms in N management activities are analyzed statistically in the second case. The cost of improving N management highly depends on the reference situation; on farms with poor nutrient management

it is often highly beneficial to lower N surpluses (Ondersteijn et al., 2003). On the other hand, efficiently managed farms generally have good economic and environmental performances, and may not easily decrease N surplus and increase NUE further. Evidently, the law of diminishing returns applies to N management in agriculture.

4. Economic costs of N management activities on arable and vegetable farms

Nitrogen management activities on arable farms relate to maximizing the N output (i.e., yield) and maximizing the utilization of available N sources, using the right method, time and amount of application. Maximizing yield involves using the proper genetic crops and optimal crop husbandry. The economic cost of selecting the appropriate timing, method and rate are relatively small, but the implementation of these best management practices is still modest. Sheriff (2005) examined why farmer perceptions of agronomic advice, input substitutability, hidden opportunity costs, uncertainty, and risk aversion can make it economically rational to “waste” fertilizer by applying it above agronomically recommended rates. The costs of N fertilizer in proportion to the total production costs may range from 20-30% on large cereals farms to 1-5% on farms specialized in growing seed potatoes, vegetables and flowers (Pederson et al., 2005; Van Dijk et al., 2007; Jensen et al., 2011). The relatively low cost of N use for high-value crops is one of the reasons for its liberal use in these crops, and for the relatively high N surpluses and low NUE (Jensen et al., 2011). Costs and benefits of improved N management relate to (i) decreasing over-fertilization, (ii) increasing the effectiveness of N applied via fertilizers, manures, composts, i.e., use the right method and time of application, and (iii) increasing crop yield through selection of high-yielding crop varieties and optimal crop husbandry. The net costs are highly depending on crop type, but are usually in the range of -0.5 to +2 euro per kg N saved, which translates to -5 to 25 euro per ha (Van Dijk et al., 2007; Mikkelsen et al., 2010).

5. Economic costs of N management activities on dairy farms

Empirical information on the relationship between farm management, N surplus and financial consequences on dairy farms has been collected by Rougaar et al. (1997), Ondersteijn et al. (2003), Doornewaard et al. (2007) and Daatselaar et al. (2010). A major conclusion of these studies is that improved management leads to improved efficiency and to improved financial results, though within certain boundaries. Similar conclusions have been reached by Powell et al., (2009; 2010) and Rotz (2003) for dairy farms in the USA. Improving the utilization of nutrients from manure while decreasing the use of synthetic fertilizers is cost-effective measure to decrease N surplus and increase NUE.

6. Economic costs of N management activities on specialized pig and poultry farms

Landless pig and poultry farms basically import all animal feed and export animal products and manure. Activities related to improving N management on these farms include (i) low protein, phase-feeding, (ii) herd management (genetic selection, reproduction and disease management), (iii) low-emission housing system and (iv) low-emission manure storage, treatment and export. Economic cost of these activities can be very high, up to 10% of total running costs and more. To cover, these costs, farms have to excel in productive performances and in scale.

7. Conclusions

Empirical information on economic cost of improving N management is scarce. Benefits seem largest for mixed farms, while costs are highest for landless pig and poultry farms. There is need for further studies, collecting and analyzing empirical information on economic cost of improving N management, both through longitudinal comparisons and through comparisons of farms with and without improved N management.

References Available on request to authors (oenema@wur.nl).

Beer, bread and other opportunities for innovation in nitrogen use

Sylvester-Bradley, R.^a

^aADAS UK Ltd., Battlegate Road, Boxworth, Cambridge, CB23 4NN, UK

1. Proposition

The paradox is frequently cited between improving crop productivity and reducing inputs of nitrogen (N), thereby reducing N emissions (Berry et al., 2011). However, despite the evident urgency, commercially viable resolutions are hard to envisage.

N requirements of high yielding crops (e.g. cereals yielding $>9 \text{ t ha}^{-1}$) are primarily due to the N in their harvested products, but also to the N fertility of soils and the inefficiencies of fertilisers or manures used in their production. The pace of innovation in crop N management, crop N requirements or in N fertiliser efficiency has been poor thus far. Key factors governing fertiliser N requirements were recognised at least 75 years ago; yet little of the known wide variation in requirements is predicted by current decision-support systems, commercial cultivars have yet to be bred for reduced N requirements, and most N is still sprinkled onto soils as simple salts with no conditioning and poor targeting. In consequence, crop recovery of fertiliser N is always partial, whilst most of the N sold to end users is subsequently wasted or excreted. By considering the path of N through to end use (Figure 1), and the recycling of N, points with potential for innovation become apparent, the most telling and crucial being in end-use.

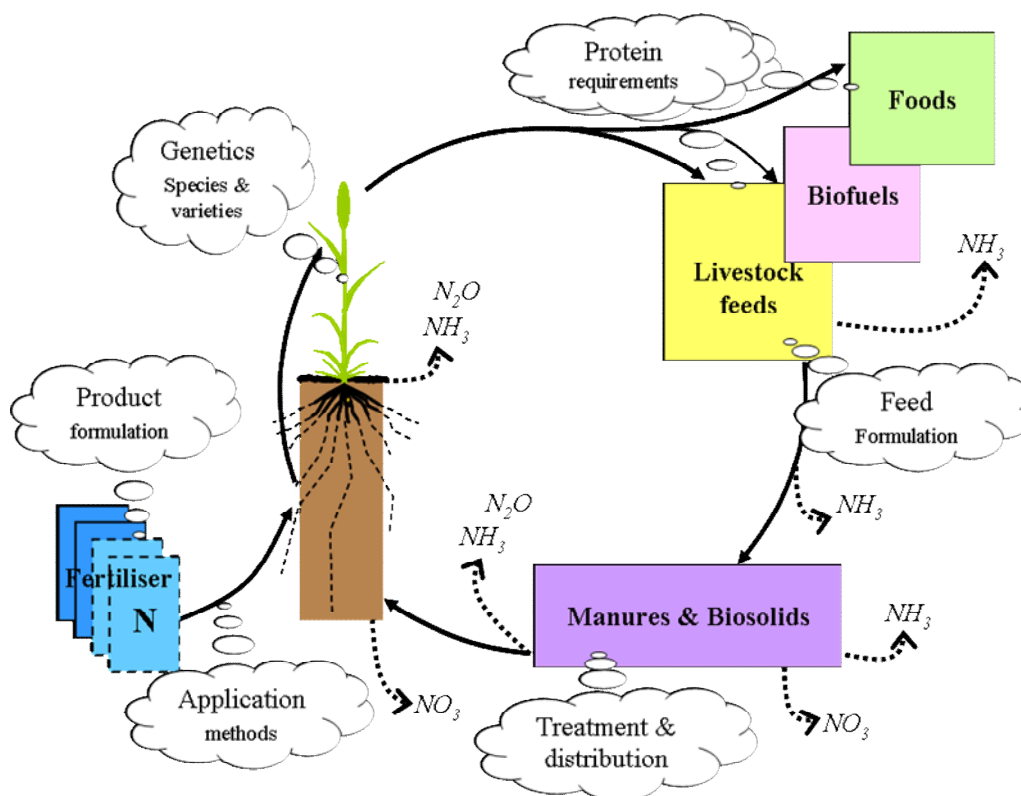

Figure 1. Anthropogenic cycling of nitrogen with 'thought bubbles' indicating opportunities for innovations to reduce inputs, hence waste and environmental pollution.

2. Evidence

Requirements for protein (or N) in foods, feeds, fibres and biofuels are poorly defined and sparsely monitored. Indeed, prices offered for crop products seldom depend on their N contents. Two contrasting exceptions are in grain for the production of bread and beer where, to attract premium prices, grain must contain more than 2.25% N (HGCA, 2011) or less than 1.65% N (magb, 2011) respectively. This contrast has had significant effects on use of fertiliser N for wheat and barley, and on the effects of breeding on N their contents, such that wheat's N requirements have increased in line with yields whereas barley's N requirements have not increased (Figure 2; Sylvester-Bradley and Kindred, 2009). This supports the notion that, in a commercial context, there is no essential association between crop yields and N requirements, hence that end users may reduce the economic and environmental costs of their feedstocks by specifying reduced N contents. For example biofuel producers could benefit from specifying low protein feedstocks (Smith et al., 2006) and it is eminently feasible for bread to be made from wheat with less N than 2.25%.

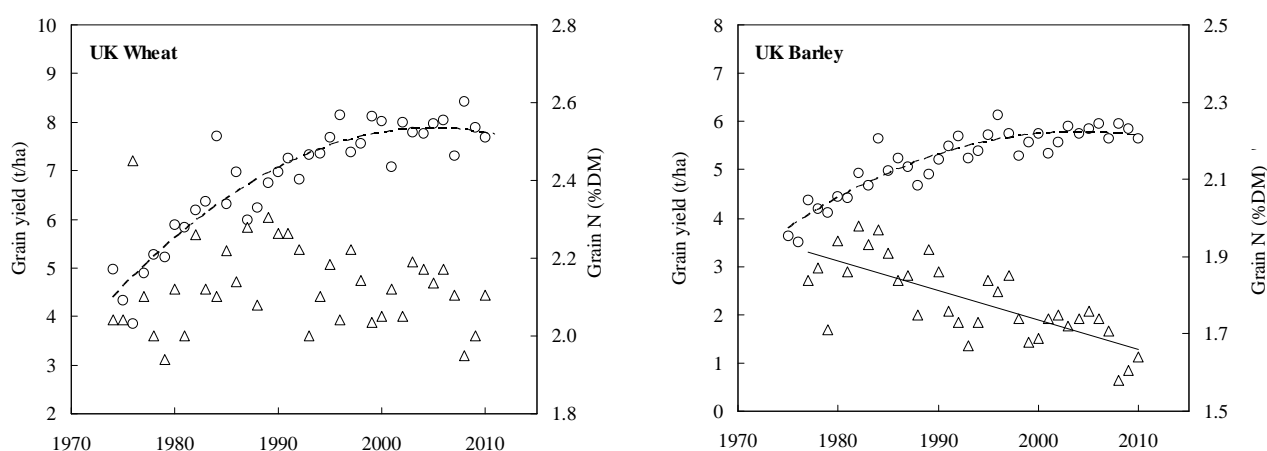

Figure 2. Grain yields (circles) and grain N contents (%DM; triangles) of wheat and barley in the UK since the 1970s (Survey data from Defra and HGCA websites). Axes for wheat and barley are scaled identically. Significant trends (linear or quadratic) are shown; there is no significant trend for wheat grain N.

3. Summary

Reducing end-use requirements for N could have significant repercussions for the way that crops are bred, grown and fertilised. Whilst protein (or N) content is not included within specifications for most crop products, opportunities exist for their introduction. Strategies to enhance sustainable crop productivity should seek to introduce and improve specifications for N in foods and feeds, as well as addressing the use of fertiliser N more directly through crop and fertiliser improvement.

References

- Berry, P.M., Sylvester-Bradley, R. and Weightman, R. 2011. Yield potential of combinable crops in the UK. *Proceedings of the International Fertiliser Society* 697, 1-17.
- HGCA. 2011. Milling wheat – quality criteria and tests. Sourced at www.hgca.com/publications/documents/varieties/milling_wheat.pdf
- magb (The malsters association of Great Britain). 2011. Controlling the intake of malting barley to UK maltings. Sourced at: www.ukmalt.com/maltingbarley/controlintake.asp
- Smith, T.C., Kindred, D.R., Brosnan, J.M., Weightman, R.M., Shepherd, M. and Sylvester-Bradley, R. (2006). Wheat as a feedstock for alcohol production. *HGCA Research Review* No. 61, 88 pp.
- Sylvester-Bradley, R. and Kindred, D.R. 2009. Analysing nitrogen responses of cereals to prioritize routes to the improvement of nitrogen use efficiency. *Journal of Experimental Botany* 60, 1939-1951.

Using NDVI to define optimal N rate: an application on durum wheat

Loddo, S.^a, Morari, F.^a, Sartori, L.^b, Berti, A.^a and Mosca, G.^a

^aDept of Agronomy Food Natural resources Animal and Environment, University of Padua;

^b Dept of Land Environment Agriculture and Forestry, University of Padua, Italy.

1. Background & Objectives

In the past decade, identification of optimal N rate has become a crucial issue in wheat cultivation, since the breeders' goal to increase protein content has contrasted with the effort to limit N input (Sylvester-Bradley and Kindred, 2009). Use of uniform N rates at field scale generally leads to exceed actual crop requirements (Lobell et al., 2004) thus soil spatial variability should be accounted to enhance nitrogen use efficiency. Spectral indexes are useful tools to assess N status of crops and optimize fertilization, in particular for small grain cereals (Raun et al, 2001; Zilmann et al., 2006). In this experiment a normalized difference vegetation index (NDVI) was used to set up a reference scale for nitrogen application in durum wheat. An algorithm for N input correction was implemented and its results were compared to the actual fertilisation applied in field.

2. Materials & Methods

In 2010-2011, a 13.6 ha field was cropped with durum wheat in Northern Italy (Mira, 45°22'N, 12°08'E). Soil properties were strongly variable (e.g. higher sand content and poor organic matter in South-Eastern corner (Figure 1-a)). In the field, 3 management zones were identified and subjected to 6 site-specific nitrogen treatments: 130, 160 and 200 kg N ha⁻¹ (at tillering and stem elongation) or the same N rates with additional 15 kg N ha⁻¹ by late foliar treatment. To set a reference scale, NDVI (Greenseeker, Ntech Industries, CA-USA), biomass production and N uptake were measured from tillering to flowering in 1 m² plots (in total 18 areas across the field). In 4 dates during spring season, Greenseeker associated to a DGPS was also used to measure NDVI along 15-m wide transects (in total ~6000 points). Grain yield and protein content sensors were installed on a combine harvester to acquire data across the field (>3000 points in 13.6 ha). Spatial information was extended to the field with Kriging technique. A recommendation map for N application was produced from NDVI map and compared to N rates actually applied in the management zones.

3. Results & Discussion

NDVI sampled in 1 m² plots was highly correlated with N uptake ($R^2 = 0.8821$; $n = 75$; $P < 0.001$). A single exponential equation [1] described this relationship from tillering to flowering. Senescent plots were excluded from model to avoid to underestimate N content. RMSE was low enough (22.1 kg ha⁻¹) to encourage the use of spectral index to forecast N uptake. Optimal NDVI curve was estimated by calculating the 90th percentile for each sampling date. Values were plotted against thermal-based time scale (base temperature 0°C) and an inverse exponential model [2] identified optimal NDVI across all durum wheat growth cycle. Highest value was found at the booting stage.

$$N \text{ uptake} = 2.404 \cdot e^{(5.43962 \cdot NDVI)} \quad [1]$$

$$\text{Optimal NDVI} = \frac{1}{1.77 \cdot 10^{-6} \cdot GDD^2 - 5.61 \cdot 10^{-3} \cdot GDD + 5.68} \quad [2]$$

A recommendation N fertilisation map was calculated from NDVI map of 7th April (onset of stem elongation, Figure. 1-b) as follow: a) the difference between the optimal NDVI and the real NDVI was converted in N uptake deficit using equation [1]; b) the N uptake deficit was added to the base fertilisation (105 kg ha⁻¹) which was estimated to be needed to maximise N uptake at the end of

growth cycle in normal conditions. NDVI-based recommendation (NDVI-rec) was compared to actual fertilisation (Figure 1-c). Highest grain yield (7.9 t ha⁻¹) and N uptake (Figure 1-d) were observed in plot 160+15, where accordance between NDVI-rec and real N rate was high. In plot 130+0 actual N rate was lower than NDVI-rec, highlighting N deficiency conditions. These were also confirmed by the poorer crop performances obtained in a management zone characterised by higher soil quality (e.g. lower sand content, higher SOM). Very low yield (4.8 t ha⁻¹) and thus N offtake (Figure 1-d) were observed in 200+15 management zone: water stress, worsened by the lower water retention capacity (i.e. sandy soil), limited crop yield. Apparent N balance was therefore in dramatic excess (Figure 1-e). In the sandy area, NDVI measurements were ineffective to optimise N applications since they were carried out before the unforeseeable water stress events.

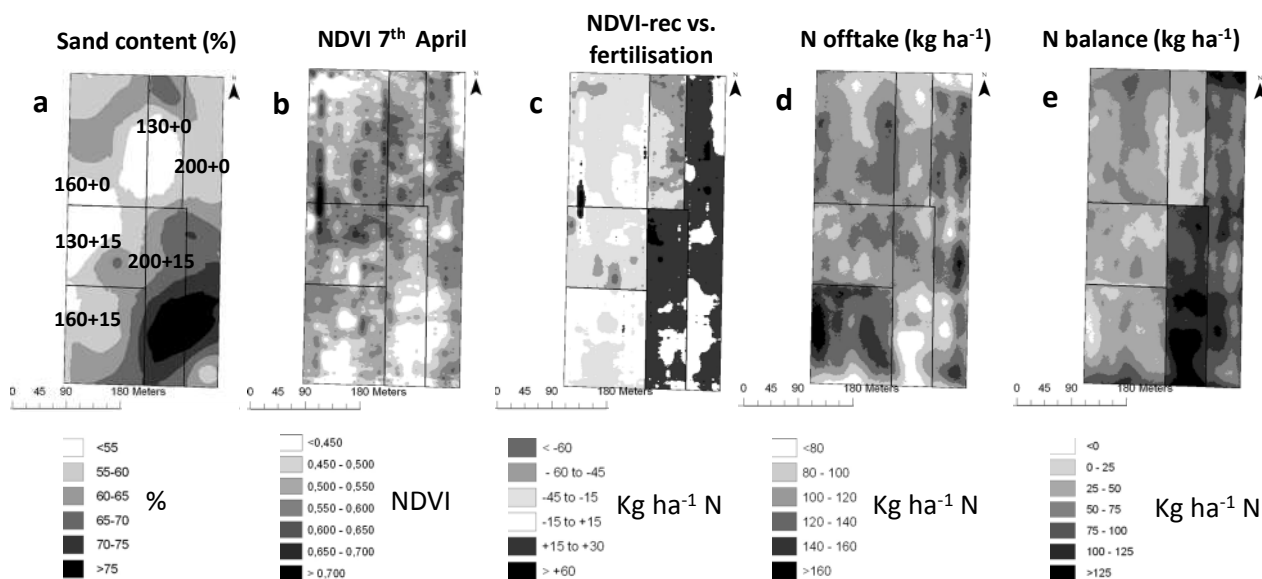

Figure 1. Maps of soil sand content (a), NDVI at the beginning of stem elongation (b), difference between NDVI-based and actual N rate (c), N offtake of grains (d) and apparent N balance (e).

4. Conclusion

As observed in a previous study (Zillman et al., 2006), if no other stresses than N availability occur, NDVI-based N recommendation matches crop requirements. These results evidence the possibility to apply on durum wheat sensor-based input correction, extending it to a wide area in Southern Europe. Difficulties are still encountered to outline optimum N rate in sandy soils which are more sensitive to meteorological variability.

References

- Lobel, D.B., Ortiz-Monasterio, J.I.O and Asner, G.P. 2004. Relative importance of soil and climate variability for nitrogen management in irrigated wheat. *Field Crops Res.* 87, 155-165.
- Raun, W.R., Solie, J.B., Johnson, G.V., Stone, M.L., Mullen, R.W., Freeman, K.W., Thomason, W.E. and Lukina, E.V. 2002. Improving nitrogen use efficiency in cereal grain production with optical sensing and variable rate application. *Agron. J.* 94, 815-820.
- Sylvester-Bradley, R. and Kindred, D.R. 2009. Analysing nitrogen responses of cereals to prioritize routes to the improvement of nitrogen use efficiency. *J. Exp. Bot.* 60, 1939-1951.
- Zillmann, E., Graeff, S., Link, J., Batchelor, W.D. and Claupein W. 2006. Assessment of cereal nitrogen requirements derived by optical on-the-go sensors on heterogeneous soils. *Agron. J.* 98, 682-690.

Processes of nitrate-N loss to streamflow from intensive cereal crop catchments in Ireland

Melland, A.R.^a, Mellander, P-E.^a Murphy, P.N.C.^a, Wall, D.P.^a, Mehan, S.^a, Shine, O.^a, Shortle, G.^a, Jordan, P.^b

^aAgricultural Catchments Programme, Teagasc, Johnstown Castle, Environmental Research Centre, Co Wexford, Rep. of Ireland

^bSchool of Environmental Sciences, University of Ulster, Coleraine, N. Ireland

1. Background & Objectives

Whilst cereal crops constitute only 7% of land use in Ireland, yields are amongst the highest in the world (Spink and Kennedy, 2012) and food production targets require yields to be sustained or increased into the future (Anon., 2010). At the same time, EU Water Framework Directive water quality targets must be met. Losses of total oxidised nitrogen (TON) to stream water in two intensive arable catchments with contrasting hydrological characteristics were monitored within an Agricultural Catchments Programme (Wall et al., 2011) to help identify opportunities for environmentally sustainable yield increases.

2. Materials & Methods

Monitoring was conducted from October 2009 to September 2011 in a 9.5 km² catchment with predominantly well-drained soils and 45% of land use under spring barley (Arable A), and in a 11.2 km² catchment on moderate to poorly-drained soils (Arable B) farmed for winter wheat and barley (24%) and dairy and beef (47%). Monthly spatial surveys of stream and surface ditch nitrate-N concentrations were conducted. Groundwater was sampled monthly at multiple depths from 1 to 52 m below ground along two representative hillslope transects within each catchment. Stream discharge and TON concentrations were measured on a sub-hourly basis at the catchment outlet using a flow-rated water level recorder for discharge and an *in situ* calibrated UV sensor for TON.

3. Results & Discussion

In Arable A, stream outlet TON concentrations were diluted in elevated flows and baseflow concentrations remained relatively stable and below drinking water standards (Figure 1a). There was little spatial variation in stream water nitrate-N concentrations and the concentrations reflected those in connected near-stream and midslope groundwater (Figure 2a). In Arable B, TON concentrations were also diluted during elevated flow. Surprisingly, given the moderate-poorly drained nature of much of the catchment, and therefore a lower potential for N leaching, baseflow TON concentrations were similar to those in Arable A during winter (Figure 1b). During spring and summer, however, TON concentrations decreased markedly. There was a trend for decreasing stream nitrate-N concentrations towards the catchment outlet and neither groundwater nor tributary nitrate-N concentrations were reflected in the stream water concentrations (Figure 2b). Instead, it was hypothesised that a 'critical source' sub-catchment area, where springs and ephemeral surface ditches rich in nitrate-N emerged, contributed nitrate to the stream. It was hypothesized that nitrate-poor groundwater from upper landscape areas emerged in low-lying areas over poorly-drained gley soils and interacted with rootzone N before discharging to ditches and the stream. The seasonally low concentrations in Arable B were attributed to seasonal disconnection of these localised N sources. It is less likely that lower stream TON concentrations were due to depleted rootzone N during the growth season because the ephemeral nature of the monitored ditch, and the low temporal variance in high concentrations from the perennial spring, would not support this hypothesis. Annual stream loads of TON varied from 15.5 to 34.7 kg ha⁻¹ across the catchments. The potential downstream ecological impact of the observed TON loads requires investigation.

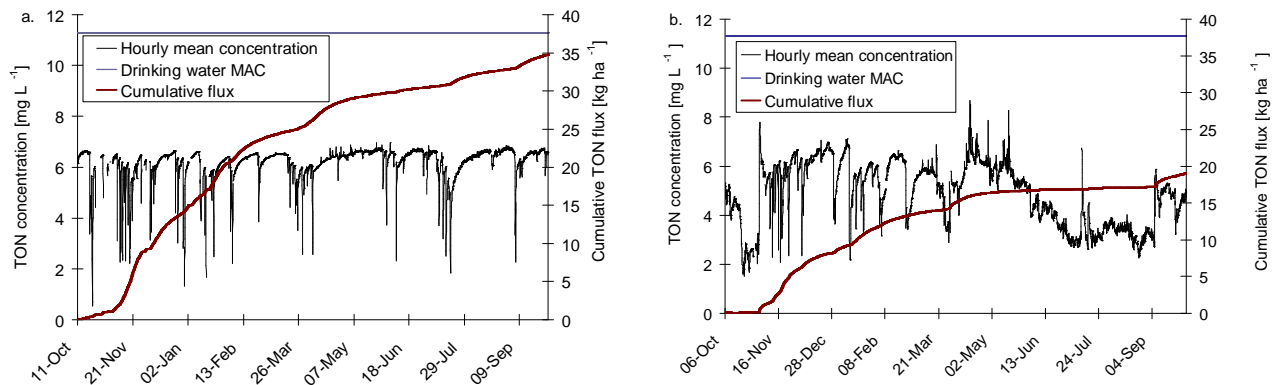

Figure 1. Hourly mean TON concentrations (mg L^{-1}) and cumulative load (kg ha^{-1}) for a) Arable A and b) Arable B. Drinking water maximum acceptable concentration (MAC) is shown.

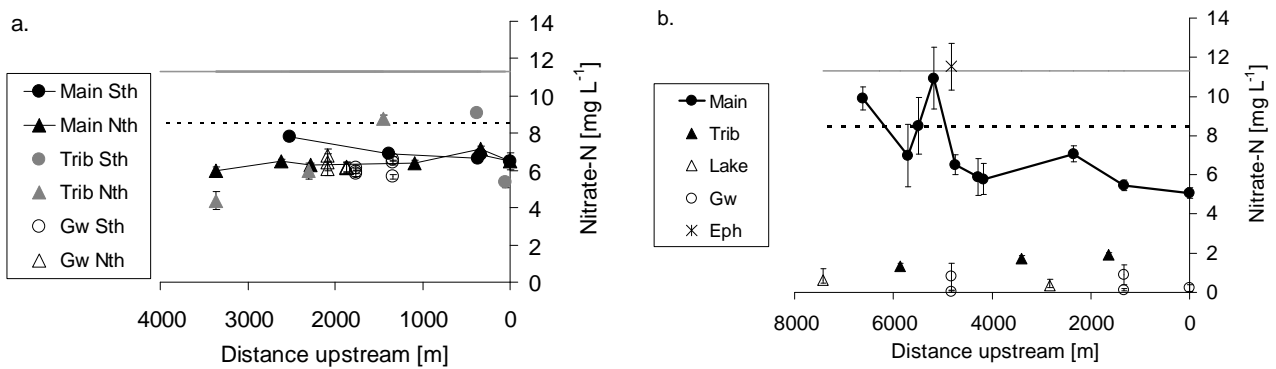

Figure 2. Monthly mean and standard error nitrate-N concentrations (mg L^{-1}) of stream water in the main streams (main), tributaries (Trib), ephemeral ditches (Eph), lake outfalls (Lake) and near-stream and midslope groundwater (Gw), at representative sites upstream of the catchment outlets in a) Arable A and b) Arable B. Drinking water (solid line) and groundwater (dashed line) maximum acceptable concentrations are shown

4. Conclusion

Whilst the ecological impact of observed TON loads on downstream estuarine waters is not known, the processes of TON loss indicated that in both catchments further reductions in TON transfer to streams would require depletion of diffuse N stores that are connected to the stream. It was hypothesized that these N stores were localised in near-surface depths of a critical N source area in the mixed soil type catchment of Arable B, and that N stores were catchment-wide in the subsoil of Arable A.

Acknowledgement

We acknowledge funding from the Irish Department of Agriculture Food and Marine.

References

- Anon. 2010. Food Harvest 2020. Department of Agriculture Fisheries and Food, Dublin, Ireland.
- Spink, J. and Kennedy, S. 2012. Explaining cereal yields in 2011 In National Tillage Conference 2012, Teagasc, 25th January 2012. p 17-25, Carlow, Ireland.
- Wall D, Jordan P, Melland AR, Mellander P-E, Reaney S. and Shortle G. 2011. Using the nutrient transfer continuum concept to evaluate the European Union Nitrates Directive National Action Programme. Environmental Science & Policy 14, 664-674.

GHG balance of bioenergy cropping systems under the environmental conditions of northern Germany

Claus, S.^a, Wienforth, B.^b, Svoboda, N.^c, Sieling, K.^b, Kage, H.^b, Senbayram, M.^d, Dittert, K.^e, Taube F.^a, Herrmann A.^a

Christian-Albrechts-University of Kiel, Kiel, Germany

^aInstitute of Crop Science & Plant Breeding, Grass and Forage Science/Organic Agriculture

^bInstitute of Crop Science & Plant Breeding, Agronomy and Crop Science

^cLeibnitz Centre for Agricultural Landscape Research, Müncheberg, Germany

^dYARA GmbH & Co. KG, Dülmen, Germany

^eGeorg-August-Ernst University of Göttingen, Institute of Applied Plant Nutrition, Göttingen, Germany

1. Background & Objectives

Due to a considerable expansion of biogas plants (500 mid of 2011) and the resulting expansion of maize production, criticism on biogas production and its GHG mitigation potential has been voiced recently. Although various studies on Life Cycle Assessment (LCA) of biogas production are available, the majority are estimates only based on literature data, especially with regard to greenhouse gas (GHG) balance. Furthermore, data for northern Germany are generally limited. To overcome these limitations a 2-year field trial was conducted to evaluate the GHG mitigation potential and to generate a GHG balance for a LCA to come.

2. Materials & Methods

A 2-year field trial (2007-2009) was conducted at two experimental sites of Kiel University: Hohenschulen (HS) and Karkendamm (KD). The annual precipitation at HS averages 750 mm with a daily temperature of about 8.3°C. The soil is classified as a pseudogleyic Luvisol of sandy loam structure. The annual precipitation at KD averages 844 mm with a daily temperature of about 8.3°C. The soil is classified as a gleyic Podzol of sandy sand structure. Altogether three cropping systems have been investigated: maize monoculture and a maize–whole crop wheat–Ital. ryegrass rotation at HS, while maize monoculture and a four-cut permanent grassland were tested at KD. The plots were laid out in a randomised block design. N-fertiliser was applied at four levels (maize, wheat: 0, 120, 240, 360 kg N ha⁻¹; grassland: 0, 160, 320, 480 kg N ha⁻¹) and different N types: calcium ammonium nitrate (CAN) and biogas residue from co-fermentation. GHG balances were calculated according to the life cycle inventory analysis provided by the ISO guidelines 14044 (2006). The calculations are based on the energy balance by Claus et al. (2010), direct N₂O emissions presented by Senbayram et al. (2009) and estimates of indirect N₂O emissions based on measurements of NH₃ emissions by Gericke (2009). All measurements were taken on the above named field sites. Changes in soil carbon stocks have been considered according to German cross compliance commitments. For conversion a biogas plant (500 kW), with an electric efficiency of 40%, a thermal efficiency of 41.5% and a heat utilization of 45% was assumed. Energy demand for plant operation was assumed to be 20% of the generated electricity for heat and 7.5% for electricity. The relation of N input to total emission of CO₂eq. from electricity and heat generation was quantified by an exponential function. The GHG emissions of energy production from biogas were compared to a reference system based on fossil sources (electricity: 0.72 kg CO₂eq./kWh, heat: 0.31 kg CO₂eq./kWh).

3. Results & Discussion

The comparison of cropping systems at Hohenschulen revealed noticeably higher GHG

emissions for the production of energy and heat from maize monoculture than from the maize–whole crop wheat–Ital. ryegrass rotation (Figure 1a). In agreement, higher total GHG emissions were found for maize monoculture than for permanent grassland at Karkendamm (Figure 1b). The higher emissions were caused by much higher N_2O fluxes during maize cultivation (Senbayram et al., 2009). Due to higher dry matter yield, however, maize monoculture resulted in highest GHG saving potential at both experimental sites, as also reported by Gerin et al. (2008).

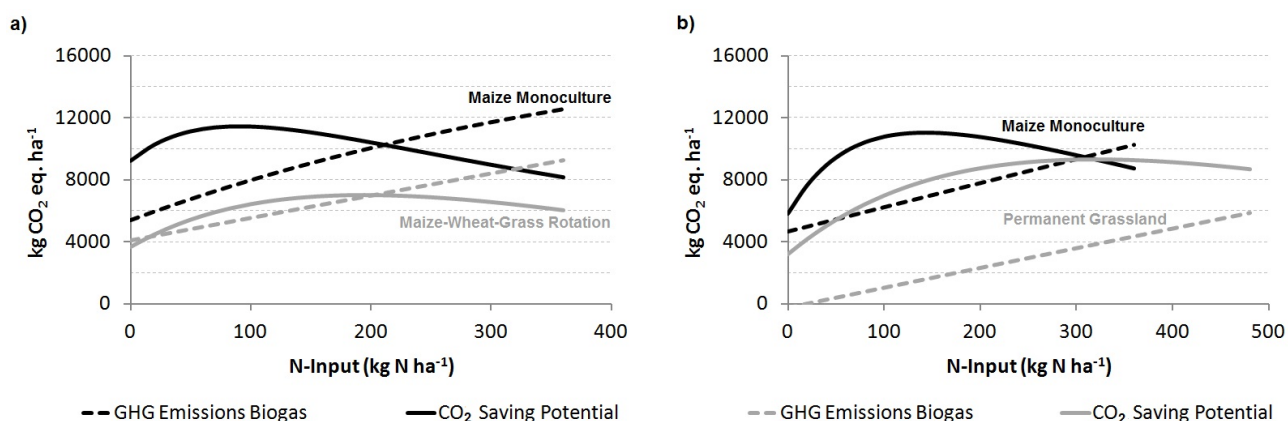

Figure 1. Lines of best fit for relationships between total N-input of CAN ($kg N ha^{-1}$), $CO_2eq.$ emission for the production of energy by biogas and $CO_2eq.$ emission saving potential as influenced by cropping system at (a) Hohenschulden and (b) Karkendamm.

The comparison of fertiliser types showed less pronounced differences for the emission of greenhouse gases (not shown). In contrast to N type, the experimental site had a considerable impact. GHG emissions of maize monoculture grown at HS exceeded those at KD by $2000 kg CO_2 eq. ha^{-1}$. This could be traced back to a soil texture effect, where at the loamy soil site Hohenschulden N_2O emissions were at least 3 times higher than at the sandy soil site Karkendamm (Senbayram et al., 2009).

4. Conclusion

Considering the whole production chain, maize monoculture revealed a higher GHG mitigation potential than the other systems investigated. The type of N-fertilizer had no impact on the GHG emission and mitigation potential, whereas a pronounced influence of local soil conditions was observed.

References

- Claus, S., Wienforth, B., Sieling, K., Kage, H., Taube, F. and Herrmann, A. 2011. Energy balance of bioenergy cropping systems under the environmental conditions of Schleswig-Holstein. In: Grassland Farming and Land Management Systems in Mountainous Regions. Grassland Science in Europe 16, 365-367.
- DIN NORM EN ISO 14044 2006: Umweltmanagement - Ökobilanz - Anforderungen und Anleitungen
- Gericke, D. 2009: Measurement and modelling of ammonia emissions after field application of biogas slurries. Doctoral thesis, Christian-Albrechts-Universität zu Kiel, Germany.
- Gerin, P., Vliegen, F. and Jossart, J. 2008. Energy and CO_2 balance of maize and grass as energy crops for anaerobic digestion. Bioresource Technology 99, 2620-2627.
- Senbayram, M., Chen, R., Mühling, K.H. and Dittert, K. 2009. Contribution of nitrification and denitrification-derived nitrous oxide emissions from soil after application of biogas waste compared to other fertilizers. Rapid Communication in Mass Spectrometry 23, 2489-2498.

Animal delivery of the nitrification inhibitor DCD as a new effective method for reducing nitrogen losses from grazed pastures

Ledgard, S.F., Welten, B.G., Luo, J.

AgResearch Ruakura Research Centre, Private Bag 3123, Hamilton 3240, New Zealand

1. Background & Objectives

Nitrification inhibitors can be used to reduce the conversion of ammonium to nitrate in soil, thereby reducing the potential for nitrogen (N) losses by nitrate leaching and nitrous oxide (N₂O) emissions (e.g. Amberger, 1989). In New Zealand the nitrification inhibitor DCD is now being used commercially on dairy farms by broadcasting it onto grazed pasture within about one week of grazing over the winter period when the risk of N losses is high. The aim of this is that it can act on urine-N excreted by animals, which is the major source of both nitrate leaching and N₂O emissions. Ledgard et al. (2008) developed the concept of administering the DCD directly to animals so that it is excreted in the urine patches by animals and so can act directly on reducing losses from the urine-N. This makes it a more targeted method that requires less DCD in total and is potentially much more cost-effective. Previous research indicated that most of the DCD administered to sheep or cattle was excreted in urine in an unaltered form (Ledgard et al., 2008). The objective of this paper is to present research on evaluation of this approach by application of DCD in water troughs for consumption by dairy cows to reduce N losses from urine excreted on grazed pastures in autumn/winter.

2. Materials & Methods

A grazing system trial on ryegrass/white clover pasture in the Waikato region of New Zealand was set up with two treatments. One was the standard practice on the dairy farm and the other was the same except that dairy cows were given access to a water trough in which DCD was added. The rate of DCD addition was based on a review of typical water intake and the rate of DCD required in relation to the typical urination volume, frequency and affected area. Two groups of dairy cows (20/treatment) separately grazed 12 pairs of randomly-allocated plots (c. 630 m²) corresponding to the two treatments as part of their standard rotation on the farm. The cows went through two grazing rotations in late-autumn and late-winter. Measurements included: i. assessment of the rate of DCD returned in urine patches. This was based on identification of urine patches after deposition and soil sampling to determine the rate of DCD returned in the urine patches. ii. nitrate leaching using ten ceramic cup samplers per plot (i.e. 120 per treatment) and collection of leachate at intervals corresponding with approximately 50 mm drainage for analysis of inorganic N. Drainage volume was estimated using water budget modelling. iii. N₂O emissions measured at regular intervals using randomly allocated cover plots within each treatment over time after grazing events.

3. Results & Discussion

Regular daily observation of cow urination and soil sampling of urine patches showed that the DCD was returned in the urine patches across a range of rates that represented a skewed (upper tail) distribution. The median rate of DCD in the urine patches varied with weather conditions and was generally in the range of 15-45 kg DCD ha⁻¹.

Nitrate concentrations in leachate collected from the ceramic cups were significantly lower in the DCD-treatment plots than in the control over the winter drainage period

(Figure 1). This resulted in annual values of nitrate-N leaching of 19.2 vs. 32.0 kg ha⁻¹ (P<0.05) for the DCD-treatment and control farmlet systems, respectively.

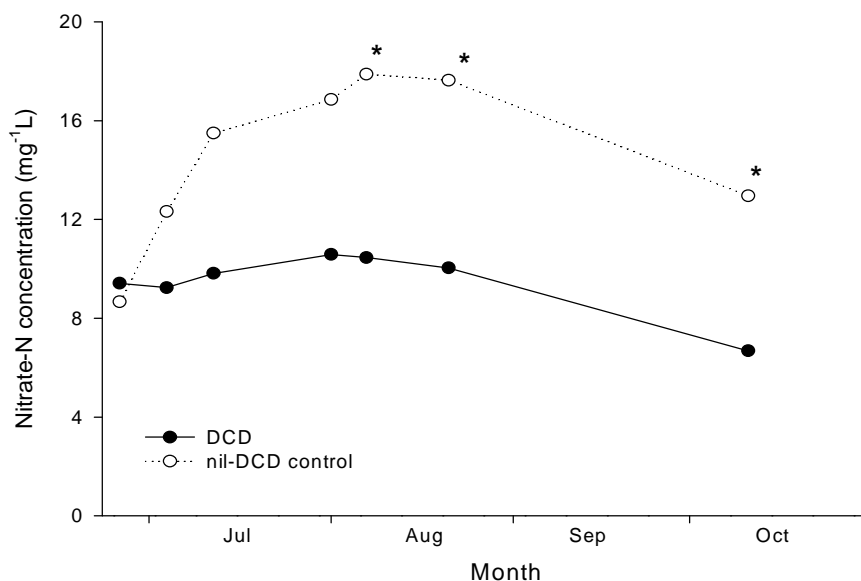

Figure 1. Nitrate-N concentration (mg L⁻¹) in soil solution at 60 cm depth for nil-DCD control and DCD treatments. Significant treatment differences are indicated by * and represent P<0.05.

Nitrous oxide emissions showed significant treatment differences over approximately six weeks and during the main winter period (June-August). They were 44% (P<0.05) lower for the DCD treatment.

4. Conclusion

This grazing system study showed that DCD can be administered to water troughs, consumed by grazing cattle and delivered in an unaltered form predominantly in urine. This resulted in a significant reduction in nitrate leaching (by 40%) and nitrous oxide emissions (44%) from the DCD treatment relative to the control.

References

- Amberger, A. 1989. Research on dicyandiamide as a nitrification inhibitor and future outlook. *Communications in Soil Science and Plant Analysis* 20, 1933-1955.
- Ledgard, S.F., Menneer, J.C., Dexter, M.M., Kear, M.J., Lindsey, S., Peters, J.S. and Pacheco, D. 2008. A novel concept to reduce nitrogen losses from grazed pastures by administering soil nitrogen process inhibitors to ruminant animals: A study using sheep. *Agriculture, Ecosystems and Environment* 125, 148-158.

2 SESSION

*A Holistic Approach to Understanding Impacts of
Nitrogen on the Environment*

Poster Presentations

A synergistic mitigation technology for nitrate leaching and nitrous oxide emissions for pastoral agriculture

Di, H.J.^a, Cameron, K.C.^a, Roberts, A.^b

^aCentre for Soil and Environmental Research, PO Box 84, Lincoln University, Lincoln 7647, Christchurch, New Zealand. ^bRavensdown, P O Box 608, Pukekohe, New Zealand

1. Background & Objectives

In grazed grassland, most of the nitrate (NO_3^-) leaching and nitrous oxide (N_2O) emissions come from the animal urine-N returned to the pasture by the animal during outdoor grazing (Di and Cameron, 2002a). The N loading rate under a dairy cow urine patch in intensively grazed dairy grassland can be as high as $1000 \text{ kg N ha}^{-1}$ (Di and Cameron 2002a). Most of the N in the urine is urea which, when deposited onto the soil, is oxidized to ammonium (NH_4^+), and then to NO_3^- . The excess NO_3^- remaining after plant uptake or immobilisation is prone to leaching during the wet season or lost as N_2O . Here we present a mitigation technology that is synergistic in decreasing both NO_3^- leaching and N_2O emissions, while at the same time, increasing pasture production. The mitigation technology involves the use of a nitrification inhibitor, dicyandiamide (DCD), to treat grazed pasture soil (Di and Cameron, 2002b; 2003; 2004; 2005; 2006; 2007; Di et al., 2007; 2009a; 2009b; 2010a; 2010b).

2. Materials & Methods

Soil samples (0-0.1 m depth) were taken from different sites across New Zealand and were used to study the inhibition effect of DCD on ammonia oxidizing bacteria (AOB) and ammonia oxidizing archaea (AOA). Soil DNA was extracted and the *amoA* gene, which encodes the ammonia monooxygenase enzyme, was quantified using primers and probes coupled with real-time PCR analysis. Large undisturbed soil monolith lysimeters (0.5 m diameter and 0.7 m deep) were also collected and used to determine NO_3^- leaching and N_2O emissions (Cameron et al., 1992; Di et al., 2009b; 2009c). A standard closed chamber method was used to determine N_2O emissions from the treated lysimeters (Di et al., 2009c). The lysimeters were exposed to the same climatic conditions as the soil and pasture in the surrounding field. Pasture was harvested at typical grazing heights and intervals to determine pasture yield. Pasture responses have also been measured on commercial dairy farms under realistic grazing conditions (Moir et al., 2007).

3. Results & Discussion

The AOB population abundance and activity grew rapidly following the application of animal urine at $1000 \text{ kg N ha}^{-1}$, with the *amoA* copy numbers increasing by 3.2-10.4 fold the different soils (Di et al., 2009a). However, when the nitrification inhibitor, DCD, was applied, the AOB population growth was significantly inhibited. In contrast, the AOA population abundance and activity did not change with the supply of the large dose of urine-N substrate. The addition of the urine-N substrate significantly increased the nitrification rate, as indicated by the rising NO_3^- -concentrations, but the nitrification rates were reduced by the DCD treatments. DCD did not adversely affect other soil microbial populations, such as methanotrophs (Di et al., 2011).

Fourteen datasets on NO_3^- leaching from a range of soil and environmental conditions published in internationally peer reviewed journals show that the DCD nitrification inhibitor technology reduced NO_3^- leaching from urine patch areas by an average of 64%, with a standard error of $\pm 3.6\%$ (Cameron et al., 2009). The small standard error of 3.6% indicates that there is a high level of

consistency in the effectiveness of this technology in reducing NO_3^- leaching losses. Similarly, de Klein et al. (2011) reported that twenty three datasets of N_2O emissions from a range of soil and environmental conditions across New Zealand published in international peer reviewed journals showed that the nitrification inhibitor technology reduced N_2O emissions from urine patch areas by an average of 57%, again showing the high efficacy in reducing N_2O . Pasture yield increases up to 20% have also been recorded when DCD is applied (Moir et al., 2007).

Acknowledgments

We thank the New Zealand Ministry of Science and Innovation (MSI), Ravensdown Ltd, Ministry of Agriculture and Forestry (MAF), the Pastoral 21 Consortium, and the Pastoral Greenhouse Gas Research Consortium for funding.

References

- Cameron, K.C., Smith, N.P. McLay, C.D.A., Fraser, P.M., McPherson, R.J., Harrison, D.F. and Harbottle P. 1992. Lysimeters without edge-flow: an improved design and sampling procedure. *Soil Sci Soc Am J* 56, 1625-1628.
- Cameron, K.C., Di, H.J. and Moir, J.L. 2009. The effectiveness of nitrification inhibitor technology to improve the sustainability of agriculture. *Primary Industry Management* 13, 19-23.
- De Klein C., Cameron, K.C., Di H.J., Rys G., Monaghan R. and Sherlock R.R. 2011. The effect of long-term use of the nitrification inhibitor DCD on reducing N_2O emissions from cow urine. *Animal Feed Science and Technology* 166-167, 480–491.
- Di, H.J. and Cameron K.C. 2002a. Nitrate leaching in temperate agroecosystems: sources, factors and mitigating strategies. *Nutr Cycl Agroecosys* 46, 237-256.
- Di, H.J. and Cameron K.C. 2002b. The use of a nitrification inhibitor, dicyandiamide (DCD), to reduce nitrate leaching and nitrous oxide emissions in a simulated grazed and irrigated grassland. *Soil Use Manage* 18, 395-403.
- Di, H.J. and Cameron K.C. 2003. Mitigation of nitrous oxide emissions in spray-irrigated grazed grassland by treating the soil with dicyandiamide, a nitrification inhibitor, *Soil Use Manage* 19, 184-290.
- Di, H.J. and Cameron, K.C. 2004. Treating grazed pasture soil with a nitrification inhibitor, eco-nTM, to decrease nitrate leaching in a deep sandy soil under spray irrigation. *N Z J Agric Res* 47, 351-361.
- Di, H.J. and Cameron K.C. 2005. Reducing environmental impacts of agriculture by using a fine particle suspension nitrification inhibitor to decrease nitrate leaching from grazed pastures. *Agric, Ecosyst Environ* 109, 202-212.
- Di, H.J. and Cameron, K.C. 2006. Nitrous oxide emissions from two dairy pasture soils as affected by different rates of a fine particle suspension nitrification inhibitor, dicyandiamide (DCD). *Biology and Fertility of Soils* 42: 472-480.
- Di, H.J. and Cameron, K.C. 2007. Nitrate leaching losses and pasture yields as affected by different rates of animal urine nitrogen returns and application of a nitrification inhibitor – a lysimeter study. *Nutr Cycl Agroecosys* 79, 281-290.
- Di, H.J., Cameron, K.C. and Sherlock, R.R. 2007. Comparison of the effectiveness of a nitrification inhibitor, dicyandiamide (DCD), in reducing nitrous oxide emissions in four different soils under different climatic and management conditions. *Soil Use Manage* 23, 1-9.
- Di H.J., Cameron, K.C., Shen, J.P., He J.Z. and Winefield C.S. 2009b. Nitrate leaching from grazed grassland as affected by a nitrification inhibitor, dicyandiamide, and relationships with ammonia oxidizing bacteria and archaea. *Soil Use Manage* 25, 454-461.
- Di, H.J., Cameron, K.C., Shen J.P., Winefield C.S., O'Callaghan M., Bowatte S. and He, J.Z. 2010a. Ammonia oxidizing bacteria and archaea grow under contrasting soil nitrogen conditions. *FEMS Microbiology Ecology* 72, 386-394.
- Di, H.J., Cameron, K.C., Shen, J.P., Winefield C.S., O'Callaghan M., Bowatte S. and He, J.Z. 2009a. Nitrification driven by bacteria and not archaea in nitrogen rich grassland soils. *Nature Geoscience* 2, 621-624.
- Di H.J., Cameron, K.C., Sherlock, R.R., Shen J.P., He J.Z. and Winefield C.S. 2010b Nitrous oxide emissions from grazed grassland as affected by a nitrification inhibitor, dicyandiamide, and relationships with ammonia oxidizing bacteria and archaea. *J Soils Sediments* 10, 943-954.
- Di, H.J., Cameron, K.C., Shen, J.P., Winefield C.S., O'Callaghan M., Bowatte S. and He, J.Z. 2011. Methanotroph abundance not affected by applications of animal urine and a nitrification inhibitor, dicyandiamide, in six grazed grassland soils. *J Soils Sediments*. 11, 432-439.
- Moir, J., Cameron, K.C. and Di, H.J. 2007. Effects of the nitrification inhibitor dicyandiamide on soil mineral N, pasture yield, nutrient uptake and pasture quality in a grazed pasture system. *Soil Use Manage* 23, 111-120.

Agricultural measures has reduced the nitrogen surplus by almost 50% in Denmark

Vinther, F.P., Børgesen, C.D.

Dept. of Agroecology, Aarhus University, Denmark

1. Background & Objectives

For nutrients, where a loss can have an adverse impact on the environment, the surplus is a good indicator of the development in the potential environmental impact of agriculture seen over a number of years. The nutrient surplus corresponds to the total quantity of excess nutrients on the farm when the amount of nutrients exported via sales of plant and animal products have been deducted from the amount in imported feedstuffs and inorganic fertilizers or in other ways has been added at farm level. The surplus thus consists of what can be lost via ammonia volatilisation from housing and stores or during field application, denitrification, leaching or surface runoff, or through changes in the soil pool. One of the tools used in Denmark to follow how the situation develops and to evaluate environmental action plans has been the annual estimates of nitrogen (N) and phosphorus (P) surplus from the agricultural sector (Vinther and Olsen, 2011). The purpose with this paper is to describe how the N surplus has developed in Denmark during the last 25 years and to pinpoint measures that have been most effective in reducing the surplus.

2. Materials & Methods

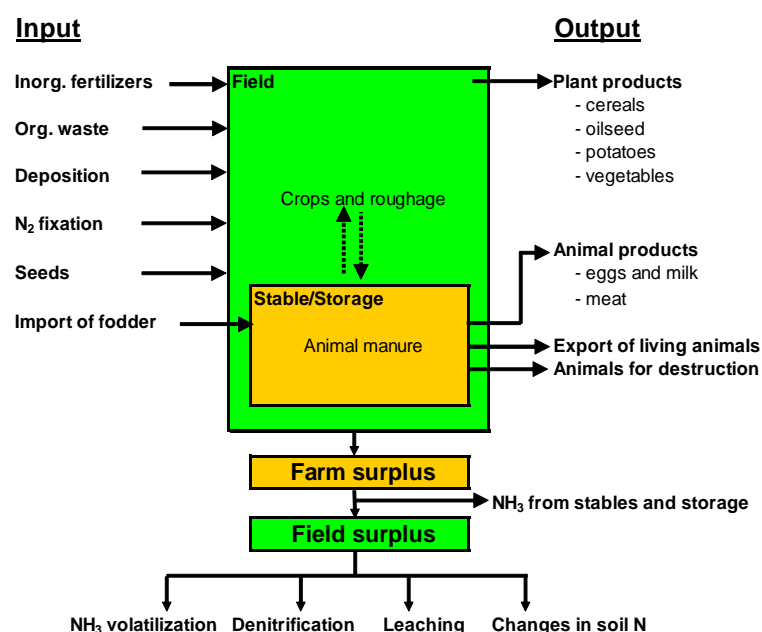

Figure 1. Schematic diagram showing the principles for calculating the N balance for the agricultural sector. The principles for the P balance are similar, except that N₂ fixation and NH₃ emission is omitted.

The nitrogen surplus is estimated from a kind of farm gate balance, where the entire Danish agricultural sector is considered to be 'one farm'. Data primarily from Statistics Denmark are used combined with values of N contents of individual products (Kyllingbæk, 2005). By using the principles of a farm gate balance estimates of the internal turnover between fodder crops and animal manure, which only can be estimated with high uncertainty, are not needed (Figure 1). However, the average field surplus can be indirectly estimated from the farm surplus by subtracting NH₃ losses from stables and storages. The field N surplus can be lost either via NH₃ volatilization, denitrification (N₂ and N₂O) or nitrate leaching or can contribute to the pool of organic N in the soil.

3. Results & Discussion

In many countries the environmental regulation is to a great extent based on volunteer and subsidized measures to reduce nutrient loads to the aquatic environment, whereas in Denmark, basically all environmental regulation concerning handling and application of manure and fertilizers is based on legislation that can be controlled by the authorities either during control visits at the farm or via the mandatory fertilizer accounts. The legislation include maximum N-quotas at farm level, maximum amount of total N applied as animal manure, minimum utilization of N (plant available N) in animal manures, restrictions on spreading time and minimum storage capacity of animal manure, ban on tillage in autumn and on ploughing of grass fields in autumn, obligatory fertilizer plans and fertilizer accounts for all farms, and minimum acreage with catch crops.

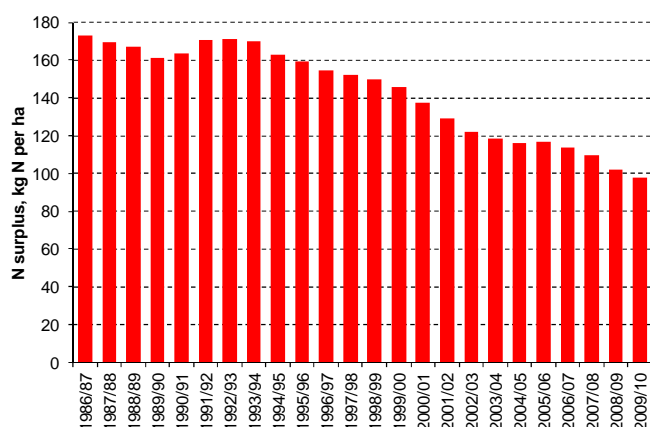

Figure 2. The development in N surplus (kg N ha⁻¹) in Denmark in the period 1986- 2010. From Vinther and Olsen (2011).

All these legal rules about use and handling of manure and fertilisers were implemented along with the several environmental actions plans that have been running since 1985 have resulted in significant reductions in the nutrient surplus. The N surplus has been reduced from 173 kg N ha⁻¹ in 1986/87 to 98 kg N ha⁻¹ in 2009/10, corresponding to a 40% reduction (Figure 2).

4. Conclusion

The nitrogen surplus in the agricultural sector has been reduced significantly during the last 25 years, and the most important measures has been

- the introduction of maximum N-quotas at farm level, i.e., maximum amount per acreage of total N applied as animal manure and mineral fertiliser
- the tightening of the legal minimum utilization of N (plant available N) in animal manures, which for pig slurry has been increased from about 20% to 75% over the years. If for example a crop needs 140 kg N ha⁻¹ and 100 kg total N ha⁻¹ is added as pig slurry, of which 75 kg N ha⁻¹ is considered to be plant available, then only 65 kg N ha⁻¹ is allowed as mineral fertiliser

References

- Kyllingsbæk, A. 2005. Nutrient balances and nutrient surpluses in Danish agriculture 1979-2002. Danish Institute of Agricultural Sciences, Foulum. DJF Report no. 116 pp. 103 (In Danish).
- Vinther, F. P. and Børgesen, C.D. 2010. Nutrient surplus as a tool for evaluating environmental action plans in Denmark. OECD Workshop on Agri-Environmental Indicators, Leysin, Switzerland, 23-26 March, 2010, pp. 8.
- Vinther, F. P. and Olsen, P. 2011. Nutrient balances and nutrient surpluses in Danish agriculture 1989-2009 (2010). Department of Agroecology, Aarhus University. Internal report no. 102 pp. 22 (in Danish).

Ammonia emission after on-farm application of additives in pig slurry lagoons

Viguria, M.^a, Arriaga, H.^a, Merino, P.^a

^aNEIKER-Tecnalia, Basque Institute for Agricultural Research and Development, Derio, Spain

1. Background & Objectives

Ammonia (NH₃) has achieved importance in animal production from the point of view of environmental and health protection. Around 75% of European NH₃ emission comes from livestock production (Webb et al., 2005). In pig farms, approximately 50% of the NH₃ emission is from pig housing and slurry storage (van der Peet-Schwering et al., 1999). Slurry additives could reduce NH₃ volatilization from manure storage, as they are used to influence certain properties (stimulate or inhibit microbial conversion processes), but few on-farm studies have been carried out to support their benefits. The urease inhibitor N-(*n*-butyl) thiophosphoric triamide (NBPT) was evaluated in a laboratory experiment when applied to pig slurry, but contradictory results were obtained (Panetta et al., 2004). In this study, an on-farm experiment was performed in order to estimate the effects of Agrotain[®] (NBPT commercial product) and Gel Biopolym[®] (aromatic plants and bacterial-enzyme complex, used by farmers in the Basque Country, Spain) additives on NH₃ emissions from pig slurry storage.

2. Materials & Methods

Agrotain[®] (AG) and Gel Biopolym[®] (GB) were simultaneously tested in 2 slurry lagoons (768 m³ and 1000 m³) placed in a fattening pig farm, from 11th of May to 2nd of June. AG was split in two doses, which were calculated based on Dell and Brandt (2011): 29 mg AG kg⁻¹ slurry at the beginning (period 1, from day 1 to day 6) and 57 mg AG kg⁻¹ slurry (period 2, from day 7 to day 17). GB was applied at 0.02 ml kg⁻¹ once, following suppliers recommendations. A control treatment (CT) without additive was established (3 m³ slurry). NH₃ emission from lagoons was measured using a dynamic chamber system similar to that described by Peu et al. (1999). Samples were determined *in situ* by a Bruel & Kjaer 1302 photoacoustic analyzer during 5 hours each day, with a frequency of 3-4 days a week. Two slurry replicates were analysed from each lagoon for dry matter (DM), organic matter (OM), total N (TN), ammonium-N (NH₄⁺-N) and C_{org}/N_{total} ratio.

3. Results & Discussion

Slurry chemical characterization from CT, GB and AG lagoons before additive application was presented on Table 1.

Table 1. Slurry characterization from CT, GB and AG lagoons before additive application.

Parameters	CT	GB	AG
DM (%)	3.17	2.40	5.08
OM (%)	62.73	58.6 ⁴	64.87
TN (g L ⁻¹)	3.96	3.65	6.15
NH ₄ ⁺ -N (g L ⁻¹)	3.14	3.11	4.78
C _{org} /N _{total}	2.97	2.27	3.19

During two days before additive application, NH₃ emission averaged 25.20 ± 2.31 mg NH₃ m⁻² h⁻¹ in the three treatments. After the first application of additives and during the following three days, NH₃ volatilization was similar for GB and AG, with 0.08% of TN, while for CT was 0.14%. Under optimal climatic conditions for NH₃ volatilization (warm temperature and no rainfall), a decrease in NH₃ emission was observed from GB treatment after the first three days (Figure 1). In period 2, with a second AG application, NH₃ loss represented 0.05%, 0.06% and 0.09% of TN from GB, AG

and CT, respectively. At this time, rainfall from day 5 to day 14 could have also influenced the reduction on NH_3 emissions from lagoons in all treatments.

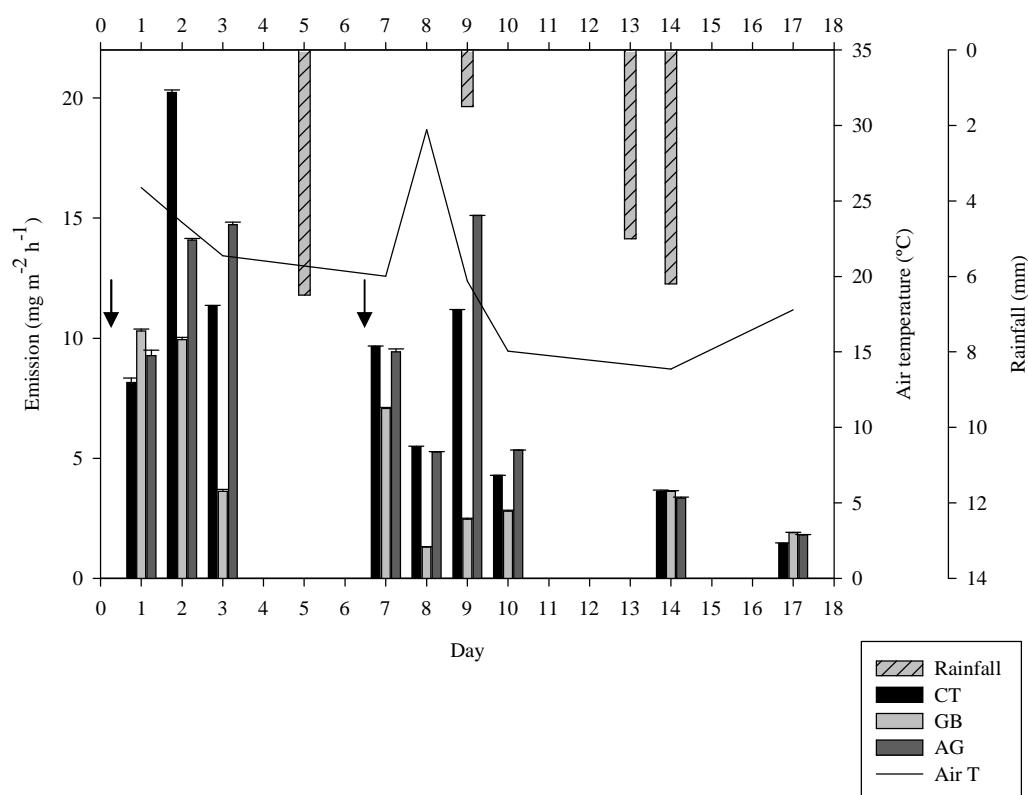

Figure 1. Pattern of daily NH_3 emission ($\text{mg m}^{-2} \text{h}^{-1}$) during 5 hours, air temperature ($^{\circ}\text{C}$) and rainfall (mm). Additives were applied on days pointed by arrows.

During 17 days, NH_3 volatilization was 0.15%, 0.16% and 0.25% from GB, AG and CT, respectively, related to TN content presented in slurries before additive application. The proportional deviation on NH_3 emission was -0.47 and -0.03 for GB and AG, respectively, considering a value equal to 1 for CT.

4. Conclusion

NH_3 volatilization from GB treatment was reduced by 47% with respect to CT until 17 days after additive application. GB additive could be considered a usable product for NH_3 abatement from slurry lagoons in actual farms. The effect of AG additive on NH_3 emission was not observed at the dose studied.

References

- Dell, C. and Brandt, R. 2011. Effect of AgrotainPlus application rates on ammonia emissions from liquid dairy manure. Technical report.
- Panetta, D.M., Powers, W.J. and Lorimor, J.C. 2004. Direct measurement of management strategy impacts on ammonia volatilization from swine manure. ASAE Paper No. 044107
- Peu, P., Beline, F. and Martinez, J. 1999. A floating chamber for estimating nitrous oxide emissions from farm scale treatment units for livestock wastes, *Journal of Agricultural Engineering Research* 73, 101-104.
- Van der Peet-Schwering, C.M.C., Aarnink, A.J.A., Rom, H.B. and Dourmad, J.Y. 1999. Ammonia emissions from pig houses in The Netherlands, Denmark and France. *Livestock Production Science* 58, 265-269.
- Webb, J., Menzi, H., Pain, B.F., Misselbrook, T.H., Dammgen, U., Hendriks, H. and Dohler, H. 2005. Managing ammonia emissions from livestock production in Europe, *Environmental Pollution* 135, 399-406.

Ammonia emissions from bovine slurries during storage

Rochford, N.M.^{a, b}, Lanigan, G.J.^a, Lalor, S.T.J.^a Byrne, K.A.^b

^a Crops, Environment and Land Use Programme, Teagasc, Johnstown Castle, Wexford, Rep. of Ireland.

^b Department of Life Sciences, University of Limerick, Limerick, Rep. of Ireland.

1. Background & Objectives

Agriculture is responsible for 98% of Ireland's total ammonia (NH₃) emissions, with land-spreading and housing/storage of manures contributing the majority of these emissions (Hyde et al., 2003). The Irish herd has approximately 6.3 million animals, with 37 million tonnes of manure being produced during the winter housing period. Of this, 29.3 million tonnes of manure is slurry (79.2 %), with the remaining 7.7 million tonnes being solid manure (20.8 %), (Lalor and Schulte, 2008). Important factors that determine the amount of NH₃ emitted from animal operations include: number, age and type of animals; housing design and management; type of manure storage and treatment; land application technique; and environmental conditions (Leneman *et al.*, 1998). Zhang et al. (2005) reported NH₃ emission rates from slurry in storage that were four times higher at temperatures of 13 °C compared with storage at 2°C. A dietary change with feed of a lower crude protein is considered to be an efficient way of reducing N loss from manure thus reducing NH₃ emissions (Külling et al., 2001; Oenema et al., 2007). Currently, national ammonia inventory calculations do not account for animal type, diet or climatic conditions. The objective of this experiment was to quantify the effect of animal type, diet and storage temperature on ammonia (NH₃) emissions from bovine slurry in storage.

2. Materials & Methods

Slurry collection

Manure was collected from bovine animals of four different age groups: two 7 year old dry dairy cows; two 7 year old beef cows; two 13 month old beef steers; and two 8 month old beef heifers. All the animals were fed each of the three different diets ad-lib over a two to three week period or until approximately 200 litres of slurry had been collected. Manure was collected daily and stored in sealed containers to minimise NH₃ losses. This was then divided up into 25 litre batches and frozen until incubation. The three diets were chosen to represent different C:N ratios of typical Irish livestock diets. Diet 1 was ad-lib grass silage. Diet 2 was 50 % grass silage and 50 % concentrates. Diet 3 was ad-lib concentrates and straw.

Slurry incubation

Slurries were incubated in 5 litre open cylinders at temperatures of 5, 10, 15, 20 °C and all at 80 % relative humidity. The experiment was conducted as a randomised block design with four replications. Ammonia emissions were measured on days 0, 5, 9, and 14 of incubation, using a static chamber coupled to an Innova 1412 Photoacoustic Field Gas Monitor (LumaSense Technologies, Inc.). Fluxes were calculated based on concentration accumulation within the chamber over a five minute period. The effects of diet, animal type and temperature and their interactions on cumulative emissions were analysed by Analysis of Variance using Proc Mixed in SAS.

3. Results & Discussion

Ammonia emissions were significantly affected by animal type (P<0.001), diet (P<0.001) and temperature (P=0.05). All two-way interactions were also significant (P<0.05). Manure from the

older animals fed diets 1 and 2 had the highest emissions (Figure 1a). Manure from animals fed diet 3 had the lowest emissions, with no significant variation between animal types. The emissions increased significantly with temperature only in the case of diet 1 (Figure 1b). Manure from the older animals had higher emissions compared to the younger animals across all temperatures (Figure 1c). There was no clear effect of temperature on emissions within animal type, except in the case of dairy cows at 15 °C, and 8 month old heifers at 20 °C where emissions were higher.

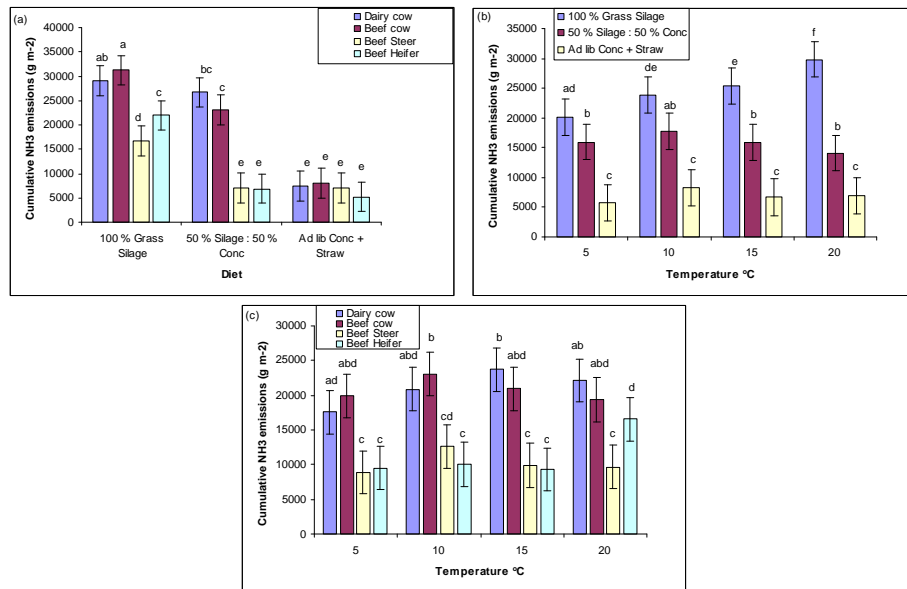

Figure 1. (a) Interactive effects of diet and animal type, temperature and diet (b), and temperature and animal type (c) on NH₃ emissions from bovine slurry in storage. (Letters indicate differences at P<0.05).

4. Conclusions

Animal type, diet and temperature had a significant effect on NH₃ emissions during manure storage, indicating potential benefits to including these factors in national NH₃ emission inventories. Further work is required to relate these emissions data to varying manure characteristics and farm-scale housing systems.

Acknowledgements

The authors greatly acknowledge funding from the Atlantic Area Programme 2007-2013, the European Regional Development Fund and the Teagasc Walsh Fellowship Fund.

References

- Hyde, B.P., Carton, O.T., O'Toole, P. and Misselbrook, T.H. 2003. A new inventory of ammonia emissions from Irish agriculture. *Atmospheric Environment* 37(1), 55-62.
- Külling, D.R., Menzi, H., T.F, K., Nefel, A., Sutter, F., Lischer, P. and Kreuzer, M. 2001. Emissions of ammonia, nitrous oxide and methane from different types of dairy manure during storage as affected by dietary protein content. *The Journal of Agricultural Science, Cambridge University Press* 137(2), 235-250
- Lalor, S.T.J. and Schulte, R.P.O. 2008. Low-ammonia-emission application methods can increase the opportunity for application of cattle slurry to grassland in spring in Ireland. *Grass and Forage Science* 63(4), 531-544.
- Leneman, H., Oudendag, D.A., Van der Hoek, K.W. and Janssen, P.H.M. 1998. Focus on emission factors: a sensitivity analysis of ammonia emission modelling in the Netherlands. *Environmental Pollution* 102, 205-210.
- Oenema, O., Oudendag, D. and Velthof, G.L. 2007. Nutrient losses from manure management in the European Union. *Livestock Science*, 112(3) 261-272.
- Zhang, G., Strom, J.S., Li, B., Rom, H.B., Morsing, S., Dahl, P. and Wang, C., 2005. Emission of ammonia and other contaminant gases from naturally ventilated dairy cattle buildings. *Biosystems Engineering* 92(3), 355-364.

Ammonia volatilization losses from urea treated with N-(n-butyl) thiophosphoric triamide (NBPT) stored at different temperatures

Soares, J.R.^a, Cantarella, H.^a

^a Soils and Environmental Research Center, Agronomic Institute of Campinas (IAC), Campinas, SP, Brazil

1. Background & Objectives

Nitrogen loss through NH₃ volatilization is a main concern when urea (UR) is surface-applied. Studies in Brazil report average losses of 30% of the applied N (Cantarella et al., 2008).

Many organic and inorganic compounds have been tested as urease inhibitors to reduce NH₃ volatilization but the best results have been obtained with urea analogues, particularly N-(n-butyl) thiophosphoric triamide (NBPT) (Trenkel, 2010). However, the stability of NBPT added to urea remains unclear; there is evidence that the inhibitor can degrade during storage and before fertilizer application (Watson et al., 2008), which could affect the ability of NBPT to reduce NH₃ volatilization. Therefore, the objective of this study was to evaluate the efficiency of NBPT-treated urea as a function of storage conditions.

2. Materials & Methods

Two experiments were conducted in volatilization chambers under controlled laboratory conditions with temperature maintained at 25±3° C. The chambers were filled with samples of a Typic Hapludox (or Red Latossol) soil, moistened to 60% of the water retention capacity. Key chemical and physical properties were pH (CaCl₂) 5.9; organic matter 24 g dm⁻³; clay 403 g kg⁻¹ and sand 503 g kg⁻¹. The fertilizer used was prilled urea (UR) coated with NBPT (1060 mg kg⁻¹), in the form of the commercial product AGROTAIN (200 g/kg active ingredient). Prior to the volatilization study urea with or without NBPT was placed in sealed plastic bags, simulating fertilizer bags, and was stored for 1 to 9 months, in laboratory incubators at 25°C or 35°C. The NH₃ volatilized from the chambers was trapped into boric acid solution, which was replaced daily, and was determined by potentiometric titration (Cantarella and Trivelin, 2001). Residual NBPT was determined according with Douglass & Hendrickson (1991) Data were subjected to analysis of variance and means compared by the Tukey test, $p \leq 0.10$.

3. Results & Discussion

In experiment 1, NH₃ losses from urea without inhibitor reached 36% of the total N applied whereas losses from UR+NBPT stored for just 1 day were only 15%. In the treatments with UR+NBPT stored at 25°C for 1 and 3 months and stored at 35°C for 1 month, the NH₃ losses did not differ from those of UR+NBPT stored for 1 day. On the other hand, the treatment with UR+NBPT stored for 3 months at 35°C had 27% of N losses which were higher ($p \leq 0.10$) than those of UR+NBPT stored for 1 day (Figure 1). In experiment 2, the NH₃ losses from urea and UR+NBPT freshly prepared (1 day) were similar to those of experiment 1 (Figure 1). In the treatments with UR+NBPT stored at 25°C for 6 and 9 months the NH₃ losses reached 23% and were higher than those of UR+NBPT stored for 1 day, but lower than those of UR without the urease inhibitor. However, the NH₃ losses in the treatments with UR+NBPT stored at 35°C for 6 and 9 months did not differ from those of UR without NBPT (Figure 1). Some degradation of NBPT took place during storage (Table 1), mainly in the treatments stored at 35°C for 3 months (exp. 1), and in all treatments with UR+NBPT stored in experiment 2, similarly to that reported by Watson et al. (2008). This probably explains the loss of efficiency of the NBPT in these treatments. But, despite the very low concentration of NBPT after a long storage time, some inhibitory effect remained, probably due to the residues of NBPT or the product of its decomposition.

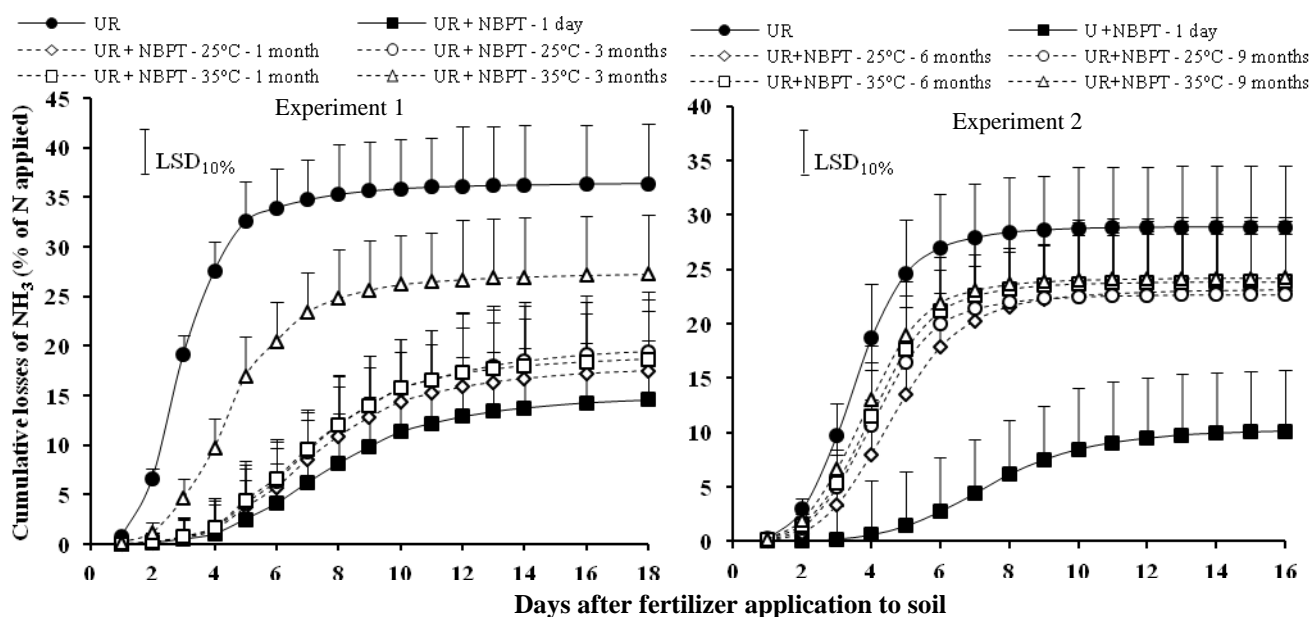

Figure 1. Cumulative losses of NH₃ after surface application of urea (UR) with or without the urease inhibitor (NBPT) stored at different temperatures and time periods. Data with overlapping vertical bars do not differ (Tukey, $p \leq 0.10$).

Table 1. Urease inhibitor (NBPT) content in urea with or without NBPT (1060 mg kg⁻¹) after different storage times and temperatures. Analysis undertaken up to 30 days after the end of the storage period.

Experiment 1	NBPT content mg kg ⁻¹	Experiment 2	NBPT content mg kg ⁻¹
UR	^a	UR	-
UR + NBPT - 1 day	890	UR + NBPT - 1 day	930
UR + NBPT - 25°C - 1 month	720	UR + NBPT - 25°C - 6 months	-
UR + NBPT - 25°C - 3 months	530	UR + NBPT - 25°C - 9 months	-
UR + NBPT - 35°C - 1 month	470	UR + NBPT - 35°C - 6 months	-
UR + NBPT - 35°C - 3 months	< 100	UR + NBPT - 35°C - 9 months	-

^a: below the limit of detection

4. Conclusion

NBPT applied to urea gradually lost its efficiency to reduce NH₃ volatilization with time and temperature of storage. However, even after 3 months of storage at 25°C or 1 month at 35°C, urea+NBPT reduced NH₃ losses by a similar amount to urea freshly treated with the inhibitor.

References

- Cantarella, H., Trivelin, P.C.O., Contin, T.L.M., Dias, F.L.F., Rossetto, R., Marcelino, R., Coimbra, R.B. and Quaggio J.A. 2008. Ammonia volatilisation from urease inhibitor-treated urea applied to sugarcane trash blankets. *Scientia Agricola* 65, 397-401.
- Cantarella, H. and Trivelin, P.C.O. 2001. Determination of inorganic N in soil by the steam-distillation method., In: Rajj, B. van; Andrade J.C., Cantarella H. and Quaggio J.A. (eds), *Chemical analysis for the evaluation of fertility of tropical soils*, Instituto Agronômico, Campinas pp. 271-276. (In Portuguese).
- Trenkel, M.E. 2010. Slow- and controlled-release and stabilized fertilizer: an option for enhancing nutrient efficiency in agriculture. International Fertilizer Industry Association, Paris, France.
- Watson, C.J., Akhonzada N.A., Hamilton J.T.G. and Matthews D.I. 2008. Rate and mode of application of the urease inhibitor N-(n-butyl) thiophosphoric triamide on ammonia volatilization from surface-applied urea. *Soil Use and Management* 24, 246-253.
- Douglass, E.A. and Hendrickson, L.L. 1991. HPLC method for the analysis of the urease inhibitor N-(normal-butyl) thiophosphoric triamide and its metabolites. *Journal of Agricultural and Food Chemistry* 39, 2318-2321.

Assessment of national scale groundwater nitrate monitoring data as a basis for evaluating mitigation measures

Tedd, K.^a, Coxon, C.^a, Daly, D.^b, Craig, M.^b and Misstear, B.^c

^aDepartment of Geology, Trinity College Dublin, Dublin 2, Ireland

^bEnvironmental Protection Agency, Richview, Dublin 14, Ireland

^cDepartment of Civil, Structural & Environmental Engineering, Trinity College Dublin, Dublin 2, Ireland

1. Background & Objectives

Eutrophication is the principal threat to surface water quality in Ireland. In some situations, groundwater represents a significant pathway for nutrient transport to surface water. Nitrate is usually the principal limiting nutrient responsible for eutrophication in estuarine and coastal waters (Neill, 2005). The interaction of agricultural management practices with soil type, climate, topography and hydrology gives rise to large variation in nutrient concentrations (Cherry et al., 2008). Variation in weather between years adds another layer of complexity and makes it difficult to distinguish the effect of the mitigation method from environmental noise (Lord et al., 2007). In response to the Nitrates Directive (91/676/EEC), Ireland has introduced and reviewed the Nitrates Action Programme via the European Communities (Good Agricultural Practice for Protection of Waters) Regulations 2010. These regulations provide for protection of waters against pollution from agricultural sources. The interim Water Framework Directive (2000/60/EC) (WFD) water quality status assessments were carried out by the Irish Environmental Protection Agency (EPA) in 2008. The assessments found that 41% of Irish estuarine and coastal water bodies (13% by area) are classified as having less than good status, as assessed using multiple biological elements. While very few Irish groundwater bodies (less than 1%) are classified as poor status due to the groundwater bodies failing to meet the drinking water objectives of the WFD, 16% of groundwater bodies are classified as 'at risk' owing to the potential deterioration of associated estuarine and coastal water quality by nitrate from groundwater (unpublished EPA data). This risk assessment takes into account the nitrate load from groundwater discharging to rivers reaching the estuarine and coastal water bodies, based on both the groundwater nitrate concentration and the proportion of river flow coming from groundwater (RPS, 2008). The majority of these 'at risk' groundwater bodies are in the southeast and southwest of Ireland where elevated nitrate concentrations may provide significant nutrient loading from groundwater to estuarine and coastal waters, either directly or via rivers. National scale groundwater nitrate data were assessed to evaluate factors affecting groundwater quality and status. In particular the relative influence of agricultural management and climate were investigated.

2. Materials & Methods

Groundwater nitrate data have been collected in Ireland since the 1970s. Typically, measurements in the 1970s and 1980s were conducted during the course of different projects implemented by the Geological Survey of Ireland or local authorities. In the 1990s, the EPA took responsibility for groundwater monitoring in Ireland and set up a new national monitoring network for groundwater quality and levels. In recent years, and particularly in response to the implementation of the WFD, the groundwater monitoring network in Ireland has been updated and expanded considerably. In the current study, analysis was made of groundwater nitrate data collected from 70 monitoring points within the South East River Basin District (SERBD). Nitrate data from monitoring points within different settings were investigated with respect to pressure layers (including land cover, fertiliser application rates, livestock and septic tank density) and pathway layers (including soils, unconsolidated deposits, bedrock geology and climate data).

3. Results & Discussion

The average nitrate concentration in the SERBD from 1990 to 2010 is approximately 20 mg NO₃ L⁻¹. A few monitoring points show low nitrate concentrations, suggestive of denitrifying conditions, and a few other monitoring points exceed the Drinking Water Directive's limit of 50 mg NO₃ L⁻¹ for nitrate. A considerable proportion of groundwater quality monitoring points show a large variation in nitrate concentrations in recent years (an example may be seen in Figure 1).

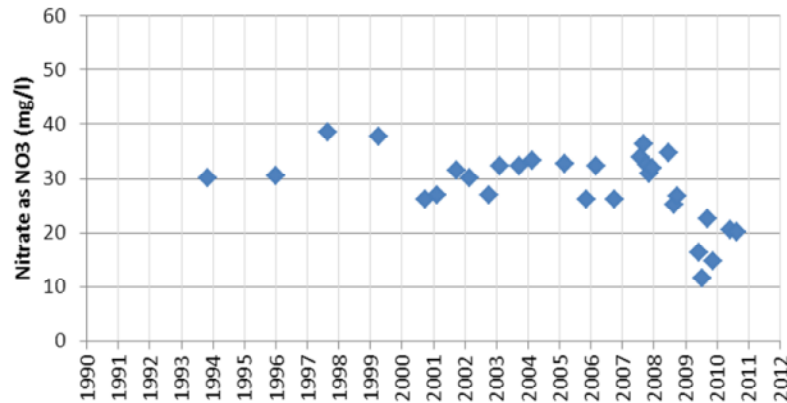

Figure 1. Variation in groundwater nitrate concentration in a monitoring point within the Dinantian Pure Bedded Limestones in Co Kilkenny

Groundwater nitrate concentrations are likely to have been affected by the above average rainfall in 2008 and 2009; 117% and 125% of the long term annual average was recorded at the Johnstown Castle synoptic station in 2008 and 2009 respectively (Met Eireann, 2009, 2010). They may also have been influenced by improved agricultural management as a result of the Good Agricultural Practice regulations, which first came into force in 2006.

4. Conclusion

In order to accurately assess the impacts of improved agricultural management practices, and to provide for good decision making in the future, it will be important to decouple the impacts of management practices and climate. Further work, utilising additional pathway and pressure data, together with a greater understanding of nitrate transport and attenuation processes, will be important. Good quality groundwater quality monitoring data will provide the basis for this process.

References

- Cherry, K.A., Shepard, M., Withers, P.J.A. and Mooney, S.J. 2008. Assessing the effectiveness of actions to mitigate nutrient loss from agriculture: a review of methods. *Science of the Total Environment* 406, 1-23
- European Communities (Good Agricultural Practice for Protection of Waters) Regulations 2010. Statutory Instruments No. 610 of 2010. The Stationery Office, Dublin.
- Lord, E., Shepherd, M., Silgram, M., Goodlass, G., Gooday, R., and Anthony, S.G. Investigating the effectiveness of NVZ Action Programme measures: development of a strategy for England. Report for DEFRA project WT03017; 2007. 108pp. Available at <http://www.defra.gov.uk/science/default.htm>.
- Met Eireann, 2009. The weather of 2008. Met Eireann, Dublin, Ireland.
- Met Eireann, 2010. The weather of 2009. Met Eireann, Dublin, Ireland.
- Neil, M. 2005. A method to determine which nutrient is limiting for plant growth in estuarine waters—at any salinity. *Marine Pollution Bulletin* 50 Pp. 945-955
- RPS, 2008. Further Characterisation Study. An integrated approach to quantifying groundwater and surface water contributions of stream flow. Unpublished report.

Bedding additives reduce ammonia emissions during storage and after application of cattle straw manure, and improve N utilization by grassland

Shah, G.A.^a, Rashid, M.I.^a, Groot, J.C.J.^a, Groot Koerkamp, P.W.G.^b, Lantinga, E.A.^a

^aOrganic Farming Systems Group, Wageningen University, Droevendaalsesteeg 1, building 107, 6708 PB Wageningen, the Netherlands; ^bFarm Technology Group, Wageningen University, Bornse Weiland 9, 6700 AA Wageningen, the Netherlands

1. Background & Objectives

Considerable amounts of nitrogen (N) are lost from each phase of the manure management chain (animal housing, manure storage and manure application) as ammonia (NH₃) through urea hydrolysis, dissociation and volatilization. However, the control of N losses during one phase could enhance them in subsequent phases (Rotz, 2004). Therefore, it is crucial to develop and evaluate effective measures that can reduce emissions throughout the whole manure management chain and enhance N utilization after land application. The objectives of this study were (i) to quantify the mitigating effects of three promising bedding additives, i.e. zeolite, lava meal and sandy farm topsoil on NH₃ emissions during storage and after land application of cattle straw manure, and (ii) to determine total apparent herbage N recovery (ANR) after surface spreading of these manures on grassland.

2. Materials & Methods

Three bedding additives were applied inside a naturally ventilated sloping-floor barn proportionally to the daily straw dosage of 5 kg per livestock unit, i.e. 10% of zeolite, 20% of lava meal or 33% of sandy farm topsoil. These proportions were selected after a preliminary trial where the effects of applying various proportions of each additive on NH₃ emission from the straw manure beddings were evaluated. The selection criterion for this was to achieve a remarkable reduction (~80%) compared to the control during the housing phase (results not presented). The trampled-down straw manures were collected daily from the barn for a period of 80 days. The manures were then stockpiled inside a roofed building as four separate heaps: untreated straw manure (control) and straw manure amended with zeolite, lava meal or farm topsoil. Manures were stored for 80 days after the cessation of the collection period. NH₃ emission rates from the heaps were determined by using a flux chamber connected to a photoacoustic gas monitor by two Teflon tubes. The total internal volume of the chamber was $2.12 \times 10^{-2} \text{ m}^3$. At each measurement event, the flux chamber was pressed down 4 to 5 cm deep into the surface of the manure heap. Thereafter, time patterns of NH₃ concentration was recorded for 10 to 15 minutes. Actual NH₃ emission rates were estimated from the initial slope of the curve between NH₃ (gas) concentration (mg m⁻³) and time (minutes). The measurements were done at two random places on the surface of each manure heap thrice after the end of the collection period. These were stopped when NH₃ concentration was reached below the detection limit of the measuring equipment due to the formation of dry crust on the heap surface. After storage, the manures were surface-spread manually on cut grassland in circular plots each with a diameter of 3 m at an application rate of 400 kg N ha⁻¹ according to a randomized complete block design with three replicates. NH₃ concentration in the air above each plot was measured immediately after manure spreading by means of three diffusion samplers installed 20 cm above the soil surface in the middle of each plot for 72 hours. The distance between the two adjacent plots was kept at 15 m to avoid NH₃ mixing among the treatments. It was assumed that NH₃ emission was proportional to the measured average NH₃ concentration in the air above each plot. Total dry matter

(DM) yield over three cuts and ANR from the treatments during the total growth period of five months were determined.

3. Results & Discussion

Chemical composition of the applied manures is presented in Table 1.

Table 1. Chemical composition of the applied straw manures.

Treatments	DM (%)	C _{total}	N _{total} (g kg ⁻¹ DM)	N _{min}	N _{org}	N _{min} /N _{total} (%)	C/N _{org} ratio	pH-CaCl ₂
Control	19.7	417	27.5	1.7	25.8	6	16	8.1
Zeolite	19.6	367	30.0	2.8	27.2	9	14	8.6
Sandy farm topsoil	21.7	304	25.9	2.6	23.3	10	13	8.6
Lava meal	20.5	347	24.9	1.7	23.2	7	15	8.3

Use of the bedding additives significantly ($P < 0.05$) reduced average NH₃ emission during storage and after application on grassland compared to the control (Table 2). This could be attributed to the adsorption of ammonium (NH₄⁺) by all of the additives and possible formation of struvite salt (ammonium magnesium phosphate hexahydrate; NH₄MgPO₄·6H₂O) by the lava meal.

Table 2. Means of NH₃ emission rates during the 80 days of storage period and during 3 days after application on grassland.

Treatments	During storage		After application	
	NH ₃ emission (mg m ⁻² day ⁻¹)	Reduction (%)	NH ₃ emission (µg m ⁻³)	Reduction (%)
Control	264 ^a ± 26 [†] *		117.5 ^a ± 23.8	
Zeolite	67 ^b ± 18	75	30.1 ^b ± 8.4	74
Sandy farm topsoil	87 ^b ± 20	67	29.4 ^b ± 9.8	75
Lava meal	58 ^b ± 16	78	50.9 ^b ± 10.8	57

*The means in the same column with different letters as superscript differ significantly ($P < 0.05$); [†]Means ± SEs

The application of each additive resulted in higher ($P < 0.05$) herbage N uptake, ANR and DM yield compared to the control (Table 3). This might be ascribed to reduction of NH₃ and other gaseous N emissions as well as prevention of nitrification, and subsequently nitrate leaching through NH₄⁺ adsorption by the additives after field applications of the manures.

Table 3. Total herbage dry matter (DM) yield, N uptake and apparent N recovery (ANR) over 3 cuts.

Treatment	Total of 3 cuts		
	DM yield (Mg ha ⁻¹)	N uptake (kg ha ⁻¹)	ANR (%)
Zero	2.2 a*	43.1 a	
Control [‡]	3.6 b	87.6 b	11 a
Zeolite	5.1 c	148.2 c	26 b
Sandy farm topsoil	4.9 c	141.7 c	25 b
Lava Meal	5.3 c	153.8 c	28 b

*The means in the same column with different letters differ significantly ($P < 0.05$); [‡]Untreated manure

4. Conclusions

Use of the bedding additives not only reduced NH₃ emissions during storage and after application of the manures, but also increased N utilization from the manures applied to grassland. It is worth noting that the sandy farm topsoil as a no cost resource was equally effective as the two rather expensive volcanic-based additives to reduce NH₃ emissions and to increase total apparent herbage N recovery.

Reference

Rotz C.A. 2004. Management to reduce nitrogen losses in animal production. Journal of Animal Science 82, E119-E137.

Can leguminous crops reduce nitrous oxide emissions?

Pappa, A.V.^a, Thorman, R.^b, Benette, G.^c, Rees, R.M.^a, Sylvester-Bradley, R.^b

^aSAC, West Mains Road, Edinburgh, EH9 3JG, United Kingdom

^bADAS Boxworth, Cambridge, CB23 4NN, United Kingdom

^cADAS UK Ltd., Gleadthorpe, Meden Vale, Mansfield, Nottingham, NG20 9PF, United Kingdom

1. Background & Objectives

There is an urgent global challenge in providing sufficient primary production to sustain a growing population, with increasing demands for foods, feeds and fuels, without exacerbating climate change and other environmental impacts of agriculture (Godfray et al., 2010). Biologically-fixed N from legumes may offer an opportunity to maintain crop production whilst reducing greenhouse gas (GHG) emissions from agricultural systems, partly due to the avoidance of emissions associated with fertiliser manufacture, and partly due to lower field emissions (Rochette and Janzen, 2005). The objective of this study is to compare the nitrous oxide (N₂O) emissions from arable leguminous crops with winter wheat under contrasting climatic conditions.

2. Materials & Methods

Experiments in Nottinghamshire, England (loamy sand) and East Lothian, Scotland (sandy loam) tested winter beans, spring beans, combining peas, vining peas and winter wheat in three replicate plots (12 m x 12 m) per treatment, in a completely randomised design (Table 1). N₂O flux measurements were made from the first sowing of each crop to harvest and measurements were made of crop yield, crop N uptake, direct N₂O emissions at 60 min (five static chambers per plot (40 cm x 40 cm)) and also random N₂O measurements at 0, 15, 30, 45 and 60 min of 5 chambers per sampling, soil moisture, nitrate and ammonium N, and temperature. After harvest, plots were divided (half with residues and half without residues) and intensive sampling followed for four weeks. Measurements will continue until November 2012 biweekly.

Table 1: Sowing dates for the four pulses and winter wheat for the two sites.

	Gleadthorpe	Edinburgh
Winter beans	28/10/2010	30/09/2010
Spring beans	08/03/2011	07/03/2011
Peas, combinable	08/03/2011	07/03/2011
Peas, vining	08/03/2011	07/03/2011
Winter wheat nil N	21/09/2010	28/09/2010

3. Results & Discussion

By the end of July 2011 the cumulative N₂O fluxes from the Scottish site were higher than those from the English site. Emissions for winter wheat with no N applied were significantly higher than emissions from the legumes at both sites (P<0.05) from sowing to end of July. If the cumulative values were presented from the sowing of the spring crops to the end of July, the cumulative emission from the winter wheat would be significantly (P<0.05) less than from the pulses at Gleadthorpe, but not significantly different at Edinburgh (data not shown). Emissions from legume crops were not significantly different at either site (Figure 1).

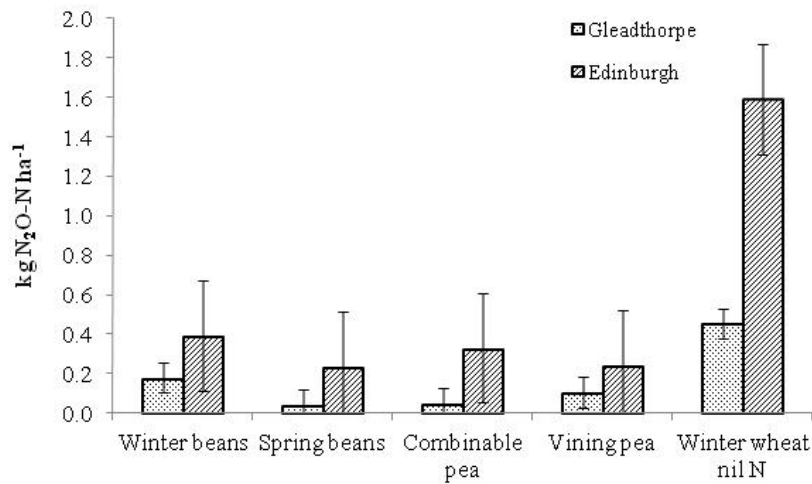

Figure 1. Cumulative N₂O emissions for four pulses and winter wheat at two sites in the UK (Nottinghamshire, Gleadthorpe and East Lothian, Edinburgh) from the day of sowing to end of July 2011.

4. Conclusions

Emissions were generally low throughout the growing season for all crops at both sites. Emissions data are not yet available after harvest but there are indications that residue removal increased emissions from vining peas. It will be important to collate data over 12 months for all crops (available in June 2012), in order to relate contributions of emissions during the growing season to those resulting after harvest and from residue incorporation and make stronger conclusions.

Acknowledgements

We acknowledge the UK's Defra and Scottish Government in sponsoring Sustainable Arable LINK Project LK09128, and the contributions of ADAS, Agricultural Industries Confederation, Bayer CropScience, British Sugar, Country Land and Business Association, The Co-operative, Frontier, GrowHow, AHDB-HGCA, Hill Court Farm Research, NFU, North Energy Associates, North Wyke Research, PGRO, REA, SAC, Scotch Whisky Research Institute, Soil Essentials, Vivergo fuels, Warburtons and Yara.

References

- Godfray, H C J, Beddington, J R, Crute, I R, Haddad, L, Lawrence, D, Muir, J F, Pretty, J, Robinson, S, Thomas, S M. and Toulmin C. 2010. Food Security: The Challenge of Feeding 9 Billion People. *Science* 327, 812-818.
- Rochette, P. and Janzen, H H. 2005. Towards a revised coefficient for estimating N₂O emissions from legumes. *Nutrient Cycling in Agroecosystems* 73, 171-179.

Characterization of indigenous rhizobial strains isolated from faba bean (*Vicia faba* L.) nodules

Blažinkov, M.^a, Redžepović, S.^a, Stipetić, A.^a, Toth, N.^b, Sikora, S.^a

^a University of Zagreb Faculty of Agriculture, Department of Microbiology, Zagreb, Croatia

^b University of Zagreb Faculty of Agriculture, Department of Vegetable Crops

1. Background & Objectives

Faba bean is a legume valuable as a significant source of protein rich food and it is used both as a human food and feed for livestock in the Mediterranean region, Middle East, China and Asia. The faba bean contributes to the sustainability of cropping systems via the ability to use atmospheric nitrogen in a symbiotic relationship with nitrogen fixing bacteria *Rhizobium leguminosarum* bv. *viciae*, reducing fossil energy consumption and application of mineral nitrogen fertilizers and providing source of nitrogen for future crop (Jensen et al., 2010). The high variations in the amount of fixed nitrogen are a result of genotypic characteristics and symbiotic efficiency of *R. leguminosarum* bv. *viciae* strains. The diversity of *R. leguminosarum* bv. *viciae* population has usually been determined by phenotypic and/or genotypic characterisation of strains isolated from legume root nodules (Martinez-Romero, 1994). The main objective of this study was to characterize indigenous *R. leguminosarum* bv. *viciae* strains isolated from faba bean nodules and to determine the genetic and phenotypic diversity in natural populations of faba bean rhizobia.

2. Materials & Methods

Nodules were collected from faba bean plants grown in the Mediterranean region of Croatia. Isolation of strains from surface sterilized nodules was performed following a standard protocol (Vincent, 1970). Twenty one field isolates were obtained from two locations in southern Dalmatia. Two *Rh. leguminosarum* bv. *viciae* strains were also included in these investigations as reference (1001) and type (30132) strains. In order to perform phenotypic characterization of indigenous strains, growth characteristics under different temperature conditions, pH values, salt concentration and carbon source assimilation were determined. PCR amplification of the *nodC* gene region was used for identification at the species and biovarieties level while RAPD and REP – PCR were used for identification at the strain level.

3. Results & Discussion

The existence of indigenous populations of faba bean rhizobia in the area of investigation was determined. The results of phenotypic characterization revealed that, apart from mannitol, all rhizobial strains can utilise a sucrose and lactose as carbon source. Under strong acidic (pH 4.5) and alkaline (pH 9.5) conditions, none of the strains isolated from the location Korčula could not grow. Strains from the Metković region were more tolerant to acidic conditions and their growth was determined at pH 4.5 and pH 5.0. All indigenous strains could not grow on medium containing more than 0.5% (w/v) NaCl, except strain M7 which could grow in medium containing 1% (w/v) NaCl. All strains tested grew extremely poorly or failed to grow at 37° C and above. After PCR amplification of the *nodC* gene region, the specific 220 bp product was determined in all strains indicating that indigenous strains belong to the species *R. leguminosarum* bv. *viciae*. Analysis of genetic variability among indigenous strains (Figure 1) revealed significant differences between reference strains and all field isolates. Among *R. leguminosarum* bv. *viciae* isolates considerable genetic diversity was also determined. Both RAPD and REP-PCR methods grouped all isolates from location Korčula in one cluster with

the exception of strain M6 which was grouped with isolates originating from the other location.

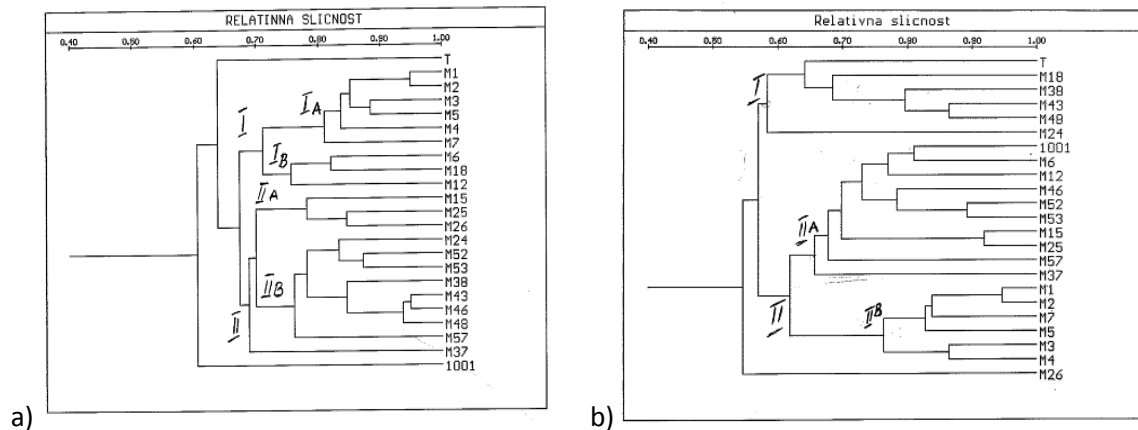

Figure 1. Dendrogram of *R. leguminosarum* bv. *viciae* strains derived from a) RAPD fingerprints generated using three different primers and b) REP-PCR fingerprints generated using REP- primers

4. Conclusion

The results of the present study revealed considerable genetic diversity among natural rhizobial populations. Further investigations are needed in order to obtain information about symbiotic properties of indigenous faba bean strains.

References

- Jensen E. S., Peoples M. B. and Hauggaard – Nielsen H. 2010. Faba bean in cropping systems. *Field Crop Research* 115,203-216.
- Köpke, U. and Nemecek, T. 2010. Ecological services of faba bean. *Field Crops Research* 115, 217-233.
- Martinez-Romero, E. 1994. Recent developments in *Rhizobium* taxonomy. *Plant and Soil*, 161, 11-20.
- Moschetti G., Peluso A., Protopapa A., Anastasio M., Pepe O. and Defez R. 2005. Use of nodulation pattern, stress tolerance, *nodC* gene amplification, RAPD – PCR and RFLP – 16S rDNA analysis to discriminate genotypes of *Rhizobium leguminosarum* biovar *viciae*. *Systematic and Applied Microbiology* 28, 619-631.
- Vincent, J.M. 1970. A manual for practical study of root – nodule bacteria. *International Biological Programme Handbook No. 15*, London

Comparison between grass, leguminous and crucifer species used as cover crops

Ramírez-García, J.^a, Carrillo, J.M.^a, Ruiz M.^b, Quemada, M.^{a*}

^aETSI Agrónomos, Technical University of Madrid, Ciudad universitaria s/n, 28040 Madrid (Spain)

^bInstituto Nacional de Investigación y Tecnología Agraria y Alimentaria (INIA), Centro Nacional de Recursos Fitogenéticos, Autovía Aragón Km 36, Apdo. 1045, Alcalá De Henares 28800, Madrid (Spain).

1. Background & Objectives

Introducing cover crops in the inter-crop period can entail benefits such as an improvement in weed and erosion control, reduced nitrate leaching, and higher soil nutrient content (Thorup-Kristensen et al., 2003). These crops are used in humid regions with high autumn precipitation, but could have a role in Mediterranean climate if irrigation is available to ensure establishment. Cover crops should use water efficiently, present rapid ground cover and high biomass production. Quality of the cover crop biomass determines both stubble decomposition and nutritional quality as fodder (Quemada and Cabrera, 1995). The objective of this work was to compare the suitability of different species of grass, legume and crucifer to be used as cover crops in semi-arid Mediterranean climate.

2. Materials & Methods

A factorial experiment with three replications was conducted in the experimental farm of the Technical University of Madrid (Central Spain). Factors were cover crops sown in October 2010: barley (*Hordeum vulgare L. cv. Tardana*), triticale (*x Triticosecale Whim cv. Forricale*), rye (*Secale cereale L. cv. Petkus*), mustard (*Sinapis alba L.*) and vetch (*Vicia sativa L. cv. Aitana*). Plot size was 1.2 x 7 m². Ground cover (GC) was determined by digital image analysis, fraction intercepted of photosynthetic active radiation (FIPAR) by mean of a ceptometer, and aerial biomass by destructive sampling in 17 dates. End of March 2011 cover crops were killed; the C/N of aerial biomass was determined by combustion (Dumas Method) and the dietary fiber content by enzymatic digestion (Van Soest and Robertson, 1991).

3. Results & Discussion

Barley reached the highest GC and FIPAR values since early stages, while vetch the lowest (Figure 1). Mustard covered the soil as fast as grasses until January, but after low temperatures lost plant biomass and reduced GC (Figure 2). At the end of the experiment barley and rye covered around 95% of the ground, while mustard 80%. Vetch cultivar selected especially for its resistance to low temperatures reached a 91% of GC. Rye and triticale produced the highest amount of biomass (1800-2100 g m⁻²), closely followed by the barley, while vetch lowest (750 g m⁻²). The C/N of the biomass presented a large variation, ranging from 13 for mustard to 35 for barley (Figure 3). Dietary fiber results revealed the grasses to be the most suitable to use as fodder, based on the high neutro-detergent fiber content and the low lignin (Figure 4). In figures, different letters indicate significant differences at the 0.05 level (Tukey).

4. Conclusions

Large differences in the measured variables were observed between cover crops. Grasses and mustard covered the soil faster and provided larger FIPAR in early stages than vetch, but these variables decayed for mustard after temperatures decreased in January. At harvest, vetch reached a high GC with the lowest biomass production. Triticale generated the highest amounts of biomass, but C/N was above 33. Grasses were more suitable for covering the ground and the N content in their biomass was equal to the legume, showing a high capacity to recycle N in the system.

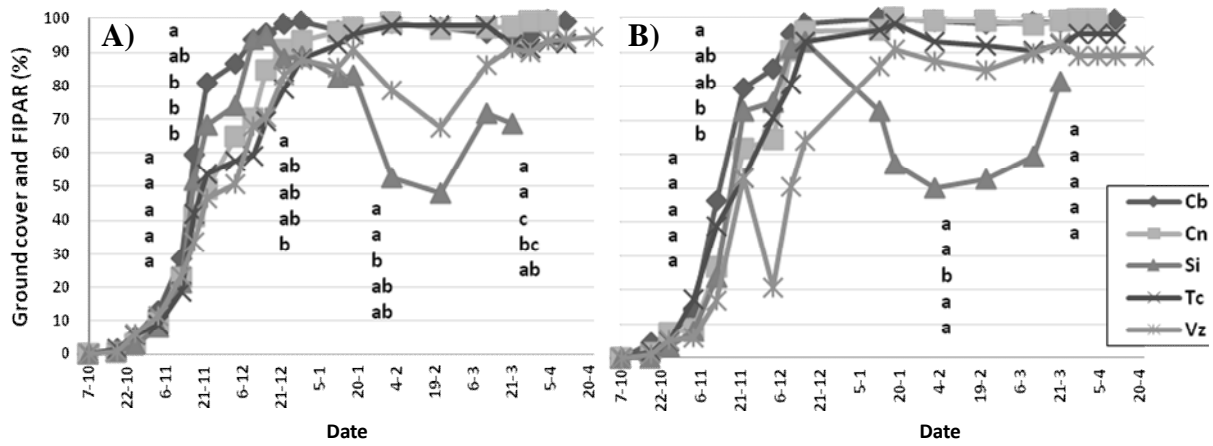

Figure 1. Ground cover (A) and FIPAR (B) evolution (%). Cb: Barley, Cn: Rye, Si: Mustard, Tc: Triticale, Vz: Vetch.

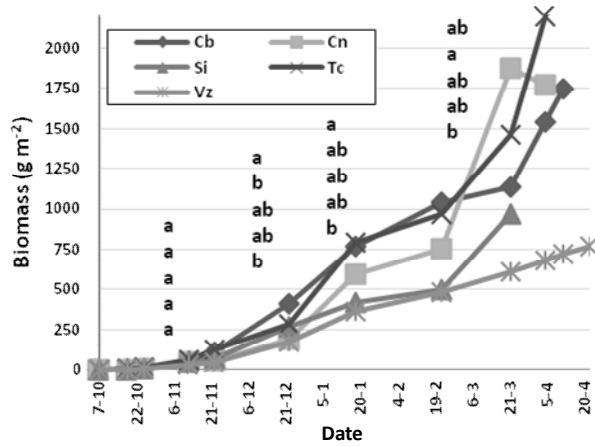

Figure 2. Biomass evolution (g m^{-2}). Cb: Barley, Cn: Rye, Si: Mustard, Tc: Triticale, Vz: Vetch.

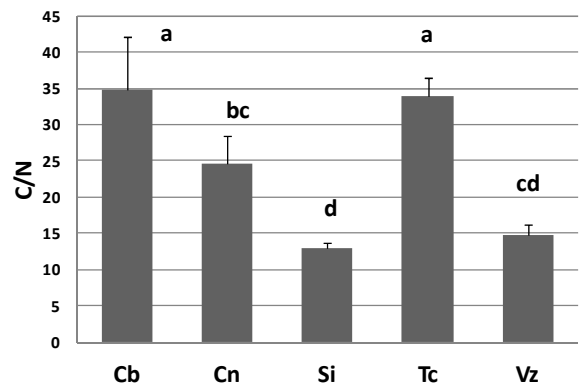

Figure 3. C/N relationship at the end of the experiment. Cb: Barley, Cn: Rye, Si: Mustard, Tc: Triticale, Vz: Vetch.

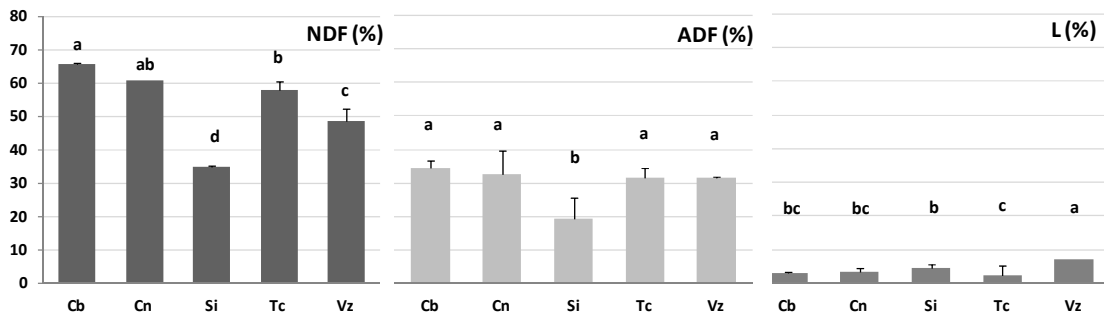

Figure 4. Dietary fiber content: Neutro-detergent fiber (FND%), acid-detergent fiber (ADF%) and lignin (L%) in biomass at the end of the experiment. Cb: Barley, Cn: Rye, Si: Mustard, Tc: Triticale, Vz: Vetch.

Acknowledgements: Financial support by CICYT (AGL2008-00163/AGR) and CAM (S2009/AGR1630).

References

Quemada, M. and Cabrera, M.L. 1995. Carbon and Nitrogen mineralization from leaves and stems of four cover crops. Soil Science Society of American Journal 59, 471-477.
 Thorup-Kristensen, K., Magid, J. and Jensen, L.S. 2003 Catch crops and green manures as biological tools in nitrogen management in temperate zones. Advances in Agronomy 79, 227-301.
 Van Soest, P.J., Robertson, J.B., Lewis, B.A., 1991. Methods for dietary fiber, neutral detergent fiber and non-starch polysaccharides in relation to animal nutrition. Journal of Dairy Science 74, 3583-3597.

Consequences of long-term application of alternative N sources on gaseous emissions.

Calleja-Cervantes, M.E.^a, Irigoien, N.^b, Cibriain, F.^c, Lasa, B.^a, Aparicio-Tejo, P.^a, Menendez, S.^a

^a Instituto de Agrobiotecnología. Public University of Navarre. Navarre. Spain

^b Departamento de Producción Agraria. Public University of Navarre. Navarre. Spain.

^c Navarre's Station of Viticulture and Oenology. Olite, Navarre. Spain.

1. Background & Objectives

Nowadays, alternative nitrogen sources are found in organic wastes that have been composted for their application as soil amendments. Overall, composted organic wastes are substances with desirable agricultural properties; its beneficial effects cover the total of soil functions. However, it is well documented that the increase in greenhouse gases (CO₂, CH₄ and N₂O) concentration in the atmosphere is one of the most detrimental repercussions on the environment due to fertilizer/amendment application. In the midst of understanding N fate with alternative N sources, this work explores if organic amendment application after 14 years has evident consequences on greenhouse gas emission.

2. Materials & Methods

To fulfil the abovementioned objectives, this research was carried out in a long-term experiment where a vineyard was established in 1996 in Bargaota, Navarre, Spain. The climate is a semi-Mediterranean, with hot summers and annual rainfalls between 450mm and 490mm. The mean annual temperature is 13.8°C. Soil texture in this area is loamy-clay. The experiment entailed the use of three composted fertilizers (amendments), one mineral and a control treatment which remained unfertilized. The fertilizers are described on Table 1 as follows, a pelletized organic compost of vegetable residues and cattle manure (PEL), a municipal solid waste compost (MSW), an organic compost made of sheep manure (SMC). The mineral (NPK) fertilizer was determined by the annual commercial offer for grapevine. Treatments were replicated following a random experimental design with three blocks; each block contained the five treatments randomly placed. Organic amendments were applied and incorporated into the soil in February every year for 14 years. In the case of statistical analyses, one-way ANOVA tests were used; to compare differences between treatments, Duncan test were performed with a significance level $P > 0.05$ using the SPSS software (SPSS 17, 2010).

Table 1. Physical and chemical properties of fertilizers. Pelletized organic compost (PEL), municipal solid waste compost (MSW), sheep manure compost (SMC) and Mineral (NPK)

	PEL	MSW	SMC	NPK
pH	7.74	7.94	8.51	2.87
Dry matter ((% p/p))	72.82	76.44	59.70	98.14
Organic matter (% sss)	59.54	41.83	47.17	N.D.
TOC (% C/dm)	19.61	23.68	24.28	N.D.
Nitrogen Kjeldahl (% N/dm)	4.75	5.49	5.52	6.43
N-NH ₄ (% P/dm)	0.30	0.28	0.04	N.D.
N-NO ₃ (% P/dm)	0.04	0.10	0.10	N.D.
δN ¹⁵	11.18 ± 0.12	10.45 ± 0.12	18.8 ± 0.13	0,08 ± 0,14
δC ¹³	-24.37 ± 0.17	-25.73 ± 0.17	-27.2 ± 0.17	N.D.

N₂O, CO₂ and CH₄ were measured 2,3,5,10,15,21,45,60, 90 and 115 days after fertilization, using closed chambers. Emission rates were determined using closed chamber technique, taking into account the concentration increase with time (Menéndez et al., 2008). Samples were analysed by

gas chromatography (Agilent, 7890A) with an electron capture detector. A capillary column (IA KRCIAES 6017: 240°C, 30 m x 320mm) was used. The column's temperature ramped from 40°C to 80°C and ECD's temperature was 350°C, and 5% mixture of Ar, with CH₄ was used as carrier and N₂ as make up (15 mL min⁻¹). A headspace autosampler (Teledyne Tekmar HT3) was connected to the gas chromatograph. Standards were stored and analysed at the same time as samples.

3. Results & Discussion

Although, treatments with organic amendments showed higher cumulative losses than mineral fertilizer, the Duncan test did not show significant differences between treatments (Table 1).

Table 2. Cumulative emissions up to day 115 after treatment application in February on the year 2010.

	kg N ₂ O-N ha ⁻¹	kg CO ₂ -C ha ⁻¹	g CH ₄ -C ha ⁻¹	Kg CO ₂ eq ha ⁻¹
Control	1.75 a	269 b	-19,50 a	1839 a
NPK	1.75 a	256 b	2,99 a	1787 a
PEL	1.96 a	377 ba	-68,39 a	2337 a
MSW	1.80 a	438 a	-37,32 a	2480 a
SMC	1.75 a	402 ba	-46,25 a	2323 a

Different letters indicate significantly different rates using Duncan Test (P<0.05; n=4)

The application of organic fertilizers induced an increase in soil organic matter contents (data not shown) and significant differences on CO₂ losses between organic treatments and Control and NPK treatments. Methane emissions were unaffected by the use of organic fertilizers. When the Global Warming Potential of the cumulative losses was calculated, no differences between treatments were observed.

4. Conclusion

Our results show that the greenhouse gas emissions from soil were not affected by the application of organic amendments, considering an end-point evaluation. Thus, the application of composted organic waste to agricultural soils can be a useful tool to reduce both the waste problem and N requirements for agriculture.

Acknowledgements

This work was supported by the Spanish Commission of Science and Technology (MCyT project number AGL2009-13339-C02-02). The current study involved the collaborative work between the "Navarre's Station of Viticulture and Oenology" (EVENA, Spanish acronym) and Public University of Navarre (UPNA, Spanish acronym). M.E. Calleja-Cervantes held a grant from the Public University of Navarre

References

- Bouwman, A.F. 1990. Exchange of greenhouse gases between terrestrial ecosystems and the atmosphere. In: Bouwman, A.F., (Ed.), *Soils and the Green House Effect*, Wiley, Chichester, pp. 61-127.
- IPCC, 1995. *Climate change Scientific and Technical Analysis of Impacts, Adaptions and Mitigation. Contribution of Working Group II to the Second Assessment Report of the Intergovernmental Panel on Climate Change*, Cambridge University Press, London.
- Freibauer, A., Rounsevell, M.D.A., Smith, P. and Verhagen, J. 2004. Carbon sequestration in the agricultural soils of Europe. *Geoderma* 122, 1-23.
- Menéndez, S., López-Bellido, R.J., Benítez-Vega, J., González-Murua, C., López-Bellido, L. and Estavillo, J.M. 2008. Long-term effect of tillage, crop rotation and N fertilization to wheat on gaseous emissions under rainfed Mediterranean conditions. *European Journal of Agronomy* 28, 559-569.

Coupling long term database with SWAT and STICS models for testing models and simulating nitrogen management scenarios

Deneufbourg, M.^a, Pugeaux, N.^b, Huguet, J.^b, Billy, C.^b, Duval, J.^b, Vandenberghe, C.^a, Marcoen, J.M.^a, Beaudoin, N.^b

^aUniv. Liège-Gembloux Agro-Bio Tech. Soil Science Unit. Passage des Déportés, 2. B-5030 Gembloux, Belgique

^bINRA Unité Agro-Impact. Pôle du Griffon, 02000 Barenton-Bugny, France

1. Background & Objectives:

Pollution of surface and ground water by nitrates released from agriculture at European scale (EU, 2010) combined with the global scarcity of raw materials makes better use of nitrogen (N) essential. The impact of changes in agricultural practices on receiving water bodies is difficult to evaluate in the long term because of the lag time of the aquifers and soils. Modeling nitrate leaching allows a prediction of nitrates concentration below the rooting zone and at the outlet of the watershed in the long term. The European funded project “Sustainable Use of Nitrogen” (SUN) aims to contribute to a sustainable management of N in agriculture in order to reduce the leaks towards water and air.

One objective of this project is to quantify the impact of different tactical or strategic N management scenarios in crop and fodder systems on nitrate leaching by modeling over 50 years the soil-crop-air system with the STICS and SWAT models applied to two watersheds. This paper is focused on the method and results of the coupling database-models.

2. Materials & Methods:

Study areas

The study areas are 2 watersheds (**Table 1**) in which monitor was carried out over a number of years (since 1990 in Bruyères and 2000 in Arquennes).

Table 1. Main characteristics of the study watersheds.

Name	Location	Area	Soil variability	Farming system	References
Arquennes	Southern Belgium (Wallonia)	78 ha	Low (loam/loam)	Mixed crop-livestock farming	Deneufbourg et al., 2010
Bruyères	Northern France	160 ha	High (loam, loamy clay, limestony loam)	Arable crops	Beaudoin et al., 2005

Models

Two different soil-crop models are being used: an agronomy oriented model, STICS (Brisson et al., 2003), previously spatially distributed (Schnebelen et al., 2004) and a hydrology oriented model, SWAT (Neitsch et al., 2005). The STICS model runs at a plot scale whereas the SWAT model runs at a catchment scale. Inputs of both models are climate, soils properties, land use, topography (only for SWAT) and agronomic practices. Outputs of both models are the crop yield, Leaf Area Index, biomass, water balance and N balance. For STICS, soil water content and soil mineral N content are additional studied outputs. The Arquennes watershed had already been modelled with the SWAT model in a previous study whereas the Bruyères watershed had previously been modelled with the STICS model.

Database

Data from field measurements in both watersheds, initially stored in spreadsheets, were sorted, standardized and inserted in a database managed with PostgreSQL (Duval et al., 2010).

Coupling database-models

An interface was developed to retrieve the required data in the database and to adapt their format to the input files of the STICS model (ESPIA project). Input files are obtained from field measurements and expert relation rules between simulation units. Agricultural

management input files of the SWAT model were also generated automatically but no interface was built.

3. Results & Discussion:

Preliminary results were obtained for crop yield and soil nitrogen content simulated with STICS and SWAT models on several parcels (from 1 to 10 ha) in Arquennes watershed from 2000 to 2007 (the Bruyères watershed still need to be fully modelled with the SWAT model). These parcels are considered to be representative of the context of the watershed. Up to now, we focused on sugar beet and potato crops. First results are presented in **Table 2**, as example.

Table 2. Observed and modelled (STICS and SWAT) mean annual yield and soil N content.

	Mean yield (t ha ⁻¹)			Mean soil N content (kg N ha ⁻¹)						
	STICS	SWAT	Observed	RMSE (t ha ⁻¹)		RMSE (kg N ha ⁻¹)				
				STICS	SWAT	STICS	SWAT	Observed	STICS	SWAT
Sugar beet	70.6	69.2	73.6	11.0	18.8	42.3	/	45.5	9.1	/
Potato	66.1	49.4	56.1	21.2	12.2	65.5	/	59.3	15.9	/

Sugar beet yield prediction is better with STICS than with SWAT for these parcels. STICS is initially a crop model and is logically more efficient to predict sugar beet yield in the context of Arquennes watershed. On the other hand, potato yield is overestimated by STICS in Arquennes watershed. Some parameters related to this crop need to be adjusted to predict more accurate yield.

Unfortunately, SWAT output files do not contain soil N content at field scale. Soil N content predicted by STICS is quite accurate for the two crops.

These results still need to be improved by an adaptation of some crop parameters to the context of the Southern Belgium. Crop yield and nitrogen transport will be simulated for all parcels of the watershed.

4. Conclusions:

Preliminary results allowed to reveal some differences between STICS and SWAT models and to test the coupling between database and models. Coupling database and models is a worthwhile approach which makes the use and comparison of several models easier.

References

- Beaudoin, N., Saad, J., Van Laethem, C., Maucorps, J., Machet, J.M. and Mary, B. 2005. Nitrate leaching in intensive arable agriculture in Northern France: effect of farming practices, soils and crop rotations. *Agriculture, Ecosystem and Environment* 111, 292-310.
- Brisson, N., Gary C., Justes, E., et al. 2003. An overview of the crop model STICS. *European Journal of Agronomy* 18, 309-332.
- Deneufbourg M., Vandenberghe, C. and Marcoen J.M. 2010. Mise en œuvre du Programme de Gestion Durable de l'Azote et évaluation d'impact à l'échelle d'un bassin versant agricole (Arquennes, Belgique). *Biotechnology, Agronomy, Society and Environment* 14 (S1), 27-38.
- Duval, J., Constantin, J. and Beaudoin, N., 2010. Interfaçage d'une base de données POSTGRESQL d'essais de longue durée avec le modèle STICS. Poster- Séminaire STICS ; 16-18 mars, Sorèze (F81).
- Neitsch, S.L., Arnold, J.G., Kiniry, J.R. and Williams, J.R., 2005. Soil and Water Assessment Tool Theoretical Documentation, Version 2005. Temple, Texas: USDA-ARS Grassland, Soil and Water Research Laboratory.
- Schnebelen, N., Nicoulaud, B., Bourennane, H., Couturier, A., Verbeque, B., Revalier, C., Bruand, A. and Ledoux E. 2004. The STICS model to predict nitrate leaching following agricultural practices. *Agronomie* 24, 423-435.
- UE, 2010 : Mise en œuvre de la directive 91/676/CEE du Conseil concernant la protection des eaux contre la pollution par les nitrates à partir de sources agricoles. Synthèse des rapports établis par les États membres pour la période 2004-2007. Commission Européenne. 13 pages.

Aknowledgements

We thank INTERREG EU (SUN), Picardie region (ESPIA) and Walloon Public Service.

Determination of nitrogen concentration in pig slurries using NIR spectroscopy

Fuccella, R.^a, Cabassi, G.^b, Marino Gallina, P.^a

^a Di.Pro.Ve. Department of Plant Production, Università degli studi di Milano, Milan, Italy

^b CRA-FLC Centro di ricerca per le Produzioni Foraggere e Lattiero-Casearie di Lodi, Lodi, Italy

1. Background & Objectives

The intensification of livestock breeding increases the availability of animal manures per unit of land area and can lead to over-fertilization of arable land with the risk of polluting surface and groundwater. To properly manage animal manures, it is essential to prepare nutrient management plans based on nutrient balances, which can be calculated only if manure nutrient concentrations are known. Traditional wet chemistry methods are not applicable to routine manure analysis due to costs and timing of implementation. Therefore it is necessary to develop new analytical methods, and those based on near infrared spectroscopy (NIRS) appear promising (De Ferrari et al., 2007; Sørensen L.K., 2007). It is also important to explore different NIR techniques and performances of laboratory and field portable spectrosopes. We compared two NIR spectrosopes differing in technology and price for the prediction the N concentration of pig slurries.

2. Materials & Methods

The sample set used for calibrations was composed of 91 pig slurries collected from heterogeneous livestock farms located in the Lombardia region, northern Italy, during 2010. We carried out calibrations for total Kjeldahl nitrogen (TKN) and ammonium nitrogen (NH₄-N). Samples were stored at 5°C for not more than 2 days, homogenized (25-50µm), characterized with standard analytical methods (Kjeldahl for TKN and steam distillation for NH₄-N) and then stored at -18 °C until the acquisition of NIR spectra. Some characteristics of the two spectrosopes are shown in Table 1.

Table 1. Instrumentation and settings used for the acquisition of NIR spectra

Instrumentation and builder	Technology	Spectral range and resolution	n° scans spectrum	Price
NIRMaster (Buchi - Italy)	Fourier transform interferometer	1000 – 2500 nm; 8 cm ⁻¹	64	60*10 ³ €
LAB POD TM (Polycromix-USA)*	Interferometer MEMS	1000 – 1800 nm; 12 nm	80	15*10 ³ €

* With probe Mobil light + fiber optic QP600-2-VIS-NIR (Polycromix - Wilmington, MA)

Spectra were acquired in diffuse reflectance mode using samples either as they were after thawing or mixed with silica sand. The silica sand was pre-treated at 550 °C. Samples were warmed at 20 °C on a Dubnoff bath just before scanning. At least three average spectra, obtained from three different fillings, were obtained for each sample. Chemometric analysis of the NIR spectra were performed using MatlabTM R2009b software (The Mathworks, Inc.) and PLS Toolbox (Eigenvector Research, Inc.). The following pre-treatments were applied to spectra: Extended Multiplicative Scattering Correction, Savitsky-Golay function and mean center. Outlier detection was obtained by principal components analysis (PCA) and by Q and Hotelling's T² test (95% confidence limit). Partial least squares (PLS) regressions models were developed and a random subset cross-validation with 8 numbers of data splits and 4 numbers of iterations was used for model development and validation. To judge the quality of NIR calibrations we followed the guidelines proposed by Malley et al. (2004) based on three indices: i) R² (coefficient of determination during validation); ii) RER (range error ratio; the ratio between the range of measured values and the RMSEP, Root Mean Squared Error of Prediction); iii) RDP (ratio of performance to deviation; the ratio between the standard deviation of the measured values and the RMSEP).

3. Results & Discussion

Descriptive statistics of the measured variables and the standard deviation of the reference methods are shown in Table 2. Most samples were very diluted and their very low dry matter content led to difficulties for the acquisition of useful spectra in the diffuse reflectance mode. In fact, with too low concentration of suspended particles, the radiation is not reflected to the detector just after a short path into the sample but it follows a long path into the highly absorbent water matrix. This results in more or less complete radiation extinction. The problem was particularly pronounced in the case of the Polycromix instrument. To overcome this problem samples were mixed with silica sand; the spectra obtained allowed the cross-validation results shown in Table 3.

Table 2. Descriptive statistics of N content in the pig slurries and standard deviation measured by reference analysis

Variable	u.m.	Mean	Population SD	Min	Max	SD of reference methods
NH ₄ -N	mg g ⁻¹ w.w.*	1.66	0.90	0.49	4.58	0.05
TKN	mg g ⁻¹ w.w.*	2.48	1.36	0.55	5.72	0.07

* wet weight

Table 3. Results of the cross validation of PLS regressions

Instrument	Variable	R ²	RMSECV*	RPD	RER	Classification	Mean Instrument	SD Instrument
Buchi	NH ₄ -N	0.97	0.15	6.0	27.3	Excellent	1.65	0.02
	TKN	0.97	0.23	5.9	24.5	Excellent	2.43	0.03
Polycromix	NH ₄ -N	0.75	0.44	2.0	8.1	Sufficient	1.62	0.43
	TKN	0.88	0.52	2.6	10.0	Fair	2.46	0.48

*RMSECV root mean square error of cross validation values mg g⁻¹ wet weight; ** in mg g⁻¹ w.w

To test whether the worse performances of the Polycromix instrument, compared to Buchi, were mainly due to its narrower wavelength range or to a lower resolution ability, additional calibrations were performed after reducing the Buchi spectra to the 1000-1800 nm range. The results obtained (see Table 4) show that the 1000-1800 nm range is not completely adequate for estimating nitrogen concentration in pig slurry. The two instruments gave similar performances in estimating TKN, while the Polycromix instrument was less accurate in estimating NH₄-N.

Table 4. Results of cross-validation of PLS regressions for NIRMasteR with reduced spectra.

Instrument	Range (nm)	Variable	R ²	RMSECV*	RPD	RER	Classification
Buchi	1000 - 1800	NH ₄ -N	0.86	0.33	2.7	12.3	Fair
	1000 - 1800	TKN	0.89	0.47	2.9	10.7	Fair

*RMSECV root mean square error of cross validation values mg g⁻¹ wet weight

4. Conclusions

The Buchi bench top spectroscope showed good predictive capabilities for TKN and NH₄-N concentration of pig slurries. The portable instrument LAB PODTM (Polycromix) was less accurate but still adequate and useful to improve current management of pig slurries, because the rates of application are normally calculated assuming categorized mean slurry N concentrations.

References

- De Ferrari G., Marino Gallina P., Cabassi G., Bechini L. and Maggiore T. 2007. Near infrared spectral analysis of cattle slurries from Lombardy breeding farms, In: Proceedings of the 12th International Conference Auckland, New Zealand 10-15/04/2005. In: Burling-Claridge G.R, Holroyd S.E., Sumner R.M.W. (eds).
- Malley D.F., Martin P.D. and Ben-Dor E. 2004. Application in Analysis of soils. American Society of Agronomy, Crop Science Society of America, Soil Science Society of America. Madison, Wisconsin, USA. Near Infrared Spectroscopy in Agriculture. Agronomy Monograph 44, 729-736
- Sørensen, L. K., Sørensen, P. and Birkmose T. S. 2007. Application of reflectance near infrared spectroscopy for animal slurry analyses. Soil Science Society of America Journal 71, 1398-1405

Differentiating sewage and manure derived nitrate within surface waters

Fenech, C.^a, Rock, L.^b, Nolan, K.^c, Tobin, J.^a, Morrissey, A.^d

^aSchool of Biotechnology, Dublin City University, Dublin 9, Ireland.

^bEnvironmental Engineering Research Centre, SPACE, Queen's University Belfast, N. Ireland.

^cSchool of Chemistry, Dublin City University, Dublin 9, Ireland.

^dOSCAIL, Dublin City University, Dublin 9, Ireland.

1. Background & Objectives

Nitrate is naturally found within the environment as part of the nitrogen cycle. However, anthropogenic sources have greatly increased nitrate loads within ground and surface waters. This has had a severe impact on aquatic ecosystems and has given rise to health considerations in humans and livestock. Therefore, efforts in nitrate sources determination have increased. Nitrate sources can be determined on the basis of the nitrogen (N) and oxygen (O) isotopic compositions ($\delta^{15}\text{N}$, $\delta^{18}\text{O}$) of nitrate. However, sewage and manure have overlapping $\delta^{15}\text{N}$ and $\delta^{18}\text{O}$ values (Figure 1), making their differentiation on this basis impossible. Hence, co-occurring discriminators of nitrate sources are required to differentiate between sewage and manure nitrate sources.

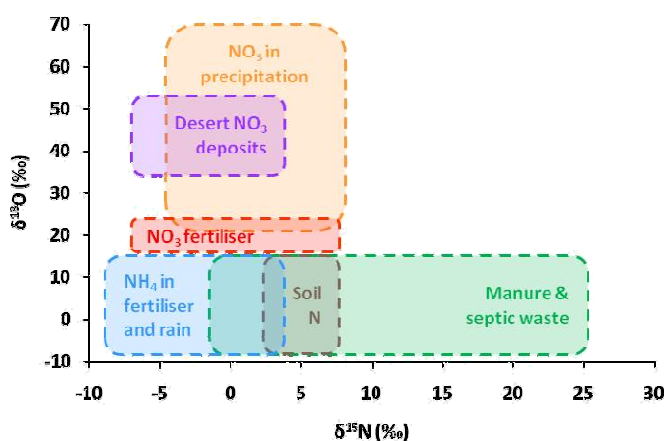

Figure 1. A general depiction of the normal range of $\delta^{18}\text{O}$ and $\delta^{15}\text{N}$ values for the dominant sources of nitrate Adapted from (Kendall, 1998).

In the present study, human and veterinary specific chemical markers are being assessed as markers of sewage and manure contamination respectively. Pharmaceuticals and related compounds such as metabolites and food additives have been detected within surface waters. They make ideal chemical markers as pharmaceuticals and related compounds are relatively water-soluble and non-volatile, and their natural background levels are low (Benotti and Brownawell, 2007). Furthermore, they are commonly persistent in order to avoid the substance becoming inactive before having a curing effect (Christensen, 1998; Halling-Sørensen et al., 1998; Jjemba, 2006; Enick and Moore, 2007). Therefore, through the careful choice of a suite of pharmaceuticals differentiation between sewage and manure nitrate sources may be possible.

2. Materials & Methods

A suite of 10 chemical markers suitable for the differentiation of sewage and manure within surface waters was identified. The chemical markers selected provide specific information about the sample being analysed. Apart from giving information about the source of nitrate being human (sewage) or veterinary (manure), further information can be elucidated from their presence or absence, such as whether the input is raw or treated sewage. An SPE-LC-MS method for their simultaneous

determination within surface waters has subsequently been developed. Method development initially consisted of identification and optimisation of the separate SPE, HPLC and MS portions, followed by combination to a single SPE-LC-MS method and its validation. This was used to analyse samples from two sites influenced by sewage or manure inputs over a 6 month period which could be integrated to isotopic data.

3. Results & Discussion

In order to ensure suitability of the developed method for such an application the final method was to meet a number of criteria. Firstly the analysis of the analytes should be carried out in a single method for simultaneous detection in order to improve sample throughput. Furthermore the limits of detection and quantification lie in the ng L^{-1} range, which corresponds to the concentrations at which such chemical markers occur within surface waters.

Waters OasisTM HLB SPE cartridges and a Waters SunfireTM C₁₈ 3.5 μm HPLC column were selected. In the optimised method, two mobile phases were used, where mobile phase A was acetonitrile with 0.1% ammonium acetate and mobile phase B was water with 0.1% ammonium acetate. A gradient flow was used from 10:90 to 60:40 A:B. UV detection was carried out at 206 nm and 200 nm, a 20 μL injection volume was used and the flow rate was set to 0.3 mL min^{-1} .

4. Conclusions

This work identifies a means to differentiate sewage and manure nitrate inputs to surface waters, which to date has not been possible. Such research is of interest to various stakeholders, in particular as it allows for more effective application of the 'polluter pays principle' and improved management of water bodies in the context of nitrate contamination, since the inputs can be identified. Furthermore, nitrate source determination is considered as an important factor for improving our health and environment, and it has a legislative importance in relation to the Water Framework Directive.

Further investigations that are ongoing involve different analytical techniques for using chemical markers for differentiating sewage and manure. Such research will be carried out with a view of reducing the sample preparation and method development requirements associated with the development and use of an SPE-LC-MS method.

References

- Benotti, M. J. and Brownawell, B. J. 2007. Distributions of Pharmaceuticals in an Urban Estuary during both Dry- and Wet-Weather Conditions. *Environ. Sci. Technol.* 41(16), 5795-5802.
- Christensen, F. M. (1998) Pharmaceuticals in the Environment—A Human Risk?, *Regul. Toxicol. Pharmacol.* 28(3), 212-221.
- Enick, O. V. and Moore, M. M. 2007. Assessing the assessments: Pharmaceuticals in the environment. *Environ. Impact Assess. Rev.* 27(8), 707-729.
- Halling-Sørensen, B., Nors Nielsen, S., Lanzky, P. F., Ingerslev, F., Holten Lützhøft, H. C., Jørgensen, S. E. (1998) Occurrence, fate and effects of pharmaceutical substances in the environment- A review. *Chemosphere* 36(2), 357-393.
- Jjemba, P. K. 2006. Excretion and ecotoxicity of pharmaceutical and personal care products in the environment. *Ecotoxicol. Environ. Saf.* 63(1), 113-130.
- Kendall, C. 1998. Tracing Nitrogen Sources and Cycling in Catchments. In: Kendall, C., McDonnell, J.J. (Eds.), *Isotope tracers in catchment hydrology*, Elsevier Science B.V., Amsterdam, 519-576.

Differentiation of N application standards: does it help reconcile economy and environment?

Ten Berge^a, H.F.M., Van Dijk^b, W., Burgers^c, S. L. G. E., Van der Schoot^b, J. R.

^a Plant Research International, P.O.B. 14, 6700 AA, Wageningen, The Netherlands

^b Applied Plant Research, Lelystad, P.O.B 167, 6700 AD, The Netherlands

^c Biometris, Wageningen, P.O.B. 14, 6700 AA, The Netherlands

1. Background & Objectives

Intensive cropping on light soils has led in many parts of Europe to excessive nitrate leaching. Various countries have introduced a system of nitrogen (N) application standards. These are fixed values for allowed N input per crop-soil combination, generally independent of expected yield. In the Netherlands, current N application standards for a number of arable and vegetable crops on sandy soils are still too high to meet the target nitrate concentration of 50 mg per litre in groundwater. Reductions of N application standards required to meet this target will cause yield loss. The central question in this study was: to what extent can this yield loss be avoided by differentiating N application standards to local conditions, without compromising environmental performance as expressed in N surplus ?

2. Materials & Methods

The hypothesis that differentiation could help resolve the conflict between economy and environment is based on the notion that high-yielding crops are more efficient in N uptake, as well as in utilising the acquired N to make harvestable crop produce. So, attainable yield (Y_{max} , yield unconstrained by N availability) was taken to be one of the 'local' conditions defining N application standards. The second one was N offtake from the soil (U_0), that is, N offtake in absence of fertiliser input. This parameter was used as a proxy for soil N supply, values for the latter being unavailable. Here, the hypothesis was that fertiliser N uptake and internal N utilisation by the crop are more efficient if soil N supply is low. Both these two 'local' parameters – Y_{max} and U_0 – can be inferred from N response trials. We analysed a total of 223 N response trials of ware potato, starch potato, winter wheat, spring wheat, spring barley, silage maize, onions and sugar beet. First, we tested the hypothesis that Y_{max} and U_0 do affect N uptake efficiency (apparent N recovery, ANR) and internal N use efficiency ($1/A$, with A for the N concentration in harvested product), and we quantified the relations between these variables by linear regression analysis. Second, we used the resulting regression equations to express actual (N-constrained) yield and N offtake (from soil plus fertilisers) as functions of Y_{max} , U_0 and fertiliser N rate. These functions were then used to address the question raised in the introduction. This was done in the form of a scenario study, where three levels of Y_{max} were crossed with three levels of U_0 , thus defining nine sets of local conditions: imaginary fields. Upper and lower values for Y_{max} and U_0 were well within the data range for each crop. The scenario study compared three situations. (A) The reference is N application equivalent to 70% of the current (2011) legal N application standards. All imaginary fields receive the same N rate. Total yield and total N surplus are calculated as the respective sums over all nine fields. (B) N distribution over the nine fields is optimised for maximum total yield, under the boundary condition of equal total N surplus as in (A). In Scenario (C), N distribution over the nine fields is optimised for minimum total N surplus under the boundary condition of equal total yield as in (A). The numerical optimisation in (B) and (C) was executed by Excel Solver.

3. Results & Discussion

Regression analysis confirmed that N uptake efficiency (ANR) as well as internal N utilisation ($1/A$) at given N rate increased with higher attainable yield (Y_{max}) and with lower soil N offtake (U_0). The effect of Y_{max} on A was highly significant ($p < 0.01$) in all crops. The same holds for the effect of U_0 on A, except in starch potato where the effect was just significant ($p < 0.05$). The positive effect of N rate on A was highly significant in all crops, and was linear or quadratic, depending on the crop. In all crops except sugar beet was the effect of Y_{max} on ANR highly significant. U_0 affected ANR in ware potato, starch potato, winter wheat, spring barley, silage maize (all $p < 0.01$), and in onion and sugar beet ($p < 0.05$). Only in spring wheat there was no such effect. The negative effect of N rate (again linear or quadratic) on ANR was highly significant in all crops, except sugar beet (n.s.). So, all in all, the notion that fertiliser N is more efficiently used when attainable yield is high and soil N supply is low, is considered a valid justification for the differentiation of N application standards to Y_{max} and U_0 . We leave aside here the difficulty that Y_{max} and U_0 cannot be known *ex ante* in the real world. Optimal N distributions were very similar between Scenarios (B) and (C), and both showed widely differing N rates between the nine imaginary fields. In both (B) and (C), N rate differed between fields by as much as 200 (potato, winter wheat), 180 (silage maize), 140 (spring wheat, onion) and 100 (sugar beet) kg per ha⁻¹. In Scenario (B), this differentiation to both parameters (Y_{max} and U_0) indeed helped to reduce yield loss, with strongest effects in maize and potato. While calculated yield loss in Scenario A was 6.42% (maize) and 5.82% (ware potato) relative to yield at the current (2011) N application standards, this loss was reduced to 1.23% (maize) and 3.17% (ware potato). In winter wheat, yield loss was reduced from 3.9% (in A) to 0% (B). In Scenario (C), differentiation reduced N surplus by 10 to 20 kg per ha⁻¹, depending on the crop. We also calculated the benefit of differentiation to Y_{max} only. This is of practical relevance, because records of actual historical yields can be documented by farmers, to justify increased N application standards, but soil N supply cannot be documented so easily. Simulations of differentiating N application standards to Y_{max} only, within the same scenarios applied to the nine imaginary fields, revealed that yield loss was reduced by only 1 or 2 %-points.

4. Conclusions

In virtually all crops studied here, the efficiencies of N uptake and internal N use are significantly determined by attainable yield and soil N offtake. Due to this pattern, optimal differentiation of N application standards for maximum production within environmental constraints results in widely differing N rates. This differentiation, however, can only contribute substantially to resolving the conflict between economy and environment if it addresses not only attainable yield but also soil N supply.

References

The reference list includes only the references to the sources (mostly in Dutch) that document the 223 N response trials. It is too long to include here, but is available upon request.

DMPP reduces N₂O losses and maintains wheat yield under humid Mediterranean conditions.Menéndez, S.^a, Huerfano, X.^b, Aizpurua, A.^c, González-Murua, C.^b, Estavillo, J.M.^b^aAgrobiotechnology Institute (IdAB). Campus de Arrosadía, E-31192, Mutilva Baja, Spain^bDepartment of Plant Biology and Ecology, University of the Basque Country (UPV/EHU), Apdo. 644, E-48080 Bilbao, Spain^cNEIKER-Tecnalia. Dept. Ecotecnologías. Barrio Berreaga, 1. 48160 Derio (Bizkaia) Spain**1. Background & Objectives**

Agricultural intensification has led to the use of high inputs of nitrogen fertilizers into cultivated land. As a consequence, losses by nitrate leaching or gaseous emissions have increased significantly (Bouwman et al., 2002). Nitrification inhibitors have been shown to decrease N₂O emissions in grasslands (Menéndez et al., 2006; Pereira et al., 2010). The objective of this work was to evaluate the effect of 3,4-dimethylpyrazole phosphate (DMPP) on N₂O emissions during a whole wheat crop cycle and its possible effect on yield under humid Mediterranean conditions.

2. Materials & Methods

This work was conducted in a wheat crop in the Basque Country in 2010-2011 during a whole year, from wheat sowing in December 2010 to sowing of the next crop in November 2011. A randomized complete block factorial design with four replicates was established, with an individual plot size of 40 m². Three main treatments were applied: a control treatment without fertilizer, a second one with ammonium sulphate nitrate (ASN 26%) and a third one consisting in the combination of ASN with DMPP, available on the market as ENTEC 26. Nitrogen in ASN consisted of 7.5% nitric and 18.5% ammoniacal. Fertilization was split into two amendments: 14th March (tillering), when 60 kg N ha⁻¹ were applied and 12th April (stem elongation), when 120 kg N ha⁻¹ were applied. Grain yields were measured by harvesting an area of 1.5 × 8 m² per plot. N₂O emissions measurements were started on December 2010 after sowing and finished after a whole cropping season one year later. Measurements were conducted every two weeks, increasing the frequency to three days per week whenever the fertilizer was applied. Cumulative N₂O emission during the sampling period was estimated by averaging the rate of emission between two successive determinations, multiplying that average rate by the length of the period between the measurements, and adding that amount to the previous cumulative total. Nitrous oxide emission was measured using closed chambers (Menéndez et al., 2008). Samples were analysed by gas chromatography (GC) (Agilent, 7890A) equipped with an electron capture detector (ECD) for N₂O detection. A capillary column (IA KRCIAES 6017: 240°C, 30 m × 320 μm) was used and the samples were injected by means of a headspace autosampler (Teledyne Tekmar HT3) connected to the gas chromatograph. N₂O standards were stored and analysed at the same time as the samples.

3. Results & Discussion

ASN application increased N₂O emissions with respect to the unfertilized treatment (Table 1). These losses were 1.47 % of the nitrogen applied. This emission factor agrees with the IPCC (1996) guidelines which assume an N₂O emission factor of 1.25 ± 1.0% of fertilizer-N applied, but lower than those described by Ortiz-Monasterio et al. (1996) for irrigated wheat in Mexico (from 1.7 to 3.8 %) in a hot climate. The fact that under our humid Mediterranean conditions wheat does not need to be irrigated can reduce the losses with respect to other climatic zones. The percentage of reduction of N₂O losses in the ENTEC treatment with respect to ASN was 10 %. Although this percentage reduction is lower than described by other authors (Linzmeier et al., 2001; Weiske et al.

(2001) in areas with cold climates, in our humid Mediterranean conditions DMPP efficiently reduces N₂O losses up to the levels of the unfertilized treatment (Table 1).

Table 1. Cumulative N₂O losses and dry matter yield.

	Cumulative N ₂ O losses kg N ₂ O-N ha ⁻¹ year ⁻¹	Yield kg ha ⁻¹
Control	2.33 b	2564 b
ASN	2.66 a	7468 a
ENTEC	2.39 b	7536 a

Different letters indicate significantly different rates using Duncan Test (P<0.1; n=4)

The application of both fertilizers significantly increased grain yield with respect to the unfertilized treatment (Table 1). Nevertheless ENTEC had no significant effect on yield. This agrees with the results reported by other authors (Weiske et al., 2001).

4. Conclusion

In our humid Mediterranean conditions ENTEC efficiently lowers N₂O emissions up to the unfertilized levels, maintaining the same crop yield as with ASN fertilizer. Thus, the default emission factor for fertilizers with DMPP should differ from the emission factor for fertilizers without DMPP.

Acknowledgments

This project was funded by the Spanish Government (RTA2009-00028-CO3-03 and AGL2009-13339-CO2-01), by the Basque Government (K-EGOKITZEN, ETORTEK 2010-2012), K plus S Iberia S.L.-UPV/EHU (2011.0051) and by the University of the Basque Country (IT526-10).

References

- Bouwman, A.F., Boumans, L.J.M. and Batjes, N.H. 2002. Emissions of N₂O and NO from fertilized fields: summary of available measurement data. *Global Biogeochemical Cycles* 16, 1080, doi:10.1029/2001GB001812.
- IPCC (1996) Intergovernmental Panel on Climate Change. The science of climate change. In: Houghton JT, Meira Filho LG, Callander, BA, Harris, N, Kattenberg, A. and Maskell, K (eds) *Climate change 1995*. Cambridge University Press, Cambridge, p 22.
- Linzmeier, W., Gutser, R. and Schmidhalter, U. 2001. Nitrous oxide emission from soils and from a 15N-labelled fertilizer with the new nitrification inhibitor 3,4-dimethyl pyrazole phosphate (DMPP). *Biology and Fertility Soils* 34, 103-108.
- Menéndez S., Merino P., Pinto M., González-Mura C. and Estavillo J.M. 2006. 3,4-Dimethylpyrazol phosphate effect on nitrous oxide, nitric oxide, ammonia, and carbon dioxide emissions from grasslands. *Journal of Environmental Quality* 35, 973-981.
- Menéndez S., López-Bellido R.J., Benítez-Vega J., González-Murua C., López-Bellido L. and Estavillo J.M. 2008. Long-term effect of tillage, crop rotation and N fertilization to wheat on gaseous emissions under rainfed Mediterranean conditions. *European Journal of Agronomy* 28, 559-569.
- Ortiz-Monasterio, J.L., Matson, P.A., Panek, J. and Naylor, R.L. 1996. Nitrogen fertiliser management of N₂O and NO emissions in Mexican irrigated wheat. In: *Transactions Ninth Nitrogen Workshop*. Braunschweig, September, pp. 531-534.
- Pereira, J., Fanguero, D., Chadwick, D., Misselbrook, T.H., Coutinho, J. and Trindade, H. 2010. Effect of cattle slurry pre-treatment by separation and addition of nitrification inhibitors on gaseous emissions and N dynamics: A laboratory study. *Chemosphere* 79(6), 620-627.
- Weiske, A., Benckiser, G., Herbert, T., Ottow, J.C.G. 2001. Influence of the nitrification inhibitor 3,4-dimethylpyrazole phosphate (DMPP) in comparison to dicyandiamide (DCD) on nitrous oxide emissions, carbon dioxide fluxes and methane oxidation during 3 years or repeated application in field experiments. *Biology & Fertility of Soils* 34, 109-117.

Effect of nitrogen fertilization on nitrate leaching in relation to grain yield response in Sweden

Delin, S.^a, Stenberg, M.^a

^aDepartment of Soil and Environment, Swedish University of Agricultural Sciences, Skara, Sweden

1. Background & Objectives

Swedish farmers are encouraged to fertilize no more than the economic optimum in order to minimize nitrogen (N) leaching. Site-specific fertilization with respect to variation within fields could reduce N leaching further, but the effect would depend on the difference in leaching between fertilization above and below the optimum. To what extent the N leaching is affected above and below economical optimum varies in literature. According to Petersen and Djurhuus (2004) leaching is significantly increased already at rates below fertilizer recommendations, whereas Lord and Mitchell (1998) present data where leaching is affected only at rates above economical optimum. The objective of our study was to compare the effect of N fertilization on nitrate N leaching depending on grain yield response, i.e. above and below economical optimum in a cereal crop under Swedish weather conditions.

2. Materials & Methods

Nitrate N leaching in response to different fertilizer N doses was investigated at two sites in south-west Sweden. Five field trials in spring oat were conducted in 2007, 2008 and 2009 on a loamy sand and in 2009 and 2010 on a silty clay. Each trial had five or seven N fertilization treatments (0-150 % of recommended rate of ammonium nitrate) distributed randomly within four blocks. The subsequent crops (year two) were winter wheat or spring barley, which received normal fertilization rates (100 kg N ha⁻¹ in spring barley and 150 kg N ha⁻¹ in winter wheat) in all treatments. On the loamy sand, soil water was sampled using ceramic suction cups (Djurhuus, 1990) installed in triplicate at 80 cm depth in each plot. On the clay soil, plots with separate drainage systems at 1 m depth were used. Each plot had a separate collector for drainage water comprising a measuring station where the amount of drainage water from each plot was measured with a wagging vessel, and flow-proportional water samples were collected from each plot automatically. Sampling from both systems was carried out bi-weekly during periods with water flow through drainage, from the time of fertilization (April) until June the following year. The samples from suction cups were analyzed for nitrate and from the separate drainage system for both total N and nitrate N. Nitrate N leaching was determined from nitrate concentrations in soil water and discharge, accounting for both direct and residual effects. Grain yield was measured plot-wise by combine harvester and reported at 85% dry matter. Grain yield was plotted against N fertilization rate and fitted second order polynomials were used to estimate economic optimum N fertilization rates, when price ratio of grain to fertilizer is 10:1. In order to compare the influence of fertilization on leaching above and below optimum, the deviation in leaching from that in the unfertilized treatment was plotted against the deviation in fertilization from economical optimum fertilization rate.

3. Results & Discussion

On the sandy loam, the yield responded differently in different years, resulting in very different optimum N fertilisation rates (Figure 1A), ranging from 12 to 104 kg N ha⁻¹. On the silty clay, yield response was better in 2009 resulting in a optimum N fertilization rate of 130 kg N ha⁻¹ compared to 100 kg N ha⁻¹ in 2010 (Figure 1B). Nitrate leaching was not significantly affected below economical optimum, i.e. as long as each kg N ha⁻¹ of additional fertilisation led to at least 10 kg ha⁻¹

¹ increase in grain yield (Figures 1C and 1D). However, at larger N rates nitrate-N leaching increased exponentially at about 1-2 kg N ha⁻¹ for every 5 kg of extra N fertilizer applied at the loamy sand (Figure 1C) and 0.5 kg N ha⁻¹ leached for every 5 kg of extra N fertilizer applied at the silty clay (Figure 1D).

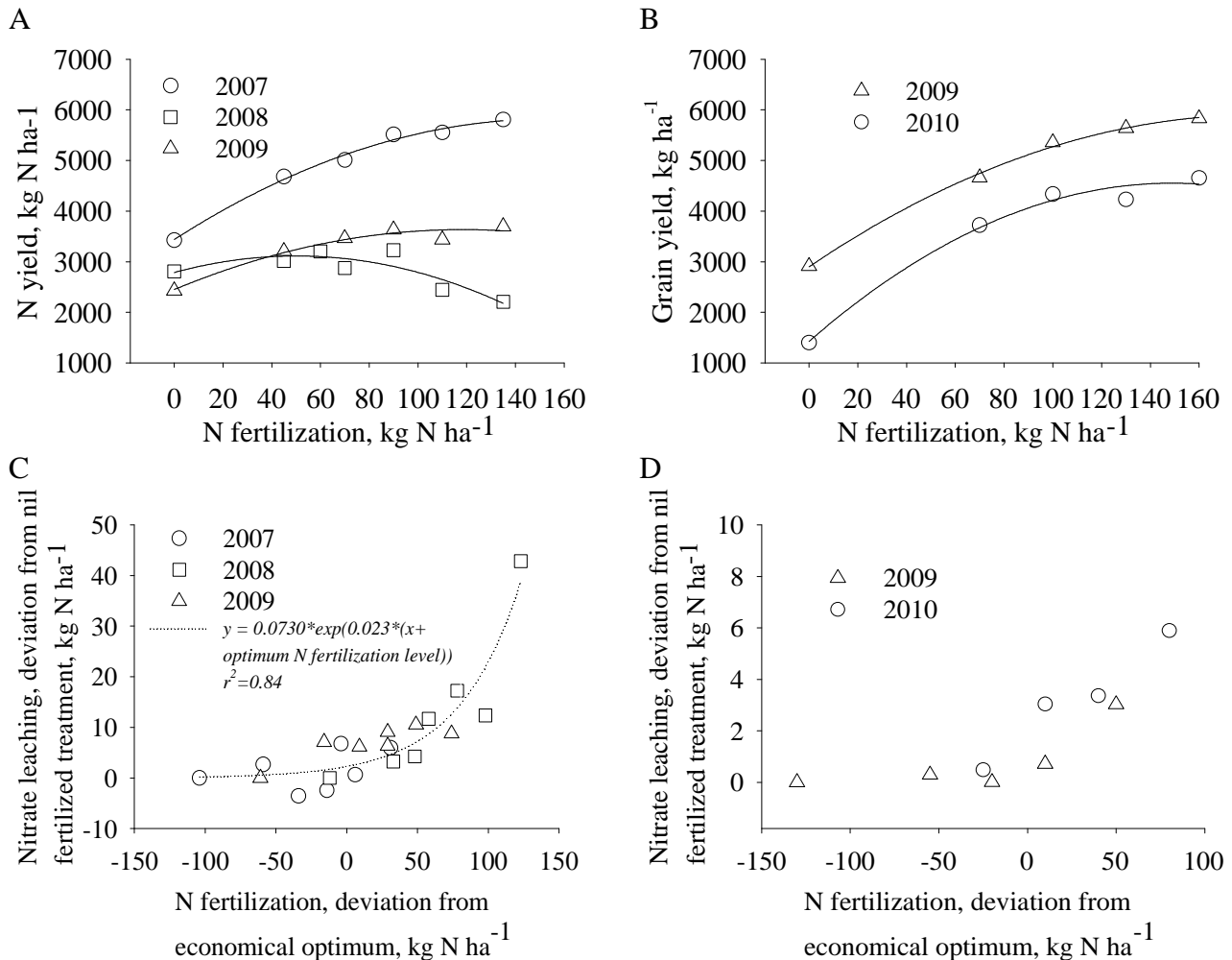

Figure 1. Grain yield at A) loamy sand B) silty clay and nitrate N leaching at C) loamy sand D) silty clay as a response on N fertilizer rate with quadratic polynomials fitted to yield data and exponential function fitted to N leaching data.

4. Conclusion

The difference in effect on leaching above and below economical optimum indicates that site-specific N fertilization has the potential to reduce N leaching as long as fertilization will be kept at or below economic optimum at a larger area of the land.

References

- Djurhuus, J. 1990. Sammenligning af nitrat i jordvand udtaget med sugkopper og ekstraheret fra jordprøver. Landbrugsministeriet, Statens Planteavlsvforsøg, Særtryk af Tidsskrift for Planteavl 94, 487-495.
- Lord, I.E. and Mitchell, R.D.J. 1998. Effect of nitrogen inputs to cereals on nitrate leaching from sandy soils. Soil Use and Management 14, 78-83.
- Peterssen, J. and Djurhuus, J. 2004. Sammenhæng mellem tilførsel, udvaskning og optagelse af kvælstof i handelsgødning, kornrige sædskifter. DJF rapport markbrug nr. 102, 55 s.

Effect of non-fertilized winter grazing dairy production on soil N balances and soil N dynamics in a clay-loam soil

Necpalova, M.^{a,b}, Phelan, P.^{a,b}, Casey, I.^b, Humphreys, J.^a

^a Animal and Grassland Research and Innovation Centre, Teagasc Moorepark, Fermoy, Co Cork, Rep of Ireland

^b Department of Chemical and Life Sciences, Waterford Institute of Technology Cork Road, Waterford, Rep of Ireland

1. Background & Objectives

Soil surface nitrogen (N) balances and soil soluble N pools are often analysed to evaluate nutrient management practices on the soil surface. Winter grazing under moist temperate conditions has a high potential to affect soil N dynamics. The objective of this study was to investigate the effect of non-fertilized winter grazing dairy production on soil surface N balances and soil soluble N dynamics in a clay loam soil profile on a dairy farm in south Ireland over two production years.

2. Material & Methods

The systems were: (i) ES-100N–Early spring calving with 100 kg ha⁻¹ of fertilizer N (Feb, March, Apr):grazed from Feb to Nov and stocked at 2.1 cows ha⁻¹; (ii) ES-0N–Early spring calving without fertilizer N: grazed from Feb to Nov and stocked at 1.6 cows ha⁻¹; (iii) LS-0N–Late spring calving without fertilizer N: stocked at 1.7 cows ha⁻¹ between calving and 1st Sept and then 1.3 cows ha⁻¹ until the end of Jan since extra 3.7 ha was added to the system area. Each system consisted of six paddocks (>1 ha) on a clay-loam soil (28% clay). The excreta from housed animals were collected in a single tank. Soil surface N balances for each paddock and each year were calculated in accordance with the methodology of the Organisation for Economic Co-operation and Development (OECD, 2001). Inputs included N entering the soil through the soil surface as mineral fertilizer N, slurry, animal excreta, atmospheric deposition and white clover biological N fixation (BNF). Outputs consisted of N leaving the soil as harvested and grazed herbage. The soil surface N surplus was calculated as the difference between N inputs and outputs. Nitrogen fluxes were quantified and expressed on an annual basis. The quantities of N excreted by animals were calculated as the difference between N intake in feeds and N output in milk and calves, accounting for live weight change (Powell et al., 2006). Nitrogen excreted in each paddock was estimated according to the number of grazing days in the particular paddock. Atmospheric deposition was measured in situ. Biological N fixation was estimated using an empirical model (Humphreys et al., 2008), based on herbage yields and white clover content. Nitrogen removed in herbage was estimated from pre-grazing and pre-harvest herbage cuts (Humphreys et al., 2008) and herbage N content. Soil samples were taken from four paddocks per system eight times during the study period. At each sampling, 15 cores per paddock were taken using a hydraulic auger. Each core was subdivided into depths: 0 to 0.3 m, 0.3 to 0.6 m and 0.6 to 0.9 m and bulked to a composite sample at each depth within each paddock. Immediately after sampling, extracts were obtained by shaking in 2M KCl continuously for three hours at solution ratio of 2:1 (400ml:200 g, ratio v/w). Ammonium N and total oxidised N (TON) were determined using Aquakem 600 Discrete analyser. Total soluble nitrogen (TSN) was measured using a Shimadzu TOC-VCPH analyzer. Soluble organic N (SON) was calculated as the difference between TSN and inorganic N (TON+Ammonium N). Soil bulk density (BD) was measured as described by Blake and Hartge (1986). The results were expressed on an area basis using soil BD data for each depth. The experimental unit of the balances was a single paddock. The N flows were subjected to ANOVA (SAS Institute, 2009) examining the effects of the system, year and their interaction. Soil results were analysed as a repeated measure investigating the effect of the system, sampling depth and date, and their interactions. Simple linear regression was used to identify parameters that influenced soil N content.

3. Results & Discussion

Soil surface balances for the systems are presented in Table 1. Linear regression revealed a positive correlation between total N inputs and N uptake by herbage ($r^2=0.30$, $P<0.05$) and between total N inputs and TSN ($r^2=0.43$, $P<0.05$). Total soluble N was also correlated with N surplus ($r^2=0.36$, $P<0.05$). All soluble N species decreased with sampling depth ($P<0.0001$) and exhibited high temporal variation ($P<0.0001$). Soluble inorganic N content at each sampling depth (<0.9m) was not significantly affected by system operated on the soil surface. However, SON was influenced by system and sampling date interaction down to 0.6 m ($P<0.05$). In all systems, TON at each sampling depth increased between March and August and then decreased during winter months due to N leaching. Ammonium N and SON were not as dynamic as TON and both of them displayed a similar seasonal pattern under all systems. Ammonium N ($r^2=0.72$, $P<0.00001$) and SON ($r^2=0.38$, $P<0.0001$) were positively related to gravimetric soil moisture content. In contrary, TON content was negatively related to effective rainfall ($r^2=0.35$, $P<0.0001$) and positively related to soil temperature ($r^2=0.47$, $P<0.0001$). This signifies its dependence on microbial activity and biochemical processes, and also its susceptibility to leaching during winter.

Table 1. Soil surface N balances for the three dairy production systems. Standard deviations of the means are in parentheses. Superscripts indicate which means are significantly different from one another on the basis of Tukey test.

N flow (kg ha ⁻¹ yr ⁻¹)	ES-100N	ES-0N	LS-0N	System	Year	System x year
N in mineral fertilizer	100.0	0.0	0.0			
BNF	66.3 (31.76) ^b	112.3 (41.35) ^a	133.8 (56.45) ^a	$P<0.05$	$P=NS$	$P<0.05$
N in excreta during grazing	119.2 (32.02) ^a	95.2 (14.14) ^{ab}	82.2 (42.91) ^b	$P<0.05$	$P=NS$	$P=NS$
N in slurry	109.1 (85.9)	109.0 (54.59)	103.0 (54.71)	$P=NS$	$P=NS$	$P=NS$
Atmospheric deposition	6.5	6.5	6.5			
Total N input	401.2 (99.08)	322.8 (71.38)	325.2 (90.27)	$P<0.05$	$P=NS$	$P=NS$
N removed in herbage	227.1 (41.15)	190.8 (30.14)	200.4 (46.55)	$P=NS$	$P=NS$	$P=NS$
N surplus	174.1 (95.55)	132.0 (71.34)	124.8 (100.21)	$P=NS$	$P=NS$	$P=NS$

4. Conclusion

The non-fertilized winter grazing dairy production system operated on a heavy textured clay loam soil did not affect annual soil surface N surplus and soil soluble N dynamics in the soil profile compared to the other systems. Seasonal changes in soluble N pools were driven by soil moisture content and soil temperature, which are the most important factors controlling microbial activity and biochemical processes.

Acknowledgement

This study was funded by the Department of Agriculture, Fisheries and Food (RSF07-511)

References

- Blake G.R. and Hartge K.H. 1986. Bulk Density. *Agronomy* 9, 363-375
- Humphreys J. O'Connell, K. and Casey I.A. 2008. Nitrogen flows and balances in four grassland-based systems of dairy production on a clay-loam soil in a moist maritime environment. *Grass and Forage Science* 63, 467-480.
- OECD (2001) Methods and Results. In: *Environmental Indicators for Agriculture*, vol. 3. Organisation for Economic Co-operation and Development, Paris, France.
- Powell, J.M., Wattiaux, M.A., Broderick, G.A., Moreira, V.R. and Casler, M.D. 2006. Dairy diet impacts on fecal chemical properties and nitrogen cycling in soils. *Soil Science Society of America Journal* 70, 786-794.

Effect of non-fertilized winter grazing dairy production system based on a clay-loam soil on N leaching to groundwater

Necpalova, M.^{a,b}, Fenton, O.^c, Casey, I.^b, Humphreys, J.^a

^a Animal and Grassland Research and Innovation Centre, Teagasc Moorepark, Fermoy, Co Cork, Rep of Ireland

^b Department of Chemical and Life Sciences, Waterford Institute of Technology Cork Road, Waterford, Rep of Ireland

^c Environmental Research Centre, Teagasc, Johnstown Castle, Co. Wexford, Rep of Ireland

1. Background & Objectives

Implementation of the Water Framework directive (2000/60EC) has created considerable pressure to lower nutrient losses to waterbodies. The objective of this experiment was to investigate if N concentrations and losses in shallow groundwater (<5 m below ground level) on a dairy farm in south Ireland could be correlated with three dairy production systems after migration through a soil with high natural attenuation capacity.

2. Material & Methods

The grass-clover based systems were: (i) ES-100N–Early spring calving with 100 kg ha⁻¹ of fertilizer N: grazed from February to November and stocked at 2.1 LU ha⁻¹; (ii) ES-0N–Early spring calving without fertilizer N: grazed from February to November and stocked at 1.6 LU ha⁻¹; (iii) LS-0N–Late spring calving without fertilizer N: stocked at 1.7 LU ha⁻¹ between calving and 1st September and then 1.3 LU ha⁻¹ until closing date at the end of January. Each system consisted of 16 plots (>1 ha) on a clay-loam (clay 28%) soil with high soil organic C (4.48%) in the upper 0.3 m. The shallow groundwater monitoring was carried out over two drainage seasons. Five screened piezometers were installed in each plot, 240 piezometers in total. The slotted screen opening interval on the lower 0.2 m of the casing was covered by a filter sock. The annulus between casing and the piezometer wall was grouted with sand and bentonite on the soil surface. Samples were taken fortnightly after purging the piezometers during the main drainage period and after periods of high rainfall during other times of the year. Sampling was conducted 19 and 12 times during drainage seasons 2008-09 and 2009-10, respectively. A 50 ml sample was then taken from each piezometer, bulked to a composite sample per plot and filtered. Total dissolved N (TDN) was measured using a Shimadzu TOC-VCPH analyzer. Total oxidised N (TON), nitrite N (NO₂-N) and ammonium N (NH₄-N) were analysed on a Thermo Konelab analyser. Nitrate N (NO₃⁻-N) was calculated as the difference between TON and NO₂⁻-N. Dissolved organic N (DON) was calculated as the difference between TDN and dissolved inorganic N (DIN, NO₃-N + NO₂-N + NH₄-N). Weather data were recorded at the meteorological station on the farm. Effective rainfall (ER) was calculated using the hybrid grassland model of Schulte et al. (2005) based on poorly drained criterion. Losses of N for each system after natural attenuation during migration through the unsaturated zone were estimated by multiplying the mean N concentrations recorded on the sampling date with the volume of ER between two sampling occasions. The vertical travel time was calculated as Fenton et al. (2011). Concentration variables were subjected to ANOVA as a repeated measure (SAS Institute, 2009) examining the effects of the system, sampling date and all their interactions. Similarly, the annual N losses were subjected to ANOVA as a repeated measure investigating the effect of the system, year and their interactions.

3. Results & Discussion

Over the first sampling period, the site received a rainfall of 923 mm of which ER was 728 mm. The amount of rainfall during the second period was higher (1291 mm) and ER was only slightly different (751 mm). Vertical travel times to the watertable ranged from 0.2 to 0.5 yr⁻¹. Nitrate N was

below maximum admissible concentration (MAC) for groundwater (11.3 mg L^{-1}) but DON and NH_4^+ -N were high. Considering the high soil moisture content, heavy texture of the soils and high soil organic C content down to 0.9 m in the soil profile, low NO_3^- -N is likely attributable to soil attenuation processes such as dissimilatory NO_3^- reduction to NH_4^+ (DNRA) or denitrification which consequently resulted in increased NH_4^+ -N levels. There was a significant two way interaction of system and sampling date at concentrations of DON, TON and NO_3^- -N. In contrast, concentrations of NH_4^+ -N and NO_2^- -N were unaffected by the systems. All N concentrations were independent of weather variables indicating control by soil parameters and biochemical processes rather than by ER. Losses of all N species from the systems buffered by natural soil attenuation are presented in Table 1. Due to high attenuation capacity, NO_3^- -N comprised only a small proportion of the N lost to groundwater and DON and NH_4^+ -N represented 74 and 11% of overall losses, respectively.

Table 1 Mean annual losses ($\text{kg ha}^{-1} \text{ yr}^{-1}$) of N species to groundwater from three dairy production systems with standard deviations in brackets. ES-100N - early spring calving with Fertiliser N. ES-0N - early spring calving without Fertiliser N. LS-0N - Late spring calving without Fertiliser N.

	August 2008 - February 2009			February 2009 - February 2010			P values		
	ES-100N	ES-0N	LS-0N	ES-100N	ES-0N	LS-0N	System	Year	Interaction
Total N	22.9 (7.89)	21.4 (4.65)	20.0 (4.80)	19.2 (13.08)	18.4 (11.66)	19.3 (8.95)	NS	NS	NS
DON	19.1 (5.39)	17.2 (2.76)	16.5 (3.44)	14.1 (11.04)	10.6 (4.48)	11.7 (4.72)	<0.05	<0.0001	NS
Ammonium N	1.9 (2.76)	1.4 (0.37)	1.3 (0.34)	2.6 (2.18)	3.2 (4.51)	3.0 (2.56)	NS	<0.05	NS
TON	1.9 (0.64)	2.9 (2.70)	2.3 (1.57)	2.8 (1.16)	3.8 (2.45)	3.6 (2.45)	NS	<0.05	NS
Nitrite N	0.0 (0.03)	0.0 (0.04)	0.0 (0.05)	0.1 (0.05)	0.1 (0.12)	0.1 (0.10)	NS	<0.05	NS
Nitrate N	1.8 (0.62)	2.8 (2.7)	2.2 (1.52)	2.8 (1.14)	3.7 (2.40)	3.5 (2.44)	NS	<0.05	NS

4. Conclusion

Vertical travel time of approximately a drainage season due to a shallow watertable and high ER allowed correlations between nutrient losses and shallow groundwater nutrient concentrations within a small time lag period. However, the high natural attenuation capacity of the soil due to high C and anaerobic conditions ensured low concentrations of nutrients making correlations difficult. It was hypothesised that any losses from the winter grazing systems were instantaneously reduced by denitrification and DNRA, which consequently resulted in increased NH_4^+ -N levels. For this reason, DON and NH_4^+ -N represented the highest proportion of the N losses from the site presently migrating slowly towards receptors on site.

Acknowledgement

This study was funded by the Department of Agriculture, Fisheries and Food (RSF07-511)

References

- Directive 2000/60/EC establishing a framework for community action in the field of water policy. Official Journal of the European Union, L 327, 1–73.
- Fenton, O., Schulte, R.P.O., Jordan, P., Lalor, S. and Richards, K.G. 2011. Time lag: a methodology for the estimation of vertical and horizontal travel & flushing timescales to nitrate threshold concentrations in Irish aquifers. *Environmental Science & Policy* 14, 419-431
- Schulte, R.P.O., Diamond, J. Finkele, K., Holden, N.M. and Breton, A.J. 2005. Predicting the soil moisture conditions of Irish grasslands. *Irish Journal of Agricultural and Food Research* 44, 95-110

Effect of ploughing and reseeded of permanent grassland on N leaching to groundwater and nitrous oxide emissions from a clay-loam soil

Necpalova, M.^{a,b}, Casey, I.^b, Humphreys, J.^a

^a Animal and Grassland Research and Innovation Centre, Teagasc Moorepark, Fermoy, Co Cork, Rep of Ireland

^b Department of Chemical and Life Sciences, Waterford Institute of Technology Cork Road, Waterford, Rep of Ireland

1. Background & Objectives

Implementation of the Water Framework Directive (2000/60EC) and the Kyoto protocol in Ireland has constrained farmers to lower nitrogen (N) fluxes to the environment. Cultivation of permanent grassland increases the rate of mineralization of soil organic matter and thus promotes N losses via leaching and denitrification. The objective of this study was to examine the effect of ploughing and reseeded of permanent grassland on (i) N leaching to shallow groundwater (<5 m below ground level) over two drainage seasons (Aug 2008-Feb 2010); and (ii) nitrous oxide (N₂O) emissions over a year (Jan 2009-Dec 2009) on a dairy farm in southern Ireland.

2. Material & Methods

The treatments were: (i) permanent grassland [PG] and (ii) ploughed and reseeded grassland [RG] on a clay-loam soil (28% clay) with high N (0.48%) in the top 0.3 m; replicated 18 and 4 times for leaching and denitrification experiments, respectively. The RG was introduced in June 2008. Five screened piezometers were installed in each plot (>1 ha), 180 piezometers in total. The slotted screen opening interval on the lower 0.2 m of the casing was covered by a filter sock. The annulus between the casing and the piezometer wall was grouted with sand and bentonite on the soil surface. Groundwater samples were taken fortnightly after purging the piezometers during the main drainage period and after periods of high rainfall during other times of the year. Sampling was conducted 19 and 12 times during the drainage seasons 2008-09 and 2009-10, respectively. A 50 ml sample was then taken from each piezometer, bulked to a composite sample per plot and filtered. Total dissolved N (TDN) was measured using a Shimadzu TOC-VCPH analyzer. Total oxidised N (TON), nitrite N (NO₂-N) and ammonium N (NH₄-N) were analysed on a Thermo Konelab analyser. Nitrate N (NO₃⁻-N) was calculated as the difference between TON and NO₂⁻-N. Dissolved organic N (DON) was calculated as the difference between TDN and dissolved inorganic N (DIN, NO₃-N + NO₂-N + NH₄-N). Weather data were recorded at the meteorological station on the farm. Effective rainfall (ER) was calculated using the hybrid grassland model of Schulte et al. (2005) based on the poorly drained criterion. Losses of N for each treatment after natural attenuation during migration through the unsaturated zone were estimated by multiplying the mean N concentrations recorded on the sampling date with the volume of ER between two sampling occasions. The N₂O fluxes were measured fortnightly using a static chamber technique; in total 22 times. On each sampling day, ten iron chambers (diameter =11.5 cm, height = 14.5 cm) per plot were driven into the soil to a depth of 0.01 m randomly across each plot. Headspace gas samples were taken after 20 minutes incubation, and transferred to 7 ml pre-evacuated septum-sealed screw-capped glass vials using a 25 ml polypropylene syringe. At the same time two background gas samples were taken from each plot. Gas samples were analyzed using a gas chromatograph (Varian GC 450; The Netherlands) fitted with an electron capture detector at 300°C and automatic sampler. Hourly N₂O fluxes for each chamber were estimated from the slope of the linear increase between background level and concentration after incubation. All N concentrations and N₂O fluxes were subjected to ANOVA as a repeated measure (SAS Institute, 2009) examining the effects of cultivation, sampling date and their interaction. Similarly, the annual losses were subjected to ANOVA as a repeated measure investigating the effect of cultivation, year and their interaction.

Table 1. Mean annual losses of N species to groundwater from permanent and cultivated grassland with standard deviations in the brackets. Superscripts indicate which means are significantly different on the basis of Tukey test.

kg ha ⁻¹ yr ⁻¹	Aug 2008 - Feb 2009		Feb 2009 - Feb 2010		P values		
	Permanent	Cultivated	Permanent	Cultivated	Cultivation	Year	Interaction
Total N	22.89 (6.99) ^a	24.62 (6.08) ^a	18.39 (10.38) ^b	16.89 (10.12) ^b	NS	<0.005	NS
DON	18.62 (4.73) ^a	18.24 (2.73) ^a	10.54 (4.53) ^b	9.60 (5.61) ^b	NS	<0.0001	NS
Ammonium N	1.85 (2.34) ^b	1.30 (0.53) ^b	3.15 (3.83) ^a	3.56 (5.74) ^a	NS	<0.05	NS
Oxidised N	2.43 (1.63) ^b	5.08 (4.34) ^a	4.20 (2.76) ^b	4.19 (3.61) ^a	<0.05	NS	<0.05
Nitrite N	0.04 (0.05) ^b	0.12 (0.12) ^a	0.09 (0.09) ^b	0.08 (0.11) ^a	<0.05	NS	<0.05
Nitrate N	2.39 (1.59) ^b	4.95 (4.22) ^a	4.13 (2.72) ^b	4.11 (3.54) ^a	<0.05	NS	<0.05

3. Results & Discussion

The ER during the first and second sampling periods was 728 and 751 mm, respectively. All concentrations of N species in shallow groundwater exhibited high temporal variation ($P < 0.001$). Cultivation increased concentrations of TON, NO_3^- -N, NO_2 -N ($P < 0.0001$) and C:N ratio ($P < 0.05$) as a result of accelerated mineralisation of soil organic matter. The DON was affected by two way interaction between cultivation and sampling date ($P < 0.05$) and NH_4 -N was not affected by ploughing. Annual losses of oxidised N species buffered by natural soil attenuation were affected by interaction between cultivation and year ($P < 0.05$). This indicated that the increase in TON leaching was more pronounced during first year after cultivation (Table 1). Since ER caused similar recharge during both sampling periods, year to year variation in the DON ($P < 0.0001$) and NH_4 -N (< 0.05) losses may be caused by enhanced mineralization of dissolved organic matter to NH_4 -N in the second year. Cultivation also increased N_2O emissions ($P < 0.001$). The instantaneous fluxes ranged between -72 to $382 \mu\text{g N}_2\text{O m}^{-2} \text{h}^{-1}$ from PG and between -72 to $788 \mu\text{g N}_2\text{O m}^{-2} \text{h}^{-1}$ from RG (Fig.1) and the annual fluxes of N_2O from PG and RG were 1.32 ± 3.90 and $2.49 \pm 6.04 \text{ kg N ha}^{-1}$.

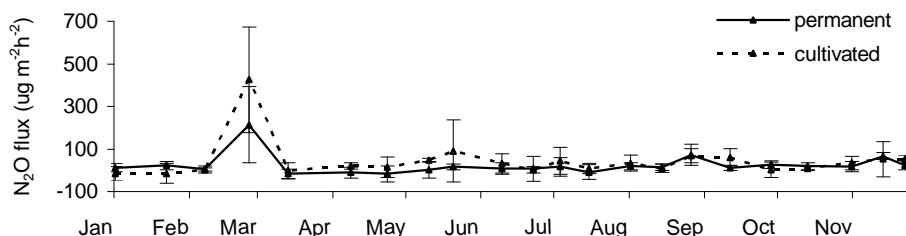
Figure 1. Nitrous oxide fluxes ($\mu\text{g m}^{-2} \text{h}^{-1}$) from permanent and cultivated grassland.

4. Conclusion

Ploughing and reseeded of PG increased TON leaching and N_2O emissions from the soil surface; however, the overall N losses were quite low. Due to high soil organic C and anaerobic status of heavy textured soils on site, it was assumed that N losses caused by cultivation were reduced by complete denitrification and consequently resulted in molecular N emissions.

Acknowledgement

This study was funded by the Department of Agriculture, Fisheries and Food (RSF07-511)

References

- Directive 2000/60/EC establishing a framework for community action in the field of water policy. Official Journal of the European Union, L 327, 1–73.
- Schulte, R.P.O., Diamond, J., Finkelle, K., Holden, N.M. and Breton, A.J. 2005. Predicting the soil moisture conditions of Irish grasslands. Irish Journal of Agricultural and Food Research 44, 95–110

Evaluating innovative farming systems to limit nitrogen diffuse pollution in catchments: development and application of the CASIMOD’N model

Durand, P.^{a,b}, Moreau, P.^{a,b}, Baratte, C.^{d,b}, Faverdin, P.^{d,b}, Gascuel-Oudou, C.^{a,b}, Ramat, E.^c, Ruiz, L.^{a,b}, Salmon-Monviola, J.^{a,b},

^a INRA, UMR1069 Sol Agro et hydrosystème Spatialisation, F-35000 Rennes, France

^b Agrocampus Ouest, UMR1069 Sol Agro et hydrosystème Spatialisation, F-35000 Rennes, France

^c ULCO, UPRES EA 4029 Laboratoire d’Informatique du Littoral, F-62228 Calais, France

^d INRA, UMR1080 Production du Lait, F-35590 St-Gilles, France

1. Background & Objectives

The European Union (EU) states that all water bodies need to recover a “good and non-deteriorating” ecological status by 2015. The catchment is the scale where both (i) the impacts of nitrogen diffuse pollution from agriculture are visible and (ii) the territorial policies are discussed and implemented. On the other hand, the farming system is the scale where management practices are decided by the farmers. The farming system can be defined as a combination of the anthropogenic decision system and the biotechnical system (Gouttenoire et al., 2010). The management practices express and materialize the farmer decisions which can be modulated by the feedbacks from the biotechnical system. Integrating farm and catchment scales and the interactions between decisional, biotechnical and biophysical systems can provide powerful tools to build and evaluate innovative farming systems aiming at reducing nitrogen losses. The objective of this paper is to present the newly-developed integrative tool CASIMOD’N (Catchment and Agricultural System Integrated MODEL for Nitrogen). Its validation and application on a 60 km² catchment, in which cattle production dominates, will be discussed.

2. Materials & Methods

CASIMOD’N aims at ensuring farm consistency (e.g., matching feeding needs and effluent production of livestock with crop plans and management practices), by modeling farmer strategy and subsequent practices and to model the nitrogen transfer and transformation at the catchment scale. It results mainly from the coupling of a farm model and an agro-hydrological model. The farm model was based on the existing TOURNESOL and FUMIGENE models (Chardon et al., 2008), and allowed simulating crop allocation and manure spreading in mixed farming systems. It allowed considering multiple farm structures and strategies. The strategy was implemented by setting the farmer preferences in the feeding ration and assigning a set of priorities to each crop, waste management and time of application for each field. The hypothesis underlying the crop allocation modeling was that in dairy farms, the feeding requirements of the herd are a major driver of farmer strategy to design cropping plans. Crop allocation and waste management were generated yearly for each farm during the simulation period. The agro-hydrological model was TNT2, topographic-based nitrogen transfer and transformations (Beaujouan et al., 2002). TNT2 is a detailed agro-hydrological model that simulated in a process-based, spatially distributed way the nitrogen transfers and transformations associated with management practices, crop growth and hydrological processes within the catchment. The application study site was a catchment located in Brittany, France, where the river flows in a bay severely affected by massive algae proliferation. Surveys were conducted on 54 farms and crop successions on each field were extracted from remote sensing analysis from 1997 to 2006. The validation of the farming systems were performed by testing ability of the CASIMOD’N model to reproduce the crop succession and allocation, the management of mineral and organic fertilization and the satisfaction of the herd alimentation needs. Two prospective scenarios, based on indicators emerging from discussions among stakeholders and

decision makers were tested. These indicators have the ambition to be rather simple to compute, generic among the farming systems but still structuring the farming systems. The selected indicators were: (a) a maximum stocking rate of 1.4 Livestock Unit (LSU) per hectare of meadow, (b) a threshold of 100 kg N ha⁻¹ input nitrogen at farm scale.

3. Results & Discussion

The validation procedure confirmed CASIMOD'N ability to simulate the farming systems and their expressions through the management practices, as illustrated by the results of the satisfaction of the need for livestock alimentation at farm scale (Figure 1).

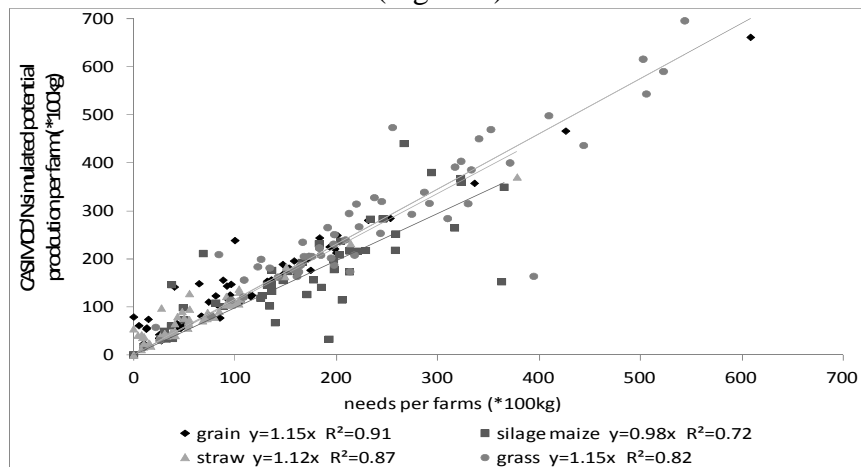

Figure 1. Evaluated need of grain, straw, silage maize and grass per farm compared to potential production simulated by CASIMOD'N

Figure 1 shows that in most cases the simulated scenario were compatible with maintaining the herd alimentation, but also highlighted some cases in which the farming systems could not comply with the proposed levels of the indicators. The simulation also suggested that this scenario would result in a significant decrease of N fluxes at the outlet of the catchment. Finally, the scenarios results gave valuable insights on the main components of N budget, with respect both to their temporal evolution and to their spatial distribution at the catchment scale.

4. Conclusion

The new tool developed in this work, based on the coupling of a farm and a catchment models, proved its efficiency in reproducing past agricultural practices, and in generating prospective scenarios consistent with the farming system constrains. It will be used within the AcaSSya project (ANR-08-STRA-01) as a complementary tool to help farmers and stakeholders to build effective scenarios aiming at reaching the water quality objective while maintaining viable farming systems.

References

- Beaujouan, V., Durand, P., Ruiz, L., Arousseau, P. and Cotteret, G. 2002. A hydrological model dedicated to topography-based simulation of nitrogen transfer and transformation: rationale and application to the geomorphology-denitrification relationship. *Hydrological Processes* 16, 493-507.
- Chardon, X., Raison, C., Le Gall, A., Morvan, T. and Faverdin, P. 2008. Fumigene: a model to study the impact of management rules and constraints on agricultural waste allocation at the farm level. *J. Agric. Sci.* 146, 521-539.
- Gouttenoire, L., Fiorelli, J.L., Trommenschlager, J.M., Coquil, X. and Cournut, S. 2010. Understanding the reproductive performance of a dairy cattle herd by using both analytical and systemic approaches: a case study based on a system experiment. *Animal* 4, 827-841.

Influencing factors on the nitrate residue levels in Flemish agricultural soils: a statistical analysis of 8 years of nitrate measurements

Tits, M.^a, Elsen, A.^a, Vandervelpen, D.^a, Bries J.^a, Vandendriessche, H.^a, Van Overtveld, K.^b, Diels, J.^b

^aSoil Service of Belgium, Heverlee, Belgium

^bDepartment of Earth and Environmental Science, K.U. Leuven, Belgium

1. Background & Objectives

In Flanders, nitrate residues in the soil profile are used as an indicator for the risk of nitrate leaching from agricultural soils to surface and ground water. The nitrate residue is defined as the amount of nitrate-N present in the soil profile (0-90 cm) during the period October 1st to November 15th. They are annually measured, on one hand in a (more or less) directed selection of agricultural parcels (commissioned by the Manure Bank) and on the other hand in all the parcels having an agro-environmental agreement “Water” (AEA Water). This produces datasets of 18 000 up to more than 30 000 nitrate residue measurements per year.

In the framework of the assignment of the Flemish Government to evaluate and differentiate the current nitrate residue standard, an extensive review of the historical nitrate residue measurements was made.

This descriptive analysis had to provide an answer to the following questions:

- which factors have a significant influence on the nitrate residue levels?
- what are the impacts of policy measures such as stricter fertilisation standards, agro-environmental agreements, etc.?

2. Materials & Methods

The available datasets for the analysis consisted of the nitrate residue measurements in parcels with AEA Water (173 022 usable measurements from 2001 to 2008) and the control measurements performed by the Manure Bank (35 916 usable measurements from 2004 to 2008). Despite the large size of the datasets, their representativeness for other agricultural parcels in Flanders is relative. The first dataset contains the complete population of all parcels with AEA Water in Flanders, but nitrate residues in these parcels are on average lower than in current agricultural parcels because of stricter fertilisation limits and a better implementation of optimal farming practices. The latter dataset consists each year of a directed sample of agricultural parcels towards derogation parcels, parcels in vulnerable zones, parcels in risk zones, parcels with a higher risk of excess fertilisation and a small amount of randomly selected parcels (5-10%). Therefore, it is assumed that an extrapolation of the results of this “non-random” dataset to the whole of Flanders would correspond to an overestimation of the nitrate residues. Despite these limitations, both datasets are considered as a unique and valuable resource to analyse the importance of influencing factors on nitrate residue levels.

For each measurement, additional information was available, such as sampling date, exact location of the parcel, main crop, catch crop (if present) and parcel surface. In addition, other datasets were linked containing climatic conditions, soil conditions (soil type, carbon content, pH), crop rotations, fertilisation limits and data on farm level concerning fertiliser use and manure production. Prior to the statistical analyses, a log-transformation had to be applied on the nitrate residue data in order to meet the statistical requirements of normality and homoscedasticity. The influence of the different parameters on the nitrate residues was then analysed through AN(C)OVA and regression techniques with the Statistica software (Statsoft Inc., 2007).

3. Results & Discussion

Between both datasets (parcels with AEA Water and control measurements), significant differences in nitrate residue levels exist. On average nitrate residues in AEA Water parcels were lower (-22 kg N ha^{-1}) than nitrate residues in the control measurements. This difference is mainly caused by the applied fertilisation practices. In parcels with AEA Water, fertilisation is generally better tuned to crop needs and as a consequence, effects of other parameters are smaller.

In both datasets, AEA Water parcels and control measurements, the nitrate residues show a significant decrease over the years. This decrease is attributed to a combined effect of stricter fertilisation limits and a gradual adoption of these limits in the farming practice, increased attention of the farmers to manuring practices and a better follow-up of fertilisation advices. Next to the generally decreasing trend in nitrate residues, the crop type is by far the most determining factor. Grass and fruit trees show significantly the lowest nitrate residues ($42\text{-}68 \text{ kg N ha}^{-1}$), followed by sugar beets. Leguminosae, potatoes and vegetables give on average the highest nitrate residues ($73\text{-}127 \text{ kg N ha}^{-1}$). Maize and cereals give intermediate values.

The effect of catch crops was considered per crop type. A catch crop after cereals is particularly important because cereals are harvested relatively early. From the results it appeared that yellow mustard sown as a catch crop after cereals reduced the nitrate residues significantly more than grassy catch crops. This is explained by the slower initial growth of grass. The effect of catch crops reflects in fact the effect of the presence of a crop and of the development (rooting) of this crop. A well developed (main or catch) crop at the moment of sampling absorbs the mineral nitrogen in the soil profile, leaving behind a smaller amount of nitrate. After crop types such as sugar beets and maize, the effect of catch crops on nitrate residues is less pronounced, because these crops have been harvested shortly before or even after the time of sampling and only limited nitrogen mineralisation has taken place since then. The carbon content of the ploughing layer (0-30 cm) has a significant and relatively important effect on the nitrate residues. Moreover, significant interaction effects were found between carbon content, soil pH and soil texture. Nitrate residues increase with increasing soil carbon contents. With higher pH-values and in heavier soil textures (loamy and clayey soils), this increase is more pronounced. Other parameters also had a significant effect on nitrate residues, such as agricultural region, soil type, climatic conditions, and farm type (with or without animals), but the relative importance of these parameters to explain the variation in the datasets was limited.

4. Conclusion

The extensive analysis of the available nitrate residue measurements in Flanders since 2001 demonstrates the importance of fertilisation practices and policy measures. Parcels with an AEA Water have to meet stricter fertilisation standards and as a consequence show lower nitrate residue levels. Moreover, in all the measurements a significantly decreasing trend is observed over the years, parallel to the evolution of fertilisation standards becoming stricter and farmers adopting more the principles of good fertilisation practices.

References

Statsoft Inc. 2007. Statistica Package 7.1. USA, Tulsa

Farm N balances in European landscapes and the effect of measures to reduce N-losses

Dalgaard, T.^a, Durand, P.^b, Dragosits, U.^c, Hutchings, N.J.^a, Kedziora, A.^d, Bienkowski, J.^d, Frumau, A.^e, Bleeker, A.^e, Magliulo, E.^f, Olesen, J.E.^a, Hansen, B.^g, Thorling, L.^g, Theobald M.R.^h, Drouet J.L.ⁱ, Cellier, P.ⁱ

^aAarhus University, Dept. Agroecology, P.O. Box 50, DK-8830 Tjele, Denmark.

^bINRA-AgroCampus, UMR SAS, Rennes, France.

^cCEH, Penicuik, United Kingdom.

^dRCAFE, Poznan, Poland.

^eECN, Petten, The Netherlands.

^fCNR, Napoli, Italy.

^gGEUS, Geological Survey of Denmark and Greenland, Aarhus, Denmark

^hUPM, Technical University of Madrid, Spain.

ⁱINRA-AgroParisTech, UMR EGC, Thiverval-Grignon, France.

1. Background & Objectives

The farm gate N balance is acknowledged as a valid and reliable indicator for potential nitrogen losses from agricultural systems, and the main driver for N pollution from intensive agricultural landscapes (Dalgaard et al., 2011a). Consequently, to investigate potentials for the reduction of N-losses and greenhouse gas emissions, farm N balances from study landscapes in Denmark, France, Poland, Scotland, The Netherlands and Italy was collected during the www.NitroEurope.eu research project, and the remarkable differences between both the levels of-, and the within landscape heterogeneity were further investigated.

2. Materials & Methods

Farm nitrogen balances were collected from study landscapes in Denmark, France, Poland, Scotland, The Netherlands and Italy in year 2007/2008. Based on the local farm data collections from 265 farms within these landscapes, the farm N-balances were calculated on an annual basis for each farm as the difference between N inputs and N outputs (equation 1).

$$\text{Farm N-surplus} = N_{\text{outputs}} - N_{\text{inputs}} = N_{\text{products}} - N_{\text{feed}} - N_{\text{fertiliser}} - N_{\text{manure}} - N_{\text{fixation}} - N_{\text{deposition}} \quad [1]$$

Moreover for Denmark, additional data sets with farm N balances from farms in year 2002, 1996 and 1990 were included and compared to results from the NitroEurope year 2007/2008 campaign.

3. Results & Discussion

In general the highest N surpluses were found in the French, Italian and the Dutch landscapes (> 150 kg N ha⁻¹ yr⁻¹), whereas the Polish, Danish and Scottish landscapes at average show lower N surpluses (Table 1).

Table 1. Average farm N-balances and 95% confidence intervals for the 6 landscapes 2007/2008 (Preliminary results).

Landscape	N-balance (kg N/ha)	Number of farms sampled
Denmark	101 ± 10	69
Poland	109 ± 22	101
Scotland	119 ± 170	17
The Netherlands	150 ± 20	12
France	163 ± 62	16
Italy	201 ± 22	50

The Danish case study shows significant reductions in farm N surpluses from year 1990 to 2008, and with significantly higher reductions at farms with a high livestock density, compared to farms with a low livestock density (Figure 1). This corresponds to the significant nitrate reductions found in groundwater samples, and reductions in the national farm N surplus in Denmark (Hansen et al., 2011), and the effects of measures to reduce N emissions listed by Kronvang et al. (2008) and Dalgaard et al. (2011b).

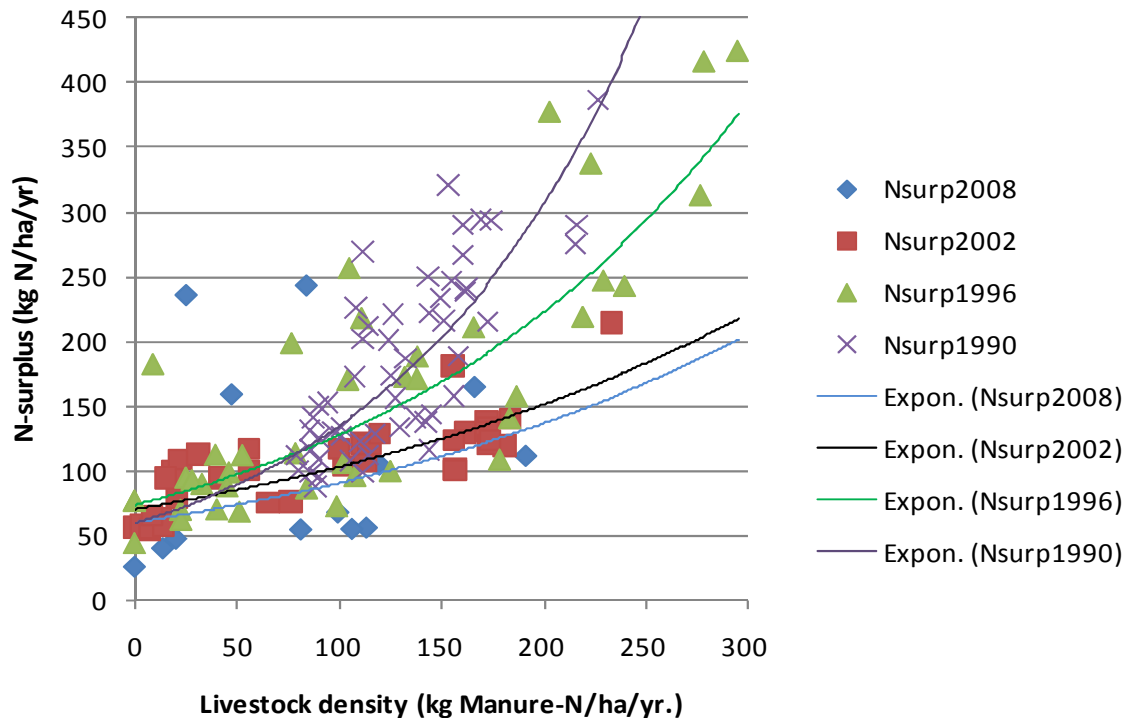

Figure 1. Example on the development in farm N surpluses from Danish farms 1990-2008 (Nsurp), and the related exponential correlations, showing a significantly higher reduction at high compared to low livestock density farms.

4. Conclusion

This work highlights the large variations in farm N surpluses, both between the European landscapes studied, and within these landscapes. Moreover, the large potentials for reductions in the N-losses is discussed, and demonstrated via the Danish case study.

References

- Dalgaard, T., Hutchings, N., Dragosits, U., Olesen, J.E., Kjeldsen, C., Drouet, J.L. and Cellier, P. 2011a. Effects of farm heterogeneity and methods for upscaling on modelled nitrogen losses in agricultural landscapes. *Environmental Pollution* 159 (2011) 3183-3192.
- Dalgaard, T., Olesen, J.E., Petersen, S.O., Petersen, B.M., Jørgensen, U., Kristensen, T., Hutchings, N.J., Gyldenkerne S. and Hermansen, J.E. 2011b. Developments in greenhouse gas emissions and net energy use in Danish agriculture – How to achieve substantial CO₂ reductions? *Environmental Pollution* 159 (2011) 3193-3203.
- Hansen, B., Thorling, L., Dalgaard, T. and Erlandsen, M. 2011. Trend reversal of nitrate in Danish groundwater – a reflection of agricultural practices and nitrogen surpluses since 1950. *Environ Sci and Tech.* 2011, 45 (1) 228–234.
- Kronvang, B., Andersen, H.E., Børgesen, C.D., Dalgaard, T., Larsen, S.E., Bøgestrand, J. and Blicher-Mathiasen, G. 2008. Effects of policy measures implemented in Denmark on nitrogen pollution of the aquatic environment. *Environmental Science and Policy.* Volume 11, Issue 2, Pages 144-152.

Food-based digestate quality and fertiliser value

Rollett, A.J.^a, Taylor, M.J.^a, Tompkins, D.^b and Chambers, B.J.^a

^aADAS Gleadthorpe, Meden Vale, Mansfield, Nottinghamshire, NG20 9PD, UK

^bWRAP, The Old Academy, 21 Horse Fair, Banbury, Oxfordshire, OX16 0AH, UK

1. Background & Objectives

Anaerobic digestion (AD) involves the breakdown of biodegradable materials in the absence of oxygen releasing biogas (a mixture of methane and carbon dioxide) that can be used to provide heat and power, and digestate: a nitrogen-rich fertiliser. AD can help to meet many important environmental goals including the diversion of biodegradable materials from landfill, generation of renewable energy and reduction in climate change gas emissions. However, the agronomic benefits of digestate are less well understood. This project quantified the ‘as produced’ quality of food-based (source-segregated) digestate, providing a robust evidence base to build confidence in its use with farmers and growers.

2. Materials & Methods

Triplicate digestate samples were taken from two food-based AD facilities on two occasions (12 samples in total), following standard methodologies (e.g. Defra/EA, 2009) to obtain representative samples. Both AD facilities were working towards PAS 110 (BSI, 2010), which is an industry specification against which producers can check that digestate is of consistent quality and fit for purpose. Each sample was analysed for a range of nutrients, microbial pathogens, biochemical oxygen demand, physical contaminants, heavy metals and organic compound contaminants.

3. Results & Discussion

3.1. Total and readily available nitrogen

The food-based digestates were shown to be a valuable source of nitrogen (Table 1); the mean total N content was 7.4 kg N m³, compared with ‘typical’ values for pig and cattle slurry of 3.6 kg N m³ and 2.6 kg N m³, respectively (Defra, 2010). The readily available N content (ammonium + nitrate-N) of the food-based digestates was equivalent to c. 80 % of the total N content, compared with c. 70 % and c. 45 % for pig and cattle slurry, respectively. The digestates also contained agronomically useful amounts of phosphate (P₂O₅), potash (K₂O), and sulphur (SO₃) (Table 1).

Table 1. Mean nutrient concentrations in food-based digestate samples compared with ‘typical’ values for pig and cattle slurry (kg/m³ fresh weight)

Nutrient (kg/m ³)	Food-based digestates	Pig slurry*	Cattle slurry*
Dry matter	4.3	4	6
Total N	7.4	3.6	2.6
Readily available N (NH ₄ + NO ₃)	5.9	2.5	1.2
Total P ₂ O ₅	0.5	1.8	1.2
Total K ₂ O	1.8	2.4	3.2
Total SO ₃	0.4	1.0	0.7
Total MgO	0.05	0.7	0.6

*‘Typical’ slurry values taken from the “Fertiliser Manual (RB209)” (Defra, 2010)

3.2. Microbial pathogens

The food-based digestates were PAS 110 compliant for *E. coli* (≤ 1000 colony forming units- CFU/g fresh weight-fw) and *Salmonella* spp. (absent in 25 g of fresh material). By way of comparison, *Salmonella* has been measured in c. 5 % of livestock slurries (Hutchison et al., 2002) and typical *E. coli* numbers in livestock slurries are c. $7 \log_{10}$ CFU/g.

3.3. Biochemical oxygen demand

Biochemical oxygen demand (BOD) is a measure of the oxygen used by microorganisms to decompose organic materials. The mean BOD of the food-based digestates was c. 9,000 mg/l. By way of comparison, pig slurry typically has a BOD of 20,000-30,000 mg L⁻¹, cattle slurry of 10,000-20,000 mg L⁻¹ and 'dirty water' 1,000-5,000 mg L⁻¹ (MAFF, 1998), Figure 1. In common with livestock slurries, food-based digestate has a significant BOD, indicating that care is needed when recycling these materials to land in order to minimise water pollution risks and to maximise their fertiliser value.

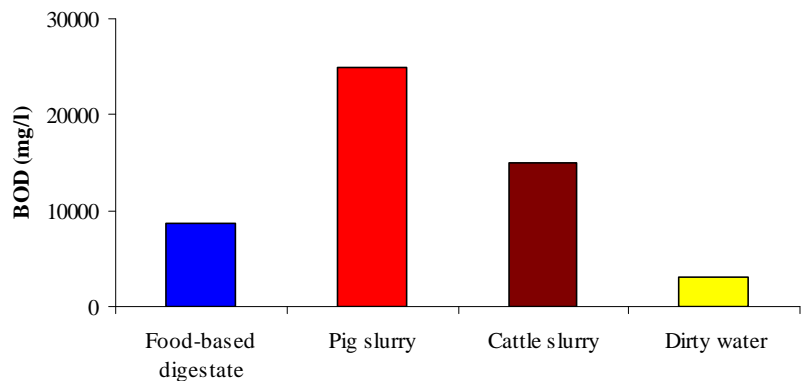

Figure 1. Biochemical oxygen demand (mg/l) of digestate, 'typical' pig and cattle slurries and dirty water (MAFF, 1998).

3.4. Other parameters

Mean heavy metal concentrations in the food-based digestates were within the limits set in PAS 110, with the exception of cadmium in one digestate sample. All of the digestate samples were compliant with PAS 110 limits for physical contaminants (i.e. glass, plastics, etc.). Organic compound contaminants were present only at very low levels or below the limits of analytical detection.

4. Conclusions

The analyses showed that food-based digestates contain valuable quantities of major plant nutrients. In particular, digestate was shown to be a valuable source of readily available N. Careful recycling to land will allow the nutrient value of food-based digestate to be realised, benefitting crop yields and soil fertility and reducing the 'carbon footprint' of farming through savings in manufactured fertiliser use.

References

- BSI, 2010. Publicly Available Specification No 110. Specification for Whole Digestate, Separated Liquor and Separated Fibre Derived from the Anaerobic Digestion of Source-Segregated Biodegradable Materials. BSI, London.
- Defra/EA, 2009. Guidance for Farmers in Nitrate Vulnerable Zones. PB 12736.
- Defra, 2010. Fertiliser Manual (RB209) 8th Edition. The Stationery Office. PB13381
- Hutchison, M.L., Ashmore, A.K., Crookes, K.M., Wilson, D.W., Groves, S.J., Chambers, B.J., Keevil, C.W. and Moore, A. 2002. Enumeration of pathogens in livestock wastes and factors affecting their survival. In: Proceedings of the joint CIWEM and Aqua Enviro Technology Transfer 7th European Biosolids and Organic Residuals Conference MAFF (1998). A Code of Good Agricultural Practice for the Protection of Water. Ministry of Agriculture Fisheries and Food. Publications, London.

Impact of the application of nitrogen from livestock manure on agricultural parcels on water quality: derogation in Flanders

Vandervelpen, D.^a, Maes, S.^a, Tits, M.^a, Elsen, A.^a, Bries J.^a, Vandendriessche, H.^a, Van Overtveld, K.^b, Peeters, L.^b, Batelaan, O.^b, Van Orshoven, J.^b, Vanderborght, J.^b, Diels, J.^b

^aSoil Service of Belgium, Heverlee, Belgium

^bDepartment of Earth and Environmental Science, K.U. Leuven, Belgium

1. Background & Objectives

In the commission decision of 21 December 2007, the Commission of the European Communities approved the Belgian request, with regard to the region of Flanders, to allow a higher application of livestock manure than provided in Nitrogen Directive 91/676/EEC. In this derogation decision a number of specific conditions were imposed on individual farms applying derogation as well on the competent authorities with regard to monitoring, control and reporting. Since nitrogen fertilizers will become more expensive in the future, it is of great importance to verify the possibility of substitution with livestock manure without impact on soil and water quality. The objective of this research is to assess the impact of derogation on nitrogen losses from the soil and on water quality through a monitoring network of at least 150 farms (target of 180 farms and 225 parcels) during 2007-2010.

2. Materials & Methods

The existing monitoring network for phreatic groundwater was chosen as the basis for the set-up of the derogation monitoring network. This groundwater network consists of 2,107 multilevel monitoring wells with short well screens at 3 depths. The wells are equipped with one or more filter elements of 50 cm in length. Preferably, the first two wells were installed in the oxidized zone of the aquifer, where the third well was installed in the deeper reduced zone. For every well the infiltration area and the travel time for water from the root zone to the uppermost well screen was calculated. Only monitoring wells where the infiltration area was completely located in a single agricultural parcel and had a travel time less than 3 years were selected for the derogation monitoring network. In this way the measured water quality in a monitoring well could be linked to the agricultural parcel. Other selection criteria were willingness of farmer to participate, soil type, derogation/non derogation and cultivated crop. One hundred and twenty one parcels linked to monitoring wells were selected, less than the required 225 parcels. Therefore additional parcels were selected from farmers who volunteered to participate in the network and extra monitoring wells were placed to measure the water quality on their parcels. After the selection of parcels several types of measurements were carried out. Each hydrological year a soil sample was taken before and after winter from 0-90 cm in three layers to measure the amount of nitrate in the soil. This gives information on the nitrate residue after harvest and the nitrate leaching out towards the surface and groundwater. To investigate the quality of the surface and groundwater, water samples from the phreatic monitoring wells, the extra monitoring wells, drains, ditches and canals were taken. In order to measure the water quality on parcels with a water level deeper than 1.5 m, a soil sample was taken from 90-120 cm and from 120-150 cm. Besides a general comparison of all derogation and non-derogation parcels, detailed comparisons were carried out for the most common combinations of cultivated crop (grass and maize) and soil type in Flanders (sand and sandy loam). ANOVA tests ($P \leq 0.05$) were carried out to verify statistical differences of measured nutrients between derogation and non-derogation parcels.

3. Results & Discussion

Differences in nutrient levels in the soil profile were present among different cultivated crops and soil types but less between derogation and non-derogation parcels. No statistically significant differences were found between derogation and non-derogation parcels for nitrate in the soil profile (0-90 cm) at none of the sampling moments. Table 1 shows the nitrate results from the most common combinations (sand/sandy loam, grass/maize).

Table 1. Summary of nitrate-N (kg ha^{-1}) in the soil profile (0 to 90 cm) at different moments for the most important combinations of soil type and cultivated crop for derogation and non-derogation parcels.

Date		Crop	Derogation	Non-derogation	Significance*
Nov 2009	Sand	Grass	57(\pm 42)	51 (\pm 36)	n.s.
		Maize	109 (\pm 49)	93 (\pm 33)	n.s.
	Sandy loam	Grass	68 (\pm 34)	85 (\pm 39)	n.s.
		Maize	80 (\pm 30)	77 (\pm 36)	n.s.
Feb 2010	Sand	Grass	38 (\pm 22)	40 (\pm 25)	n.s.
		Maize	44 (\pm 25)	44 (\pm 15)	n.s.
	Sandy loam	Grass	45 (\pm 30)	49 (\pm 16)	n.s.
		Maize	38 (\pm 16)	37 (\pm 16)	n.s.
Nov 2010	Sand	Grass	47 (\pm 42)	39 (\pm 31)	n.s.
		Maize	77 (\pm 43)	78 (\pm 50)	n.s.
	Sandy loam	Grass	41 (\pm 24)	66 (\pm 64)	n.s.
		Maize	74 (\pm 45)	70 (\pm 37)	n.s.
Feb 2011	Sand	Grass	33 (\pm 15)	46 (\pm 21)	n.s.
		Maize	40 (\pm 12)	45 (\pm 22)	n.s.
	Sandy loam	Grass	38 (\pm 24)	36 (\pm 18)	n.s.
		Maize	43 (\pm 16)	44 (\pm 12)	n.s.

*n.s. indicates no statistically significant difference for the ANOVA test ($P \leq 0.05$).

No statistically significant differences were observed between derogation and non-derogation parcels for the concentrations of nitrate in drains, canals and ditches. In the sampling points (phreatic monitoring wells and extra monitoring wells, Table 2) and in soil water (90-120 cm, Table 3) no statistically significant difference was present between derogation and non-derogation parcels.

Table 2. Average value for nitrate ($\text{mg NO}_3 \text{ L}^{-1}$) of sampling points linked to parcels for all crops and soil types.

Date	N	Derogation	n	Non-derogation	Significance*
2008	47	25 (\pm 47)	66	29 (\pm 45)	n.s.
2009	40	31 (\pm 54)	25	20 (\pm 41)	n.s.

*n.s. indicates no statistically significant difference for the ANOVA test ($P \leq 0.05$).

Table 3. Average value for nitrate ($\text{mg NO}_3 \text{ L}^{-1}$) in pore water in the soil layer 90-120cm for all crops and soil types.

Date	Derogation	Non-derogation	Significance*
November 2009	77 (\pm 58)	95 (\pm 101)	n.s.
February 2010	64 (\pm 56)	92 (\pm 77)	n.s.
November 2010	64 (\pm 63)	77 (\pm 113)	n.s.
February 2011	48 (\pm 37)	76 (\pm 72)	n.s.

*n.s. indicates no statistically significant difference for the ANOVA test ($P \leq 0.05$).

4. Conclusion

Based on the extensive information of the monitoring network it is possible to conclude that application under specific derogation conditions of more nitrogen originating from livestock manure than described in Nitrogen Directive 91/676/EEC has no significant negative impact on water quality in Flanders, regarding nitrate concentration.

Impact of timing of nitrogen fertilization at tillering stage on rice plant growth in intermittent water management.

Martínez-Eixarch, M.^{a,b}, Català-Forner, M.M.^a, Pla-Mayor, E.^a, Tomàs-Navarro, N.^a, Zhu D.^c

^aIRTA (Institute for Food and Agricultural Research and Technology). Ctra. Balada, km 1. 43870. Amposta. Spain

^b Present address: Department of Agriculture, University of Reading, Earley Gate, Reading RG6 6AR, UK

^c CNRRI (China National Rice Research Institute). 359 Tiyuchang Road, Hanzhou 310006, Zhejiang, China

1. Background & Objectives

Tillering is a key process within the rice plant growth cycle as it plays an important role in determining the panicle number (Gendua et al., 2009). Nitrogen (N) fertilization is an important factor in rice tillering because it promotes the emergence of the culms and enhances their productivity. Nitrogen efficiency could be improved by a more precise application of the fertiliser. In the Mediterranean climate, water scarcity is predicted under a scenario of climatic change (Climate Change 2001: Impacts, Adaptation and Vulnerability - IPCC, 2001). In rice, the intermittent water management system has been presented as a promising water saving irrigation system. The aim of this study was to investigate whether early N fertilisation at tillering stage would increase the yield in rice plants by promoting tillering in lower nodes. Also, the effect of a water-saving management and its interaction with the N fertilisation was considered.

2. Materials & Methods

In 2008, a field experiment was conducted in Ebro Delta area (Southern Catalonia, Spain) under direct sown system cultivation. The N treatments focused on the timing of application during the tillering stage: either early tillering fertilization at the 3.5-leaf stage (N4L) or late tillering fertilization at the 8.5-leaf stage (N8L). The same dose of N (120 kg ha⁻¹) was used in both treatments. In addition, two water management systems were compared: a standard water management (SWM) system with continuous flooding at 7 cm deep, which is usually practiced in the area, and an alternate wetting and drying (AWD) system with layers of 3 cm deep. The experiment was analyzed as a randomized plot design with 3 replications. Cultivar used was Gleva, which is widely grown in Ebro Delta area. Tiller emergence and survival of primary nodes (emerging from buds on the main stem) were monitored in 10 plants per treatment with three replicates. At harvest, grains in each tiller were oven-dried at 80°C for 3 days and then weighed. Plant and tiller yield were assessed by the dry weight of the grains on a panicle basis. The plant yield was the sum of tiller yield. Analysis of variance was made using the MIXED and ANOVA procedures and mean separation tests were performed using the adjusted Tukey's least significant difference test (LSD). The statistical program used was SAS version 9.2.

3. Results & Discussion

The early N fertilisation at tillering stage promoted the emergence of tillers in plants (54.7% and 49.7% in N4L and N8L, respectively, $P=0.06$), especially in lower positions. The average dry grain yield in the primary panicles was significantly higher in N4L (1.84±0.42 g) than in N8L (1.53±0.50 g) ($P=0.0005$). As a result, the yield of plants under N4L was higher (5.8±1.4 g) than under later N fertilisation (4.5±1.4 g) with a probability near the 5% significance level ($P=0.08$). The interaction between N fertilisation and water management was significant for tiller emergence ($P=0.022$) and tiller survival ($P=0.03$).

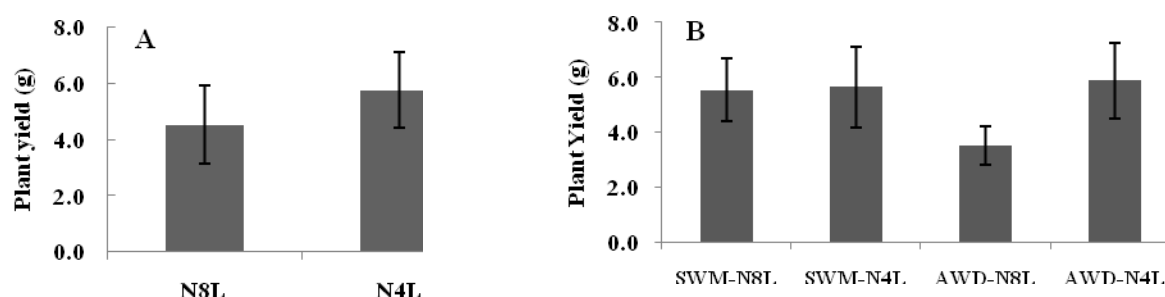

Figure 1. Response of plant yield in the different nitrogen treatments (A) and combinations of nitrogen and water treatments (B). **A.** N fertilization at the start of tillering (N4L) promoted higher yields than fertilization at mid or late tillering (N8L). **B.** Plants under the treatment AWD-N8L yielded markedly less due to the poorer tillering and the subsequent lower panicle number. [SWM, standard water management (7-cm water layer); AWD, alternating wetting and drying; N4L, N fertilization at plant stage of 3.5 leaves; N8L, N fertilization at plant stage of 8.5 leaves].

Plants subjected to intermittent water management (AWD) and late N fertilisation (N8L) had 15 and 35% lower ratios of tiller emergence and tiller survival, respectively. No response to N fertilisation was observed in plants grown under SWM. Overall, the impact of AWD-N8L resulted in a lower panicle number per plant and the subsequent decline in plant yield (Fig. 1B), although not significantly likely due to the variability observed. The reduced panicle number and yield of the AWD-N8L treatment could be a response to a N shortage caused by the added effect of 1) a loss of N through denitrification due to the watering system (Sah et al., 1083) and 2) the lack of N supply in early plant development (Pham Quang et al., 2004). However, our results indicated that these negative effects could be overcome by improving the precision of N through earlier N fertilisation. By doing so, a good adjustment between plant N demand and N availability could be achieved leading to an improvement in the fertilisation efficiency under AWD irrigation system.

4. Conclusion

Nitrogen fertilisation at the beginning of the tillering stage increased tiller emergence and promoted the development of lower nodes. There was a trend for yield to increase under these conditions. In addition, there was a significant interaction between timing of N fertilisation and the irrigation system; the intermittent water management and N fertilisation at mid-late tillering reduced the emergence and survival of tillers resulting in a decline in plant yield. This performance should be considered for the use of water saving technologies.

References

- Gendua, P.A., Yamamoto, Y., Miyazaki, A., Yoshida, T. and Wang, Y.L., 2009. Effects of the Tillering Nodes on the Main Stem of a Chinese Large-Panicle-Type Rice Cultivar, Yangdao 4, on the Growth and Yield-Related Characteristics in Relation to Cropping Season. *Plant Production Science* 12, 257-266.
- IPCC, 2001. Working Group II: Impacts, Adaptation and Vulnerability – Contribution of the Working Group II to the Third Assessment Report of the Intergovernmental Panel on Climate Change.
- Pham Quang, D., Mitsugu, H., Satoru, S. and Eiki, K., 2004. Varietal differences in tillering and yield responses of rice plants to nitrogen-free basal dressing accompanied with sparse planting density in the Tohoku region of Japa. *Plant Production Science* 7, 3-10.
- Sah, R, Mikkelsen, D., 1983. Availability and utilization of fertilizer nitrogen by rice under alternate flooding. *Plant Soil*, 75, 227-234
- Zeng, L.H., Lesch, S.M. and Grieve, C.M., 2003. Rice growth and yield respond to changes in water depth and salinity stress. *Agricultural Water Management* 59, 67-75.

Improvement of sensor based N application approach in winter wheat by incorporation of soil and terrain properties

Samborski, S.^a, Dobers, E.S.^b, Gozdowski D.^c, Stepień M.^a

^a Department of Agronomy, Warsaw University of Life Sciences, Poland

^b Ag-GeoData, Göttingen, Germany

^c Department of Experimental Design and Bioinformatics, Warsaw University of Life Sciences, Poland

1. Background & Objectives

Optical sensors estimate different crop properties among them N status and biomass. Therefore, sensor based nitrogen (N) applications have been used in different crops, including winter wheat, to optimize variable N fertilization on fields with varying growing conditions. N rate applied at the beginning of the booting stage is very important for grain yield formation of winter wheat. But at this growth stage plants may not show yet their yield potential expressed as a vegetation index (VI) for different sites, due to the lack of water deficit symptoms at this time. As a consequence an optical sensor will be able to discriminate canopy variability *in situ* but it may not be able to make appropriate corrections for lower yield potential in less productive parts of the field, which will appear later in time. To overcome these limitations the use of a map overlay approach for more precise N fertilization seems to be relevant. Integration of information on soil quality (Holland and Schepers, 2010) and field topography (Soil Fertility Manual, 2006) may improve N fertilization algorithms. The aim of this study was to propose for future testing an approach for reduced use of N fertilisers in less responsive zones reasoned by suboptimal conditions for N uptake (Nupt).

2. Materials & Methods

The research was conducted in the season 2009/2010 in northern Poland (54° 31' N 17° 18' E) on a field cropped with winter wheat (*Triticum aestivum* L.) and farmed by Farm Frites Poland Dwa Sp. z o.o. The field under study (ca. 30ha) is dominated by Dystric Cambisols (WRB, 2006) with predominantly sandy loam texture developed from glacial moraine deposits of the last glaciation.

As 1st N application at growth stage (GS) 22 (Zadoks et al., 1974) the field received a uniform N rate of 80 kg ha⁻¹ as urea ammonium nitrate solution (UAN) with 32% N. For the 2nd (GS 32) N application, the field was divided into tramline wide strips, fertilized alternatively with a variable or uniform N dose of ammonium nitrate (34%). For variable N application two Crop CircleTM ACS-210 sensors (Holland Scientific, Lincoln, NE) were used. Reflection data was used for the calculation of the Green Normalized Difference Vegetation Index (GNDVI, Dellinger et al., 2008). Data on the relationship GNDVI and Green Area Index (GAI), N uptake per unit GAI, established on a N-response experiment adjacent to the study field were used to calculate variable N rate.

Grain yield was measured at harvest time by yield monitors with DGPS data logging. Nitrogen surplus or deficit for the whole research field was calculated as the difference between total N applied and total N uptake, estimated from yield data. The relationship between grain yield vs. N uptake was determined for whole plant samples collected over the entire area of the research field.

Agricultural soil map information was used to derive the data on the variability of the soil's potential productivity (SPP). This map covered three agricultural suitability complexes (ASC) numbered 2, 4 and 5 with the SPP respectively of 100%; 82.7% and 65.4%. The SPP calculation was based on the same relation of winter wheat grain yields obtained on the same complexes in field experiments carried out in Poland in the 70' and 80' of the 20th century (Woch et al., 2006).

Elevation data from tractor mounted RTK-dGPS measurements registered during tillage operations, were used for the calculation of terrain slope. In previous analyses we found that an increase in slope of 1 degree reduced the total N uptake by 4.75 kg ha⁻¹. Therefore, similar reduction in total N

applied, but corrected by the share of the 2nd dressing in total N applied of 36% was proposed. After this correction the reduction in N rate per 1 degree of slope rise was 1.71 kg N ha⁻¹.

3. Results & Discussion

The southern part of the field showed the highest N surplus independently from the N application strategy (Figure 1a). This suggests that the cause of N surplus has to be related to some other factors, not yet incorporated in the map overlay and a sensor based N application algorithm. Soil map data (Figure 1a) and slope maps superimposed on the N surplus/deficit areas indicate that the southern part of the field is characterized by coarser soil (ASC 4 and 5) and steeper, eroded slopes (data not shown). This resulted in lower SPP thus decreased N uptake, not exceeding the amount of total N applied and consequently higher N surplus. The use of a sensor alone at GS 32 for VRA does not allow to reduce N rate in areas with lower SPP (Figure 1b). This is because the default strategy for control of N rate by crop reflectance is to apply more N on poor areas to maintain tillers and grain numbers. In our simulation study to limit N oversupply on less productive southern part of the field the information provided by the soil and terrain slope maps has been incorporated in the calculation of the variable N rate. Figure 1c presents the map of N applied where the information from the sensor, soil and terrain slope maps has been combined. Incorporation of soil map and topography data would help to reduce average variable N rate used at GS32 respectively by 2.5 (range 0-23.5) and 2,4 (range 0-20.5), kg ha⁻¹ in comparison to the average amount of N applied when only sensor information was used.

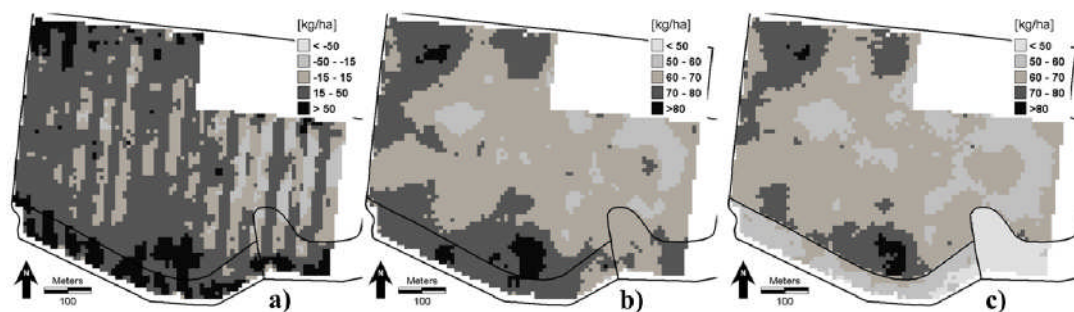

Figure 1. Maps of: a) N surplus or deficit, b) N application sensor based, c) N application sensor, soil and slope based.

4. Conclusions

This novel approach of incorporating soil and terrain properties into calculation of variable N rate improves the sensor based N application alone by applying less N in the potentially less responsive zones. The next step in the improvement of the N application algorithm should be testing if reduced use of N fertilisers, based on the soil map and topography data in the potentially less responsive zones, do not cause significant yield decrease.

References

- Dellinger, A.E., Schmidt, J.P. and Beegle, D.B. 2008. Developing Nitrogen Fertilizer Recommendations for Corn Using an Active Sensor. *Agronomy Journal* 100, 1546-1552.
- Holland, K.H. and Schepers, J.S. 2010. Derivation of a Variable Rate Nitrogen Application Model for In-Season fertilization of Corn. *Agronomy Journal* 102, 1415-1424.
- WRB. 2006. World Reference Base for Soil Resources 2006. FAO, Rome.
- Soil Fertility Manual 2006. International Plant Nutrition Institute.
- Woch, F. (ed.) 2006. Wademekum klasyfikatora gleb. IUNG-PIB Puławy pp. 376.

Influence of agricultural practices and climate changes in Portuguese rice production

Figueiredo, N.^a, Carranca, C.^{a*}, Trindade, H.^b, Pereira, J.^b, Prazeres, A.^a, Mano, R.^c, Marques, P.^d, Vargues, A.^a

^aINIA, Quinta do Marquês, Nova Oeiras, 2784-505 Oeiras, Portugal

^{a*}Corresponding author: INIA, Qta. Marquês, Nova Oeiras, 2784-505 Oeiras; CEER, ISA/UTL, Portugal
Tel. +351 214403517, Fax. +351 214416011, e.mail: c.carranca.ean@clix.pt

^bCITAB, UTAD, Vila Real, Portugal

^cINIA, Tapada da Ajuda, Lisboa, Portugal

^dCOTArroz, Paúl de Magos, Salvaterra de Magos, 2120-014 Salvaterra de Magos, Portugal

1. Background & Objectives

Rice is one of the most important food crops in the world and the staple for more than half of the global population. Portugal is the first rice consumer, *per capita*, in Europe and the fourth producer (6 t ha⁻¹), contributing to the 5.3% of the total European production. Rice cultivation in Portugal is intensive and is mostly located in the central and southern regions (Mondego, Tagus and Sado Valleys). The cultivation in Europe is mainly by flooding to control soil temperature, weeds and pests. The water content of soils can vary considerably, depending on climatic conditions, soil type and agricultural practices. In Portugal, rice straw is returned to the field after harvest, partially is burnt and partly is incorporated preceding the rice cultivation. Straw incorporation in soil in the non-rice-growing season can result in lower methane emission in the following rice-growing season than does the incorporation just before rice cultivation. The anaerobic conditions in flooded soils influence nitrogen (N) fertilizers dynamics, particularly the redox potential and soil pH. Rice roots absorb nitrate (NO₃⁻) or ammonium (NH₄⁺) from soil using a variety of transporters, but NH₄⁺ is the preferential form in waterlogged soils. Nitrogen use efficiency is generally low (20-35%).

In 2011, we evaluated the soil and floodwater N and pH dynamics, and the rice response to the actual agricultural practices in an open field at Salvaterra de Magos (central Portugal), and in open top chambers with increased atmospheric carbon dioxide concentration [CO₂] and temperature.

2. Materials & Methods

In 2011, a field experiment was established in Salvaterra de Magos (central Portugal) with waterlogged rice (*Oryza sativa* L. 'Ariete') sown in May. A randomized block design with three replications was used to evaluate the soil and floodwater N and pH dynamics and crop response to the actual agricultural practices and to the double atmospheric [CO₂] (560 ppm), and temperature increase. Six open top chambers (4 m wide x 3 m height x 2 m open top Ø) were installed, three for CO₂ and three for temperature. The clay soil had a pH 4.7. The dominant clay minerals were illites>smectites. Irrigation water had a pH 7.9, a low electric conductivity (0.5 mS cm⁻¹) and NH₄⁺ content (0.2 mg NH₄⁺-N l⁻¹), a medium level of NO₃⁻ (5 mg NO₃⁻-N l⁻¹) and a high amount of chloride (71 mg Cl⁻ l⁻¹) content. 'Ariete' is a moderate resistant cultivar to the Cl⁻ toxicity. Mean air temperature during the growth cycle in the field varied from 12 °C in March to 20 °C in August. Rainfall only occurred in June (25 mm) and October (230 mm). The wind speed was 3.8 - 8.1 m s⁻¹. Nitrogen fertilizers in the NH₄⁺ and ureic forms were split twice as basal and top dressing (50 and 40 kg N ha⁻¹, respectively). Inorganic-N and pH were frequently determined in soil and floodwater during the crop growth and for each treatment, and SPAD-measurements were taken in young Y-rice leaf at each 2-3-week interval, in each plot. Results were analyzed using Main-Effects ANOVA (for floodwater composition) and General Linear Model for soil and plant.

3. Results & Discussion

The floodwater above the soil surface did not show significant variations during the season as to inorganic-N content ($1.61 \text{ mg NH}_4^+\text{-N l}^{-1}$ and $0.99 \text{ mg NO}_3^-\text{-N l}^{-1}$) and pH (8.01). Soil pH increased with flooding but did not differ significantly with treatments. A slightly greater value was measured in CO_2 chambers (pH 7.5) compared to pH 6.0 in other situations. The soil pH did not vary significantly along the vegetative growth and with depth, although a pH 7.5 was observed at surface, decreasing to pH 6.0 downwards. Soil inorganic-N varied significantly during the growth cycle. Ammonium was significantly higher in the open field (especially at the end of the season) and temperature chamber (average: $3.2 \text{ mg NH}_4^+\text{-N kg}^{-1}$), but did not vary with soil depth ($2.7 \text{ mg NH}_4^+\text{-N kg}^{-1}$). The interaction date vs. depth affected significantly the cation content (Fig. 1a). Nitrate decreased significantly in the soil profile, with a greater value at 0-20 cm ($1.33 \text{ mg NO}_3^-\text{-N kg}^{-1}$), but did not vary with treatments ($0.79 \text{ mg NO}_3^-\text{-N kg}^{-1}$). The interaction date vs. depth was significant (Fig. 1b), and the highest value was obtained in the top layer after the basal dressing.

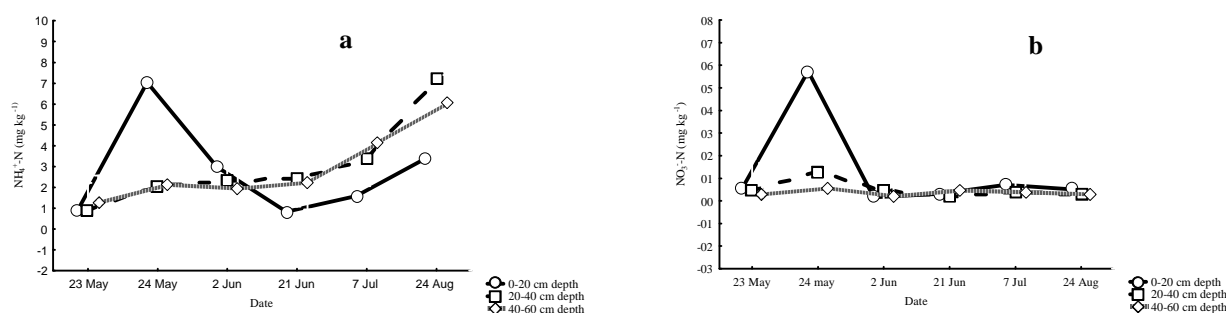

Figure 1. Interaction of date vs. depth effects on soil $\text{NH}_4^+\text{-N}$ (a) and $\text{NO}_3^-\text{-N}$ (b) during the rice season, in 2011.

SPAD-readings in 'Ariete' rice Y-leaf in the open field were significantly smaller (38) than values obtained in plants cropped in CO_2 and temperature chambers (41). SPAD-values above 35, i.e., greater than 1.4 g N m^{-2} leaf area indicate a proper crop N status (Figueiredo, 2011).

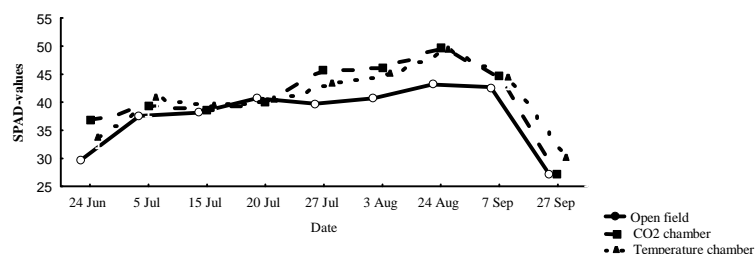

Figure 2. Interaction of date vs. treatment effect on SPAD-values in Y-leaf of 'Ariete' rice, during 2011 growth.

4. Conclusions

Ammonium increased in the soil profile after flowering stage, but NO_3^- was maintained low. Flooding increased the soil pH (from 4.7 to about 6) and was apparently higher in CO_2 chambers (7.5). Rice 'Ariete' showed a proper N status for the whole season, but a significantly higher crop N was measured inside the open top chambers (SPAD-readings: 38-41). Measurements on gaseous losses and NH_4^+ -fixation in soil are recommended to evaluate the fertilizer-N efficiency.

Reference

Figueiredo, N. 2011. Dinâmica do Azoto em Campos Alagados para Produção de Arroz, em Salvaterra de Magos. Thesis for Master degree in Agricultural Engineering, ISA/UTL, Lisbon. p. 60.

Influence of inter tillage on nitrate content in soil during tobacco crop growth

Castelli F.^a, Marchetti R.^b, Orsi A.^b, Sghedoni L.^b

^aAgricultural Research Council, Bovolone Experimental Farm, Bovolone (VR), Italy

^bAgricultural Research Council, Research unit for swine husbandry, San Cesario sul Panaro (MO), Italy

1. Background & Objectives

With the establishment of the Common Agricultural Policy (CAP), the EU subsidies to farmers are linked to their compliance with rules relating to agricultural land, agricultural production and activity. Given the high environmental impact of tobacco crop, requiring the use of large amounts of chemicals, it could be possible to provide assistance to farmers who undertake the implementation of cropping practices capable of reducing the environmental impact of tobacco cultivation. In a previous experiment we detected unusually high amounts of inorganic N in the top soil cropped with Virginia Bright tobacco (*Nicotiana tabacum* L.), in the early stages of the growth season (Marchetti et al., 2006). Nitrogen excess affects negatively tobacco leaf quality and can give rise to water pollution by nitrates. Tobacco, being a row crop, needs some tillage operations (ST) during the crop cycle (usually reported as “inter tillage”) to reduce weed growth, improve soil aeration and water infiltration, and prepare row ridges. As tillage is known to trigger N mineralization (Dinnes et al., 2002), we hypothesized that ST operations, by aerating the soil, could foster the organic-N mineralization, and consequently cause an increase in the soil nitrate N levels.

2. Materials & Methods

A field experiment was carried out in 2007, 2008 and 2010 at Bovolone, near Verona, Italy, on a loam soil, cropped with Virginia Bright tobacco, cv. K 326. The compared treatments were: 2 tillage intensity levels (in-row cultivation + ridging, ST, vs. non tilled soil, NT) × 2 fertilizer N rates 0 (N0) and 80 (N80) kg N ha⁻¹. The experimental design was a split-plot, with the tillage level factor in the main plot, and the N rate factor in the sub-plots (256 m²), with 3 replications. Nitrogen fertilizer was applied as calcium nitrate at the beginning of June, a month after tobacco transplanting. In-row cultivation and ridging was carried out in June. Tobacco leaf yield was determined as the sum of yields at 3 priming dates. Leaf yield and aboveground biomass were obtained from 20 plant samples per plot. Crop N (Kjeldahl method) removal was calculated on the basis of plant dry matter and N concentration in the plant tissues. The nitrate-N content in soil (NO₃-N) was determined colorimetrically with an automatic analyzer in samples from the top 0–0.20 m layer, in the June–July period, on 6 dates, including before and after the ST operations. A mixed model was used for the statistical analysis of leaf yield, crop N removal and NO₃-N content in soil. In this paper, means of 3-year measurements are reported. Multiple comparisons of the means were carried out. Factor effects were considered significant at $P < 0.05$.

3. Results & Discussion

Tobacco-leaf yield in the tilled plots was slightly higher than in the non tilled (4.9 vs. 4.6 t ha⁻¹; Figure 1). Nitrogen fertilization (N80) increased leaf yields approximately by 1 t ha⁻¹, compared with the N0 rate (5.3 and 4.2 t ha⁻¹, respectively). The amount of N removed by the aboveground biomass (AGB) was remarkably higher in plots supplied with N fertilizer (+65%, compared with N0). Differences due to N fertilization were still more emphasized in the case of the nitrate-N amount measured in the plant tissues (+274%, compared with N0). High nitrate-N contents in tobacco leaves following N fertilization had already been observed in previous tobacco experiments

(Castelli et al., 2011). Nitrates are considered dangerous as precursors of carcinogenic nitrosamines. No significant differences between treatments were associated with tillage intensity.

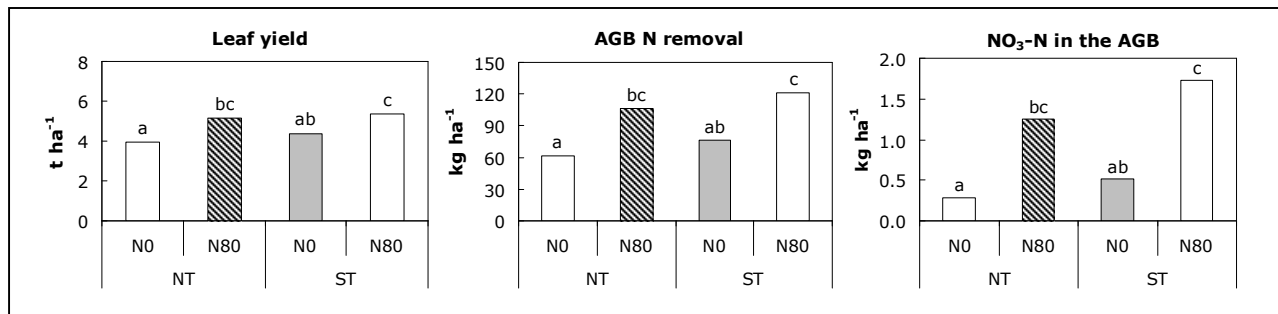

Figure 1. Influence of tillage intensity level (inter tillage, ST, vs. no tillage, NT) and fertilizer N rate (non fertilized crop, N0, vs. fertilized, N80) on tobacco leaf yield, N removal in the above ground biomass (AGB) and NO₃-N content in the AGB. Means followed by the same letters are not significantly different for $P < 0.05$ probability level.

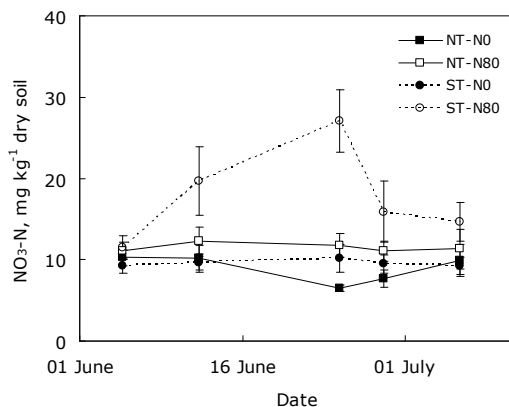

Figure 2. Nitrate-N (NO₃-N) content in the top 0–0.20 m soil layer during the tobacco growth season. The error bars indicate the SE for the interaction effect between tillage treatments and fertilizer N rate.

Nitrogen fertilization gave rise to an increase in the nitrate-N content in soil during the crop growth season (Figure 2). This increase was much more evident in the ST than in the NT plots. Alvarez and Steinbach (2009) studied tillage effect on inorganic N availability in soil and found that, when nitrate-N level in soil was low, differences between tillage and limited tillage systems were also low and increased as nitrate N level rose.

4. Conclusion

An important positive interaction effect on soil nitrate levels was observed between N fertilizer and inter tillage; specifically, soil nitrate levels were much higher in the soil of tilled and fertilized plots. Crop fertilization with 80 kg N ha⁻¹ positively influenced tobacco leaf yields, whereas inter tillage did not. In other words inter tillage, coupled with N fertilization, did not lead to increased crop yields, but instead increased tobacco leaf- and soil nitrate content, which is detrimental for the technological quality of tobacco leaves, as well as for the quality of the environment. As tobacco needs inter tillage for weed control and plant ridging, it is important to take into account the effect of inter tillage on soil N availability by properly reducing the fertilizer N supply to tobacco crop.

References

- Alvarez, R. and Steinbach, H.S. 2009. A review of the effects of tillage systems on some soil physical properties, water content, nitrate availability and crops yield in the Argentine Pampas, *Soil and Tillage Research* 104, 1-15.
- Castelli, F., Ceotto, E. and Contillo, R. 2011. Reduced N supply limits the nitrate content of flue-cured tobacco, *Agronomy for Sustainable Development* 31(2), 329-335.
- Dinnes D.L. et al. 2002. Nitrogen management strategies to reduce nitrate leaching in tile-drained mid-western soils, *Agronomy Journal* 94, 153–171.
- Marchetti, R., Castelli, F. and Contillo, R. 2006. Nitrogen requirements for flue-cured tobacco, *Agronomy J.* 98, 666-674.

Irrigation and nitrogen fertiliser management effects on nitrate leaching losses from crop rotations

Thomas, S.M.^a, Francis, G.S.^b, Waterland, H.E.^a, Zyskowski, R.F.^a, Tabley, F.J.^a, Gillespie, R.N.^a, Sharp, J.M.^a, Fraser, P.M.^a

^aNew Zealand Institute for Plant & Food Research Limited, Private Bag 4704, Christchurch, New Zealand.

^bAgResearch, Private Bag 4749, Christchurch, New Zealand

1. Background & Objectives

The effects of land use change and intensification on groundwater contamination by leached nitrate (NO₃) are of international concern. Both farmers and policy makers need tools to predict the effects of land management decisions on groundwater quality. However, there is a lack of appropriate tools available to these users. In New Zealand there are also few data available to validate predicted NO₃ leaching losses from crops and most of these data are from studies where only winter measurements have been made. However, the increasing use of irrigation and large fertiliser inputs for growing high value crops increases the likelihood of leaching losses during other seasons. The objectives of this three-year field study were to (i) quantify how NO₃ leaching losses were affected by different nitrogen and irrigation management for two cropping rotations and (ii) provide data to validate components of the APSIM (Agricultural Production Systems Simulator) model (Keating et al., 2003).

2. Materials & Methods

A field experiment was established in spring 2004 at Lincoln, Canterbury, New Zealand on a moderately well drained, intensively cropped soil (Udic Ustochrept; USDA Soil Taxonomy) with two crop rotations ([i] potatoes – winter wheat – winter fallow – potatoes - triticale, and [ii] potatoes – winter fallow - spring sown peas – winter fallow – potatoes - triticale). The experiment was a randomised block design with eight replicates (each plot was 17 m long, 4.56 m wide). Each crop received three different rates of nitrogen fertiliser (N0, N1, N2) and two rates of irrigation (W1, W2) with the exception of the triticale crop that received no N fertiliser and the same irrigation treatment. Winter fallow had no crop cover. For each crop, N1 and W1 represented the optimum rates of fertiliser and irrigation. Solution samplers were installed in each plot (60 cm in the first potato crop; 150 cm in subsequent crops and fallow periods). Soil mineral N (0-150 cm) was measured in spring and autumn. Nitrate leaching losses were calculated from soil solution NO₃ concentrations and drainage calculated from a soil water balance model.

3. Results & Discussion

Nitrate leaching losses varied considerably in response to the irrigation and fertiliser treatments, crop rotation and winter rainfall (Table 1). Greatest leaching losses (109 kg N ha⁻¹) were measured from potato plots with both excess irrigation and N fertiliser (W2N2), and over the wet winter fallow period in 2006 (275 mm drainage), especially following the pea crop (49 to 99 kg N ha⁻¹). Although there was a fallow period in 2005, the lowest leaching losses (3 to 9 kg N ha⁻¹ in about 40 mm of drainage) were measured due to low autumn and winter rainfall; winter drainage of 100 to 150 mm is typical. Nitrate leaching losses from the N1 and N2 plots of the second potato crop were much lower when irrigation was applied at amounts to maintain a soil water deficit compared to strategies to refill the soil profile (66 to 82% lower). The amount of NO₃ leached from the autumn sown triticale crop (without N fertiliser applied) was also affected by the N fertiliser management of the previous potato crop; leaching losses from the N2 treatment (39 kg N ha⁻¹) were almost twice those of the N1 treatment (22 kg N ha⁻¹).

Table 1. Nitrate leaching losses from two cropping rotations with different irrigation (W1 and W2) and N fertiliser (N0, N1 and N2) management.

		Nitrate leaching losses kg N ha ⁻¹				
		Oct 2004- Apr 2005	Apr 2005- Mar 2006	Mar 2006- Oct 2006	Oct 2006- Apr 2007	Apr 2007- Sep 2007
Rotation 1		Potatoes	Fallow-Peas	Fallow	Potatoes	Triticale
W1	N0	8.7	3.2	49.4	12.6	15.4
	N1	45.8	3.3	55.1	15.2	22.8
	N2	68.2	5.8	99.2	18.8	39
W2	N0	22.6	2.6	36.2	8.7	12.9
	N1	62.1	3.8	49.7	10.9	21.8
	N2	108.5	7.9	58.1	12.5	38.6
Rotation 2		Potatoes ¹	Wheat	Fallow	Potatoes ²	Triticale ²
W1	N0	8.7	2.8	23.6	12.6	15.4
	N1	45.8	4.2	30.4	15.2	22.8
	N2	68.2	4.4	62	18.8	39.4
W2	N0	22.6	3.3	25.8	8.7	12.9
	N1	62.1	5	35.4	10.9	21.8
	N2	108.5	8.6	66.2	12.5	38.6
LSD (<0.05) within rotation		17.3	2.9	11.42	3	8
LSD (<0.05) between rotations		17.3	2.9	16.3	3.6	10.93

¹Only rotation 1 was measured.

²Following winter leaching losses, the amounts of mineral N were low and did not differ between the rotations; only Rotation 1 plots were measured.

4. Conclusion

This work highlights the importance of (i) efficiently managing both irrigation and fertiliser N to minimise drainage and leaching losses, and (ii) planting autumn sown crops to minimise the risk of NO₃ leaching over winter. This crop rotation field experiment has provided an important dataset to validate and test simulation models (e.g. APSIM) for a range of crops, water and nitrogen management conditions. The range of leaching losses under different managements also highlights the need for the development of model-based tools that farmer and policy makers can use to manage land use, and enable or limit intensification to levels that do not adversely impact the environment.

References

Keating B.A., Carberry P.S., Hammer G.L., Probert M.E., Robertson M.J., Holzworth D., Huth N.I., Hargreaves J.N.G., Meinke H., Hochman Z., McLean G., Verburg K., Snow V., Dimes J.P., Silburn M., Wang E., Brown S., Bristow K.L., Asseng S., Chapman S., McCown R.L., Freebairn D.M. and Smith C.J. 2003. An overview of APSIM, a model designed for farming systems simulation. *European Journal of Agronomy* 18, 267-288.

Mitigating ammonia emissions from stored dairy cow manure.

van der Weerden, T.J.^a, Luo, J.^b, Dexter, M.^b

^aAgResearch, Invermay Agricultural Centre, Mosgiel, New Zealand

^bAgResearch, Ruakura Agricultural Centre, Hamilton, New Zealand

1. Background & Objectives

In many parts of New Zealand (esp. Canterbury southwards), dairy cows are typically wintered on annual forage crops such as kale and swedes. This practice can result in significant nutrient and faecal contaminant losses to waterways, while animal treading damage can also impact on soil quality and crop utilisation. Some farmers are considering moving away from year-round grazing to instead adopt Northern Hemisphere-style housing systems, particularly over these wet winter periods. While avoiding winter grazing can reduce nitrate leaching and nitrous oxide (N₂O) emissions from such soils, these systems are relatively new to New Zealand with little information on gaseous losses to determine the risk of “pollution swapping” and identify practices that reduce these emissions. Farmers utilising these housed wintering systems typically add carbon (C)-rich material such as straw or sawdust as bedding material. Increasing the amount of straw used for bedding may reduce ammonia (NH₃) losses, an indirect source of N₂O, during housing and storage (Clemens and Ahlgrim, 2001; Webb et al., 2005). This paper presents findings from a 6-month-long manure storage trial, testing the hypothesis that NH₃ emissions from stored manure will decline as the input of C-rich material (straw and sawdust) increases.

2. Materials & Methods

Fresh dairy cattle excreta (dung and urine) were collected from a farm in early July 2011 and mixed with differing ratios of straw or sawdust to provide additional C. The high ratio of excreta to straw or sawdust was chosen to represent current practice on two South Otago dairy farms with housed wintering systems, while the low ratio was chosen to determine the effect of increasing inputs of these C materials. The straw was a mixture of barley and wheat in a ratio of 1:3 to represent the mix used on the representative farm. Characteristics of excreta and C materials are shown in Table 1 while treatments are shown in Table 2. On 6 July 2011 each treatment, replicated three times, was placed into a series of 0.5 m long upright plastic pipe, sealed at the base and buried, with the surface at ground level. NH₃ volatilisation was regularly measured over 6 months. Lids were placed over the gas measurement columns on 21 occasions for *ca.* 24 hours with air drawn through the headspace and dreschel bottles containing dilute sulphuric acid to trap ammonia. Following sample analysis, cumulative emissions were calculated by integrating measured losses.

3. Results & Discussion

Ammonia losses from stored excreta with no added C-rich material was equivalent to 48% of the initial total N content: this was reduced by 31-94% with the addition of C-rich materials (Table 3). As the straw and sawdust had the same C content (39%; Table 1), it was possible to relate C input to NH₃ loss, resulting in a significant negative relationship ($R^2 = 0.991$, $P = 0.004$; Figure 1). Addition of C-rich material such as straw and sawdust will increase the C:N ratio of the manure, thereby immobilising NH₄⁺, leading to a reduction in NH₃ loss. While sawdust was found to be more effective, due to a combination of higher rates, higher C:N ratio and lower pH, access to this material may limit its widespread use as bedding material. This work will be expanded to include N₂O and methane emissions, to provide full greenhouse gas accounting.

Table 1. Characteristics of tested excreta and C materials.

Manure	pH	Total N (%)	Total C (%)	C:N
Dung	6.4	0.5	6.7	13
Urine	8.4	0.47		
Straw mixture (Barley and wheat)	6.9	0.54	39	73
Sawdust	4.3	0.14	39	272

Table 2. Treatments for the manure storage trial.

Treatment	Components in columns	C added (g C/kg Fresh Weight excreta)
Control	Excreta only, dung:urine = 1:1.3	-
Excreta + straw @ low rate	Excreta:straw mixture = 25:1 w/w	15
Excreta + straw @ high rate	Excreta:straw mixture = 10:1 w/w	39
Excreta + sawdust @ low rate	Excreta:sawdust = 2.5:1 w/w	156
Excreta + sawdust @ high rate	Excreta:sawdust = 1:1 w/w	390

Table 3. Manure characteristics and loss of NH₃ following 6 months storage.

Treatment	Initial total N (%)	NH ₃ -N loss	
		(% of initial N; Mean ± SEM)	Reduction in NH ₃ loss (%)
Control	4.7	47.8 (2.2)	
Excreta + straw @ low rate	4.7	33.1 (2.5)	31%
Excreta + straw @ high rate	4.8	22.6 (1.8)	53%
Excreta + sawdust @ low rate	4.7	9.1 (1.1)	81%
Excreta + sawdust @ high rate	4.8	3.0 (0.7)	94%

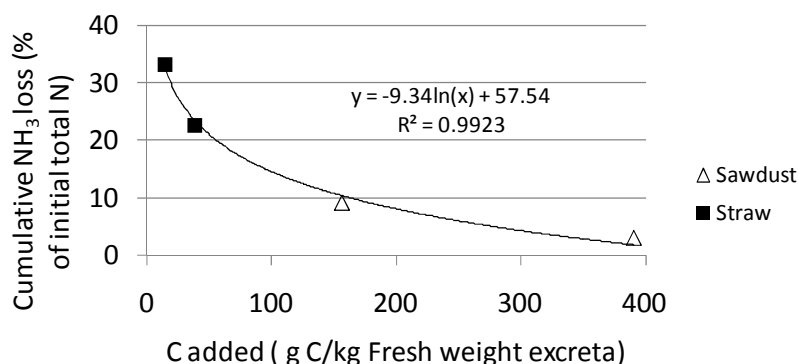
Figure 1. Effect of increasing C input on NH₃ volatilisation from stored excreta.

4. Conclusion

This study has shown that the addition of straw and sawdust as bedding material also provides an effective method for reducing NH₃ losses through immobilisation of mineral N. However, inputs of C-rich material need to consider cost of material and increases in bulk manure to be land applied following storage.

References

- Webb, J., Menzi, H., Pain, B.F., Misselbrook, T.H., Dammgen, U., Hendriks, H., Dohler, H. 2005. Managing ammonia emission from livestock production in Europe. *Environmental Pollution* 135, 399-406.
- Clemens, J. and Ahlgrimm, H-J. 2011. Greenhouse gases from animal husbandry: mitigation options. *Nutrient Cycling in Agroecosystems* 60, 287-300.

Modeling the effect of nitrogen management on nitrogen losses, net energy balance and plant quality in a wheat-rapeseed rotation

Gallejones, P.^a, Aizpurua, A.^b, Del Prado, A.^a

^aBC3. Basque Centre for Climate Change. Bilbao, Spain.

^bNEIKER-Basque Institute for Agricultural Research and Development, Derio, Spain.

1. Background & Objectives

Nitrogen (N) is the main nutrient limiting factor in most agricultural systems, requiring the application of N fertilizers to optimize crop production. A well balanced fertilizer strategy does not necessarily imply using a yield-based target only; it may also involve plant quality parameters. Management practices involving fertilizer N should be efficient in order to minimize adverse effects on the environment. Since only a fraction of the applied N is taken up by the crop, the remainder is subject to loss, representing economic cost and environmental risk contributing to eutrophication in waters via nitrate leaching losses, acidification of terrestrial ecosystems by ammonia and mono-nitrogen oxides emissions and global warming by nitrous oxide (N₂O). Other gasses such as carbon dioxide (CO₂) and methane (CH₄) are generated at different levels of the agricultural systems. These gasses and the N₂O, form the greenhouse gasses (GHG) which contribute to climate change. Some measures as bioenergy crops can reduce indirectly the GHG emissions substituting fossil fuels by biofuels. It is important to develop tools that can estimate the fertilizer N requirements of a crop and predict N losses to the environment. The aim of this study is to describe a framework that integrates simulation of energy and N flows and losses with emissions from the rest of the stages from bioenergy cropping systems.

2. Materials & Methods

This study describes the principles and stages to develop a mass-balance N cycle model for arable cropping systems using some of the principles used for mass-balance N modeling in grasslands (Scholefield et al., 1991; Brown et al., 2005). The new model was constructed using data from several experiments carried out in different areas of Spain (Quemada, 2006) and is intended to be applicable to wheat-rapeseed rotations in northern Spain. The model simulates the cycling of N in arable cropping systems and predicts environmental losses on the basis of fertilizer application and soil and site characteristics. Field-scale simulated N losses can be integrated within a life cycle assessment (LCA) to study the effect of fertilization on N emissions of some products and byproducts such as biofuels from energy crops. Data from a field experiment conducted under the humid Mediterranean climate in northern Spain (Gallejones et al., *subm.*) were used to determine a partial LCA of winter oilseed rape (*Brassica napus* L.) as affected by N fertilization. The environmental and energy flows associated with biodiesel production were quantified for different N fertilizer rates. The life cycle inventory of biofuels in this analysis included four subsystems: crop production, handling and storage of seeds, transport of the seeds and biofuel production.

3. Results & Discussion

Nitrogen fertilization significantly increased yield of rapeseed by 60% ($p < 0,001$) but it reduced the oil concentration in the seed. The highest oil yield (kg ha⁻¹), however, was achieved with the highest N rate which increased the total amount of biodiesel obtained (energy output, MJ ha⁻¹). Rathke et al., (2005) indicate that oil content is expected to decrease in a linear fashion with increasing fertilizer N; so we

could have expected a maximum oil yield at a lower fertilizer rate than that observed for maximum yield. The energy input (MJ ha^{-1}) was also higher if N fertilizer was applied but taking into account the energy output, the zero N application resulted in the highest energy consumption in terms of MJ MJ^{-1} . The total GHG emissions increased with N application by increasing the percentage of GHG emissions from N fertilizer up to 56% with the highest rates of N fertilizer (180 and 220 kg ha^{-1}). The emissions of N_2O also increased with N fertilizer and corresponded to 50% of the GHG emissions from N fertilizer. Overall soil N_2O emissions accounted for 21% to 28% of the GHG emissions associated with biodiesel production.

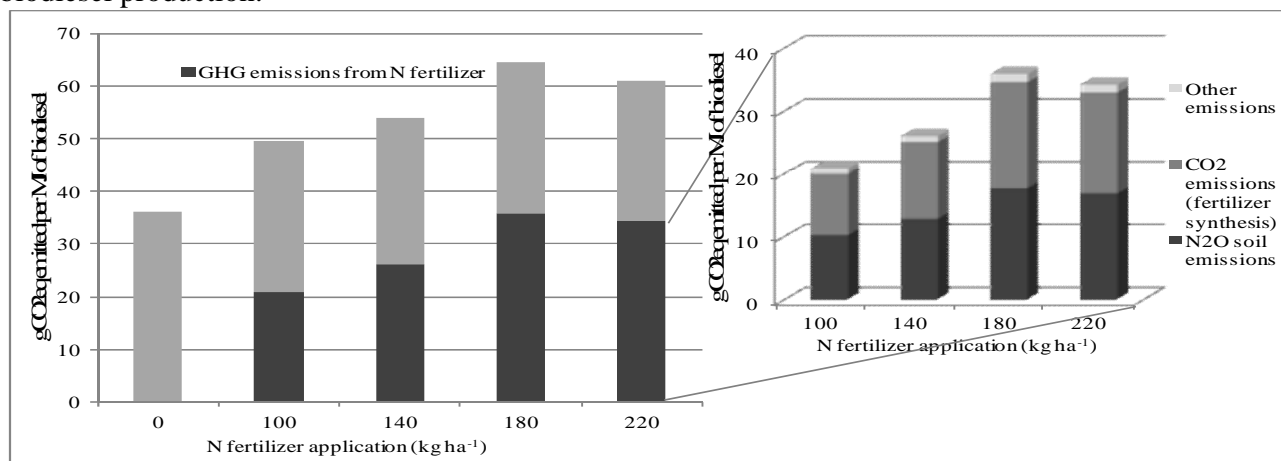

Figure 1. Estimated GHG emissions from biodiesel production (left) and display of different kind of GHG emissions from N fertilizer production and use (right) in CO_2 -equivalents per MJ of biodiesel at field-scale.

4. Conclusion

The optimal N rate applied to winter oilseed rape depends on the aim of production. High N rates are required for high yield but normally a lower rate is needed for higher energy output. GHG emissions from N fertilisation were the most important item of the total emissions in the biodiesel production at field-scale, with the emissions of N_2O from soil being a significant factor. However, future research should include allocation methods for a more precise calculation and results of N_2O emissions from field studies as there is much variation depending on the type of soil and weather conditions.

References

- Brown, L., Scholefield, D., Jewkes, E.C., Lockyer, D.R. and del Prado, A. 2005. NGAUGE: a decision support system to optimise N fertilisation of British grassland for economic and/or environmental goals. *Agriculture, Ecosystems and Environment* 109, 20-39.
- Callejones, P., Castellón, A., del Prado, A., Unamunzaga O. and Aizpurua A. (subm.). Nitrogen and sulphur fertilization effect on leaching losses, nutrient balance and plant quality in a wheat-rapeseed rotation under humid Mediterranean climate. *Nutrient Cycling in Agroecosystems*.
- Quemada, M. 2006. Balance de nitrógeno en sistemas de cultivo de cereal de invierno y de maíz en varias regiones españolas. *Monografías INIA, serie agrícola n°21*.
- Rathke, G.W., Christen, O. and Diepenbrock, W. 2005. Effects of nitrogen source and rate on productivity and quality of winter oilseed rape (*Brassica napus* L.) grown in different crop rotations. *Field Crops Res.* 94 (2-3), 103-113.
- Scholefield, D., Lockyer, D.R., Whitehead, D.C. and Tyson, K.C. 1991. A model to predict transformations and losses of nitrogen in UK pastures grazed by beef-cattle. *Plant Soil* 132, 165-177.

N fertilization and diazotrophic bacteria inoculation in sugarcane for bioenergy production

Cantarella, H.^a, Montezano, Z.F.^a, Gava, G.J.C.^b, Rossetto, R.^c, Vitti, A.C.^c, Vargas, V.P.^a, Soares, J.^a, Oliveira, C.A.^a, Joris, H.A.W.^a, Kölln, O.T.^d, Dias, F.L.F.^c, Urquiaga, S.^e

^aAgronomic Institute of Campinas, Campinas, SP, Brazil; ^bAPTA, Jau, SP, Brazil; ^cAPTA, Piracicaba, SP, Brazil;

^dCENA-USP, Piracicaba, SP, Brazil; ^eEMBRAPA, Seropédica, RJ, Brazil

1. Background & Objectives

Ethanol from sugarcane represents almost half of the liquid fuels used for light vehicles in Brazil. Nitrogen (N) fertilizers are responsible for 25% of the energy input in agriculture operations for sugarcane production (Boddey et al., 2008) or almost 40% of the green house gases emissions (Lisboa et al., 2011). Therefore, N fertilization can significantly affect the energy balance and environmental benefits of sugarcane ethanol. It is known that diazotrophic bacteria can supply part of the N of sugarcane (Urquiaga et al., 2011) and recently an inoculant was developed for this crop, containing five species of bacteria. The objective of this paper was to evaluate the response of sugarcane to N fertilization with and without inoculation of N-fixing endophytic bacteria.

2. Materials & Methods

Five field experiments were established in 2008-2009 in different sites in the State of São Paulo, the major sugarcane production region of Brazil. The treatments in the cane plant cycle corresponded to a zero-N fertilizer control and three rates of N (30, 60, and 90 kg ha⁻¹). In two additional plots (zero N and the intermediate N rate) sugarcane plants were inoculated with a mixture of five species of diazotrophic bacteria. In each site three sugarcane varieties were tested and four replicates were used, comprising 72 plots in total. Following the harvesting of the plant cane, the N treatments and the inoculation were reapplied to the ratoons (new shoots that grow after harvest) but the N rates were increased to 50, 100, and 150 kg ha⁻¹. Only two fields of the ratoon cycle were harvested so far. Therefore, seven harvests were considered. At harvesting, the millable stalks were separated from dry leaves and tops. Cane yields, sugar content of stalks, and nutrients taken up and exported were calculated. Data were subject to analysis of variance, adjusted with regression equations, and means compared by the Tukey test.

Table 1. Response of sugarcane to N fertilization or diazotrophic bacteria

Sites	Cycle	Average cane yield (t/ha)	F test	
			N rate	Inoculation
Sales I	Plant	114.6	L**	ns
Sales II	Plant	101.5	Q*	ns
Piracicaba	Plant	111.5	ns	ns
Jaú	Plant	130.8	ns	ns
Sta Maria	Plant	74.8	Q**	ns
Sales I	Ratoon	68.1	Q**	ns
Sales II	Ratoon	69.7	ns	ns

3. Results & Discussion

In three out of five sites there was a positive response to N fertilization in the plant cane cycle. Average yields in plant cane varied from 75 to 131 t ha⁻¹ of fresh stalks (Table 1). In the ratoon cycle, responses do N were significant in one site; therefore, in the whole, the experiments were adequate to compare N fertilization with bacteria inoculation. Crops inoculated with diazotrophic bacteria did not result in increased stalk yields, whereas N fertilizer brought about significant increases ($P \leq 0.05$) in stalk (Figure 1) as well as sugar yields. These results are compatible with those of other N nutrition studies in Brazil (Rossetto et al., 2010). Response to N varied with cane cultivars, but yields of none of the plant materials were significantly affected by inoculation. In general, N fertilizer application raised leaf and whole plant N content but did not affect stalk sugar concentration; inoculation did not show clear effect on these attributes. However, Pereira (2011)

observed a yield increase due to inoculation of plant cane of the variety RB72454 but not for several other materials; in ratoons of variety SP80-3280 he also noticed an increase in stalk production with inoculation when N was not applied. None of these varieties were included in the present study. Urquiaga et al. (1992) had already shown that N fixation in sugarcane varied markedly among varieties. The results suggest that inoculation, with present technology, is not likely to bring widespread benefits, or replace N fertilization in sizeable scale, in sugarcane production in Brazil in the near future. In fact, Hoefsloot et al. (2005) suggested that biological N fixation (BNF) did not represent a significant source of N for sugarcane elsewhere. However, Urquiaga et al. (2011) indicated that Brazilian sugarcane varieties can obtain about 40 kg/ha N from BNF. N fertilization in Brazil is usually lower than in most other countries with comparing yields. If inoculation is not promoting yield increases perhaps the contribution of BNF is already built into the sugarcane production system.

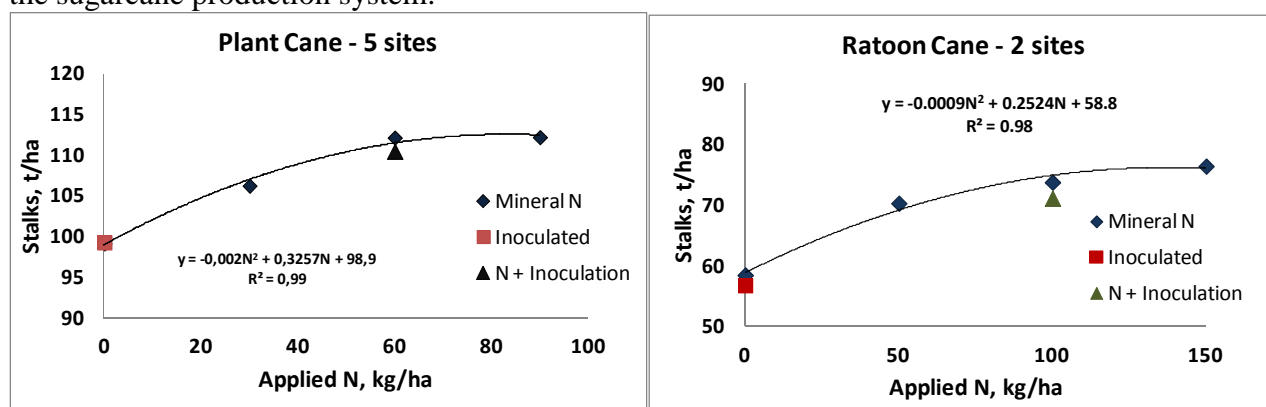

Figure 1. Response of sugarcane stalk yield to N fertilizer and diazotrophic bacteria inoculation in plant cane (average of five sites) and ratoon cane (average of two sites).

4. Conclusion

Despite evidences of BNF in sugarcane, inoculation of N-fixing bacteria cannot replace mineral N fertilization in the sites studied.

References

- Boddey, R.M., Soares, L.H.B., Alves, B.J.R. and Urquiaga, S. 2008. Bio-ethanol production in Brazil, In: Pimentel D. (ed.), Renewable Energy Systems: Environmental and Energetic Issues, Springer, New York. pp. 321-356.
- Hoefsloot, G., Termorshuizen, A.J., Watt, D.A. and Cramer, M.D. 2005. Biological nitrogen fixation is not a major contributor to the nitrogen demand of a commercially grown South African sugarcane cultivar. *Plant and Soil* 277, 85-96.
- Lisboa, C.C., Butterbach-Bahl, K., Mauder, M. and Kiese, R. 2011. Bioethanol production from sugarcane and emissions of greenhouse gases - known and unknowns. *Global Change Biology Bioenergy*. DOI: 10.1111/j.1757-1707.2011.01095.x
- Pereira, W. 2011. Productivity and technological quality of sugarcane inoculated with diazotrophic bacteria. Instituto de Agronomia, UFRRJ, Seropédica, RJ. Master Dissertation, pp. 70. (In Portuguese)
- Rossetto, R., Dias, F.L.F., Landell, M.G.A., Cantarella, H., Tavares, S., Vitti, A.C. and Perecin, D. 2010. N and K fertilisation of sugarcane ratoons harvested without burning. *Proceedings of the International Society of Sugar Cane Technologists*, 27, 1-8
- Urquiaga, S., Cruz, K.H.S. and Boddey, R.M. 1992. Contribution of nitrogen fixation to sugar cane: nitrogen-15 and nitrogen balance estimates. *Soil Science Society of America Journal* 56, 105-114.
- Urquiaga S., Xavier R.P., Morais R.F., Batista R.B., Schultz N., Leite J.M., Sa J.M., Barbosa K.P., Resende A.S., Alves B.J.R., Boddey R.M. 2011. Evidence from field nitrogen balance and ^{15}N natural abundance data for the contribution of biological N_2 fixation to Brazilian sugarcane varieties. *Plant and Soil online*. DOI: 10.1007/s11104-011-1016-3.

N₂O emissions from radiata pine, Douglas fir and beech forest stands in the Basque Country.

Barrena, I.^a, Estavillo, J.M.^a, Duñabeitia, M.^a, Merino, P.^b, González-Murua, C.^a, Menéndez, S.^c

^aDepartment of Plant Biology and Ecology, University of the Basque Country (UPV/EHU), Apdo. 644, E-48080 Bilbao, Spain.

^bNEIKER-Tecnalia. Dept. Ecotecnologías. Barrio Berreaga, 1. 48160 Derio (Bizkaia), Spain

^cAgrobiotechnology Institute (IdAB). Campus de Arrosadía, E-31192, Mutilva Baja, Spain.

1. Background & Objectives

Nitrous oxide (N₂O) is considered a problematic greenhouse gas due to its longevity in the atmosphere (120 years) and its high relative absorption capacity. Forests are considered excellent systems for carbon sequestration to mitigate the greenhouse effect. However, there are no studies regarding N₂O emissions from forest systems in our edaphoclimatic conditions. Forestry in the Basque Country is one of the most important primary sector activities, being 55% of the total area of the Basque Autonomous Community forest surface (Inventario Forestal CAE, 2005). The aim of this work was to determine and compare the magnitude of N₂O emissions in the main forest plantation in our region (radiata pine) with another forestry interest plantation such as Douglas fir and with a beech forest as representative of natural forests.

2. Materials & Methods

The experiment was carried out in three different mature stands of radiata pine (*Pinus radiata* D. Don), Douglas fir (*Pseudotsuga mensiezii* Mirb.) and beech (*Fagus sylvatica* L.). Radiata pine and Douglas fir stands are located at Artzentales (43°13' N, 3° 11' W, 350m altitude), while the beech stand is at the Natural Park of Gorbea (43° 6' N, 2° 48' W, 400m altitude). Soil properties for the stands are described in Table 1.

Table 1. Soil properties in each stand.

Stand	Density	Texture	pH	O.M. (%)	N (%)	C/N
Pine	1,20	Loam	4.71	4.99	0.26	11.16
Douglas Fir	1,26	Clay-Loam	4.25	7.55	0.32	13.72
Beech	1,02	Clay-Loam	4.41	8.38	0.42	11.60

Nitrous oxide emissions were measured using a closed chamber technique (Menendez et al., 2008) every two weeks from January 2010 to December 2011. Emission rates were calculated taking into account the concentration increase in time within the chamber. Samples were analysed by gas chromatography (Agilent, 7890A) with an electron capture detector. A capillary column (IA KRCIAES 6017: 240°C, 30 m × 320 µm) was used. The column's temperature ramped from 40°C to 80°C and ECD's temperature was 350°C, and 5% mixture of Ar with CH₄ was used as carrier and N₂ as make up (15 ml min⁻¹). A headspace autosampler (Teledyne Tekmar HT3) was connected to the gas chromatograph. Standards of N₂O were stored and analysed at the same time as samples. Cumulative N₂O emissions along the experiment were estimated by averaging the fluxes of two successive determinations, multiplying that average flux by the length of the period between the measurements, and adding that amount to the previous cumulative total.

3. Results & Discussion

Among the coniferous species stands, Douglas fir had higher soil organic matter and nitrogen (N) contents than radiata pine (Table 1). These differences in soil properties are likely responsible for the approximately four times higher cumulative N₂O emissions determined in the Douglas fir stand than in radiata pine over the two years of the study. These cumulative emissions were of 522 and 126 g N₂O-N ha⁻¹ for Douglas fir and radiata pine, respectively (Figure 1). In the case of Douglas fir

daily emissions ranged between a minimum rate of $0.02 \text{ g N}_2\text{O-N ha}^{-1}\text{d}^{-1}$ and a maximum of $2.51 \text{ g N}_2\text{O-N ha}^{-1}\text{d}^{-1}$, with a mean emission rate of $0.75 \pm 0.22 \text{ g N}_2\text{O-N ha}^{-1}\text{d}^{-1}$, while in the case of radiata pine daily rates ranged between a minimum of $0.58 \text{ g N}_2\text{O-N ha}^{-1}\text{d}^{-1}$ and a maximum of $1.17 \text{ g N}_2\text{O-N ha}^{-1}\text{d}^{-1}$, with a mean of $0.26 \pm 0.16 \text{ g N}_2\text{O-N ha}^{-1}\text{d}^{-1}$. Regarding the beech stand, the cumulative emission over the study period was of $10 \text{ g N}_2\text{O-N ha}^{-1}$, approximately 50 and 10 times lower cumulative emission than the Douglas fir and radiata pine, respectively. Although the soil organic matter content of the beech stand and that of Douglas fir were similar, and the soil N content was higher in the beech stand, daily N_2O emission rates from the beech stand were low and very stable over time. Thus, the changing environmental conditions did not produce fluctuations in N_2O emissions along the time, as occurred with the Douglas fir. In this sense, daily emissions in the beech stand ranged between a minimum of $-0.39 \text{ g N}_2\text{O-N ha}^{-1}\text{d}^{-1}$ and a maximum of $0.51 \text{ g N}_2\text{O-N ha}^{-1}\text{d}^{-1}$, with a mean of $0.02 \pm 0.02 \text{ g N}_2\text{O-N ha}^{-1}\text{d}^{-1}$. In the review by Dalal and Allen (2008) dealing with N_2O emissions from natural ecosystems worldwide, daily mean emission rates from temperate forests are reported ranging between 0.02 and $22 \text{ g N}_2\text{O-N ha}^{-1}\text{d}^{-1}$, with a mean emission rate of $4.3 \text{ g N}_2\text{O-N ha}^{-1}\text{d}^{-1}$. Our daily emission rates are within this reported range, while our mean rates are below the mean reported for temperate forests. On the other hand, our data show that our stands of coniferous plantations contribute more to N_2O emissions to the atmosphere than do beech stand.

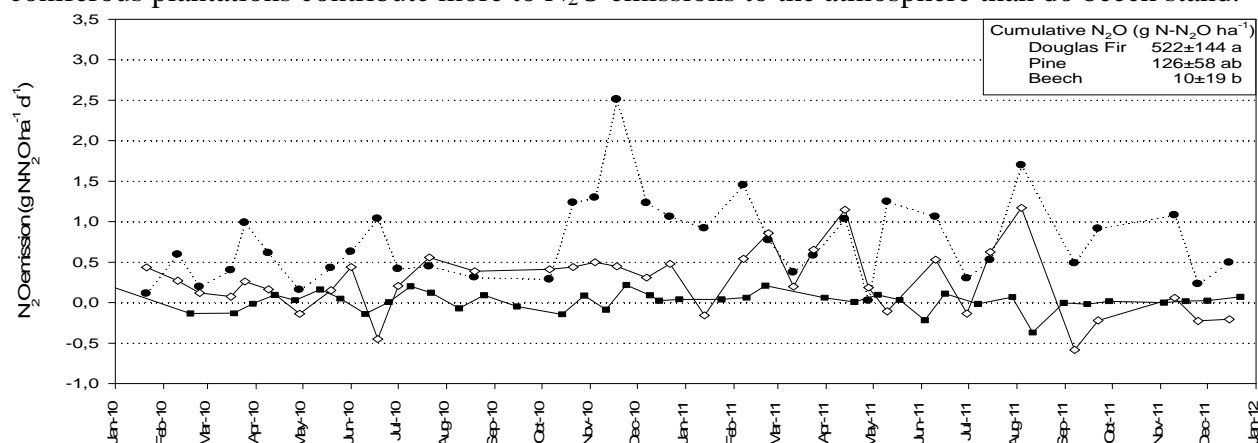

Figure 1. Daily N_2O emissions for (■)Beech, (●)Douglas fir and (◇)Radiata pine; and cumulative N_2O losses over the two years of the study (different letters indicate significantly different rates using Duncan Test; $p < 0.01$)

4. Conclusion

In the Basque Country edaphoclimatic conditions, N_2O emissions from measured stands soils are higher in radiata pine and Douglas fir, being around 10 and 50 times higher respectively, than in beech stands.

Acknowledgement: This project was funded by the Spanish Government (AGL2009-13339-CO2-01), by the Basque Government (K-EGOKITZEN, ETORTEK 2010-2012) and by the University of the Basque Country (IT526-10). I. Barrena is the recipient of a predoctoral fellowship from the Department of Education, Universities and Investigation of the Basque Government.

References

- Dallal, R.C. and Allen, D.E. 2008. Greenhouse gas fluxes from natural ecosystems. *Australian Journal of Botany* 56, 369-407.
- Inventario Forestal 2005. 2005. Departamento de Agricultura, Pesca y Alimentación, Gobierno Vasco.
- Menéndez, S., Lopez-Bellido, R.J., Benitez-Vega, J., Gonzalez-Murua, C., Lopez-Bellido, L. and Estavillo, J.M. 2008. Long-term effect of tillage, crop rotation and N fertilization to wheat on gaseous emissions under rainfed Mediterranean conditions. *European Journal of Agronomy* 28, 559-569.

Nitrate leaching to the groundwater investigated for different management practices of organic farming and wine growing

Feichtinger, F., Scheidl, A.

Federal Agency for Water Management , Institute for Land and Water Management Research, Petzenkirchen, Austria

1. Background & Objectives

Exceeding the limit value of the nitrate concentration for drinking water in a regional groundwater body caused a scientific programme addressing this issue. The nitrate concentration of the seepage water should be investigated for different management practices of organic farming and of vine yard cultivation.

2. Materials & Methods

Different types and dates of tillage with and without intercropping have been investigated for organic farming. Bare soil, permanent grassland and temporary grassland between the vine stocks have been investigated as varieties of vineyard management. The experiment is designed in that way that soil water has been collected at the lower end of the rooting zone during periods of leaching using suction cups, collecting bottles and a vacuum pump, which is controlled by a soil water sensor.

3. Results

The instrumentation in the field was finished in October 2011 and during the coming winter half year percolating water will be collected for the first time. The experiment will be described in detail and first results will be presented.

4. Conclusion

The investigations are a contribution to find management practices for organic farming and wine growing, where the nitrate concentration of the seepage meets the limit value for drinking water.

Nitrogen balances of Swiss agriculture from 1975 to 2009

Spiess, E.^a

^a Agroscope Reckenholz-Tänikon Research Station ART, Reckenholzstrasse 191, CH-8046 Zurich, Switzerland

1. Background & Objectives

The progressive intensification of Swiss agriculture after World War II, characterized by growing inputs of nitrogen (N), resulted in a strong increase in productivity but also in rising environmental and health problems. An efficient reduction of ammonia and nitrous oxides emissions to air and nitrate losses to water requires a thorough knowledge of N flows in agriculture, e.g. by calculating N balances. In 1994 the first farm-gate balance of N was calculated for Swiss agriculture on behalf of the International Commission for the Protection of the Rhine (ICPR) and the Oslo and Paris Conventions for the Prevention of Marine Pollution (OSPAR). In 1996 N balance became a major agri-environmental indicator for monitoring the environmental performance after the introduction of direct payments bound to integrated production (IP), organic agriculture and other ecological programmes. The objective of this paper is to present the time course of N balances of Swiss agriculture in the last decades.

2. Materials & Methods

The farm-gate balance is mainly encouraged by OSPAR and essentially considers the agricultural production system to be a "black box". This balance is calculated as the difference between total imports from abroad and other economic sectors into agriculture, on the one hand, and total exports of agricultural products, on the other (OSPAR 1995). Inputs into agriculture comprise imported feedstuffs, mineral fertilizers, recycling and other fertilizers (sewage sludge, compost, etc.), imported seed (negligible for Switzerland and, therefore, not presented in the following), biological N fixation and atmospheric deposition. Outputs from agriculture encompass plant (bread cereals, table potatoes, etc.) and animal foodstuffs (milk, meat, eggs, etc.) and other animal products (by-products of meat production such as hides, animal meal, etc.). The balance, i.e. the difference between nutrient inputs and outputs, is in most cases positive (= surplus) and comprises the changes in soil nutrient stocks (increase or decrease in nutrient contents of soil) and total nutrient losses. A detailed description of used methods is found in Spiess (2011).

3. Results & Discussion

In 2009, 150 kg N ha⁻¹ of utilized agricultural area (UAA) entered the agricultural sector of Switzerland, with mineral fertilizer, imported feedstuffs and biological N fixation being the largest input sources (Figure 1a). In contrast, 44 kg N ha⁻¹ left agriculture, with N quantities in animal foodstuffs and other products being more than three times larger than N in plant foodstuffs (Figure 1b). The resulting surplus amounted to 106 kg N ha⁻¹. As changes in soil stocks are generally supposed to be insignificant for N, most of the N surplus may be lost through ammonia volatilization, nitrate leaching and denitrification.

Between 1975 and 1996, N input in imported feedstuffs was halved (Figure 1a). Demand for feed decreased because of lower animal numbers and N contents of pig feed. On the other hand, imported feedstuffs were partly replaced by a higher domestic production. Since 1996, however, imports of feedstuffs have been increasing by some 20 kg ha⁻¹. More soybean meal has been imported following the ban on feeding animal meal due to the mad-cow disease (BSE) crisis in Switzerland. Use of mineral N fertilizer nearly doubled between 1975 and 1988. It then decreased until 1997 and has been more or less constant since then. The use of recycling and other fertilizers

decreased after 1997 because of the ban on sewage sludge application announced for 2006. Biological N fixation, mainly originating from the large grassland area with grass-clover swards, remained constant over the whole period. N deposition steadily decreased after a slight increase until 1980. Not only nitrogen oxides emissions from traffic and industry but also ammonia emissions were reduced, the latter following a reduction in the animal population and thus the quantity of animal manure produced.

N outputs in foodstuffs and other products changed only slightly over time (Figure 1b). N surplus initially rose sharply to a maximum of 145 kg ha⁻¹ in 1980, then decreased to 106 kg ha⁻¹ in 1997 and remained at the same level until 2009. The accentuated reduction between 1992 and 1997 was principally due to the introduction of direct payments for ecological programmes such as integrated production in 1993. As a result, many farmers had to reduce their fertilizer use in order to comply with an equilibrated whole-farm nutrient balance. In 1997, most farmers were already participating in these programmes. Regarding the input items, substantial decreases were seen especially in deposition over the whole period and mineral fertilizer from 1988 onwards. The overall reduction in surplus between 1980 and 2009 amounted to 29%.

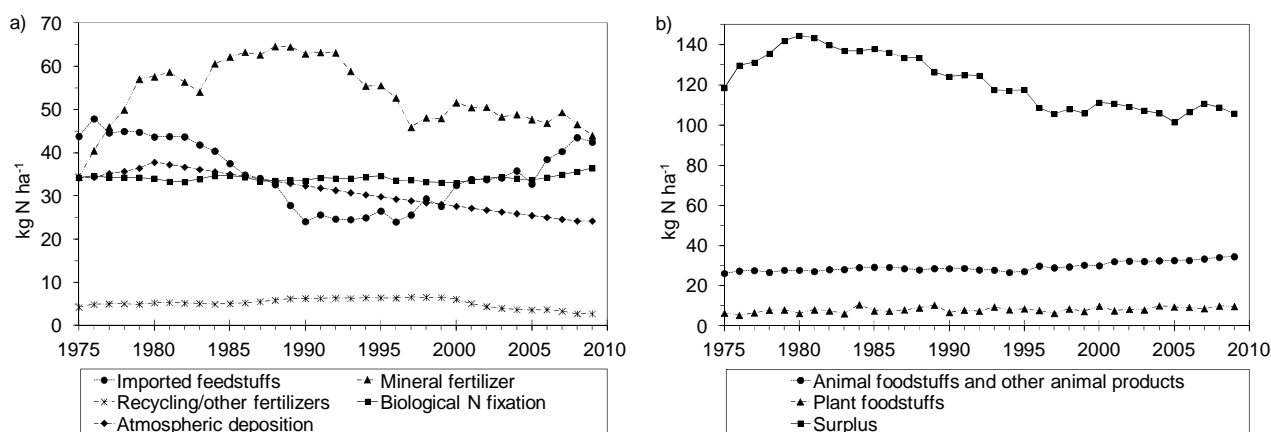

Figure 1. Development of N amounts in balance items of Swiss agriculture from 1975 to 2009 (in kg N ha⁻¹ UAA).
a) Input items. b) Output items and surplus.

4. Conclusion

Mineral fertilizer and imported feedstuffs turned out to be the major input items of N balance of Swiss agriculture. A further decrease in surplus requires farm managers to reconsider the size of these inputs into their farms. This might be achieved by increasingly using feeding and nutrient management plans, leading above all to lower nutrient excretion of livestock and an improved application of manure in time and space. Mineral fertilizer use, in return, might be reduced by better manure management.

References

- OSPAR (1995) PARCOM guidelines for calculating mineral balances. Summary record of the programmes and measures committee (PRAM), Oviedo, 20–24 February 1995. Oslo and Paris Conventions for the Prevention of Marine Pollution (OSPAR), Annexe 15. <http://www.ospar.org/documents/dbase/decrecs/agreements/95-02e.doc>. Accessed 20 December 2011.
- Spiess, E. 2011. Nitrogen, phosphorus and potassium balances and cycles of Swiss agriculture from 1975 to 2008. *Nutrient Cycling in Agroecosystems* 91, 351-365.

Nitrogen dynamics in soil amended with acidified and non acidified cattle slurry and derived liquid fraction

Fangueiro, D.^a, Surgy, S.^a, Coutinho J.^b, Cabral, F.^a

^aUIQA, Instituto Superior de Agronomia – Technical University of Lisbon, 1349-017 Lisbon, Portugal

^bC. Química, Dep Biologia e Ambiente, UTAD, Ap. 1013, 5001-911 Vila Real, Portugal

1. Background and Objectives

Acidification of animal slurries is promoted to reduce ammonia emissions but there is little knowledge about the effect of such treatment on nitrogen dynamics after soil application. Previous works (Eriksen et al., 2008; Sorensen and Eriksen, 2009) showed that incorporation of acidified slurries can affect soil processes, namely the carbon and nitrogen dynamics and recently, Fangueiro et al. (2010), observed a delay in nitrification in soils amended with acidified pig slurry or derived liquid fraction, relative to untreated materials. However, no information is available concerning the effect of cattle slurry acidification on N dynamics in soil, and considering the different composition of pig and cattle slurries, it is to believe that acidification may lead to distinct effects in both slurries. Hence, in the present work, N mineralization and nitrification were monitored in a soil amended with untreated and acidified cattle slurry or derived liquid fraction.

2. Materials & Methods

The liquid fraction (LF) of cattle slurry was obtained by centrifugation. Following this half of the LF and of the untreated slurry (US) were maintained at the original pH (10) and the second half was acidified to pH 5.5 to obtain the acidified slurry (AS) and acidified liquid fraction (ALF). 500 g of dry soil were mixed with US, AS, ALF or LF and placed into closed 1 L plastic containers. Distilled water was then added to reach 75% of soil water holding capacity. An aerobic incubation was performed over 58 days at 25°C. On days 0, 3, 6, 13, 22, 36, 50, 58 of the incubation period, 10 g of soil were sampled from each container and soil mineral N (NH₄⁺-N and NO₃⁻-N) content was quantified. Based on the values of the NO₃⁻-N and total mineral-N concentrations obtained in each treatment, the net nitrification (NN) and net N mineralization (NNM), respectively, was calculated at time t as follows:

$$\text{NNt (mg N kg}^{-1}\text{)} = [\text{NO}_3^{-}\text{-N}]_t - [\text{NO}_3^{-}\text{-N}]_{t=0}$$

$$\text{NNMt (mg N kg}^{-1}\text{)} = [\text{total mineral N}]_t - [\text{total mineral N}]_{t=0}$$

Results were analyzed by analysis of variance (one way-ANOVA) to test the effects of each treatment and time independently. The statistical significance of the mean differences was determined by the least significant difference (LSD) tests based on a t-test at a 0.05 probability level. The statistical software package used was *R*.

3. Results & Discussion

The NH₄⁺-N concentration of US and LF amended soils rapidly decreased during the first days of incubation to reach the base line (control) on day 14 (Figure 1). The NH₄⁺-N concentration remained constant during the first 3 days in the AS amended soil, then decreased until day 22 and finally stabilized but values were always significantly higher than in US amended soil. The NH₄⁺ concentration in the ALF amended soils increased slightly during the first 5 days and then remained significantly higher than in all other treatments over the whole experiment. A similar trend of NH₄⁺ concentration in soil amended with acidified and non acidified pig slurry and/or liquid fraction was observed in previous works (Plaza et al., 2005; Fangueiro et al., 2010)

Net N mineralization was observed in all treatments over the incubation period and the N mineralization in soils amended with acidified slurry or LF was always significantly lower than in

soils amended with non acidified materials, in agreement with previous results reported by Sorensen and Eriksen (2009).

Nitrification in soils amended with AS and ALF was always significantly lower than in soils amended with US and LF. The same trend was reported in previous work by Fangueiro et al. (2010) using pig slurry, but the effect of acidification on nitrification was shorter. The nitrification in ALF amended soil remained similar or lower than in control. Hence, it may be hypothesized that acidification of the US and LF delays or inhibits the nitrification process in soil. Furthermore, it was shown here that this effect was more pronounced in ALF than AS treated soil. The effect on nitrification observed here after ALF application to soil is similar to those observed in soils treated with nitrification inhibitors (Fangueiro et al., 2009).

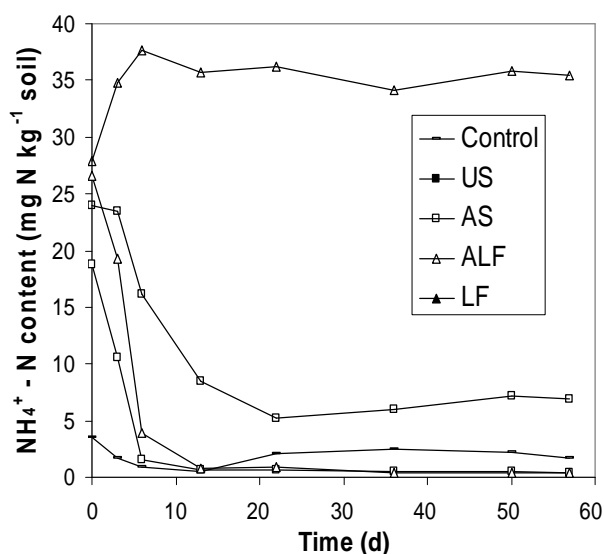

Figure 1. NH_4^+ -N concentration in soil amended with acidified and non-acidified cattle slurry or liquid fraction (N=4).

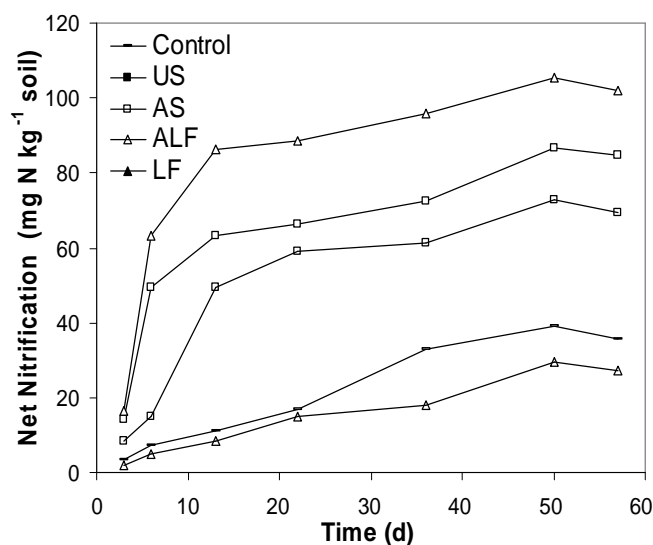

Figure 2. Net nitrification in soil amended with acidified and non-acidified cattle slurry or liquid fraction (N=4).

4. Conclusion

Our results showed that the application to soil of acidified slurry or derived liquid fraction have a significant impact on the nitrification and N mineralization process since acidification significantly slow down nitrification. The potential as nitrification inhibitor may be considered as another benefit of slurry acidification since it may, indirectly, decrease nitrate leaching.

References

- Eriksen J., Sorensen P. And Elsgaard L. 2008. The fate of sulfate in acidified pig slurry during storage and following application to cropped soil. *Journal of Environmental Quality* 37, 280–286.
- Fangueiro, D., Fernandes, A., Coutinho, J., Moreira, N. And Trindade, H. 2009. Influence of nitrification inhibitors on annual ryegrass yield and soil mineral N dynamics after incorporation with cattle slurry. *Communications in Soil Science and Plant Analysis* 40 (21), 3387-3398.
- Fangueiro D., Ribeiro H., Coutinho J., Cardenas L., Trindade H., Cunha-Queda C., Vasconcelos E. And Cabral, F. 2010. Nitrogen mineralization and CO_2 and N_2O emissions in a sandy soil amended with original or acidified pig slurries or with the relative fractions. *Biology and Fertility of Soils* 46 (4), 383-391.
- Plaza, C., García-Gil, J.C. and Polo A 2005. Dynamics and model fitting of nitrogen transformations in pig slurry amended soils. *Communications in Soil Science and Plant Analysis* 36, 2137–2152.
- Sørensen P. and Eriksen J. 2009. Effects of slurry acidification with sulphuric acid combined with aeration on the turnover and plant availability of nitrogen. *Agriculture Ecosystems and Environment* 131, 240–246.

Nitrogen leaching and nitrous oxide emissions from grassland soils receiving dairy soiled water

Minogue, D.^a, French, P.^b, Bolger, T.^c, Murphy, P.N.C.^d

^aTeagasc, Animal and Grassland Research and Innovation Centre, Grange, Co. Meath, Ireland

^bTeagasc, Animal and Grassland Research and Innovation Centre, Moorepark, Fermoy, Co. Cork, Ireland

^cSchool of Biology and Environmental Science, University College Dublin, Belfield, Dublin 4, Ireland

^dTeagasc, Agricultural Catchments Programme, Johnstown Castle Environmental Research Centre, Co Wexford, Ireland

1. Background & Objectives

Intensive dairy production is associated with high stocking rates and inputs of N in fertiliser and/or feed. Ireland has a national target of a 50 % increase in dairy production by 2020 which must be achieved while meeting environmental commitments in terms of water quality and greenhouse gas (GHG) emissions. Therefore, management strategies are required to maximise N use efficiency and minimise nitrate leaching and N₂O emissions on dairy farms (Casey and Holden, 2005; Humphreys, 2008). Dairy soiled water (DSW) is an effluent produced on Irish dairy farms through the regular washing of milking parlours and holding areas and is typically spread on grassland throughout the year. It has a high N fertiliser replacement value (NFRV) (Minogue et al., 2011) and can be substituted for inorganic fertiliser N. Land application is likely to be associated with some risk of nitrate leaching and N₂O emission and this is likely to vary with season of application and soil characteristics, such as drainage (moisture conditions). This work examined the effect of substituting DSW for fertiliser N at three different times of the year on N leaching and N₂O emissions from two drainage-contrasted grassland soils.

2. Materials & Methods

Nitrogen leaching and N₂O emission from 32 undisturbed grassland soil monolith lysimeters (30 cm diameter x 70 cm depth), managed at a relatively high total N input of 198 kg ha⁻¹ yr⁻¹, was measured over a year. There were two soils (a well drained Acid Brown Earth and a poorly drained Gleysol) and four treatments (Table 1): a control receiving fertiliser N (FN) (calcium ammonium nitrate (CAN)) through the growing season at agronomic rates, and 3 treatments with soiled water substituted for fertiliser N (on a total N basis) at different time periods (May-August (DSW1), September-December (DSW2) and January-April (DSW3)). For the DSW treatments, DSW was applied at the legal maximum rate of 50,000 l ha⁻¹ (33 kg N ha⁻¹) every six weeks during the soiled water application period and fertiliser N was applied at agronomic rates at other times. Concentrations and total fluxes of N were monitored in leachate and N₂O emissions were monitored using the static chamber method, sampling 0, 1, 4, 7, 14, 21 and 28 days after the application date.

Table 1. Experimental treatments, showing dates and rates (kg N ha⁻¹) of N application (bold data indicates a DSW application; all other applications are fertiliser N).

	28-Jan	11-Mar	22-Apr	21-May	2-Jul	13-Aug	24-Sep	5-Nov	17-Dec	Total
FN	0	33	33	33	33	33	33	0	0	198
DSW1	0	33	33	33	33	33	33	0	0	198
DSW2	0	0	33	33	0	33	33	33	33	198
DSW3	33	33	33	33	33	0	33	0	0	198

3. Results & Discussion

Average annual N leachate loss from the well drained Acid Brown Earth (14.9 kg ha⁻¹) was higher than from the poorly drained Gleysol (4.4 kg ha⁻¹). Leachate N losses amounted to 7 % and 2 % of

applied N, respectively. Drier soil conditions, better aeration and resultant nitrification, and more rapid vertical transport, as evidenced by more rapid Br breakthrough, likely account for the greater leachate losses from the Brown Earth. Despite the contrasting soil type and drainage conditions, however, total annual N₂O emission was not significantly different, at 4.97 and 6.11 kg N ha⁻¹, for the Brown Earth and Gleysol, respectively, suggesting that N₂O emission may not be as sensitive to soil type as might have been expected. Despite the increased hydrological load with DSW applications, leachate N loss for FN (12.0 kg ha⁻¹) was higher than for DSW1 (6.8 kg ha⁻¹) and DSW3 (7.5 kg ha⁻¹), but was not significantly different from DSW2 (12.2 kg ha⁻¹). Similarly, annual N₂O-N emissions were lower for DSW1 (4.0 kg ha⁻¹) and DSW3 (3.9 kg ha⁻¹) than DSW2 (8.0 kg ha⁻¹) or FN (6.4 kg ha⁻¹). Results suggest that substituting DSW for fertiliser N during the growing season (Spring to Summer) may decrease nitrate leaching by 37-43 % and N₂O emissions by 37-39 %. This may be due to the form in which N is applied in DSW; roughly two thirds as organic N and the balance largely as NH₄-N. In contrast, N in CAN is composed of 50 % NH₄-N and 50 % NO₃-N. Therefore, N applied in CAN may be more susceptible to leaching and also to nitrification and denitrification and resultant N₂O emission.

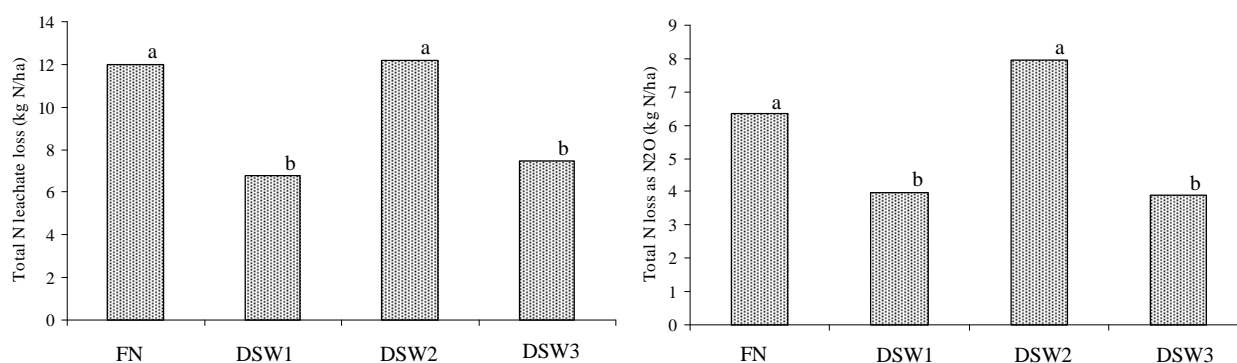

Figure 1. Total N losses in leachate and N₂O emission from the four treatments. Treatments with different letters are significantly different ($P < 0.05$).

4. Conclusion

Substituting DSW for fertilizer N during the growing season (Spring to Summer) may decrease nitrate leaching by 37-43 % and N₂O emissions by 37-39 %, possibly due to a lower susceptibility to leaching and N₂O emission of the organic N in DSW compared fertiliser N. This presents an opportunity to decrease fertiliser N use and costs, increase N use efficiency and decrease N leaching and GHG emissions on dairy farms through improved management of DSW. Due to the high NFRV of DSW, this may be done while maintaining the same level of grass growth. As might be expected, leachate losses of N are likely to be higher on more free-draining soils, but N₂O emission may not be as sensitive to soil drainage characteristics.

References

- Casey J.W. and Holden N.M. 2005. The Relationship between Greenhouse Gas Emissions and the Intensity of Milk Production in Ireland. *Journal of Environmental Quality* 34, 429-436.
- Humphreys J. 2008. Nutrient issues on Irish farms and solutions to lower losses. *International Journal of Dairy Technology* 61, 36-42.
- Minogue D., French P., Bolger T. and Murphy P. 2011. The fertiliser potential of dairy soiled water in temperate grasslands. *Agricultural Research Forum 2011*, Tullamore, Ireland, 8.

Nitrogen use efficiency improvement in heavy-pig production in Northern Italy

Della Casa, G.^a, Pacchioli, M. T.^b, Marchetti, R.^a

^aAgricultural Research Council CRA, Research unit for pig husbandry, Modena, Italy

^bResearch Centre on Animal Production – CRPA, Reggio Emilia, Italy

1. Background & Objectives

Italian livestock sector is concentrated in 5 regions of Northern Italy where about 70% of cattle, 85% of pigs (7.5 millions) and 80% of poultry are reared in intensively cultivated and inhabited areas. Protecting water bodies from nutrient pollution, as well as reducing odours from livestock in populated areas, represent very important issues of research and demonstration activities related to animal science in Italy. The Italian pig production chain is based on heavy pigs (160 kg and 9-month old) intended for industrial processing. During the finishing stage (80 to 160 kg live weight) the quantities of feed (soybean meal/corn based diet) supplied are limited, to slow down the animal growth rates. During this phase it is common practice to use diets containing 0.7-0.6% lysine and 14% crude protein.

The research project “Feeding techniques for the reduction of the environmental impact of N in Italian intensive farms” (RENAI) has studied how to reduce protein content in the heavy-pig diet in order to obtain a significant reduction in in the manure N content and ammonia emissions, without impairing productivity levels. The diets with reduced protein content were integrated with synthetic amino acids, in order to ensure the same essential-amino acid supply.

2. Materials & Methods

Two trials were undertaken with pigs from 100 to 165 kg live weight, using diets which were isoenergetic and isolysinic, but different in crude protein content (Table 1). In the first trial, crude protein was reduced by 2% (control diet 14% vs low-protein diet 12%), by reducing the percentage of soybean oil meal, and adding synthetic lysine and tryptophan; in the second trial (control diet 13% vs low protein diet 9%), soybean meal was not used and diets were integrated with synthetic lysine, methionine, threonine, tryptophan, isoleucine and valine. Average Daily Gain (A.D.G., g live weight/d) and Feed Conversion Rate (F.C.R., kg feed/kg weight gain) were measured *in vivo*. At slaughter carcass yield was recorded and carcass lean meat was measured with a Fat-O-Meter instrument. *In vivo* and slaughtering data were subjected to variance analysis with GLM procedure using the SAS System, 8.2 release for Windows. Nitrogen balance (Table 2) was calculated per pen (for each treatment 6 pens of 13 pigs in the first trial and 6 pens of 12 pigs in the second trial).

Table 1. Selected diets characteristics

Nutrients		Animal live weight (kg)					
		from 100 to 120		from 120 to 140		from 140 to 165	
		Control	Low protein	Control	Low protein	Control	Low protein
<i>First trial</i>							
Crude protein	%	14.3	12.4	13.4	11.4	14.2	11.6
Digestible Energy	kcal/kg	3197	3160	3197	3160	3194	3160
Lysine	%	0.65	0.65	0.59	0.58	0.56	0.56
<i>Second trial</i>							
Crude protein	%	13.7	9.3	13.2	9.2	12.3	9.1
Digestible Energy	kcal/kg	3197	3159	3197	3156	3194	3152
Lysine	%	0.64	0.64	0.59	0.6	0.54	0.54

3. Results & Discussion

In the first trial (Table 2) a small decrease in A.D.G. was observed ($P < 0.01$) in the low-protein diet, due to a weight gain reduction during the first 28 trial days; in the second trial the kind of diet did not impair both in vivo and slaughtering performances. In both trials the low-protein diet gave rise to a decrease in N excretion and an improvement in yield of the ingested N (Table 2).

Table 2. Pig performance and N balance

<i>First trial</i>		Control	Low protein	Statistical significance
Pigs	n	77	76	
Starting live weight	kg	98.6	98.6	Ns
Final live weight	kg	166.4	163.8	Ns
A.D.G. (91 days)	g	746	717	$P < 0.01$
F.C.R.		3.86	3.98	$P < 0.05$
Carcass yield	%	83.9	84.2	ns
Lean meat	%	49.7	49.6	ns
N balance				
N excreted (1)	kg	59.28	46.29	
N yield (2)	%	21.37	25.46	
<i>Second trial</i>		Control	Low protein	Statistical significance
Pigs	n	71	71	
Starting live weight	kg	102.8	102.8	ns
Final live weight	kg	161.7	160.2	ns
A.D.G. (76 days)	g	773	755	ns
F.C.R.		3.96	4.05	ns
Carcass yield	%	83.8	84.3	$P < 0.01$
Lean meat	%	49.8	49.7	ns
Nitrogen balance				
N excreted (1)	kg	44.54	27.67	
N yield (2)	%	22.86	31.68	

(1) Ingested N - Estimated N fixed in tissue

(2) Nitrogen fixed in tissue/Ingested N * 100

Ammonia emissions were also reduced (data not showed) in both trials. A reduction in slurry produced from animals fed different diets was also observed in both trials due to a reduction of voluntary water intake. A wide international literature shows that by lowering crude protein in the diet it is possible to obtain a reduction in N excretion in pigs slaughtered at 100-120 kg (e.g. Aarnink and Verstegen, 2007); in the heavy pig Piva et al. (1996) showed that the ingesta-excreta N balance may be improved by reducing dietary crude protein. In our trial a protein reduction did not impair the pig performances except for a A.D.G. reduction in the first trial probably due to an abrupt change of crude protein level at the start of the trial.

4. Conclusion

There is scope for improvement in use efficiency of N from feed in the Italian production of heavy pigs. Results from these trials will be used to scale up the systems at demonstrative level in the LIFE+ Project AQUA. coordinated by CRPA (<http://aqua.crpa.it>).

References

- Aarnink, A. J. A. and Verstegen, M. W. A. 2007. Nutrition, key factor to reduce environmental load from pig production. *Livestock Science* 109:194-203.
- Piva, G., Morlacchini, M., Prandini, A. and Fiorentini L. 1996. Performance and nitrogen balance in pigs fed with four ideal protein diets. In: *Proceedings of the 14th IPVS Congress, 7-10 July, Bologna, Italy*, p.417.

Nitrogen use efficiency on dairy farms

Mihailescu, E.^{a,b}, Murphy, P.^c, Casey, I.A.^b, Humphreys, J.^a

^aTeagasc, Animal & Grassland Research and Innovation Centre, Moorepark, Fermoy, Co. Cork, Rep. of Ireland

^bDepartment of Chemical and Life Sciences, Waterford Institute of Technology, Cork road campus, Waterford, Co. Waterford, Rep. of Ireland

^cTeagasc, Johnstown Castle, Co. Wexford, Rep. of Ireland

1. Background & Objectives

The Nitrates Directive regulations were implemented in August 2006 in Ireland under Statutory Instrument (SI) 378. These regulations limit the stocking densities and curtail the use of nitrogen (N) on farms. The objective of this study was to examine N balances and N use efficiencies on dairy farms following the implementation of the nitrates regulations under statutory instruments (SI 378, 2006; SI 101, 2009; SI 610, 2010).

2. Materials & Methods

Twenty-one dairy farms located in the south and east of Ireland were surveyed on a monthly basis during year 2010. Stocking density was expressed as the quantity of N excreted by livestock using standard values from the SI relative to the area of the farm used for agricultural production. The N imports (chemical fertiliser, purchased concentrates, silage and livestock) and N exports (milk, livestock and silage sales) passing the farm-gate were quantified. Nitrogen imported in concentrate feed onto farms was calculated by multiplying the total quantity of concentrate fed by its protein concentration divided by 6.25. The N content of imported and exported silage was calculated by dividing its protein concentration by 6.25 (McDonald et al., 1995). Nitrogen in milk exported from farms was calculated by dividing milk protein concentration by 6.39. Nitrogen exported in livestock leaving the farms was calculated by estimating the total live weight of the livestock sold (or died) from the farms and multiplying by 0.029 for calves and 0.024 for older animals (ARC, 1994). All N imports and N exports were expressed relative to the utilised agricultural area. The farm-gate balance was the difference between N imports and N exports, whereas N use efficiency was calculated as the ratio between N exports and N imports.

3. Results & Discussion

The mean stocking rate was equivalent to 183 kg ha⁻¹ (s.d. 31.6) of organic N. Dairy livestock was 72% of total livestock on farms. The farm-gate balance (kg N ha⁻¹) ranged from 73 to 285 with a mean of 196 (s.d. 62.6). Nitrogen use efficiency ranged from 16% to 43% with a mean of 28% (s.d. 5.71) (Figure 1). The mean stocking density (kg organic N ha⁻¹) was not significantly different ($P > 0.05$) than in earlier similar studies conducted on Irish dairy farms between 2003 and 2006 (Treacy et al., 2008) and in 1997 (Mounsey et al., 1998); 183 kg N ha⁻¹ (s.e. 6.75) in the current study, 202 kg N ha⁻¹ (s.e. 6.75) between 2003 and 2006 and 190 kg N ha⁻¹ (s.e. 8.93) in 1997. However, the proportion of dairy livestock (72% of total livestock) on farms in the present study was higher than previous studies (approximately 64%). This indicates that the dairy farmers in the current study were more specialized than in the previous studies. This is in line with national trend towards increased specialisation on dairy farms (Hennessy et al., 2010). The mean N surplus in the present study (196 kg N ha⁻¹) was lower than found by Treacy et al. (2008) (244 kg N ha⁻¹) and Mounsey et al. (1998) (304 kg N ha⁻¹). The mean N use efficiency in the current study (28%) was substantially higher than Treacy et al. (2008) (19.5%) and Mounsey et al. (1998) (17%).

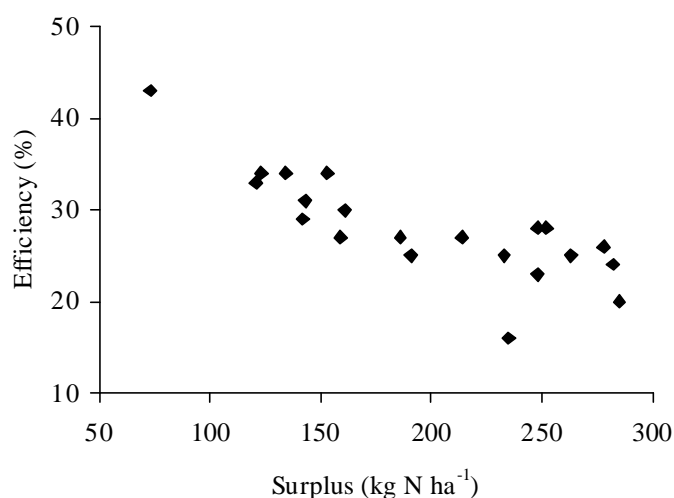

Figure 1. N use efficiencies relative to N surpluses on 21 Irish dairy farms in 2010

4. Conclusions

The mean N surplus was lower and N use efficiency was much higher than similar previous studies in Ireland indicating that there has been improvement in N use efficiency on dairy farms after implementation of Nitrates Regulations.

Acknowledgements

The authors acknowledge financial support from the ERDF Interreg IVB Dairyman project and the Teagasc Walsh Fellowship Scheme.

References

- ARC (Agricultural Research Council). 1994. The nutrient requirements of ruminant livestock. Technical review by an Agricultural Research Council Working Party. CAB International, Oxon, UK.
- Hennessy, T., Moran, B., Kinsella, A., and Quinlan, G. 2011. Teagasc National Farm Survey 2010. Athenry, Ireland, Teagasc.
- McDonald, P., Edwards, R.A., Greenhalgh, J.F.D. and Morgan, C.A. 1995. Animal Nutrition (5th edition). Prentice Hall, UK.
- Mounsey, J., Sheehy, J., Carton, O.T. and O'Toole, P. 1998. Nutrient management planning on Irish dairy farms. End of project report, ARMIS 4347, Teagasc, Dublin.
- S.I. (Statutory Instrument) No. 378 of 2006. European Communities (Good Agricultural Practice for Protection of Waters) Regulations 2006, The Stationary Office, Dublin, 49 pages.
- S.I. (Statutory Instrument) No. 101 of 2009. European Communities (Good Agricultural Practice for Protection of Waters) Regulations 2009, The Stationary Office, Dublin, 49 pages.
- S.I. (Statutory Instrument) No. 610 of 2010. European Communities (Good Agricultural Practice for Protection of Waters) Regulations 2010, The Stationary Office, Dublin, 53 pages.
- Treacy, M., Humphreys, J., Mc Namara, K., Browne, R. and Watson, C.J. 2008. Farm-gate nitrogen balances on intensive dairy farms in the south-west of Ireland, Irish Journal of Agricultural and Food Research 47, 105-117.

Nitrous oxide emission determining factors for a clay soil in Sweden

Nylinder, J.^a, Kasimir Klemedtsson, Å.^a, Stenberg, M.^b

^aDepartment of Earth sciences, University of Gothenburg.

^bRural Economy and Agricultural Society of Skaraborg and Division of precision agriculture, Department of soil sciences, SLU.

1. Background & Objectives

Nitrous oxide (N₂O) emission is inevitable whenever cultivating soil. For N₂O estimations the IPCC emission factors are often used which is a simplification sometimes needed, but for more detailed analysis many other factors have been found important for the degree of emission. In the agricultural system not only fertiliser or other additions are the cause for emissions, also soil disturbance activities can increase nitrogen (N) mineralisation which deliver N to both plants and microbial communities. Poor crop establishment or N surplus increase the risk of both N₂O emissions and N leaching. More reliable estimation methods are needed than what we found in an earlier study on estimating emission due to biofuel production where no estimation method like the IPCC or others were able to predict the emission (Kasimir-Klemedtsson and Smith, 2011). The aim in this project is to identify soil and management factors influencing the N₂O emission from clay soils, representative for Swedish agricultural conditions. Better abilities to estimate emissions based on understanding of the whole agricultural and soil system may guide us to crops and management having low emissions and give more detailed calculation methods.

2. Materials & Methods

We examined the effect of management influences on the emissions using a mechanistic process-based model, the CoupModel (Jansson and Karlberg, 2004), and data from two organic crop rotation sequences; field beans-spring wheat and green manure-winter rye. In this study the source data was collected from Logården (west Sweden), where three crop production systems, organic, integrated and conventional farming, have been managed continuously since 1991. Emissions of N₂O were measured by the static chamber method where sampling was carried out every second week between 2004 and 2007. During these years, also nitrate leaching and water discharge was measured every day together with occasional measurements of soil N, N in grain and soil water content.

3. Results & Discussion

In an earlier study by Nylinder et al. (2011) key soil processes, controlling N₂O production and emission from two organic fields, were found to be crop N uptake, nitrification, denitrification and also abiotic parameters. A recent simulation of one of the integrated fields (2004-2007) selecting an ensemble of runs, based on measured plant and soil N and total N₂O emission, did show important variables for N₂O emission to be; total soil nitrate content, plant N uptake and leaching of nitrate (Figure 1). It is obvious that the dynamics of soil nitrate is partly controlled by plant N uptake and leaching of nitrate (Figure 1). This is important knowledge as a basis to further investigation of soil disturbances by ploughing and compaction which we will show simulation results of at this workshop.

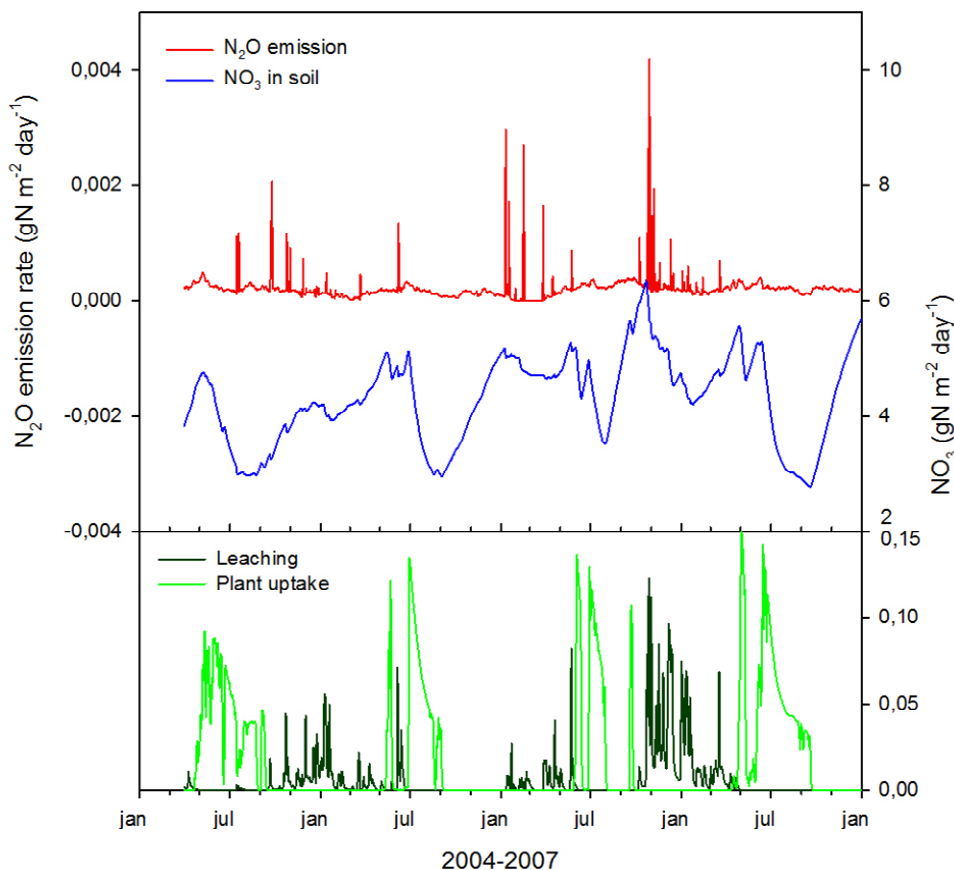

Figure 1. Simulated N₂O emission, soil nitrate content, nitrate leaching and nitrate uptake by plant from an integrated crop rotation field at Logården, 2004-2007.

4. Conclusion

By the CoupModel simulation it is possible to find influencing factors like soil nitrate content which, in as in this study, fluctuate over time. We will further investigate and present both ploughing and compaction effects on soil properties to find possible connections to N₂O emission.

References

- IPCC. 2006. N₂O emission from managed soils, in: Guidelines for National Greenhouse Gas Inventories, Vol. 4: agriculture, Forestry and Other Land Use, Chapter 11, edited by: Eggleston, H. S., Buendia, L., Miwa, K., Ngara T., Tanabe K., IGES, Hayama, Japan, 2006. Jungkunst, H. F., Freibauer
- Kasimir Klemetsson, Å. and Smith, K.A. 2011. The significance of nitrous oxide emission from biofuel crops on arable land: a Swedish perspective. *Biogeoscience* 8, 3581-3591.
- Nylinder, J., Stenberg, M., Jansson, P-E., Kasimir Klemetsson, Å., Weslien, P. and Klemetsson, L. 2011. Modelling uncertainty for nitrate leaching and nitrous oxide emissions based on a Swedish field experiment with organic crop rotation, *Agriculture, Ecosystem and Environment* 141, 167-183.
- Jansson, P.E. and Karlberg, L. 2004. Coupled heat and mass transfer model for soil-plant-atmosphere systems TRITA-LWR report 3087. Royal Institute of Technology, Department of Land and Water Resources Engineering Stockholm, Sweden. <http://www2.lwr.kth.se/CoupModel/index.html>

Performance of nitrogen fertilizer rates for winter oilseed rape

Ruža, A.^a, Gaile, Z.^a, Balodis, O.^b, Kreita, D.^a, Katamadze, M.^a

^aLatvia University of Agriculture

^bLatvia University of Agriculture, Research and Study Farm 'Vecauce'

1. Background & Objectives

Nitrogen as a critical nutrient element for winter oilseed rape is investigated quite frequently in Europe. Adjustment of N-fertilizer strategies becomes a more and more important factor as soil conditions, water availability and temperature influence plant growth and yield of cultivars. Different important courses in nitrogen utilization had been discussed in workshops, such as influence of environmental factors on plant growth and N-efficiency, integrated N-management strategies and further crop management practices combined with nitrogen provision (Rathe et al., 2006). Different experiments across Europe with similar themes like such as the effect of nitrogen fertilizer on yield and yield formation in winter oilseed rape show a tendency of higher yielding types of winter oilseed rape to respond typically to more N fertilizer (Wójtowicz et al., 1999). The aim of our trials was to determine indicators of the nitrogen fertilizer utilization for different nitrogen rates depending on specific year in variable meteorological conditions.

2. Materials & Methods

Field trials (starting in 2009-2011) with winter oilseed rape (*Brassica napus* ssp. *oleifera*) cultivar 'Catalina' were conducted in the Research and Study farms 'Vecauce' and 'Pēterlauki' of the Latvia University of Agriculture. Nitrogen fertilizer rates used were: 1. N₀P₀K₀ - check, 2. PK background, the following with a step N₃₀ to N₂₁₀ kg ha⁻¹. Seeds and straw were analyzed. Outcome, plant nutrient balance and utilization coefficients were calculated. Total N was determined by the Kjeldahl method. Nitrogen outcome was calculated based on total nitrogen content in seeds and straw. Apparent recovery fraction (ARF) for nitrogen was calculated using (1) formula (Montemurro et al., 2007):

$$ARF = \frac{(N_x - N_c)}{N_d} \quad (1)$$

Where N_x – N uptake at N_x, kg ha⁻¹; N_c – N uptake at control, kg ha⁻¹; N_d – dose of nitrogen, kg ha⁻¹.

3. Results & Discussion

The seed yield on average was within 2.0 t ha⁻¹ to 4.7 t ha⁻¹ (Figure 1). High seed yield - 5.34 t ha⁻¹ was obtained with nitrogen fertilizer rate N₁₅₀ at 'Pēterlauki' in 2009. The highest seed yields were achieved in variants N₁₂₀ or N₁₅₀ in all trial years; higher nitrogen fertilizer treatments did not increase seed yield significantly (P<0.05), with only total N content in seeds increasing in treatments with nitrogen fertilizer up to N₁₈₀. Total nitrogen content (TNC) in straw increased proportionally as nitrogen rates increased from 0.67 % in the control to 0.96% in N₂₁₀ - consequently total outcome of nitrogen per unit increased as a higher step of the fertilizer rate was used.

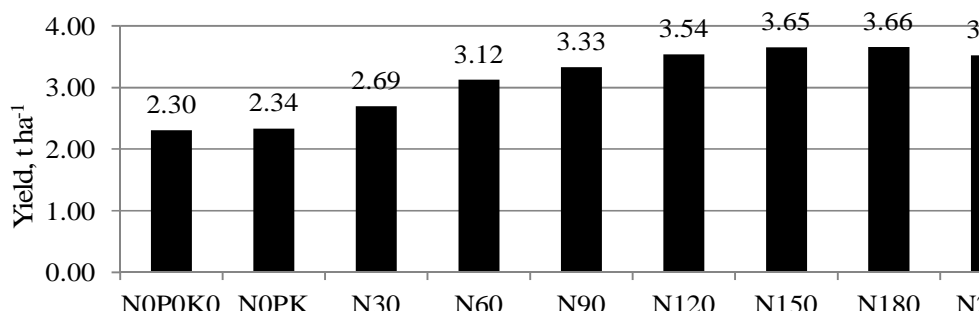

Figure 1. Average seed yield depending on nitrogen fertilizer rates

Total outcome of nitrogen with total plant mass was twice as much in fertilizer treatment N₂₁₀ than in check. Apparent recovery fraction for nitrogen in all fertilizer rates, except N₃₀, was above 0.40 with the highest result in rate N₁₂₀, but the result was different according to years and was within 0.35 to 0.90 in higher yielding rates (N₁₂₀ and N₁₅₀).

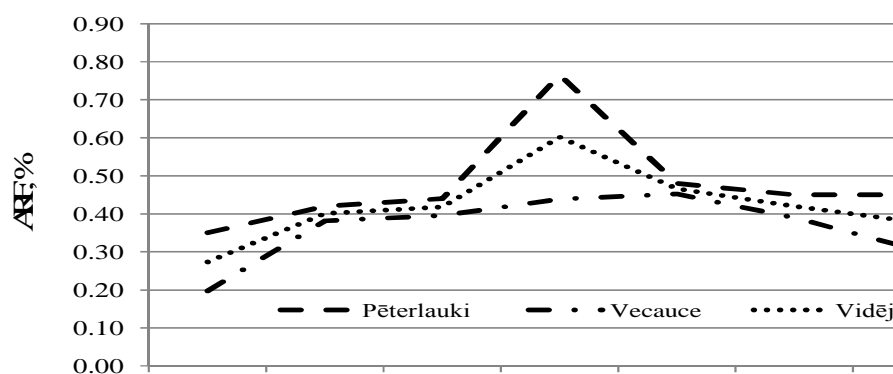

Figure 2. Average apparent recovery fraction for nitrogen depending on N rates and location of trial sites.

4. Conclusions

Seed yields of winter oilseed rape increased with increasing nitrogen fertilizer rates up to N₁₂₀₋₁₅₀ kg ha⁻¹. Further increases in fertilizer rates did not give significant ($p < 0.05$) seed yield increase. AFR is dependent on meteorological conditions in specific years and locations of trial sites.

References

- Montemurro, F., Convertini, G. and Ferri, D. 2007. Nitrogen application in winter wheat grown in Mediterranean Conditions: Effects on nitrogen uptake, utilization efficiency, and soil nitrogen deficit. *Journal of Plant Nutrition*, vol 30 (10), 1681-1703.
- Rathke, G.-W., Behrens, T. and Diepenbrock, W. 2006. Integrated nitrogen management strategies to improve seed yield, oil content and nitrogen efficiency of winter oilseed rape (*Brassica napus* L.): A review. *Agriculture, Ecosystems and Environment* 117, 80-108.
- Wójtowicz, M., Wielebski, F. and Krzymański, J. 1999. Yield structure of double low winter oilseed rape (*Brassica napus* L.) varieties in different environmental conditions. *Proceedings of 10th International Rape Congress, Canberra, Australia, 1999*. Available in www.regional.org.au/au/gcirc/index/references.htm

Prediction of nitrous oxide emissions from Irish arable lands using the ECOSSE model

M.I. Khalil^{a,b}, M. Richards^c, M. Abdalla^d, P. O'Brien^a, J. U. Smith^c, P. Smith^c and C. Müller^b

^aClimate Change Research Programme, Environmental Protection Agency, Wexford, Ireland (e-mail: i.khalil@epa.ie).

^bSchool of Biology and Environmental Science, University College Dublin, Belfield, Dublin 4, Ireland.

^cInstitute of Biological & Environmental Sciences, University of Aberdeen, Scotland, United Kingdom.

^dSchool of Botany, Trinity College Dublin, Dublin 2, Ireland.

1. Background & Objectives

Agriculture and associated land-use changes have large impacts on carbon (C) and nitrogen (N) cycling in soil systems and contribute about one-third of global greenhouse gas (GHG) emissions to the atmosphere. In the Republic of Ireland, agricultural activity is estimated to be responsible for 30% of the anthropogenic GHG emissions (McGettigan et al., 2010) and agricultural emissions remain a key component of the 20% reduction required by 2020. Reduction in the uncertainty in estimates of GHG emissions is a current research focus. This is particularly important for nitrous oxide (N₂O) because it has a greater radiative forcing potential and so errors in estimates have a greater impact than for methane (CH₄) and carbon dioxide (CO₂). Process-based modelling could greatly enhance the accuracy of estimates so improving national inventories. Our aim is to evaluate estimates of N₂O emissions from agricultural land provided by a process-based model, allowing accuracy of reporting to be quantified, and selection of mitigation options to be improved.

2. Materials & Methods

Two years of measured (seasonal) datasets for N₂O emissions were used to evaluate the ECOSSE model (Estimating Carbon in Organic Soils - Sequestration and Emissions). This is a multi-pool dynamic simulation model (Smith et al., 2010) based on the concepts of the RothC and SUNDIAL models. It has a number of advantages compared to other models, including limited meteorological and soil data requirements (e.g. soil water, plant inputs, nutrient applications, timing of managements). It can simulate the impacts of land-use, management and climate change on C and N emissions and stocks (Khalil et al., 2011) for both mineral and organic soils at a range of scales.

The experiment was carried out at a conventionally tilled (22 cm) arable site (spring barley - a major cereal crop) located in Oak Park, Carlow (52°86' N - 6°54' W). Details of the experiment are given by Abdalla et al. (2009). The soil was a sandy loam with a pH of 7.4 and a mean organic C and N content at 15 cm of 19.4 and 1.9 g kg⁻¹ soil, respectively. During the crop growth period (2004 and 2005), three different N fertilizer rates (0, 70-79 and 140-159 kg N ha⁻¹) were applied as calcium ammonium nitrate. The control was unfertilized from 2003 but the whole field had received 140-160 kg N ha⁻¹ before 2003. Full daily weather records and details of cropping and land management practices were included. The ECOSSE model was run to predict N₂O flux response to N fertilizer levels and the model performance was evaluated statistically.

3. Results & Discussion

The modelled responses of N₂O fluxes were found to be consistent with the two-year measured values (Fig. 1). The bias in the total difference between measured and the corresponding modelled N₂O fluxes were large due to the impact of a single unexpected measurement. In the control, the correlation coefficient (*r*) was poor (0.02) and root mean square error (*RMSE*) was high (43.6 g N ha⁻¹ d⁻¹), indicating poor performance of the model in describing N₂O emissions. In the fertilized fields, significant (*p*<0.01) correlation between modelled and measured N₂O flux was observed, with *r* of 0.54-0.60 and *RMSE* of 18.6-20.8 g N ha⁻¹ d⁻¹. The *RMSE* values suggest that this model

predicts N₂O emissions well at medium to high N rates, in line with the findings from the more complex and data demanding DeNitrification-DeCompostion (DNDC) model (Abdalla et al., 2009).

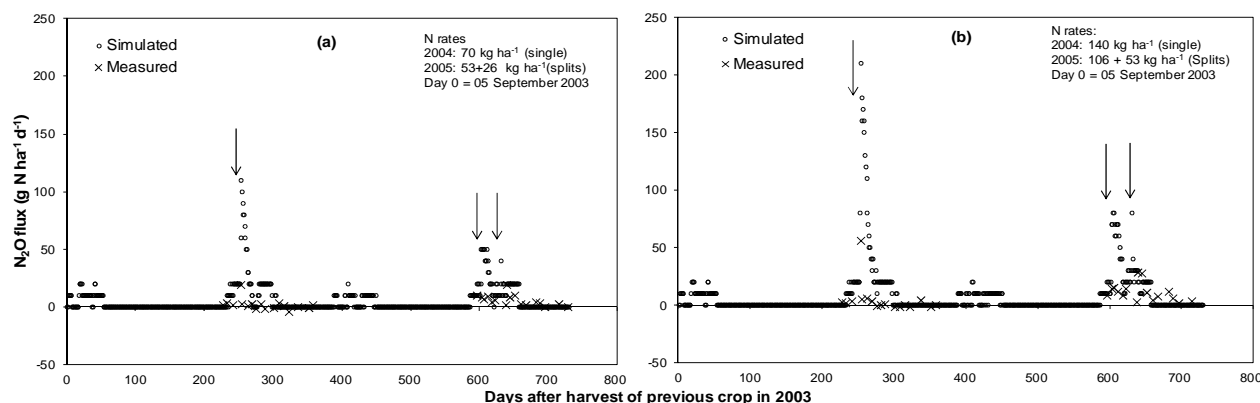

Figure 1. Measured and simulated N₂O fluxes as influenced by N fertilizer rates applied (arrows) to spring barley.

Irrespective of N fertilizer rates, the ECOSSE model somewhat overestimated seasonal total N₂O fluxes compared to the measured values, similar to the simulations of the unfertilized control using DNDC (Abdalla et al., 2009). The measured seasonal N₂O losses were 0.41 and 0.50% of the N applied at rates of 70-79 and 140-159 kg ha⁻¹, respectively. The corresponding losses were 34 and 22% lower than reported by Abdalla et al. (2009), which is probably due to the differences in integration method. The integration of simulated values for each date when measurements were taken provided seasonal N₂O losses of 0.69 and 1.11% of the applied N, suggesting an increase by 70-123% of the measured values. This could be due to missed emissions associated with the sporadic timing of measurements (2-15 day intervals), implying that intensive measurements following fertilizer application and rainfall are required to more fully evaluate model performance. The corresponding simulated N₂O emission factors obtained by summing the modelled daily fluxes over the year were 0.49 and 0.62%, which more closely matches the measured seasonal values.

4. Conclusion

The ECOSSE model predicts N₂O emission factors with accuracy similar to the predictions of the more data-demanding DNDC model. Improvements to ECOSSE to reduce overestimated emissions, particularly at lower N rates, are required. Results suggest that the ECOSSE model can reliably be used to estimate N₂O emissions from arable fields. However, further analyses are needed to fully determine the uncertainty in the estimates across all land-use and soil types under Irish conditions.

References

- Abdalla, M., Wattenbach, M., Smith, P., Ambus, P., Jones, M. and Williams, M. 2009. Application of the DNDC model to predict emissions of N₂O from Irish agriculture. *Geoderma* 151, 327-337.
- Khalil, M.I., Smith, J.U., Abdalla, M., O'Brien, P., Smith, P. and Müller, C. 2011. Predicting coupled emissions of N₂O, CO₂ and CH₄ from arable fields in Ireland using the ECOSSE model. In: *Proceedings of the American Geophysical Union Fall Meeting, 05-09 December 2011, San Francisco, CA, USA. B51H-0502.*
- McGettigan, M., Duffy, P., Hyde, B., Hanley, E., O'Brien, P., Ponzi J. and Black, K. 2010. National Inventory Report 2010: Greenhouse Gas Emissions 1990-2008. Reported to the United Nations Framework Convention on Climate Change. Environmental Protection Agency, Ireland. 364 pp.
- Smith, J., Gottschalk, P., Bellarby, J. et al. 2010. Estimating changes in national soil carbon stocks using ECOSSE – a new model that includes upland organic soils. Part I. Model description and uncertainty in national scale simulations of Scotland. *Climate Research* 45, 179-192.

Reducing N inputs and surpluses in baking wheat production by modifying the valuation system – an assessment of feasibility and potential in Germany

Techen, A.-K., Osterburg, B.

Institute of Rural Studies, Johann Heinrich von Thünen-Institut (vTI), Federal Research Institute for Rural Areas, Forestry and Fisheries, Bundesallee 50, 38116 Braunschweig, Germany

1. Background & Objectives

The prices that farmers receive for their wheat depend on the baking quality. The baking quality is not easy to measure. Thus an indicator is used that can be assessed very quickly, namely the crude protein (XP) content. In Germany, the XP content of bread wheat is $\geq 12\%$ while for baking wheat it is $\geq 13\%$.

Due to this system of quality assessment, farmers have an incentive to have high XP contents which can be achieved by additional N fertilizer input in the late stage of plant growth.

Research findings show that high baking qualities of wheat can be reached with lower XP contents (e.g. Obenauf, 2009; Seling, 2010), using new wheat varieties. However, this has not led to a change of pricing and thus not of management and N input either.

The aim of this paper is to show the potential of a new quality assessment allowing for decreased N input and N surplus in wheat production, using the example of Germany. It investigates what the obstacles are for putting this new approach into practice, and how they could be overcome.

2. Materials & Methods

Information on the baking quality of different varieties at certain XP contents has been drawn from the literature, complemented by expert interviews. The emission reduction potential on a per ha basis was calculated by information on plant uptake and fertilization practices acknowledging field trials, fertilization recommendations and assumptions from experts. The resulting assumptions on reduction potentials range from 20 kg N ha⁻¹ reduced input and 40 % surplus at the one far end to 40 kg N ha⁻¹ reduced input and 60 % surplus at the other end. A simplification was made by assuming that all bread and baking wheat is fertilized with mineral fertilizer. The reduction potential for Germany was calculated based on statistical information on production of different wheat classes (Seling et al. 2007-2010). Further, the potential of saving greenhouse gas (GHG) emissions was calculated as the reduction based on reduced application of mineral N fertiliser according to IPCC 1996¹ and the GHG emissions arising from production of 1 kg of mineral N fertiliser and transport to the farm. Further information on the feasibility of a new approach for wheat quality assessment was gained by conducting a literature review and expert interviews.

3. Results & Discussion

The emission reduction potentials are displayed in Table 1. The amounts of mineral fertilizer N which could be saved in Germany range between 46,630 and 93,270 t N. This corresponds to around 3 to 6 % of purchased mineral fertilizer N. Accordingly, the reduction of direct GHG emissions from N fertilization (284 kt to 569 kt CO₂-eq.) corresponds to those 3 to 6 % of direct emissions from all mineral fertilizers applied in Germany. The impact of N losses to the environment, mainly as nitrate to water bodies and ammonia to the atmosphere could be reduced by 18,650 to 55,960 t N altogether. This is up to 3.3 % of total N surplus in Germany.

¹ Emission factors: 5 kg CO₂-eq./kg N for direct emissions, 3.9 kg CO₂-eq./kg N for indirect emissions and 7.5 kg CO₂-eq./kg N for emissions from mean N fertiliser production (database: <http://www.probas.umweltbundesamt.de>).

Table 1. Estimated emission reduction potentials for reducing the XP content of bread and baking wheat in Germany (the range is based on the assumptions shown in section 2).

	N-input (t)	N-surplus (t)	CO ₂ -eq. (t)	Direct CO ₂ -eq. (t)
Minimum	46,630	18,650	816,080	284,460
Maximum	93,270	55,960	1,632,170	568,930

The reduction of these amounts of fertilizer N would lead to a corresponding decrease of production costs, namely around 42 to 83 million € year⁻¹ in Germany based on average fertilizer prices in the years 2006/07 to 2008/09. Additionally, it would reduce the farmers' risk: the N applied in May or June to increase XP content cannot always be taken up by the plants. Especially with increased summer droughts this is a problem that leads to cost inefficacy and N-emissions. Interviewed farmers' representatives thus said they would appreciate a change of the wheat quality assessment. However, the direct measurement of baking quality is costly and not quick enough for quality management in the trade system. The wheat variety is a feasible indicator to complement the XP indicator. For this, at least for German conditions, there is no fast enough variety determination method available or even in sight. This is why an elaborated logistical and institutional system to track wheat varieties in the supply chain would have to be developed in order to allow for an innovative N-reduced wheat production system. The trade representatives are very sceptical concerning such a conversion due to the involved investment and transaction costs. From an economic and environmental point of view the aggregated costs of conversion are likely to be lower than the aggregated costs of not changing the system. A change, however, would require negotiations and agreements between different actors of the supply chain. All actors would have to acknowledge that the benefits and costs have to be shared along the value chain. For example, farmers may need to commit themselves to a certification system based on voluntary disclosure of delivered wheat varieties connected to sanctioning procedures for false statements revealed with spot checks. After all, currently, there are not enough incentives for the actors to seriously consider a change. Government intervention or consumer demand could create incentives to enable these innovations in quality wheat production.

4. Conclusion

In bread and baking wheat production, a relevant amount of fertilizer N is applied to the soils in the late growth stage. This results in high N-surpluses, which could be avoided by using new wheat varieties of high baking qualities, hence leading to reduced N losses to the environment and more cost-efficient fertilization. However, the implementation of a new wheat quality assessment would require an investment in negotiation and conversion of the trade system for which incentives have to be created.

References

- Obenauf U. 2009. Qualität neu bewerten!, DLG-Mitteilungen 6/2009, 22-24.
- Seling S. and Lindhauer M.G. 2007. Die Qualität der deutschen Weizenernte. Teil 1: Quantitatives und qualitatives Ergebnis in Bund und Ländern, Mühle + Mischfutter 143, 692-704.
- Seling S. 2010. Bedeutung des Proteingehaltes von Backweizen aus Sicht der Wissenschaft, Getreidetechnologie 64, 103-110.
- Seling S. and Lindhauer M.G. 2008. Die Qualität der deutschen Weizenernte 2008. Teil 1: Quantitatives und qualitatives Ergebnis in Bund und Ländern, Mühle + Mischfutter 145, 683-695.
- Seling S., Schwake-Anduschus C. and Lindhauer M.G. 2009. Die Qualität der deutschen Weizenernte 2009. Teil 1: Quantitatives und qualitatives Ergebnis in Bund und Ländern, Mühle + Mischfutter 146, 672-681.
- Seling S., Schwake-Anduschus C. and Lindhauer M.G. 2010. Die Qualität der deutschen Weizenernte 2010. Teil 1: Quantitatives und qualitatives Ergebnis in Bund und Ländern. Mühle + Mischfutter 147, 626-636.

Relationship between management, economics and environmental quality on Dutch arable farms

Daatselaar, C.H.G.^a, Prins, H.^a, Reijls, J.W.^a

^aAgricultural Economics Research Institute (LEI), part of Wageningen UR, The Hague, the Netherlands.

1. Background & Objectives

The growth of crops on arable farms is inevitably associated with losses of nitrogen (N) to the environment. These losses can compromise the quality of air, groundwater and surface water. Actual losses of nitrogen in the field are determined by many factors in which the management decisions of the farmer play a decisive role, as demonstrated by Daatselaar et al. (2010) on dairy farms. For a sustainable arable farming sector, the economic performance of the farms is crucial. Therefore, it is important to know whether farmers can reduce N-soil surpluses on and nitrate concentration under their farms with the least possible negative effects on income. If changes to farm management practices result in a decrease in nitrate concentration, without hampering the economic performance, then farmers will be more willing to adapt their management. The objective of this paper is to estimate the relationship on Dutch arable farms between farm management, nitrogen soil surplus and nitrate concentration in groundwater or drain water.

2. Materials & Methods

For the purpose of this study, data of 140 arable farms from the Dutch Minerals Policy Monitoring Program (LMM) were used. Data were obtained from the Dutch Farm Accountancy Data Network (FADN) except the nitrate concentration which was measured by the National Institute for Public Health and the Environment (RIVM). The analysis of the N-soil surpluses and the economic results concerned 242 observations on sandy soils in the period 1991-2009 and 223 observations on clay soils in the period 1996-2009. The number of observations (years) per farm varied from 1 to 11, so the available dataset was an unbalanced panel. The N-soil surplus was calculated as the sum of the N surplus at the farm gate level and the N input from deposition and fixation minus gaseous N emission (Fraters et al., 2007). Various possible explanatory factors were selected based on literature review, with specific attention to recent changes in legislation (for instance the ban on the application of manure in autumn and winter). To determine the explanatory factors for N-soil surplus, gross margin and nitrate concentration linear regression analysis was used. Because of the unbalanced data, the Fixed Effects (FE) model was applied (Baltagi, 1998) The FE-model only uses the variation within the farms over years (and not the variation between farms), which is more useful to identify possibilities for farmers to adapt their management.

3. Results & Discussion

Results for the sandy soils are presented in Table 1. This table does not show the complete model but only the explanatory factors where $P < 0.05$ for the N-soil surplus per ha, the gross margin per ha or the nitrate concentration are shown. R^2 for N-soil surplus per ha is 0.76, for gross margin per ha 0.24 and for nitrate concentration 0.12. With crop yield level above average, arable farmers achieve both lower N-soil surpluses and higher gross margins. Lower levels of fertilizing result in lower N-soil surpluses but do not affect gross margins, under the express condition that all other explanatory factors do not change.

Table 1. Coefficients and their standard error (S.E.) of explanatory factors for N-soil surplus in kg/ha, gross margin in €/ha and nitrate concentration in groundwater in mg/l: regression results for Dutch arable farms on sandy soils over the period 1991-2009, estimated with a Fixed Effects-model (N=242).

Explanatory factor	N-soil surplus (kg ha ⁻¹)		Gross margin (€/ha)		Nitrate conc. (mg L ⁻¹)	
	Coeff.	S.E.	Coeff.	S.E.	Coeff.	S.E.
Farm size (Dutch Size Units)	-0.0746	0.1041	4.2430	1.3251**	0.0323	0.1586
Share sugar beets in cropping plan (%)	-0.4432	0.4548	14.847	5.1271**	0.0466	0.6145
Artificial fertilizer (kg N/ha)	0.9598	0.0773***	-0.3171	0.8717	0.2097	0.1053**
Organic manure (kg N/ha)	0.8970	0.0465***	0.3980	0.5246	0.0984	0.0625
Index crop yield (average = 100)	-1.2822	0.2848**	12.017	3.2102***	0.0394	0.3836

* P<0.05 ** P<0.01, *** P<0.001

On sandy soils, larger farms and those with a higher % share of sugar beets in the cropping plan achieve a higher gross margin per ha. In the case of the nitrate concentration in groundwater under sandy soils only a higher level of artificial N-fertilizer slightly increases the nitrate concentration.

Table 2 shows results for arable farms on clay soils.

Table 2. Coefficients and their standard error (S.E.) of explanatory factors for N-soil surplus in kg ha⁻¹, gross margin in €/ha and nitrate concentration in drainwater in mg L⁻¹: regression results for Dutch arable farms on clay soils over the period 1991-2009, estimated with a Fixed Effects-model (N=223).

Explanatory factor	N-soil surplus (kg ha ⁻¹)		Gross margin (€/ha)		Nitrate conc. (mg L ⁻¹)	
	Coeff.	S.E.	Coeff.	S.E.	Coeff.	S.E.
Artificial fertilizer (kg N ha ⁻¹)	0.9624	0.0861***	1.0431	2.7717	0.1358	0.0725*
Organic manure (kg N ha ⁻¹)	0.8842	0.0458***	-0.3428	1.4750	0.0231	0.0385
Index crop yield (average = 100)	-0.9186	0.3567*	6.0486	11.476	0.0462	0.3024

* P<0.05 ** P<0.01, *** P<0.001

In the case of the N-soil surplus in kg per ha on clay soils the results are similar to the sandy soils. However this is not the case for the gross margin per ha as no significant (P<0.05) explanatory factors were found, not even for the level of the crop yield. It is hypothesised that a higher crop yield on clay soils goes together with lower prices per unit or higher costs. Concerning the nitrate concentration in drain water only a higher level of artificial N-fertilizer slightly increases the nitrate concentration on clay soils, just as on sandy soils.

4. Conclusion

This integrated approach of farm management, economics and environmental quality shows that Dutch arable farmers on both sandy and clay soils can reduce N-soil surpluses per ha by using less artificial fertilizer or organic manure without affecting the gross margin per ha. Important is the assumption of all other explanatory factors being equal which will often not be the case. Nitrate concentration can slightly decrease by less use of artificial N-fertilizer. For arable farms on clay soils that smaller use of artificial N-fertilizer can be enough to meet the EU-standards for nitrate concentration. For arable farms on sandy soils more stringent measures can be necessary because breaches of the EU-standards are higher than for arable farms on clay soils.

References

- Baltagi, B.H. 1998. Econometric analysis of panel data. 4th edition, Wiley
- Daatselaar, C.H.G., Doornewaard, G.J., Gardebroek, C., de Hoop, D.W. and Reijs, J.W. 2010. Bedrijfsvoering, economie en milieukwaliteit: hun onderlinge relaties bij melkveebedrijven (in Dutch with English summary). LEI, The Hague (NL), report 2010-053.

Replacing lime with gypsum as fertiliser filler in calcium ammonium nitrate (CAN): a strategy for minimising nitrogen losses to the environment

Bailey, J.S.

Agri-Food and Biosciences Institute, 18A Newforge Lane, Belfast, BT9 5PX, Northern Ireland

1. Background & Objectives

Calcium (Ca), when present in millimolar concentrations, has a stimulatory effect on a wide range of membrane-bound enzymes, including ATPase's, (Marschner, 1995), and there is evidence that this type of stimulation may promote nitrogen (N) uptake by plants. Pot experiments have demonstrated that replacing calcium carbonate (CaCO_3) with calcium sulphate (CaSO_4) (a much more soluble Ca salt) as fertiliser filler, considerably enhanced (>30%) the uptake of ^{15}N -labelled $\text{NO}_3\text{-N}$ by perennial ryegrass within the first two weeks of regrowth. Thereafter, because losses of $\text{NO}_3\text{-N}$ from pots by denitrification or leaching had been minimal, plants supplied with N fertilisers containing CaCO_3 or CaSO_4 filler, eventually recovered equal amounts of N from the soil solution (Kirkpatrick and Bailey, 2006). In field situations, though, where the potential for denitrification loss is often high, any improvement in NO_3^- uptake as a result of Ca stimulation of N absorption, however transient, might help to improve fertiliser N efficiency and thus prevent significant losses of N to the environment. To test this hypothesis, field trials were conducted at Hillsborough to investigate whether replacing some or all of the CaCO_3 filler in CAN with CaSO_4 , had the potential to significantly enhance N uptake and recovery by cut grassland swards.

2. Materials & Methods

Five CAN-based granulated N fertilisers were prepared by Kemira Agriculture UK. Each fertiliser contained 27% N as NH_4NO_3 , had fillers containing CaCO_3 and CaSO_4 in the following ratios (F1 - 100:0), (F2 - 75:25), (F3 - 50:50), (F4 - 25:75) and (F5 - 0:100), and contained between 0 and 12% SO_3 . Established forage grassland sites were selected at Terry's hill, for a two-year field trial in 2001 and 2002, and at Pantridge's, for a one year trial in 2003. The trial at Terry's Hill had a 5 x 3 factorial design with 5 fertilisers (F1-F5), three rates of N application: 50, 75 and 100 kg N ha⁻¹ cut⁻¹, and 5 replicates. The trial at Pantridge's, had a 3 x 2 design with just 3 fertilisers (F1, F3 and F5) and two rates of N application (75 and 100 kg N ha⁻¹ cut⁻¹), and 12 replicates. Plots, 6m x 2m in size, were laid out in fully randomized blocks on both sites. Fertiliser treatments were applied in early April for 1st cut crops (except at Terry's hill in 2001, when Foot and Mouth prevented access to the site), after 1st cut in May, and after 2nd cut in July. Basal dressings of potassium (K) and sulphur (S) were applied to provide annual rates of application of 95 kg K ha⁻¹ and 37.5 kg S ha⁻¹ at Terry's Hill (soil K index 3), and 135 kg K ha⁻¹ and 37.5 kg S ha⁻¹ at Pantridge's (soil K index 2). Phosphorus was not applied at either site as soil P indices were ≥ 3 . Plots were harvested using a plot harvester, and fresh yields determined. Sub-samples of herbage were collected, oven-dried, milled and chemically analysed to provide DM and nutrient yield data. All data were subjected to analyses of variance (ANOVA), and trends and interactions between treatments were tested using student's *t* test and with pooled standard errors from the ANOVA.

3. Results & Discussion

Overall, the results of the trials showed that replacing CaCO_3 with CaSO_4 as fertiliser filler never proved detrimental to N uptake or sward DM production and at various harvests significantly enhanced one or other or both of these yield parameters, thus demonstrating its potential as a strategy for improving fertiliser N efficiency and minimising N losses to the environment. Rather

than presenting results for all harvests at each site, only those harvests where fertiliser type (F) had a significant (or near significant $P < 0.07$) effect on DM or N yield will be considered. In 2001 (Terry's Hill), on average over all N rates, total (100%) replacement of CaCO_3 with CaSO_4 , as filler, significantly enhanced sward N yield, but not DM yield, at both 2nd and 3rd cuts (Table 1); but on plots receiving the lowest rate of N, it significantly enhanced both DM and N yields (by 16.6%) at 2nd cut (Figure 1a). In 2002, at 1st cut, replacing CaCO_3 with CaSO_4 , as filler, enhanced DM yield on plots fertilised with the intermediate N rate (75 kg N ha⁻¹ cut⁻¹), and produced appreciable (13.5%), albeit non-significant improvements, in N yield (Figure 1b). At Pantridge's, on average over all N rates, replacement of CaCO_3 with CaSO_4 , as filler, significantly enhanced N yield at 2nd cut (Table 2).

Table 1. Effect of replacing CaCO_3 with CaSO_4 , as filler, on sward N yields (mean of all N rates) at 2nd and 3rd cuts in 2001 (Terry's Hill).

Yield parameter	% CaSO_4 in filler					LSD ($P < 0.005$)
	0	25	50	75	100	
N yield cut 2 (kg ha ⁻¹)	84.2	85.8	88.4	84.4	92.6	6.12
N yield cut 3 (kg ha ⁻¹)	80.3	84.3	82.9	84.6	87.6	6.38

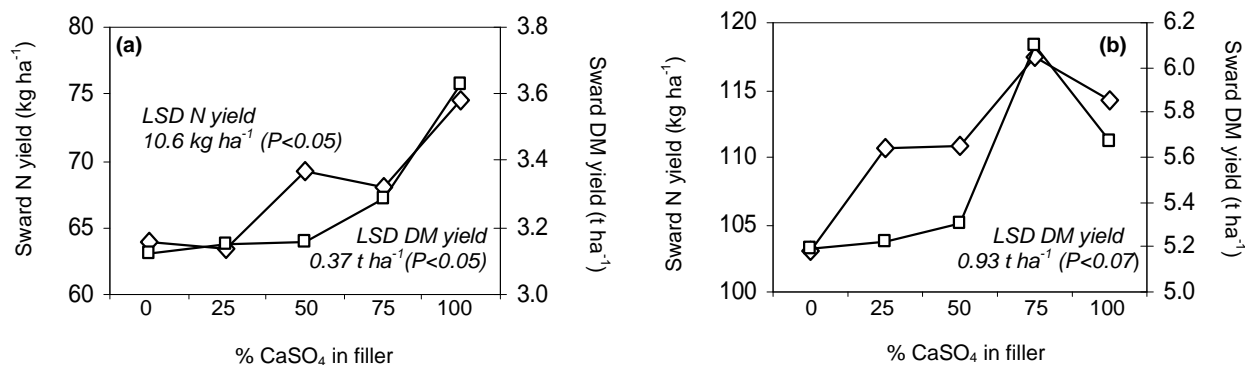

Figure 1. Effect of replacing CaCO_3 with CaSO_4 , as filler, on sward N (filled diamond) and DM (open square) yields at Terry's Hill on plots fertilised with (a) 50 kg N ha⁻¹ at 2nd cut 2001, and (b) with 75 kg N ha⁻¹ at 1st cut 2002.

Table 2. Effect of replacing CaCO_3 with CaSO_4 , as filler, on N yield (mean of all N rates) at cut 2, 2003 (Pantridge's).

Yield parameter	% CaSO_4 in filler			LSD ($P < 0.005$)
	0	50	100	
N yield cut 2 (kg ha ⁻¹)	74.7	73.6	80.0	4.96

The absence of N (and DM) yield responses to increased CaSO_4 concentrations in filler at other cuts is not unexpected, since such responses are only likely when conditions are conducive for N loss.

4. Conclusion

Replacement of all or most of the CaCO_3 in CAN with CaSO_4 can significantly improve fertiliser N efficiency and minimise N losses to the environment. CaSO_4 -modified CAN also provides a valuable supply of S for early and mid-season silage crops, which can be prone to S deficiency.

References

- Kirkpatrick, T. and Bailey, J.S. 2006. Calcium sulphate versus lime as fertiliser filler: effects on ammonium and nitrate uptake by perennial ryegrass. *Communications in Soil Science and Plant Analysis*, 37, 733-750.
- Marschner, H. 1995. *Mineral Nutrition of Higher Plants* (2nd Edition), Academic Press, Ltd, London, pp 484-498.

Response of a range of forage swards to slurry nitrogen

Dale, A.J.^a, Laidlaw, A.S.^b, Bailey, J.S.^c

Agri Food and Biosciences Institute (AFBI)^aHillsborough, Co Down, Northern Ireland BT26 6DR, ^bCrossnacreevy, Houston Road, Crossnacreevy, Co Down, Northern Ireland BT6 9SH, ^cNewforge, Belfast, Northern Ireland, BT9 5PX

1. Background & Objectives

Grass species vary in their response to nitrogen (N) fertiliser (Frame, 1991), but less is known about the responsiveness of different species to slurry N. In a study in the United States, the dry matter (DM) yield response to dairy slurry application was greater for tall fescue than for cocksfoot albeit N off take was highest for cocksfoot and so apparent N recovery was similar for both species (Cherney et al., 2002). Grass/legume swards tend to be less responsive to slurry N than grass swards (Lambe et al., 2005), largely because growth stimulation of grasses by slurry N leads to competition with the legumes and so the net effect on total forage production is lower than for non-legume forages or mixtures. Consequently, the type of grass or legume-based forage to which slurry is applied may have an impact on the efficiency of utilisation of nutrients applied. From a management perspective, such differences between forage types as regards their responsiveness to slurry, could affect the choice of grassland to which slurry is applied. The following experiment was therefore undertaken to determine the effect of forage type on slurry N off take and efficiency of utilisation in a simulated silage cutting regime over four years.

2. Materials & Methods

The trial was a slit plot design with slurry rate as the main plot factor and sward type as the sub-plot factor, with plots (112) 6.0 m x 1.5 m in size laid out in 4 replicate blocks in the autumn of 2004. The trial was conducted over the subsequent 4 years, 2005-2008. Slurry was applied by the trailing-shoe technique at an average annual rate of 0, 33.8 (Low), 60.0 (Medium) and 89.2 (High) m³ ha⁻¹. Across all slurry rates, 50% of the total annual application was applied in spring, and 25% applied after each of the first and second harvests. No other nutrients were applied during the four years of the trial. The seven sward types included two perennial ryegrass mixtures (diploid, PRG Dip, and tetraploid, PRG Tet), hybrid ryegrasses (Hyb RG), Italian ryegrass (Ital RG), low input mixture (LIM, comprising cocksfoot, perennial ryegrass, timothy and meadow fescue), perennial ryegrass/white clover (PRG WC) and red clover (RC).

Plots were harvested three times per annum, except in 2007, when four harvests were taken. The N content of herbage samples was determined using the Kjeldahl method, except in 2008, when the determinations were made by direct combustion using a Leco CN-2000 elemental analyzer. Annual DM response to slurry N was calculated from the difference between annual DM yield per slurry-treated plot and that of the corresponding forage receiving no slurry in that replicate, divided by the rate of slurry N applied. Apparent slurry N recovery was calculated similarly except difference in harvested N rather than in harvested DM was divided by the appropriate rate of slurry N applied. Data were analysed by analysis of variance on a split plot model using Genstat (Release 12.1)

3. Results & Discussion

Annual DM response to slurry N was significantly higher at the low slurry rate than at the two higher rates of application (Table 1a). The differences in response between sward types ($P < 0.001$) were due to the two legume-containing swards (PRG WC, RC) having a lower DM response to slurry application than the remaining grass-only swards (Table 1b).

Table 1. Annual response (kg DM harvested/kg slurry N applied), and apparent N recovery (kg N uptake in harvested herbage due to slurry/kg slurry N applied) per annum and for each application, all averaged over 4 years at: a) for three slurry rates, and b) for each sward type (no interactions were significant).

a) Slurry Rate	Low	Medium	High	Prob.	s.e.d.
Annual DM Yield Response	21.1	15.9	13.6	0.03	1.25
Annual Apparent N Recovery	0.35	0.25	0.25	0.057	0.038
Apparent N Recovery per Application					
1	0.49	0.32	0.30	0.017	0.050
2	0.15	0.13	0.14	0.882	0.034
3	0.44	0.31	0.30	0.056	0.050

b) Sward Type	PRG Dip	PRG Tet	Hyb RG	Ital RG	LIM	PRG WC	RC	Prob.	s.e.d
Annual DM Yield Response	20.4	21.1	21.4	19.2	20.0	9.0	6.3	<0.001	1.50
Annual Apparent N Recovery	0.36	0.39	0.34	0.26	0.40	0.14	0.08	<0.001	0.037
Apparent N Recovery per Application									
1	0.48	0.47	0.40	0.28	0.48	0.32	0.13	<0.001	0.057
2	0.16	0.21	0.24	0.19	0.24	-0.06	0.02	<0.001	0.033
3	0.43	0.50	0.46	0.30	0.51	0.15	0.09	<0.001	0.056

Apparent slurry N recovery declined significantly ($P=0.06$) with increasing slurry rate (Table 1a). The legume-containing swards had a lower ($P<0.001$) apparent N recovery than all the grass swards, with PRG-WC having a higher N recovery than RC. Among the all-grass swards, the apparent N recovery by Ital RG was the lowest, and that by LIM, the highest. Nitrogen recovery from the 1st spring slurry application was significantly higher at the lowest rate of slurry than at the other two rates, and over all rates, was significantly greater than that at the 2nd slurry application. On average over all three slurry application rates, N recovery from the 2nd application was only about 40% of that from the other two applications (Table 1a). Except at the 1st application, apparent recovery of N was lowest for slurry applied to legume-containing swards (Table 1b). At the first application in spring, the recovery of slurry N by PRG WC was as high as the recovery by Ital RG.

The poorer DM response to slurry N and the lower N recovery by legume swards compared to grass-only swards was due to both a reduction in legume content and a lower apparent N fixation per unit weight of harvested herbage when slurry was applied. The poor apparent N recoveries from 2nd slurry applications, was partly due to weather conditions favouring ammonia loss (Lalor and Schulte, 2008), but mainly to slow regrowth and low N uptake following a heavy first harvest.

4. Conclusion

To maximise use of slurry N, application to swards with high legume content and/or following heavy silage crops in early summer, should be avoided, unless other slurry nutrients are needed.

References

- Cherney, D.J.R., Cherney, J.H. and Mikhailova, E.A. 2002. Orchardgrass and tall fescue utilization of nitrogen from dairy manure and commercial fertilizer. *Agronomy Journal*, 94, 405-412.
- Frame, J. (1991) Herbage production and quality of a range of secondary grass species at 5 rates of fertiliser nitrogen application. *Grass and Forage Science*, 46, 139-151.
- Lalor, S. T. J. and Schulte, R. P. O (2008) Low-ammonia-emission application methods can increase the opportunity for application of cattle slurry to grassland in spring in Ireland. *Grass and Forage Science* 63, 531-544.
- Lamb, J.F.S., Russelle, M.P. and Schmitt, M.A. 2005. Alfalfa and reed canary grass response to midsummer manure application. *Crop Science*, 45, 2293-2300.

Temporal dynamics of soil N mineralization during an oilseed rape (*Brassica napus* L.) growth cycle in one season's growth under humid Mediterranean conditions

Villar, N.^a, Gallejones, P.^b, Castellón, A.^a, Besga, G.^a, Aizpurura, A.^a

^aNEIKER-Basque Institute for Agricultural Research and Development, Derio, Spain

^bBC3. Basque Centre for Climate Change. Bilbao, Spain

1. Background & Objectives

Rapeseed (*Brassica napus* L.) cultivation has recently increased, due to its demand for biodiesel. Rapeseed can accumulate N in its tissues during autumn (Malagoli et al., 2005), thus reducing N leaching during that season. In order to reduce N leaching, it is important to determine soil N mineralization and what can be done through the calculation of the N balance. There are many studies on oilseed rape but most have focused on the crop or the management of its residues (Hocking et al., 1997; Justes et al., 1999). Mineralization studies are mainly carried out under laboratory conditions (Sierra, 1997), and little is known about nitrogen balances in field. The aim of this work was to study the seasonal pattern of N mineralization throughout a whole year in a wheat-rapeseed rotation, with and without fertilization, in a humid Mediterranean region.

2. Materials & Methods

The study was conducted from August 23, 2006 (after the harvest of the previous wheat crop), along the whole growing cycle of rapeseed, until October 4, 2007 (before soil tillage previous to the following crop). Winter rapeseed (var. Standing) was sown on September 19, 2006 near Vitoria city (42° 49' N; 2° 30' W). The climate is Mediterranean humid with a mean annual temperature of 11,5 °C and a total rainfall of 779 mm. During the rapeseed growing cycle, two N treatments were applied: no nitrogen application (0N) and 180 kg N ha⁻¹ (180N) that was applied on two occasions (60 kg N ha⁻¹ at beginning of stem elongation, and 120 kg N ha⁻¹ at the beginning of inflorescence emergence). Oilseeds were harvested on July 18, 2007. Nitrogen balance was calculated as the difference between N outputs and inputs. Nitrogen outputs corresponded to: N absorbed by plants, N leached, N emitted and N_{min} (the later three were measured every fortnight or when rainfall was over 20-30 mm). Nitrogen inputs corresponded to atmospheric deposition, N applied, N_{min} at the beginning of each period and the N content in seeds at sowing. Mean N balance was calculated from the fortnightly balances among different periods. On the same sampling occasions, when N leached, N_{emitted} and N_{min} were measured, soil humidity was also recorded to obtain the percentage of soil pores filled with water (PPFW), using equation [1]

$$PPFW = \frac{H * BD}{1 - (BD - 2.65)} \quad \text{Where, H is soil humidity (\%)} \text{ and } BD \text{ is the bulk density (g cm}^{-3}\text{) [1]}$$

without stones.

3. Results & Discussion

Total N mineralization during the period of study was 70±22 kg N ha⁻¹ for 0N and 99±15 kg N ha⁻¹ for 180N treatments, but the difference was not significant. From the beginning of the experiment until stem elongation, mineralization was close to 0 for both treatments (Figure 1), due to low temperatures during winter (often below 5 °C). After both N applications, fertilized plots showed immobilization, which was higher after the second N application. Microorganisms compete with plants for the N applied (Nielsen and Jensen, 1986). Plots without N (0N) also experienced a reduction in mineralization after inflorescence emergence (from 0.5 to 0.1 kg N ha⁻¹ day⁻¹). This may have been due to the heavy rain in March which saturated soil pores, limiting N mineralization

(Sierra, 1997). From flowering to harvest (mean temperature above 15 °C), mineralization was the predominant process, and was higher in the fertilized plots (1.16 and 0.22 kg N ha⁻¹ for 180N and 0N, respectively). After harvest, during the summer drought, in both treatments mineralization declined.

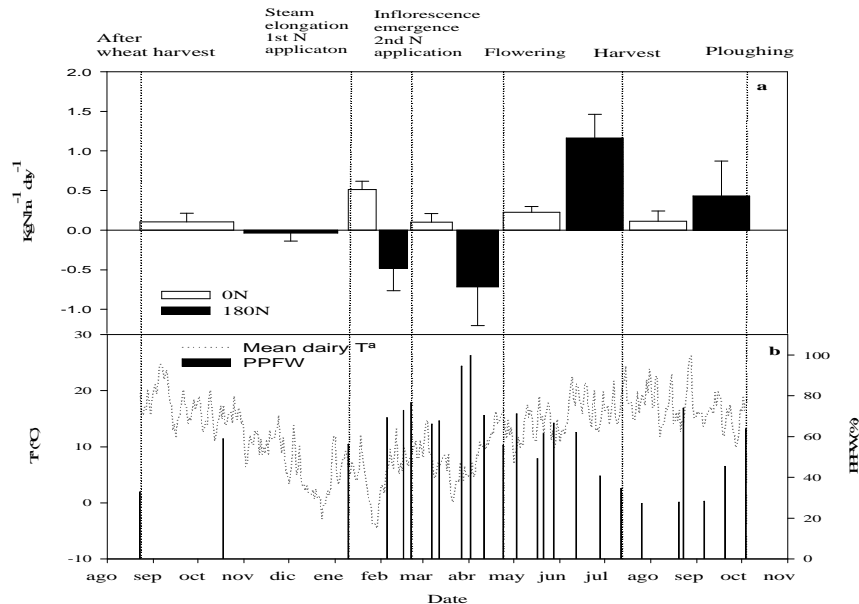

Figure 1. Nitrogen balance dynamics (kg N ha⁻¹) for the treatments 0N and 180N during 2006-2007 (a), and percentage of pores filled with water (PPFW) in each period and mean daily temperature (b).

4. Conclusion

Mineralization and immobilization patterns depend on environmental factors and also on the addition of mineral N fertilizer. Nitrogen immobilization was recorded after both N applications, but under favourable environmental conditions (field capacity and temperature above 15 °C) N mineralization was also higher when N was applied.

Acknowledgements

This work has been financially supported by the Spanish government (Project n° RTA2009-00028-C03-01) and the Department of the Environment, Regional Planning, Agriculture and Fisheries of the Basque Government. Besides, this work was supported by a grant from the Department of Education, Universities and Research of the Basque Government.

References

- Hocking, P.J., Randall, P.J. and DeMarco, D. 1997. The response of dryland canola to nitrogen fertilizer: partitioning and mobilization of dry matter and nitrogen, and nitrogen effects on yield component. *Field Crops Research* 54, 201-220
- Justes, E., Mary, B. and Nicolardot, B. 1999. Comparing the effectiveness of radish cover crop, oilseed rape volunteers and oilseed rape residues incorporation for reducing nitrate leaching. *Nutrient Cycling in Agroecosystems* 55 (3), 207-220
- Malagoli, P., Lainé, P., Rossato, L. and Ourry, A. 2005. Dynamics of nitrogen uptake and mobilization in field-grown winter oilseed rape (*Brassica napus*) from stem extension to harvest. I. Global N flows between vegetative and reproductive tissues in relation to leaf fall and their residual N. *Annals of Botany* 95, 853-861
- Nielsen, N.E. and Jensen, H.E. 1986. The course of nitrogen uptake by spring barley from soil and fertilizer nitrogen. *Plant and Soil* 91, 391-395
- Sierra, J. 1997. Temperature and soil moisture dependence of N mineralization in intact soil cores. *Soil Biology and Biochemistry* 29 (9/10), 1557-1563

The effect of measures implemented from 2003 to 2007 to reduce Nitrogen leaching from agricultural land in Denmark

Børgesen, C. D., Vinther, F. P

Department of Agroecology, Aarhus University

P. O. Box 50, DK-8830 Tjele, Denmark

1. Background & Objectives

The Danish Action Plan for the Aquatic Environment III (APAE III) from 2004 is a follow-up on earlier action plans with the first from 1987. The target of APAE I (1987) was to reduce the leaching of nitrate from the root zone with 50%, equal to 100.000 ton N (mean reduction of 36 kg N ha⁻¹) within five years. The goal has been revised several times since then and with the APAE III agreement covering the period 2004-2015 the N reduction target to be achieved by 2015 - is a 13% reduction in nitrogen leaching compared to the 2003 level (total reduction 21.150 tons N , mean reduction of 8 kg N ha⁻¹). A number of measures have been implemented through regulations up until 2007. These measures together with changes in cropping systems and N fertilization has been evaluated in the midterm evaluation of APAE III in 2008 and published in Børgesen et al., (2009).

The aim of this paper is to present the simulated N leaching results for Denmark for the period 2003-2007 and to obtain the different effects of the measures and other crop and N-fertilization changes on the N leaching. The analysis can be used to point out the uncertainty of the planned effectiveness of measures and as an example on how farmers in Denmark have adopted to the measure catch crop.

2. Materials & Methods

Based on model analysis using two N leaching models the *GNL N leaching model* (based on Basic Daisy (Abrahamsen et al., 2001) model simulations and the empirical *NLES4 leaching models* Kristensen et al. (2008)) the leaching where calculated for all agricultural fields in Denmark (app. 2.7 mill. ha) for each of the year's 2003, 2007. The input data to the leaching models are annual farm specific crop rotation and N fertilization schemes setup from annual farm data on crops and used N-fertilizers extracted from national farm databases. The simulation were conducted on field scale using soil data extracted from national soil databases, crop rotation and fertilization scheme obtained on farm scale and weather data for the period 1990-2005 obtained from regional meteorological stations. The mean annual field results are aggregated to farm, regional and national scale. The measures implemented to reduce N leaching with APAE III were: increase area with catch crops, afforestation, increase utilization of special type of animal manure, constructed wetlands, reduction in the agricultural area, reduction in farm production intensity, increased area with reduced N fertilization. The effect of constructed wetlands was only evaluated by the reduction in farm land. The other measures affected the actual farm register data on agricultural land, cropping and N fertilization and in this way is included in analysis.

3. Results & Discussion

The different measures has gradually been implemented over the period along with changes in cropping systems, farm structural changes (increase in number of dairy cows, a small reduction in number of pigs), N fertilization, which affects the N leaching. In Table 1 is shown the annual total N use (N input) and the N leaching calculated with the two models. The total N input is quite stable throughout the period, although there are changes in total N input due to reduction in N fixation, year to year variation in mineral and organic N fertilizer. The simulated nitrogen leaching decreased over the period for both models. As the simulated results are based on a number of assumptions,

generalizations and data uncertainties, there is a high uncertainty on the results. The analysis showed that the effect of the implemented measures was generally lower than the effect of other factors. Especially the change in cropping systems over the period has been found to have a high effect on leaching. The land use changes in the period showed an increase in winter cereals, grass in rotation and maize for silage, and a decrease in the area with spring barley and peas. The total use of nitrogen for Denmark is regulated so it can't exceed the maximum of 10% below the actual demand in 2003. In reality the N fertilization level is by 2007 reduced to app. 14% below the optimal N rate. This is caused by change in cropping systems (more winter crops with higher N rates) which has increased the total N demand. The catch crop area was planned with APAE III to increase with 40.000 ha during the period but the area only increased with app 13.000 ha. The primary reason was that the rules for growing catch crops after cereals was changed in 2005, so that the farmers could avoid catch crops by instead having 100% winter grown crops. The general rule for catch crops in Denmark (2007) was that each farmer should have 6% or 10% of the cultivated land grown with catch crops depending on live stock density (LSU). <0.8 LSU/ha = 6%, >0.8LSU/ha =10%. In 2012 this demand has been increased to 10% and 14% respectively. The changes in rules in 2005 was especially adopted by the plant- and pig farmers which together with other factors resulted in increase in winter grown cereals and winter rape and a reduction in spring grown crops. All together the changes in cropping systems have been found to reduce the simulated N leaching more than the different implemented measures.

Table 1. Annual Nitrogen input and simulated N leaching for the agricultural area in Denmark

Year	Min. N fertilizer	Org. N fertilizer	N fixation	N- deposition	Total N input	GNL/ DAISY	N- Les4	Mean
	-----N input -----					-----N leaching -----		
2003	195	238	28	47	508	172	163	168
2004	199	238	27	47	511	175	163	162
2005	201	232	24	48	505	164	161	159
2006	187	224	24	47	482	149	161	156
2007	195	241	23	47	506	159	154	157

4. Conclusion

The effect of land use changes on N leaching was found higher than the effects of the measures implemented with APAE III. The two models showed the same level and the same trend in the simulated N leaching on national level – but not on regional scale. The reduction was not found to be clear due to uncertainty in models and farm data. Many farmers adapted to alternative regulation (100% green fields) to avoid catch crops.

References.

- Abrahamsen, P. and Hansen, S. 2000. Daisy: an open soil-crop-atmosphere system model. *Environmental Modelling and Software* 15, 313-330.
- Børgesen, C.D., Waagepetersen, J., Iversen, T.M., Grant, R., Jacobsen, B. and Elmholt S. 2009 Midtvejsevaluering af vandmiljøplan III : Hoved- og baggrundsnotate. (DJF Plant Science 142).
- Reestimation and further development in the model N-LES - N-LES₃ to N-LES₄. 2008. Kristensen K, Waagepetersen J, Børgesen C.D, Vinther F. P, Grant R, Blicher-Mathiesen G. Aarhus University, Det Jordbrugsvidenskabelige Fakultet, 2008. 25 s. (DJF Plant Science; 139).

The Environmental Virtual Observatory (EVO): can cloud-based modelling provide new understanding of nutrient cycling processes from catchment to national scale?

Greene, S.^a, Johnes, P.J.^a, Freer, J.^b, O'Doni, N.^b, Bloomfield, J.P.^c, Reaney, S.M.^d, MacLeod, C.J.A.^e

^a School of Human and Environmental Sciences, University of Reading, Reading, RG6 6DW, UK

^b School of Geographical Sciences, University of Bristol, University Road, Bristol, BS8 1SS, UK

^c British Geological Survey, Maclean Building, Crowmarsh Gifford, Wallingford Oxfordshire, OX10 8BB, UK

^d Department of Geography, Durham University, Durham, DH1 3LE, UK

^e The James Hutton Institute, Craigiebuckler, Aberdeen, AB15 8QH, UK

1. Background & Objectives

Increasing anthropogenic demands on the environment, coupled with legislative pressures exerted by environmental policies, provide a major challenge for the management of water resources, especially in the context of nutrient enrichment (Sims et al., 2005; Vitousek et al., 2009). Observations of the inadequacy of existing tools and approaches to address these challenges provided the motivation for the Environmental Virtual Observatory pilot (EVOp), an innovation from the UK Natural Environment Research Council (NERC). The EVOp is currently exploring the use of a cloud-based infrastructure in catchment science by developing an exemplar to explore N and P fluxes to inland and coastal waters in the UK from catchment to national scale. The objective for this exemplar is to demonstrate the ways in which ensemble modelling of the major nutrient cycles, together with scenario analysis and prediction within an uncertainty framework at various scales, supported by a cloud environment, may be used to address a range of research questions pertinent to environmental policy in the UK.

2. Materials & Methods

The export coefficient model (Johnes, 1996), adapted to function on a geoclimatic basis (e.g. Johnes and Butterfield, 2002), and using a range of high resolution, geo-referenced digital datasets within a cloud environment comprises initial demonstration of the capabilities of N and P flux modelling in the EVOp. Geoclimatic regions, landscape units displaying homogenous or quasi-homogenous functional behaviour in terms of process controls on N and P cycling, are key to this approach; ten regions have been defined across the UK using GIS manipulation of spatial data describing hydrogeology, runoff, topographical slope and soil parent material. The export coefficient model operates within a regional framework, providing mapped, tabulated and statistical outputs at various UK Government reporting scales: river catchment, WFD RBD, coastal drainage and OSPAR zone. Model estimations are assessed against national monitoring data for the UK.

3. Results & Discussion

Model outputs demonstrate significant patterns in N and P flux to waters at differing scales and generated a range of summary statistics. Moreover, model uncertainty varies across space. These results can be used to further explore the primary drivers for spatial variation and identify waterbodies at risk, especially in unmonitored catchments. The technical and computational support of a cloud-based infrastructure also facilitates scenario analysis exploring potential water quality impacts of future mitigation strategies. Current research involves derivation of a regional framework to support a fully coupled N/P and hydrological modelling.

4. Conclusion

The use of cloud-based modelling to integrate national datasets and mathematical models has provided new information on variations in N and P fluxes across the UK at various scales. Furthermore, improved access to data and models for use by catchment managers and policy makers prioritises the advancement of effective catchment science.

References

- Johnes, P.J. 1996. Evaluation and management of the impact of land use change on the nitrogen and phosphorus load delivered to surface waters: the export coefficient modelling approach. *Journal of Hydrology* 183(3-4): 323-349.
- Johnes, P.J. and Butterfield, D. 2002. Landscape regional and global estimates of nitrogen flux from land to ocean: errors and uncertainties. *Biogeochemistry* 57/58, 429-47
- Sims, J.T., Bergström, L., Bowman, B.T. and Oenema, O. 2005. Nutrient management for intensive animal agriculture: Policies and practices for sustainability, *Soil Use and Management* 21(Suppl.): 141-151.
- Vitousek P.M., Naylor R., Crews T., David, M.B., Drinkwater L.E., Holland, E., Johnes, P.J., Katzenberger, J., Martinelli, L. A., Matson, P.A., Nziguheba, G., Ojima, D., Palm, C. A., Robertson, G.P., Sanchez, P. A., Townsend, A.R. and Zhang, F.S. 2009. Nutrient imbalances in agricultural development. *Science* 324, 1519-1520

The use of Integrated Constructed Wetlands (ICW) in the management of nitrogen (N) enriched effluents.

Harrington, R.^a, Carroll, P.^a, McInnes, R.^b, Everard, M.^c, Harrington, C.^{d, e}

^a Waterford County Council, Adamstown, Waterford, Ireland

^b RM Wetlands & Environment Ltd, 6 Ladman Villas, Littleworth, Faringdon, Oxfordshire, SN7 8EQ, UK

^c M.Everard, Evidence Directorate, Environment Agency, Horizon House, Deanery Road, Bristol BS1 5AH

^d Institute for Infrastructure and Environment, School of Engineering, The University of Edinburgh, William Rankine Building, The King's Buildings, Edinburgh EH9 3JL, Scotland, United Kingdom

^e Teagasc, Johnstown Castle Research Centre, County Wexford, Ireland

Abstract

Air, water and soil are inextricably linked through biogeochemical processes evolved over 3.8 billion years (Paul, 2007). The interfaces whereby these processes occur are various and there is increasing evidence to suggest that wetland ecosystems, especially those that support dense helophytic vegetation are particularly capable of supporting these processing capacities (van der Valk, 2007). Over the past 15 years and building on earlier efforts in riparian restoration ecology, the capacity of shallow helophytic wetlands has become better understood and applied to a range of nutrient enriched effluent streams including amongst others, that of farmyard and municipal wastewater (Harrington and McInnes, 2009; Harrington and Scholz, 2010). Originating from its basis in restoration ecology, the approach taken has been one that has focused on overall ecosystem function and consequently incorporated an understanding of the need to explicitly integrate water management with that of biodiversity and landscape-fit/aesthetic needs and is now known as the Integrated Constructed Wetland (ICW) concept (Harrington and Ryder, 2002; Harrington and Scholz, 2007). The capacity of these systems to manage water vectored nitrogen (N) in a manner that is socially, economically and environmentally coherent is presented. Emphasis is placed upon distinguishing between the accumulating recyclable organic-bound N in the detritus and necromass, and that in solution, which is denitrified at each stage from the through-flowing water in multi-cell ICW systems. Emphasis is placed upon understanding and mitigating any potential untoward environmental impacts while simultaneously facilitating efficient agricultural practice. The capacities of ICW-type wetlands to manage various types of water-vectored animal wastes are also presented. Furthermore, the wider benefits derived from the placement of ICW infrastructure in the rural landscape are presented, particularly those that might be brought into the mainstream of water, land and biodiversity management and that are especially relevant to the management of N.

References

- Harrington, C. and Scholz, M. 2010. Assessment of pre-digested piggery wastewater treatment operations with surface flow integrated constructed wetland systems. *Bioresource Technology* 101(20), 7713-7723.
- Harrington, R. and McInnes, R. 2009. Integrated Constructed Wetlands (ICW) for livestock wastewater management. *Bioresource Technology* 100(22), 5498-5505.
- Paul E.A. 2007. *Soil microbiology and biochemistry* (3rd edition), Oxford, United Kingdom.
- Van der Valk, A.G. 2006. *The Biology of Freshwater Wetlands*. Oxford University Press, Oxford.
- Harrington, R. and Ryder, C. 2002. The use of integrated constructed wetlands in the management of farmyard runoff and waste water. In "Proceedings of the National Hydrology Seminar on Water Resource Management: Sustainable Supply and Demand", The Irish National Committees of the International Hydrological Programme and International Commission on Irrigation and Drainage, Tullamore, Offaly, pages 55-63.

Tools to improve N cycle models

Betteridge, K., Li, F.Y., Costall, D.C.

AgResearch Grasslands, Private Bag 11008, Palmerston North, New Zealand

1. Background & Objectives

Return of urinary nitrogen (N) to grazed pastures predominates over faecal N return by a factor of about 2. While recent N models recognise that urinary N return is heterogeneous, few if any acknowledge the temporal variability in urinary N concentration (U_N) and urine volume (U_V) from individual cows or variability amongst cows grazing the same pasture. We hypothesise that urination events with large volumes or high urinary N concentrations will have a disproportionately high risk of N leaching due to the non-linear relationship between N load and N leaching. The purpose of our research is to develop a framework that handles spatio-temporal variability in urinary output by grazing cattle to predict potential errors of modelling without this variability. We also report on a new urine sensor for grazing cows that estimates urine volume and urinary N concentration of each urination event. With a GPS, the location of these urine patches can be used to determine the consequence of strongly skewed urine return by cattle to campsites, especially in hill pastures, on N leaching and nitrous oxide emissions. This work will assist us to develop efficient targeted N loss mitigation strategies.

2. Methods and Materials

We developed a framework to estimate N leaching where effects of variations in U_V and U_N on N load in urine patches as well as the proportion of the paddock area affected by urine can be estimated. Two contrasting pumice soils from the Lake Taupo catchment, New Zealand, were used for this study and ryegrass/white clover pastures were rotationally grazed 9 times/yr to a residual stubble of 1250 kg DM/ha. Weather data (1975-2005) from the north Taupo region (-38.525S, 175.825E) were obtained from interpolated virtual climate station data. Mean annual rainfall is 1484 mm and mean temperature 11.6°C. Urine data used in this study were taken from Betteridge et al., (1986) who measured U_N and estimated U_V of each urination event of two steers over three 24 h periods. Urination frequency ranged between 13 and 73 events/day, U_V from 7.6 to 51.2 L/day and U_N ranged between 0.8 to 14.1 mg N/L. These data were used to develop probability density curves that are described by lognormal functions for both U_N and U_V . We modelled situations where U_V and U_N varied; and where U_V or U_N alone was varied with the other parameter held constant. For comparison, estimated N leaching from a base-line scenario using an average U_N of 7.5 g N/L and average U_V of 2.5 L was also determined. APSIM 7.3 (Keating et al., 2003) was used to estimate N leaching. This involves *AgPasture* to simulate pasture growth and N uptake, *SurfaceOM* to simulate residue decomposition at the soil surface, *SoilN2* to simulate soil carbon-nitrogen dynamics, and *SWIM2*. All modules, with the exception of *SWIM2*, perform the calculations on a daily time-step, so as to simulate the fast infiltration of urine after deposition. We also developed a module to add urine within the soil profile to a given depth in a wetted soil volume shaped as an inverted cone. Using this framework and N leaching curves in response to N load, we estimate the N leaching losses at the patch level and then up-scaled the estimates to the paddock level. Effects of variations in the N load and urine patch area on N leaching are evaluated by comparing the estimates using variable urine patches with the base-line scenario. In all simulations the amount of urine-N returned each year was held constant with grazing intensity varied ensure this. Sensitivities of N leaching to varying U_V or U_N were assessed by varying either U_V or its U_N separately in the analysis.

Novel urine sensor This sensor fits to the rear of a cow to estimate U_N and U_V of each urination event. U_V is estimated by integrating pressure head over time within a slotted chamber through which urine passes to the ground. Refractive index of the urine, that we calibrate against urea-N and glycine in artificial urine, is determined at the base of this chamber. A ZigBee radio transmitter system and four ZigBee nodes around the perimeter of the paddock determines the position of each urination event within the paddock. Real time transmission of urine and position data to a base computer is possible.

3. Results & Discussion

We found that for the same amount of urinary N deposited and the same number of urination events per year, N leaching losses at paddock scale were 7.6% and 4.7% higher where U_V and U_N varied as opposed to where average U_V and U_N values were used, for the two pumice soils. This finding probably reflects the substantially higher N loss as U_N increases, as occurs with early morning urination events, compared to a low loss from dilute urine that is often passed in the afternoon (Betteridge et al., 1986). At the paddock scale, N leaching increased logarithmically with increased average U_V or U_N , whereas at the patch level N leaching increased exponentially with N deposition rate. Where average U_V was held constant but U_N varied, estimated N leaching was higher than where U_N was constant while U_V varied. Leaching loss was highly sensitive to U_V when U_N was constant such that by halving volume from 2.5 L to 1.25 L/event leaching was reduced by an average 16% in the two soils. Halving U_N while U_V was held constant resulted in an even larger leaching reduction of 25% across these soils. Thus salt, given cattle as a diuretic, will increase urination frequency and possibly lower U_V , and will reduce U_N to substantially reduce N leaching.

Our findings support the need to have a better understanding of U_V and U_N of individual urination events to more accurately estimate N emissions to the environment. Our urine sensor is capable of measuring these parameters in grazing cows and will enable urine patches of known urine characteristics to be quickly located and used for N emission studies. The combination of the framework model and urine sensor will greatly assist in evaluating mitigation strategies that are expressed through changed urination characteristics. Initial data from one cow over 4 days shows a coefficient of variation for volume of 36% and for urinary nitrogen concentration of 28% amongst individual urination events.

4. Conclusion

The framework model demonstrated that estimated N leaching was more sensitive to changing U_N than to changing U_V at the patch level whereas at the paddock level, the effects of urine volume and N concentration were more similar. Mitigation strategies that result in urination events that are more frequent, of lower concentration or lower volume will reduce N losses to the environment. Salt fed as a diuretic is one such strategy that may provide these criteria.

References

- Betteridge, K., Andrewes, W.G.K. and Sedcole, J.R. 1986. Intake and excretion of nitrogen, potassium and phosphorus by grazing steers. *J. Agr. Sci.* 106, 393-404.
- Keating, B.A., Carberry, P.S., Hammer, G.L., Probert, M.E., Robertson, M.J., Holzworth, D., Huth, N.I., Hargreaves, J.N.G., Meinke, H., Hochman, Z., McLean, G., Verburg, K., Snow, V., Dimes, J.P., Silburn, M., Wang, E., Brown, S., Bristow, K.L., Asseng, S., Chapman, S., McCown, R.L., Freebairn, D.M. and Smith, C.J. 2003. An overview of APSIM, a model designed for farming systems simulation. *Eur. J. Agron.* 18, 267-288.

Use of a systems model to estimate the impact of management decisions on nitrate leaching under intensive cropping

Sharp, J.M.^a, Thomas, S.M.^a, Fraser, P.M.^a, Brown, H.E.^a

^a The New Zealand Institute of Plant and Food Research Limited, Private Bag 4704, Christchurch 8140, New Zealand

1. Background & Objectives

There is a growing need for agricultural systems models to address the implications of management decisions on nutrient cycling and losses. Tools to predict the effects of land management on groundwater quality are needed by both farmers and policy makers. While there are models that can estimate nutrient losses from single crops there are few that can give meaningful outputs for cropping rotations and simultaneously assess the impacts of complex management decisions. The Agricultural Production Systems sIMulator (APSIM) is a suite of modules that enable the simulation of systems covering a range of plant, animal, soil, climate and management interactions (Keating et al., 2003). In this paper we report a test of APSIM to simulate nitrate (NO₃) leaching with data from a field experiment, designed to measure the effects of irrigation and fertiliser on year-round nitrogen (N) losses. The model can then be used to determine its assessment of the most appropriate management for the system.

2. Materials & Methods

Data were collected from a field trial with a factorial combination of N fertiliser rates and irrigation managements in a randomised block design. The experiment was established at Lincoln, Canterbury, New Zealand in spring 2004 on a well-drained, intensively cropped soil. It included four replicates of two crop rotations: potatoes – winter fallow – spring peas – winter fallow – potatoes – triticale and potatoes – winter wheat – winter fallow – potatoes – triticale. Each main plot was split into two different irrigation rates (optimum (W1) and either increased frequency or increased amount (W2)), and these sub-plots were split again into three different N fertiliser rates (nil (N0), optimum (N1) and excess (N2)). Irrigation was applied using drip lines and N fertiliser as calcium ammonium nitrate. Soil mineral N, crop dry matter, crop N, soil water content and leachate N concentration were measured at regular intervals throughout the trial. Nitrogen leaching, calculated using the soil solution NO₃ concentration measured from samples collected in ceramic cups and the drainage calculated by APSIM through the use of a water balance model, was compared with simulations from APSIM 7.3. APSIM allowed the integration of crop models with an underlying soil module which simulates soil water movement and nutrient supply. The crop modules used were 'potato', 'wheat', 'triticale' and 'fieldpea'. The soil water module SoilWat was used. The soil description (e.g. soil texture, bulk density, soil carbon and N) and initial values were provided from soil profile data collected at the start of the experiment. Soil NO₃-N was reset to measured values at the beginning of each part of the rotation.

3. Results & Discussion

APSIM accurately simulated the amount of N taken up by the crops at harvest. The primary source of N loss from the system was NO₃ leaching, with predictions of annual leaching exceeding the observed. Estimates of leaching, both experimentally and in APSIM, are a product of drainage and the soil solution NO₃ concentration. While there were no direct measurements of drainage in the field experiment with which to test APSIM against, intensive measurements of soil water content were taken.

APSIM predicted soil water content well in all layers except in the top layer for potato crops. This discrepancy may be due to differences in the soil bulk density between the potato ridges and furrows not simulated by APSIM. Nevertheless, through all of the soil layers, APSIM simulations track the observed data through time, and responded to changing soil water content with the wetting and drying of soil. Given that measured irrigation and rainfall data was used by APSIM for the water inputs to the system and that the soil water content is well approximated by APSIM simulations, drainage from the system appears to be simulated appropriately. This therefore suggests that the overestimation of annual leaching in the APSIM simulations may be due to an overestimation of soil solution NO_3 concentration passing down through the layers of the soil profile, or that some leaching events were not adequately captured by the field monitoring.

Within APSIM's SoilWat module the saturated and unsaturated flows of soil water are used to calculate the redistribution of solutes using a 'mixing' algorithm (APSIM Undated). Essentially solute movement is calculated as the product of the water flow and the solute concentration in that water. The solute concentration leaving a layer is calculated from the solute concentration entering that layer, modified by mixing between water draining through the layer and the water already in the layer. In APSIM 7.3 it is assumed that both saturated and unsaturated flow have mixing efficiency factors of 1.0, which assumes drainage water is fully mixed with the water present in the layer. If this assumption is relaxed, so that when there is saturated flow there is not complete mixing, as might occur during preferential flow, less solution NO_3 will be moved down through and out of the soil profile. For this modelling study an efficiency factor of 0.7 gave the best fit of predicted annual NO_3 leaching values to those observed in the experiment.

The modified model was then used to determine an appropriate management strategy for the rotations in question which balanced achieving high yields and minimising NO_3 leaching losses. APSIM and other similar agricultural system models that can reliably simulate the effects of management on nutrient losses over crop rotations have great potential for helping land users and policy makers make management and land use decisions that avoid adverse environmental impacts.

4. Conclusion

The importance of datasets such as this, with multiple crops within rotations, and intensive N and water measurements, to parameterise and test systems models is highlighted. APSIM successfully simulated the N and water balance of this crop rotation. However, analysis showed that APSIM over-estimates the leaching of mineral N through the soil profile, and when adjustments are made, estimates of leaching are much improved. There is also a need for better understanding of the controls of solute mixing within the soil profile, and modifications are required to account for ridges and hollows seen in potato crops. The system model was then applied to determine a management strategy of this system that balanced the priorities of increasing yield and minimising NO_3 leaching.

References

APSIM (Undated). SoilWat Documentation. <http://www.apsim.info/Wiki/SoilWat.ashx>. APSIM Initiative.
Keating, B.A, Carberry, P.S, Hammer, G.L, Probert, M.E, Robertson, M.J, Holzworth, D, Huth, N.I, Hargreaves, J.N.G, Meinke, H, Hochman, Z, McLean, G, Verburg, K, Snow, V, Dimes, JP, Silburn, M, Wang, E, Brown, S, Bristow, K.L, Asseng, S, Chapman, S, McCown, R.L, Freebairn, D.M and Smith, C.J. 2003. An overview of APSIM, a model designed for farming systems simulation. *European Journal of Agronomy* 18, 267-288.

Use of chemical amendment of dairy cattle slurry to reduce phosphorus losses from dairy cattle slurry while allowing land spreading of slurry to meet nitrogen requirements.

Brennan, R.B.^a, Healy, M.G.^a, Lanigan, G.^b, Fenton, O.^b

^aCivil Engineering, National University of Ireland, Co. Galway, Rep. of Ireland.

^bTeagasc, Johnstown Castle, Environmental Research Centre, Co Wexford, Rep. of Ireland.

1. Background & Objectives

Under the European Union Water Framework Directive (EU WFD), River Basin District (RBD) managers must implement Programmes of Measures (POM) by 2012 within a catchment where an individual waterbody has been classified as below good status or are at risk of not reaching at least “good ecological status” by 2015. It is widely documented that many waterbodies in Europe will not achieve the desired water quality status by 2015 due to catchment buffering and long transit times (Cherry et al., 2008). Chemical amendment of dairy cattle slurry has been proposed as a mitigation measure to reduce incidental phosphorus (P) losses from agriculture (Brennan et al., 2011a). Brennan et al. (2011b) showed that amendments were effective at reducing incidental P losses with no adverse effect on suspended sediment (SS) or metal release. In subsequent work, Brennan et al. (unpublished) examined pollution swapping potential due to effects of amendments on greenhouse gas (GHG) losses and on nitrogen (N) in runoff. The aim of the present study was to discuss the feasibility of chemical amendment of dairy cattle slurry in Ireland.

2. Materials & Methods

A controlled agitator experiment was designed to identify the most effective chemical amendment to reduce dissolved reactive phosphorus (DRP) release to water overlying grassed soil cores, which received un-amended and amended dairy cattle slurry. In addition to effectiveness, the feasibility of these amendments was determined based on several criteria: estimated cost of amendment, amendment delivery to farm, addition of amendment to slurry, and slurry spreading costs due to any volume increases. The best amendments were then added to slurry immediately before it was surface applied to grassed-soil in laboratory runoff boxes, which were subjected to simulated rainfall events. Analysis of overland flow showed that PAC (poly-aluminium chloride, the most commercially available form of AlCl_3) was the most effective amendment for decreasing DRP losses in runoff following slurry application, while alum proved to be the most effective for total P (TP) and particulate P (PP) reduction. The incidental loss of metals (aluminium (Al), calcium (Ca) and iron (Fe)) in runoff during all experiments was below the maximum allowable concentrations (MAC) for receiving waters. Following this, the ‘pollution swapping’ potential of the amendments was examined. A laboratory-scale gas chamber experiment was conducted to examine emissions of ammonia (NH_3), nitrous oxide (N_2O), methane (CH_4) and carbon dioxide (CO_2).

3. Results & Discussion

Following beaker experiments the four best amendments were selected for further study based on effectiveness and feasibility. At optimum application rates the amendments selected were: ferric chloride (FeCl_2), which reduced the DRP in overlying water by 88%, aluminium chloride (AlCl_3) (87%), alum (83%) and lime (81%). The runoff-box results verified these findings and following while the gas chamber experiments allowed pollution swapping to be considered as part of the decision making criterion. The amendments recommended for a field study were, from best to worst: PAC, alum and lime. This component of the study investigated how soil and chemically amended slurry interactions affects amendment effectiveness under field conditions. The results of

this field study validated the results from the laboratory-scale studies. Alum and PAC reduced average flow-weighted mean concentration (FWMC) and total loads of DRP, dissolved un-reactive phosphorus (DUP), PP and TP in runoff, while amendment of slurry with lime at the rate examined in this study was not effective at reducing P losses. Alum amendment significantly increased average FWMC of ammonium-N ($\text{NH}_4\text{-N}$) in runoff water during the first rainfall event after the slurry was applied (an 84% increase). This study compiled these results to give a feasibility analysis for chemical amendments in Ireland.

Table 1 Summary of feasibility of amendments. Marks for feasibility (agitator test), pollution swapping (greenhouse gas experiment) and plot study are from 1 to 5. 1 = best; 4 = worst.

Chemical	Agitator score P	GHG	Field	Combined feasibility score	Notes
Alum	1	4	1	6	Risk of effervescence Risk of release of H_2S due to anaerobic conditions and reduced pH Cheap and used widely in water treatment Reduced ammonia emissions
AlCl_3 (PAC)	2	1	2	5	No risk of effervescence (Smith et al., 2004) AlCl_3 increased handling difficulty Expensive Reduced ammonia emissions
FeCl_2 (FeCl_3)	3	3	4	10	Potential for Fe bonds to break down in anaerobic conditions Increased release of N_2O Reduced ammonia emissions Not examined in plot study
Ca(OH)_2	4	2	3	11	Increased NH_3 loss Strong odour Hazardous substance Not effective in plot study

4. Conclusion

Chemical amendments are very effective at reducing P loss from dairy cattle slurry and have been found to have no significant adverse effects or global warming potential and N loss to ground water. Chemical amendment of dairy cattle slurry is not currently feasible however it is possible that it may form part of a strategic P management programme in future. The next step is to examine the use of chemical amendment of dairy cattle slurry at farm and catchment scale.

References

- Brennan R.B., Fenton O., Rodgers M. and Healy M.G. 2011a. Evaluation of chemical amendments to control phosphorus losses from dairy slurry. *Soil Use and Management* 27, 238-246.
- Brennan, R.B., Fenton, O., Grant, J. and Healy, M.G. 2011b. Impact of chemical amendment of dairy cattle slurry on phosphorus, suspended sediment and metal loss to runoff from a grassland soil. *Science of the Total Environment* 409, 5111-5118.
- Cherry K.A., Shepard M., Withers P.J.A. and Mooney S.J. 2008. Assessing the effectiveness of actions to mitigate nutrient loss from agriculture: A review of methods. *Science of the Total Environment* 406, 1-23.

Using the Eurotate_N crop model to optimize nitrogen fertilization in potato crop

Olasolo, L., Vázquez, N., Suso, M.L, Pardo, A

SIDTA, Government of La Rioja. Ctra. Mendavia-Logroño NA-134, km.90. 26071. Logroño, Spain

1. Background & Objectives

Eurotate_N is a decision support system for soil-plant interactions based on the use of nitrogen in crop rotations and can be used to compare the effects of different fertilizer rates and other management practices, within a wide range of production systems and climatic conditions across Europe (EU-Rotate, 2002). Due to the high nitrate concentration in groundwater, the alluvial plain of The Oja River (North Spain) has been designated a Nitrate Vulnerable Zone (NVZ). In this area, the prevalent crops are cereals, potatoes, peas and green beans. The performance of Eurotate for potatoes and green beans has been evaluated in previous studies (Olasolo, 2011; Olasolo, 2009). The aim of this study was to use the Eurotate_N crop simulation model in order to reduce application rates of nitrogen to commercial potato fields located in the Oja's NVZ.

2. Materials & Methods

Two experiments were carried out throughout 2010 in farm fields, sited in the NVZ. Each experiment had three treatments with different nitrogen fertilization management: Traditional Farming Practice (TFP), fertilization following the codes of Good Agricultural Practices (GAP) and optimal fertilization using the Eurotate_N model (EU). Experimental design was completely randomized with four replicates per treatment. In the EU Treatment optimal fertilization was defined before fertilizer was applied by carrying out a series of simulations with increasing doses of N and entering the updated data from the crop onto the model. In each simulation we determined the minimal dose of N applied that, without causing significant deficit of N in the crop, showed a suitable commercial production for our crop conditions. To assess the N deficit, N in plant and critical N simulated by the model were obtained and the nitrogen nutrition index (NNI) based on the critical N (minimum N concentration required for maximum growth) was used ($NNI = N\%_{\text{actual}}/N\%_{\text{critical}}$) (Gastal and Lemaire, 2002). Soil moisture content, soil mineral nitrogen, dry matter and nitrogen in the crop were measured throughout the crop season on a monthly basis in order to test and perform the simulations with the model. Weather data required by the model was obtained from a weather station located near the two farm fields. For each treatment in both experiments, residual nitrogen in soil, crop total-N uptake, accumulated dry matter and marketable yield were compared by analysis of variance with Systat[®] 12.0 (Systat software). The values of simulation carried out with the N dose selected as optimal (N dose applied in the EU treatment) were compared with the observed data in the EU treatment by the Student's t test.

3. Results & Discussion

Nitrogen applied to the EU treatment was 74 and 89 kg ha⁻¹ lower than TFP treatment in experiments 1 and 2, respectively (Table 1). At the time of harvest there were no significant differences between treatments in marketable yield, total biomass production and total N extracted by the plant. The residual N in the soil up to 60 cm depth was low in the two experiments for all treatments, 38 ± 2.4 and 35 ± 2.9 kg N ha⁻¹ on average in experiments 1 and 2, respectively (Table 1). In addition, Table 1 shows the most relevant values of the simulation carried out on both experiments with optimal dose (EU treatment) on the Eurotate_N model. No significant differences were found, between the simulated values and those measured in the field, for marketable yield, biomass production and N extraction in any of the experiments. In contrast, the measured values of soil mineral N up to 60 cm were higher than those simulated by the model up to 90 cm.

Table 1. Total biomass production at harvest, marketable yield (MY), nitrogen fertilization (Fer-N), crop total-N uptake and N mineral up to 60 cm (measured data) and 90 cm (simulated data). Experiments 1&2 of 2010.

Experiment	treatment	Biomass		Fer-N	Total-N uptake	N mineral (kg N ha ⁻¹)	
		t ha ⁻¹	MY			NO ₃ ⁻	NH ₄ ⁺
1	TFP	14.4 ± 0.6	53.9 ± 1.5	74 + 110	175.9 ± 5.9	39.4 ± 11.2	3.1 ± 1.3
	GAP	14.6 ± 0.9	53.0 ± 2.8	30 + 120	154.7 ± 12.4	30.4 ± 2.9	2.1 ± 0.1
	EU	14.7 ± 0.9	52.8 ± 2.1	30 + 50 + 30	161.7 ± 13.8	35.3 ± 1.9	2.8 ± 0.7
	Signif ¹ .	n.s.	n.s.	.	n.s.	n.s.	n.s.
	TFP	12.9 ± 1.0	52.1 ± 3.7	104 + 105	147.5 ± 16.2	32.4 ± 6.6	5.2 ± 0.6
2	GAP	12.7 ± 0.7	49.3 ± 4.3	30 + 120	154.8 ± 12.7	32.7 ± 4.9	5.3 ± 0.5
	EU	13.7 ± 1.1	54.9 ± 3.9	30 + 50 + 40	169.0 ± 7.9	26.5 ± 3.9	4.1 ± 0.6
	Signif ¹ .	n.s.	n.s.	.	n.s.	n.s.	n.s.
	Simulated data						
1	EU	15.6	60.5	30 + 50 + 30	178	10.9	
2	EU	14.1	55.3	30 + 50 + 40	157	7.1	

¹Statistical significance level $p \leq 0.05$; n.s. = non significant

From the results, it can be suggested that the difference of N fertilizer applied for the TFP and GAP treatments compared to the EU could be lost by leaching, mainly through irrigation water, as observed in previous studies in the area (Olasolo, 2007). These results suggest that the pre-sowing fertilization applied by the farmer could be reduced by 70% with consequent savings in fertilizer and decreased risk of N leaching. Similarly, the side-dress fertilization can be reduced by an adequate partition of nitrogen fertilizer application as in the EU treatment (Table 1). The model simulations were successful and allowed a reduction in the N applied to the crop, however further studies should be carried out in order to reduce the differences between observed and simulated data of soil mineral N.

4. Conclusions

Using the model a reduction of up to 43% of the applied N on the crop was possible. Furthermore, this reduction can be made without a decline in production compared to that obtained by the farmer. The usefulness of the Eurotate_N model in giving potato crop fertilization recommendations in the farm fields studied has been proven.

References

- EU-RotateN, 2002. Project number QLK5-2002-01110. <http://www2.warwick.ac.uk/fac/sci/whri/research/nitrogenandenvironment/eurotaten/>
- Gastal, F. and Lemaire G. 2002. N uptake and distribution in crops: an agronomical and ecophysiological perspective. *Journal of Experimental Botany* 53 (370), 789-799.
- Olasolo, L., Vázquez, N., Suso, ML. and Pardo, A. 2007. Estimación del drenaje y lavado de nitratos en un cultivo de patata en la zona vulnerable del aluvial del oja. *Actas de horticultura* 49, 249-252.
- Olasolo, L., Vázquez, N., Suso, ML. and Pardo, A. 2009. Preliminary evaluation of the crop model Eu-Rotate_N in a pea-green bean rotation. In *Proceedings of the 16th Nitrogen workshop. Connecting different scales of nitrogen use in agriculture: 547-548.*
- Olasolo, L., Vázquez, N., Suso, ML. and Pardo, A. 2011. Evaluación del modelo EU-Rotate_N en cultivo de patata. *Actas de Horticultura* (in press).

3 SESSION

Global Perspectives on Nitrogen and Food Security

Oral Presentations

The Challenge of Feeding 9-10 billion People Equitably and Sustainably

Godfray, H.C.J.

Oxford Martin Programme on the Future of Food, University of Oxford, Dept. Zoology, South Parks Rd., Oxford OX1 3PS

1. Introduction

Over the last forty years the price of food, at least as experienced by people living in high-income countries, has been in real-terms at historically low levels (Dorward, 2011). The major policy issue concerning food supply in developed countries has been how to support farmers who in a high-wage economy could not survive if exposed to the price of food on world markets. Investment in agricultural research has declined in the face of over-production, and the rate of increase in yields has slowed (Piesse and Thirtle, 2010). The widespread mid-century pessimism about the world's ability to feed itself was allayed by the great advances in productivity of the Green Revolution (Evenson and Gollin, 2003), and though large numbers of people still suffer from hunger, progress in reducing this number has until recently been good and it had looked as if the Millennium Development Goals on hunger were going to be met by 2015 (United Nations, 2009). Though many voices had raised concerns about the long-term viability of current modes of food production, sustainability has not been a central concern of food producers. Issues of balancing the demand and supply of food, and of keeping food prices within boundaries accepted by society, has not been the dominant political issue that it has been for most of human history.

The last five years has seen a sea-change in the attention paid to the security of food supply. The proximate reason for this was the sudden jump in food prices in 2007/2008 and their persistence and high volatility since then (Figure 1).

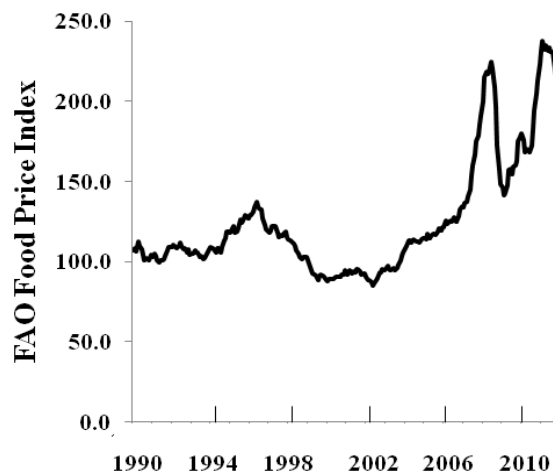

Figure 1. FAO food price index 1990 to February 2012.

The origins of the food price spikes are still strongly debated and are likely to be a mixture of long-term trends interacting with more short-term factors (Swinen and Squicciarini, 2012, Piesse and Thirtle, 2009, HMG, 2010). Of the former, the secular increase in food demand from a growing, richer population, especially in Southeast Asia, is particularly important. There has also been a long-term trend to reduce food stocks (in both the private and public sector) so that stock-to-use ratios were at historically low levels. By the end of the first decade of the current century the growth

in land area that had switched from food to biofuel production grew large enough to begin to impact on supply. Of the more short-term factors the flight of investment capital into commodities during the financial crisis, as well as poor harvests in Australia and elsewhere, were also likely to have had some effect.

2. What might happen to the food system in the next forty years

Further analysis is required to understand the factors influencing current supply but the major food price spikes led to the commissioning of a series of reports that explored what might happen to food supplies over a longer period of time, typically to mid-century (IAASTD, 2008; Foresight, 2011; Paillard et al., 2009; World Bank, 2008). Though their conclusions differ in detail, there is general agreement that the global food system is entering into a new phase where excess demand will replace excess supply as the dominant policy issue in the rich world, with great risks that recent progress in reducing hunger in the poor world will stall or reverse. Unless action is taken throughout the food system there is a real likelihood of food price rises that will give rise to political and economic dislocation. The reports also look at food production within an environmental context, not only the challenges of climate change but more generally the negative effects that current food production has on many aspects of the environment. Again there is general agreement that the way we produce food now undermines our ability to produce food in the future: we are eating into the natural capital upon which future food production will need to rely. For example, intensive agriculture that negatively effects soil structure reduces the capability of the land to produce food in the future.

The challenges to the food system are both on the demand and supply side (Godfray et al., 2010). As mentioned above demand will increase because there will be more mouths to feed as populations grow. Current estimates suggest that global populations will plateau somewhere between 9 and 10 billion in the second half of this century, but there is considerable uncertainty and recent estimates have tended to be revised upwards (Lutz and Samir, 2010). Average wealth will have increased which in many ways is a good thing (especially as richer societies tend to have lower fertility) but wealthier people demand a more varied diet and typically consume food types that require more resources to produce, for example many types of meat. The dramatic increase in meat consumption in China over the last few decades is already reshaping trade in agricultural commodities (Anderson, 2010). This rising demand will need to be met at the same time as a nexus of different factors threaten supply. Perhaps the most critical in the short term is water. Competition for freshwater will become ever fiercer from a growing population while more will need to be retained to allow the environmental flows that we now understand are essential to keep ecosystems functioning (Strzepek and Boehlert, 2010). Many highly productive irrigated areas currently rely on water pumped from underground aquifers that are being exploited at rates far in excess of the rates at which they are replenished. We shall see currently fertile areas of irrigated agriculture abandoned in the next few decades. To produce our food most types of agriculture require energy, both directly to power machinery, refrigeration etc., but indirectly in manufacturing agricultural inputs, in particular nitrogen fertiliser. No one can confidently predict energy prices into the future, but we shall most likely see an increase in energy costs, and probably much greater volatility (International Energy Agency, 2012). And overarching these supply side issues is the existential challenge of climate change (IPCC, 2007). It is currently very hard to predict exactly how climate change will impact future food production. Some regions will actually benefit from climate change and it is likely that the northern boundary of many crops will advance towards the pole. However, it is almost certain that the

negative consequences will outweigh (probably strongly outweigh), the positive. We shall see changes in temperature and rainfall patterns, and adapting to these conditions will be a major challenge for farmers. The frequency of extreme events will increase, and we shall see more storms, floods and droughts, and these are likely to affect larger spatial areas. In some places, most likely the arid tropics, agriculture or pastoralism may no longer be possible (Gornall et al., 2010).

What might these supply and demand pressures mean to prices? Given that food is at the present time relatively cheap and people in the future will be wealthier, a modest increase in prices that consumers can afford might actually stimulate more investment and innovation in food production. Predicting future food prices is hugely difficult and a craft rather than a science. It is largely done using economic models that assume equilibrium conditions – that prices quickly adjust to supply and demand in a world where all actors act rationally. They are essentially the only tools we have, though their projections must be treated with great caution. One of the best models available is called “IMPACT” and is operated by the International Food Policy Research Institute in Washington (Rosegrant et al., 2008). Not only does it have a core economic module, but it has further components that integrate expected climate change scenarios as well as competition for water in the world’s river basins. IMPACT can try to predict what happens to food prices in a world where current trends in the global food system continue and it is pretty much business as usual, or the same world but with climate change. The results are disturbing (Nelson et al., 2009, Nelson et al., 2010). In the absence of climate change the prices of most commodities rise by about 30-70% between 2000 and 2050. However, in the presence of climate change the price rises are much higher. For example, for staple grains price rises of well over 100% are projected.

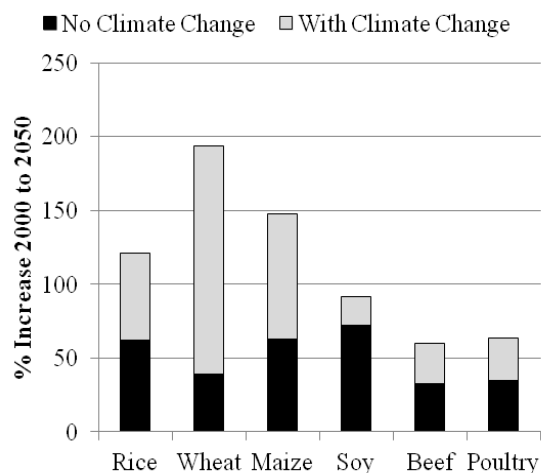

Figure 2. Projected increases in the price of selected food items between 2000 and 2050 with and without climate change. Source: Nelson et al. (2009).

It is important to reiterate that these projections should be treated with great caution, and that the precise numbers should not be given undue weight. But at the very least this and other studies that have come to similar conclusions, show that we need to pay more attention to food security. Food price rises of the magnitude described in Figure 2 would result in major political and economic disturbances. Even the relatively modest price increases of the last five years resulted in food riots in several African and south Asian states and in the fall of at least one government (Madagascar)

(Abbott and de Battisti, 2011). The ramifications of a doubling in food prices would be enormous.

3. General policy responses

What should be the policy response to these challenges? The next two paragraphs describe the recommendations in the UK Government's Foresight study *The Future of Food and Farming* (Foresight, 2011) which are in line with most recent analyses. First, the likelihood of there being major problems ahead is sufficiently high that action is needed throughout the food system. Certainly more food will need to be produced, but in addition diets will need to change, especially in the rich world. Second, the food system will need to be made more efficient, its governance improved and the amount of food waste reduced – perhaps 30% of all food produced is, for different reasons, never used. Third, sustainability must move centre stage in food policy. We shall need to be much more efficient in our use of inputs to reduce the negative environmental externalities of excessive water consumption and over-use of nitrogen. Food production will need to adapt to climate change and play its part in mitigation – by greater efficiency and by using agricultural land to lock up carbon. Finally, in an ever more globalised world the moral imperative to reduce hunger and poverty is increasingly aligned with the self-interests of the rich world who will not be able to escape the consequences of famine and food scarcity in least-developed countries.

In the past one of the main options to increase food supply was to increase the area under cultivation and even today there are considerable tracts of land that might be brought into agriculture. But this land is often forested, wetlands, or ancient grassland. Conversion to agriculture would liberate large quantities of greenhouse gases and would risk major exacerbation of climate change. Indeed, food security is intimately linked to climate change because if we fail on the former it will be much harder to address the latter. The world must thus operate on the assumption that to a good approximation there is no new land for agriculture (though restoration of degraded farmland will often be a priority). Therefore, more must be produced from the same area of land, and this must be done with less effect on the environment. This has been called sustainable intensification (Royal Society, 2009) and working out how it may be achieved is the greatest supply-side challenge in the coming decades. Much can be done using existing knowledge, especially if a pluralistic approach is taken, picking the best of all types of agricultural practice, from advanced conventional, through organic and agroecological approaches to learning from the experience and knowledge of indigenous peoples. But new research is also needed, not only to increase yield and productivity but also to maintain current yields in the face of new challenges from global change, from biological challenges such as weeds, pests and diseases that are continually evolving to exploit crops and livestock. It will also be important to address the particular needs of the world's poorest who have not benefitted from the scientific advances enjoyed by more wealthy food producers.

4. Nitrogen and food security

Nitrogen is one of the most important requirements for plant growth and the invention of the Haber-Bosch process in the early twentieth century that allowed for the relatively cheap manufacture of artificial fertilisers must rank as one of the most important scientific breakthroughs of all time (Smil, 2001). Cheap artificial fertilisers enabled the green revolution to occur and for hunger to be ended in many parts of the world (Evenson and Gollin, 2003). Nitrogen is also the single most important environmental pollutant produced by agriculture: nitrates entering the hydrological

cycle contaminate human drinking water and pollute rivers, lakes and the ocean, often leading to drastic reductions in biodiversity through eutrophication. Ammonia and other nitrogen compounds enter the atmosphere from farmland and are deposited on natural habitats, altering the ecological balance and in some areas rendering impossible the persistence of the highly diverse plant communities often associated with low nutrient soils (Vitousek et al., 1997). Agriculturally derived nitrous oxide (N_2O) is directly emitted from N fertiliser application, N deposited by domesticated animals, nitrogen fixation and mineralisation of N residues in soils. In addition, agriculture contributes significantly to the emission of carbon dioxide and methane (Stern, 2007). Nitrogen is both bane and boon to mankind.

What are the challenges to the research community involved in nitrogen as the world grapples with food security and the need for sustainable intensification? The first is straightforward and obvious – nitrogen needs to be used more efficiently. There are at least four different strands to increasing efficiency.

- There is much we can do with existing knowledge, especially if techniques from all types of agriculture are considered (Dawson and Hilton, 2011). Many agronomic techniques for different crops and cropping systems have been developed that get the fertiliser to the places where it is needed by the crop and at the right times, as well as retain nitrogen in the field and reduce losses (Day, 2011). These methods involve reduced application of artificial fertiliser and the more efficient use of manures and nitrogen fixing plants (including grass-clover lays and legume rotations etc.). The barriers to the wider take up of these methods are often insufficient skills and human capital, particular acute in areas where extension services are poorly developed (Foresight, 2011).
- Increasing nitrogen efficiency should be a major goal of agronomic research. At the more high-tech end of the research spectrum different forms of precision agriculture can greatly reduce the amount of fertiliser that needs to be applied, while plants can be bred (using conventional and GM techniques) to take up and utilise nitrogen more efficiently (Dunwell, 2011). Looking further into the future it may be possible to engineer nitrogen fixation into grains and other crops. High-tech research is attractive to the private sector as it generates IP but the importance of low-tech research to improve efficiency through better farming practices and soil management is equally as important and will likely require public funding (IAASTD, 2008)
- The behavioural economics of fertiliser application is complex and often not properly appreciated. Incorrect incentives can be set, such as in China where in some places extension workers were paid by kilogram of fertiliser offloaded on farmers, leading to dire pollution and in some cases crop stunting by nitrogen poisoning. Individual farmers will sometimes apply more fertiliser than economically rational because they are risk averse, or just because it is perceived as the right thing to do. Fertiliser manufacturers clearly have no interest in lessening this behaviour.
- Nitrogen application is a classic example of an action whose benefits are reaped by the actor but whose harm is experienced by other people, for example people drinking water from the same catchment, or the global population in the case of greenhouse gas emissions. These are negative externalities whose costs do not influence farmer behaviour. There are different ways that these negative externalities can be reduced. The major one in most developed countries is through regulation (for example the EU Nitrates Directive and Water Framework Directive). An alternative would be to “internalise the externalities” by for

example a nitrogen tax, though the effect this would have on food prices would need careful attention (Bateman et al., 2011).

Increasing efficiency without decreasing yields is an uncontroversial example of a “win-win” but by how much should yields be sacrificed to reduce negative externalities (typically in high-income countries) or increased pollution accepted as a price for increased yield (for example in low-income countries). There is no simple answer to this as the amount of food the world will need to produce in the coming decades depends on progress made on the demand side (restraining population growth, changing diets), and on efficiency (such as reducing waste) and better governance. But in thinking about these issues it is important to take several things into account.

First, the critical issue in comparing farming systems is not kg N fertiliser ha⁻¹ or pollutant loading ha⁻¹ but kg N fertiliser per kg food produced. There are indirect consequences of reducing yields that must be considered in assessing alternatives. The consequences for global greenhouse gas emissions of the Green Revolution and in particular the direct and indirect effects of increased nitrogen use (the latter including, for example, the energy used in fertiliser application and the Haber-Bosch process) are rightly highlighted as an issue demanding greater efficiency. Yet if the same amount of food was produced through extensification and in particular through land conversion, the greenhouse gas emissions would have been much worse (Burney et al., 2010). A study comparing land conversion and increased nitrogen application as alternative means of increasing substantially food supply by mid-century again came firmly down in favour of fertilisers (Tilman et al., 2011). Conversion of land can also have drastic effects on biodiversity and for some habitat types, tropical rainforests in particular, there is a growing evidence base that land “sparing” is a better strategy to conserve biodiversity than land “sharing” (Phalan et al., 2011). Such strategies will require both elevated yields on existing farmland, as well as a land use governance system that delivers “spared land” in the face of strong and conflicting contrary interests. Second, there is evidence that subsidising fertilisers in least developed countries may stimulate agriculture to move from subsistence to small business scales (Dorward and Chirwa, 2011). It may increase local food production, increase local incomes, and perhaps put money into sections of society that are hard to reach through other routes. But there are potential negative consequences that it will be important to try to minimise. Increased nitrogen application may lead to pollution, especially if subsidies are such that there are little incentives to be efficient. Input subsidies clearly distort markets and world trade negotiations are aimed at reducing them, though transitory special arrangements are allowed for poor nations. Nevertheless, as some countries are finding, removing subsidies can be politically very difficult, even when they are becoming a drain on national finances (Wiggins and Brooks, 2010). More economic and political science research on fertiliser subsidies would be helpful.

5. Conclusions

The last fifty years have been unusual in human history in that for large parts of the world food has been plentiful and cheap and a low priority for governments and policy makers. The next fifty years will be unusual for other reasons: it is highly likely (but not certain) that human populations will peak while mankind will come to dominate virtually all the biogeochemical cycles including the nitrogen cycle. But though population growth will decelerate there will still be many more (and more

wealthy) mouths to feed, at a time when competition for water and land will be intensive and the effects of climate change becoming stronger. We shall need to moderate demand, reduce waste, and improve the governance food system, but in addition we shall need to grow more but with less effects on the environment. A greater understanding of how nitrogen, in its many forms, can be used to increase yields in ways that do not damage the environment and compromise future food production (and other ecosystem services) will be critical to achieve sustainable food security.

References

- Abbott, P. and de Battisti, A.B. 2011. Recent global food price shocks: causes, consequences and lessons for African governments and donors. *Journal of African Economies* 20, 112-162.
- Anderson, K. 2010. Globalization's effects on world agricultural trade, 1960-2050. *Philosophical Transactions of the Royal Society B-Biological Sciences* 365, 3007-3021.
- Bateman, I.J., Mace, G.M., Fezzi, C., Atkinson, G. and Turner, K. 2011. Economic analysis for ecosystem service assessments. *Environmental & Resource Economics* 48, 177-218.
- Burney, J.A., Davis, S.J. and Lobell, D.B. 2010. Greenhouse gas mitigation by agricultural intensification. *Proceedings of the National Academy of Sciences of the United States of America* 107, 12052-12057.
- Dawson, C.J. and Hilton, J. 2011. Fertiliser availability in a resource-limited world: Production and recycling of nitrogen and phosphorus. *Food Policy* 36, S14-S22.
- Day, W. 2011. Engineering advances for input reduction and systems management to meet the challenges of global food and farming futures. *Journal of Agricultural Science* 149, 55-61.
- Dorward, A. 2011. Getting real about food prices. *Development Policy Review* 29, 647-664.
- Dorward, A. and Chirwa, E. 2011. The Malawi agricultural input subsidy programme: 2005/06 to 2008/09. *International Journal of Agricultural Sustainability* 9, 232-247.
- Dunwell, J.M. 2011. Crop biotechnology: prospects and opportunities. *Journal of Agricultural Science* 149, 17-27.
- Evenson, R.E. and Gollin, D. 2003. Assessing the impact of the Green Revolution, 1960 to 2000. *Science* 300, 758-762.
- Foresight, 2011. *The Future of Food and Farming*. Government Office of Science, London.
- Godfray, H.C.J., Beddington, J.R., Crute, I.R., Haddad, L., Lawrence, D., Muir, J.F., Pretty, J., Robinson, S., Thomas, S.M. and Toulmin, C. 2010. Food security: the challenge of feeding 9 billion people. *Science* 327, 812-818.
- Gornall, J., Betts, R., Burke, E., Clark, R., Camp, J., Willett, K. and Wiltshire, A. 2010. Implications of climate change for agricultural productivity in the early twenty-first century. *Philosophical Transactions of the Royal Society B-Biological Sciences* 365, 2973-2989.
- HMG, 2010. *The 2007/2008 Agricultural Price Spikes: Causes and Policy Implications*. HM Government, London.
- IAASTD, 2008. *International Assessment of Agricultural Knowledge, Science and Technology for Development: Executive Summary of the Synthesis Report*. http://www.agassessment.org/index.cfm?Page=About_IAASTD&ItemID=2.
- International Energy Agency (2012) *World Energy Outlook 2012*. IEA, Paris.
- IPCC, 2007. *Fourth Assessment Report of the Intergovernmental Panel on Climate Change (Contribution of Working Group II)*. Cambridge University Press, Cambridge, UK.
- Lutz, W. and Samir, K.C. 2010. Dimensions of global population projections: what do we know about future population trends and structures? *Philosophical Transactions of the Royal Society B-Biological Sciences* 365, 2779-2791.
- Nelson, G.C., Rosegrant, M.W., Koo, J., Robertson, R., Sulser, T., Zhu, T., Ringler, C., Msangi, S., Palazzo, A., Batka, M., Magalhaes, M., Valmonte-Santos, R., Ewing, M. and Lee, D. 2009. *Climate change : Impact on agriculture and costs of adaptation IFPRI*, Washington DC, USA.
- Nelson, G.C., Rosegrant, M.W., Palazzo, A., Gray, I., Ingersoll, C., Robertson, R., Tokgoz, S., Zhu, T., Sulser, T.B., Ringler, C., Msangi, S. and You, L. 2010. *Food Security & Climate Change, Challenges to 2050*. IFPRI, Washington.
- Paillard, S., Treyer, S. and Dorin, B. 2009. *Agrimonde: Scenarios and Challenges for Feeding the World in 2050*. . Quae, Versailles.
- Phalan, B., Onial, M., Balmford, A. and Green, R.E. 2011. Reconciling food production and biodiversity conservation: land sharing and land sparing compared. *Science* 333, 1289-1291.

- Piesse, J. and Thirtle, C. 2009. Three bubbles and a panic: An explanatory review of recent food commodity price events. *Food Policy* 34, 119-129.
- Piesse, J. and Thirtle, C. 2010. Agricultural R&D, technology and productivity. *Philosophical Transactions of the Royal Society B-Biological Sciences* 365, 3035-3047.
- Rosegrant, M.W., Ringler, C., Msangi, S., Sulser, T.B., Zhu, T. and Cline, S.A. (2008) <http://www.ifpri.org/sites/default/files/publications/impactwater.pdf>.
- Royal Society (2009) *Reaping the Benefits: Science and the Sustainable Intensification of Global Agriculture*. Royal Society, London, UK.
- Smil, V. 2001. *Feeding the World. A Challenge for the Twenty-First Century*. MIT Publications, Boston.
- Stern, N. 2007. *The Economics of Climate Change*. Cambridge University Press, Cambridge, UK.
- Strzepek, K. and Boehlert, B. 2010. Competition for water for the food system. *Philosophical Transactions of the Royal Society B-Biological Sciences* 365, 2927-2940.
- Swinnen, J. and Squicciarini, P. 2012. Mixed messages on prices and food security. *Science* 335, 405-406.
- Tilman, D., Balzer, C., Hill, J. and Befort, B.L. 2011. Global food demand and the sustainable intensification of agriculture. *Proceedings of the National Academy of Sciences of the United States of America* 108, 20260-20264.
- United Nations, 2009. *The Millennium Development Goals Report*. United Nations, New York.
- Vitousek, P.M., Aber, J.D., Howarth, R.W., Likens, G.E., Matson, P.A., Schindler, D.W., Schlesinger, W.H. and Tilman, D. 1997. Human alteration of the global nitrogen cycle: Sources and consequences. *Ecological Applications* 7, 737-750.
- Wiggins, S. and Brooks, J. 2010. <http://www.oecd.org/dataoecd/50/35/46340359.pdf>.
- World Bank (2008) *World Development Report 2008: Agriculture for Development*. World Bank, Washington, USA.

Nitrogen and food security in the European Union from a global perspective

Grinsven, H.J.M. van^a, Westhoek, H.J.^a, Bouwman, A.F.^a, Erisman, J.W.^b

^aPBL Netherlands Environmental Assessment Agency, The Hague, The Netherlands

^bLouis Bolk institute for international advice and research on sustainable agriculture, nutrition and health care, Driebergen, The Netherlands

1. Background & Objectives

Future food security is determined by our ability to accommodate agricultural production with the increase of world population and the change to diets richer in protein. Opportunities to increase the agricultural area are limited because of competing claims by biodiversity conservation, energy cultivation and urbanisation. Increasing nitrogen (N) intensity has been a major factor in increasing agricultural productivity per hectare in the past and hence saving land. But as a consequence N pollution from agriculture has become a major problem from the local to the global scale. This compellingly demands for an increase in N efficiency of agricultural production and diets. The common agricultural policy (CAP) has helped Europe to achieve food security and self sufficiency for most commodities. The European Union (EU) Environmental Directives have lead to an increase in nitrogen efficiencies in European agriculture from 1980 onwards. As a consequence, N pollution from agricultural sources has decreased slowly. However, improvements are stagnating and most environmental targets are not within reach.

This paper analyses the role of N in achieving food security and causing environmental impacts, focusing on Europe. It further explores options to maintain European and global food security while minimizing loss of welfare due to environmental damage.

2. Materials & Methods

This paper synthesises results from recent global assessments by UNEP, IPCC, OECD and IAASTD summarized in Kok et al. (2008), additional scenario analyses building on these assessments focussing on N and agriculture, the European Nitrogen Assessment (Sutton et al., 2011) and an analysis of the European protein puzzle (Westhoek et al., 2011).

3. Results & Discussion

Global setting

In the UN reference scenario the world population will increase from 7 billion in 2011 to 9 billion in 2050. Between 2000 and 2050 total global caloric intake is expected to increase by 65% and the average global consumption of animal products is expected to double (Stehfest et al., 2009). This compelling demand on the global food system will require an increase in the production of cereals in 2050 by about 60%. The share of feed cereal needed for livestock production will remain at one third. The total area of agricultural land is expected to increase between 2000 and 2050 from 47 to 53 million km² (Vuuren and Faber, 2009) with 65% in use for grassland and 10% for feed crops. Accounting for about 5% of land use in 2050 for energy cultivation (Bouwman et al., 2010), the 60% increase in cereal production has to be delivered mainly by an increase of productivity per hectare. An average annual increase by 1% would suffice but achievement is at risk. Between 1970 and 2010 the annual increase of wheat productivity decreased from values over 3% to just above 1% globally and less than 1% in Europe and the U.S.A (Dixon, 2009).

Nitrogen and agricultural productivity

Nitrogen fertilizer has been a key factor for increasing food production, which has been demonstrated for a long time. Cereal yields in Europe increased from 1.2 ton ha⁻¹ in 1900 to around 4 ton ha⁻¹ in the first decade of the 21st century and is in line with results for continuous wheat trials at Rothamsted since 1843 (Goulding, 2008). A factor of four is also the present

difference between the lowest and highest mean wheat yield per hectare in member states of the EU27 (Jensen et al., 2011). However, this recurring factor of four is coincidental as the effect of nitrogen on yield is mixed with effects of local growing conditions, improved plant breeding, irrigation, pest control, availability of other nutrients, and overall improvement of farm management. Using various information sources, Erisman et al. (2008) estimated that mineral N-fertilizer is responsible for about 30-50% of global crop yield increases and may feed almost half of the present world population. Nitrogen can clearly save land, however, such estimates should be viewed with some caution. In part they depend on changing insights on potential crop yields in the absence of mineral N fertilizer and options to close the yield gap. Ponti et al. (2012) estimated the average yield gap between organic and conventional arable agriculture at 20%. Offerman and Nieberg (2000) concluded a similar yield gap between organic and conventional dairy farming.

Nitrogen and animal production

Meat and dairy consumption in the EU has increased steadily in the past 50 years from 25 kg of protein per capita in 1960 to over 30 kg in 2007. Consumption of meat is twice the world average and consumption of dairy products exceeds the world average by a factor of three (Westhoek et al., 2011). Total protein consumption per capita in Europe exceeds the recommendation by the World Health Organization by 70%. Over consumption of (red) meat increases the risk of intestinal cancers and over consumption of saturated fatty acids from animal products increases risks for cardiovascular health (Westhoek et al., 2011).

Modern industrial livestock farming has increased the efficiency of conversion of animal feed to human food to 2-3 kg feed per kg eggs or poultry meat and to 3-4 kg feed per kg pork (Lesschen et al., 2011). As a result land demand for feed has slowed down, but yet feeding European livestock presently requires 125-140 million ha of land, and an additional 10-14 million ha outside Europe related to import of protein and oil rich feed stuffs. Of the feeding area in the EU about half is grassland and half is (mainly) for feed cereals and silage maize. Arable land use for food and animal feed are about equal. The average EU diet requires 0.4 ha per capita, 0.3 ha of this is for animal products.

Land use per sector in EU27, 2005

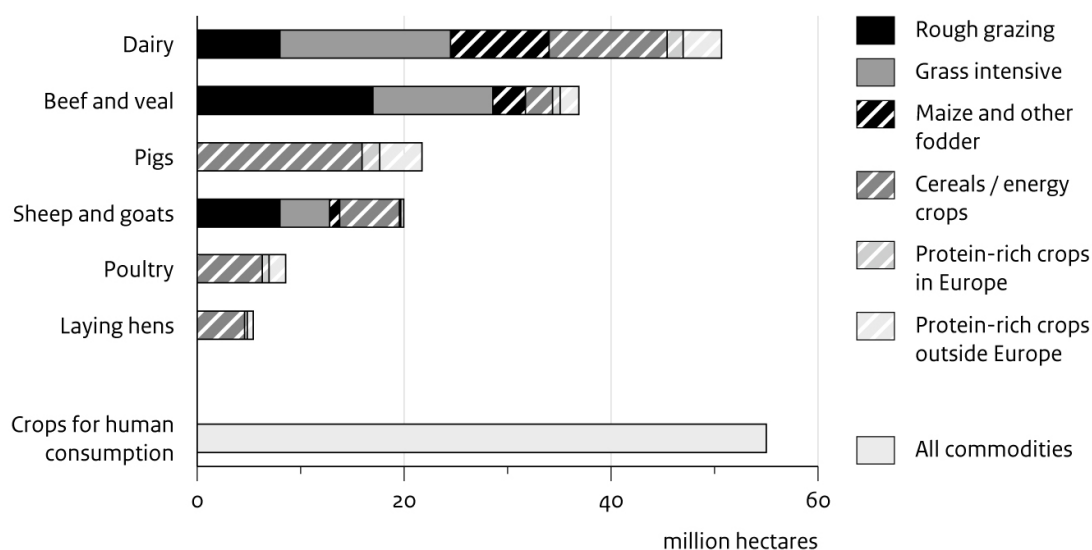

Figure 1. Land use in EU27 in 2005 to feed livestock (Westhoek et al., 2011)

Nitrogen and environment

Nitrogen loss to the environment is a, partly inevitable, consequence of production and consumption of food and energy. Typically, nitrogen use efficiencies for arable production in Europe average around 40% (Goulding et al., 2008). Protein (or N) conversion efficiencies in livestock production range from 20-50% for poultry products, 15-30% in pork and dairy and 5-13% in beef (Sutton et al., 2011). This implies that consumption of protein in animal production involves a large indirect consumption of proteins in feed, and through that of nitrogen inputs to produce the feed crops, and of the associated N pollution. The total input of reactive N to agriculture in the EU27 in 2000 was nearly 14 Tg, mainly in the form of chemical N fertilizer (Sutton et al., 2011). This input constitutes 75% of the total input of reactive N. About 40% of the total input is emitted to air as NH₃, NO_x and N₂O, while 50% is lost to water. As a result N pollution from agricultural sources has become the dominant cause of coastal eutrophication and depletion of stratospheric ozone, and significantly contributes to air pollution, drinking water pollution, freshwater eutrophication, biodiversity loss and disruption of the greenhouse balance.

Nitrogen and welfare

Nitrogen contributes to welfare by increasing agricultural productivity and allowing protein rich diets and for some regions export of agricultural products. The total value of agricultural production (including industrial processing) in 2000 in the EU27 amounted to more than 300 billion euro/yr, of which about 40% (120 billion euro/yr) could be attributed to nitrogen. On the other hand environmental pollution creates a welfare loss. The total damage (or external) cost for the EU related to agricultural emissions of nitrogen was estimated at 25-145 billion euro/yr (Fig. 2; Brink et al., 2011) and appears to be in the same range as the (direct) economical benefits of nitrogen. Damage cost estimates are based on surveys on willingness-to-pay to prevent environmental impacts of nitrogen and need further debate in view of large uncertainties and conceptual issues.

Environmental costs of nitrogen in EU27, 2000

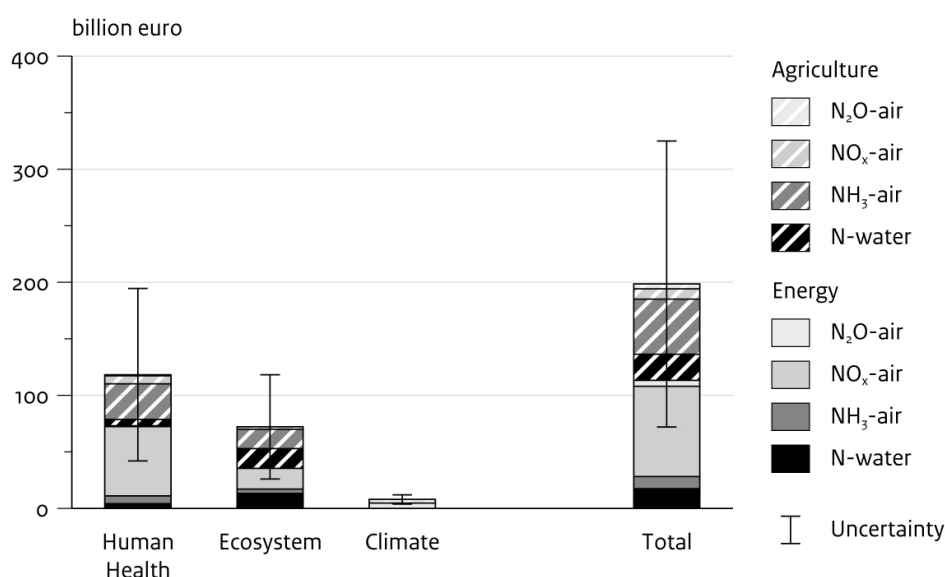

Figure 2. Welfare loss due to environmental damage in the EU27 in 2000 caused by nitrogen emission from agricultural production and energy generation

An insight into diets and agricultural production processes, when combined with external costs, allows the calculation of the N footprint of individual consumption (Leach et al., 2011). The cost of N damage and N footprints are novel ways to communicate N pollution to a larger audience and help to find new optimums for N management in agriculture and the food system at large.

Future nitrogen use

Because of the many uncertain drivers and factors, global use of N fertilizer in 2050 in recent scenario studies (Bouwman et al., 2009, 2011; Erisman et al., 2008) is also very uncertain. Relative to 2000, it ranges between a doubling and a small decrease. In contrast, for Europe these scenarios show a consolidation in the use of N fertilizer and a small increase in manure production, together with a modest increase in nutrient use efficiencies. A worst case scenario for global food security and N pollution would be a shift to global animal protein rich diets combined with high ambitions for land and N demanding energy cultivation. This could result in the skyrocketing of global food and fertilizer prices. An alarming recent observation is that N fertilizer use has increased by more than 25% between 2000 and 2009, and now is at the level that was predicted by FAO for 2030 (Bruinsma, 2003). Equally alarming are the sharp increases and strong variations in food and fertilizer prices since 2008.

Nitrogen challenges and options for Europe

Challenges to maintain European and global food security while minimizing loss of welfare due to N pollution, are increasing nutrient use efficiency, consolidating agricultural land area and changing diets. Reducing food waste, amounting to 30% globally and in Europe, appears to be an easy and no regret first priority but waste is deeply embedded in the food chain and in consumer behaviour (Gustavsson et al. 2011). Complicating factors not yet included in most scenarios are the effects of climate change on agricultural production, and particularly for Europe, stricter demands on animal welfare, human health risks and use of antibiotics, which will likely decrease feed conversion efficiencies (Westhoek et al., 2012).

A great opportunity for the EU is smart development of agriculture in the new central and eastern member states or in the western states of the FSU. For example Romania and Bulgaria hold about 20% of the agricultural land in the EU27, while productivity and nitrogen intensity and environmental cost are still low (Jensen et al., 2011). A well integrated EU food and N policy would stimulate a transition from economical (or private) optimal N fertilizer rates to economical and environmental (or societal) optimal rates (Brink et al. 2011; Good and Beatty, 2011). Using N damage costs from Brink et al. (2011) this optimal societal nitrogen fertilization rate for winter wheat in northwest Europe, would be 30-90 kilogram/ha (median 55 kilogram/ha; 30%) lower than current recommended rates. The concurrent reduction in cereal yield according to conventional nitrogen response curves would be 1-2 tonnes per hectare and compromise food security. However, in view of the recent findings by Ponti et al. (2012), this yield loss due to lower inputs of mineral nitrogen could be compensated to a large extent by adapting nutrient conservation and cycling practices of organic farming. Alternatively, this yield loss may be compensated by increased production in new member states of the EU27. A transition to productive and nitrogen efficient European agriculture would involve long term targets and short term incentives for increasing nitrogen use efficiencies, combined with a vision on the future optimal structure and spatial layout of agricultural production.

4. Conclusion and recommendations

Theoretically, there is ample potential to achieve a future nitrogen efficient, less polluting, secure food system, because of the large potential to increase the land and nitrogen efficiency

in the production, distribution and consumption of food. A strategy for realization involves both better governance and technological and management innovations in the agro-food system. Global competition between land for food, feed, biodiversity or bioenergy is settled in trade and energy policies. Development of more efficient and less polluting production systems for food, feed and bioenergy, is stimulated by targeted public-private funding while actual implementation can be enhanced by smart payment schemes, certification and agreements between large players in the food and energy chain. To find a better balance between increasing productivity and reducing pollution of agricultural production we need a welfare oriented approach appreciating both internal and external costs of the food system. We need to identify the critical components of the food chain, where improvement can make a difference for the system as a whole. For Europe there is a large potential to improve management of manures. Perhaps the greatest challenge is to change human diets to decrease the individual land and N footprint. In 2050 new foods like proteins from aquaculture, or insects, may solve part of the problem. However, a transition to more resource efficient diets in the industrialized part of the world has more potential. A global general increase of prices for resource intensive food products may do part of the job but will increase food inequality. Therefore, convincing consumers to eat less meat by communicating the associated health benefits may be a better strategy.

References

- Bouwman, A.F. Grinsven, J.J.M. van, and Eickhout, B. 2010. Consequences of the cultivation of energy crops for the global nitrogen cycle, *Ecological Applications* 20, 101-109.
- Bouwman, A.F., Beusen, A.H.W. and Billen, G. 2009. Human alteration of the global nitrogen and phosphorus soil balances for the period 1970-2050. *Global Biochem. Cycles* 23
- Bouwman, A.F., Klein Goldewijk, K., Van der Hoek, K.W., Beusen, A.H.W., Van Vuuren, D.P., Willems, W.J., Rufino, M.C. and Stehfest E. 2011. Exploring global changes in nitrogen and phosphorus cycles in agriculture induced by livestock production over the 1900-2050 period, *PNAS Early Edition*.
- Bruinsma, J.E. 2003. *World agriculture towards 2015/2030. An FAO perspective*. Earthscan London.
- Dixon, J., Braun H.J., Kosina P. and Crouch J. (eds.), 2009. *Wheat facts and futures 2009*, Mexico, D.F.: CIMMYT.
- Brink, C., Grinsven, J.J.M. van, Jacobsen, B.H., Rabl, A., Gren, I.-M., Holland, M., Klimont, Z, Hicks, K., Brouwer, R., Dickens, R., Willems, J., Termansen, M., Velthof, G., Alkemade, R., Oorschot, M. van and Webb J. 2001. Costs and benefits of nitrogen in the environment In: Sutton, Howard et al. (eds.) *European Nitrogen Assessment*, Cambridge University Press, London, 513-540.
- Erismann, J.W., Sutton, M.A., Galloway, J., Klimont, Z. and Winiwarter, W., 2008. How a century of ammonia synthesis changed the world. *Nature Geoscience* 1, 636-639.
- Good, A.G. and Beatty, P.H., 2011. Fertilizing nature: a tragedy of excess in the commons, *PLoS Biology* 9.
- Goulding, K., Jarvis, S. and Whitmore, A. 2008. Optimizing nutrient management for farm systems, *Phil.Trans. R. Soc. B*, 363, 667-680.
- Gustavsson, J., Cederberg, C., Sonesson, U., Otterdijk, R. van, Meybeck, A., 2011. *Global food losses and food waste*. FAO, Rome.
- Kok, M.J.T., Bakkes, J.A., Eickhout, B., Manders, A.J.G., Oorschot, M.M.P van, Vuuren, D.P. van, Wees, M. van. and Westhoek H.J. 2008. Lessons from global environmental assessments, PBL-Netherlands Environmental Assessment Agency, Bilthoven pp.74.
- Leach, A.M., Galloway, J.N., Bleeker, A., Erismann, J.W., Kohn, R. and Kitzes, J. 2012. A nitrogen footprint model to help consumers understand their role in nitrogen losses to the environment, *Environ. Developm.* 1, 40-66.
- Lesschen, J.P., Berg, M. van den, Westhoek H.J., Witzke, H.P. and O.Oenema. 2011. Greenhouse gas emission profiles of European livestock sectors, *Anim. Feed Sci. Technol.* 166, 16-28.
- Offermann, F. and Nieberg, H., 2000. Economic Performance of Organic Farms in Europe. In: *Organic Farming in Europe: Economics and Policy*, Volume 5. University of Hohenheim, Department of Farm Economics, Stuttgart, Germany.
- Ponti, T de, Rijk, B. and Ittersum, M.K. de. 2012. The crop yield gap between organic and conventional agriculture. *Agricult. Systems* 108, 1-9.
- Stehfest, E., Bouwman, A.F., Vuuren, D.P. van, Elzen M.G J. den, Eickhout, B. and Kabat, P. 2009. Climate benefits of changing diet, *Climatic Change* 95, 83-102

- Jensen, L.S., Schjoerring, J.K., Van Der Hoek, K.W., Poulsen, H.D., Zevenbergen, J.F., Palliere, C., Lammel, J., Brentrup, F., Jongbloed, A.W., Willems, W.J. and Grinsven, J.J.M. van, 2011. Benefits of nitrogen for food, fibre and industrial production. In: Sutton, Howard et al. (eds.) European Nitrogen Assessment, Cambridge University Press, London, 32-61.
- Sutton M.A.E., Howard C.M., Erisman J.W., Billen G., Bleeker A., Grennfelt P., Grinsven J.J.M. van, and Grizzetti B. 2011. The European Nitrogen Assessment; sources effects and policy perspectives: Cambridge University Press, London pp. 612.
- Vuuren, D.P., Faber, A. 2009. Growing within limits. A report to the global assembly 2009 of the Club of Rome. PBL-Netherlands Environmental Assessment Agency, Bilthoven pp.126.
- Westhoek, H.J., Rood, G. A., Berg van den, M., Janse, J.H, Nijdam, D.S., Reudink, M.A. and Stehfest, E.E. 2011. The Protein Puzzle: The Consumption and Production of Meat, Dairy and Fish in the European Union, European PBL-Netherlands Environmental Assessment Agency, Bilthoven pp.218.

The Nitrogen footprint of European food production

Lesschen, J.P.^a, Leip, A.^b, Wagner, S.^{a,c}, Westhoek, H.J.^c, Oenema, O.^a

^a Alterra, Wageningen-UR, Wageningen, Netherlands

^b European Commission - Joint Research Centre, Institute for Environment and Sustainability, Ispra, Italy

^c PBL - Netherlands Environmental Assessment Agency, Bilthoven, Netherlands

1. Background & Objectives

There are increasing concerns about the ecological footprint of global food production. Research shows that high rates of meat and dairy consumption in human diets could have adverse effects on the environment, through losses of reactive nitrogen. Lowering of meat and dairy consumption could have various beneficial effects, including a substantial lowering of the societal cost for mitigation of NH₃ and greenhouse gas emissions. Firstly, we assessed the Nitrogen (N) footprint for twelve agricultural food commodities, of which six are animal products (dairy, beef, pork, eggs, poultry and lamb and mutton) and six crop products (cereals, potato, fruit and vegetables, sugar, vegetable oils and pulses) in the EU-27. Secondly, we assessed the total reactive N emissions for scenarios in which a reduction in consumption of animal products and proportional reduction in animal numbers were simulated for the EU-27.

2. Materials & Methods

The MITERRA-Europe model was used to calculate N emissions from agriculture following a life-cycle approach to the farm-gate. MITERRA-Europe (Velthof et al., 2009; Lesschen et al., 2011) is an environmental assessment model that calculates annual nutrient flows and GHG emissions from agriculture in the EU-27. Main input data were derived from CAPRI (crop areas, livestock distribution, feed inputs), GAINS (animal numbers, excretion factors, NH₃ emission factors), FAO statistics (crop yields, fertilizer consumption, animal production) and IPCC (CH₄, N₂O, CO₂ emission factors). NH₃, N₂O, NO_x emissions and N leaching and runoff were calculated from the following sources: housing and manure management, application of manure and mineral fertilizers, deposition of manure by grazing animals, use of fossil fuels, manufacture of mineral fertilizer, indirect N₂O emissions from atmospheric volatilization and leaching and cultivation of organic soils. The N footprint is expressed as the sum of these reactive N emissions on a per kg product basis. We assessed a 25% and 50% reduction in 1) beef and dairy and 2) pig, poultry and egg consumption and production and the combination of these two scenarios. For the reduction in feed intake we first reduced the amount of imported feed (mainly oil meals), whereas the cereal use was adjusted to match the remaining energy demand. Reductions in fodder intake were mainly obtained by conversion of temporary grassland and fodder maize areas into cereals. Crop production is no longer used in EU-27, as feed or additional food, is assumed to be exported.

3. Results & Discussion

Figure 1 shows the N footprint for the 12 food commodities. Total reactive N fluxes are about 200 g N per kg product for ruminant meat, about 50 g N per kg product for pork and poultry meat and about 15 g N per kg product for dairy products. The differences are smaller when expressed on a per kg protein basis. All crop products have (much) lower total fluxes of reactive nitrogen than animal products. N leaching and runoff and NH₃ emissions are the main losses of reactive N. Among EU countries there is a large variation in the N footprint, although this is lower for crop production compared to animal production.

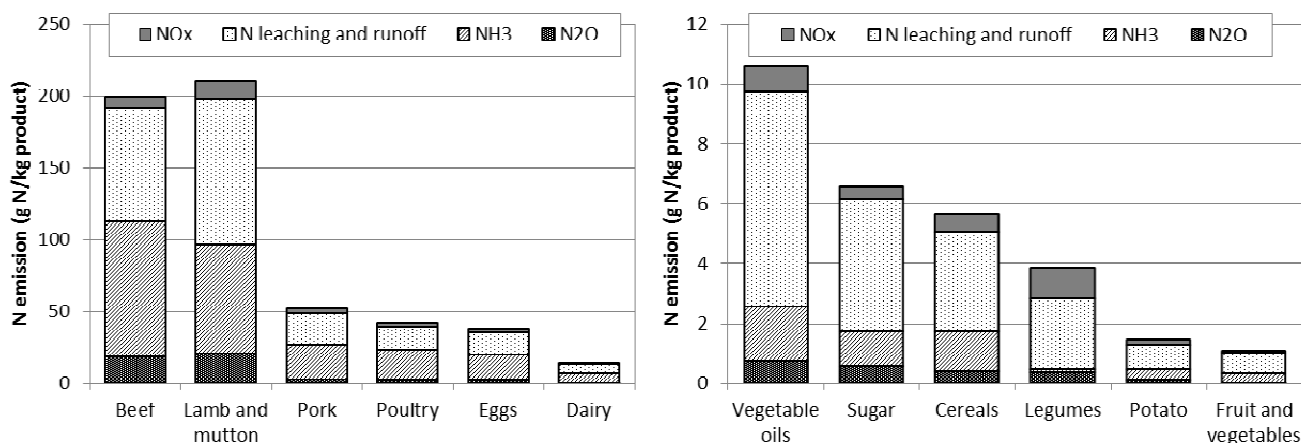

Figure 1. N footprint for six animal products and six crop products for the EU-27

In Figure 2 the reduction in reactive N emissions is shown for the different scenarios. A reduction in beef and dairy consumption and the consequent decrease in cattle numbers results in a greater % reduction in emissions compared to a reduction in pigs and poultry. The largest effect is on NH₃, since N₂O and N leaching and runoff are reduced less due to continuing emissions from the arable sector.

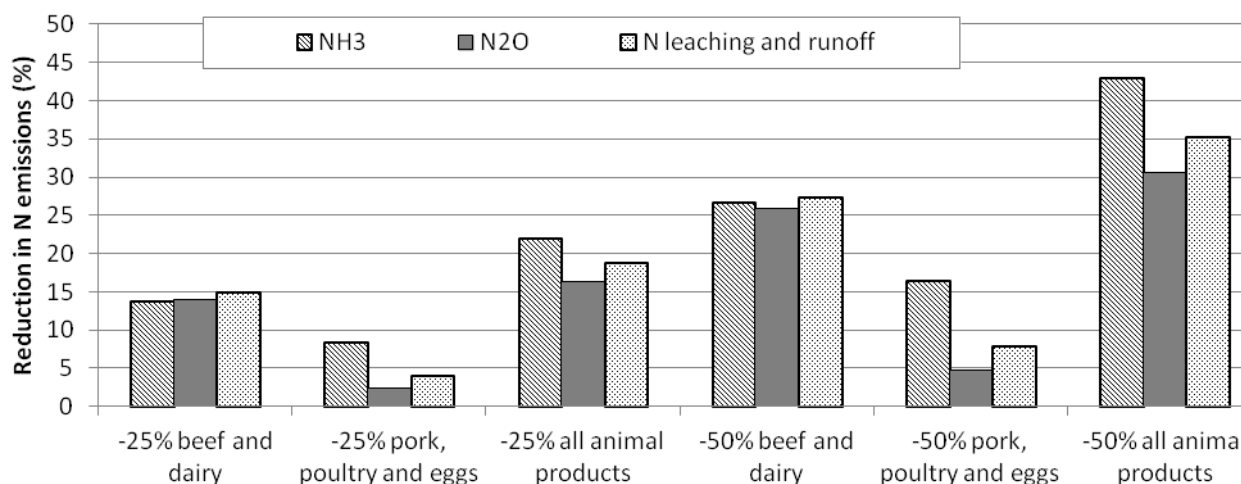

Figure 2. Reduction in EU-27 total NH₃ and N₂O emission and N leaching and runoff for different scenarios with reduced consumption of animal products

4. Conclusion

Our study shows that there are large differences in the N footprint between food commodities. A decrease in consumption of animal products and a proportional reduction in animal numbers can result in a large reduction in reactive N emissions in the EU-27.

References

Lesschen J.P., van den Berg M., Westhoek H.J., Witzke H.P. and Oenema O. 2011. Greenhouse gas emission profiles of European livestock sectors. *Animal Feed Science & Technology* 166-167, 16-28.

Velthof G.L., Oudendag D., Witzke H.P., Asman W.A.H., Klimont Z., Oenema, O. 2009. Integrated assessment of nitrogen emissions from agriculture in EU-27 using MITERRA-EUROPE. *J. of Environ. Quality* 38, 402-417.

The product carbon footprint of milk from pasture- and confinement-based dairy farming

Schönbach, P., Biegemann, T., Kämper, M., Loges, R., Taube, F.

Institute of Crop Science and Plant Breeding (Grass and Forage Science), University of Kiel, Germany

1. Background & Objectives

Grassland and forage crops account for more than 50% of the total agricultural area in Schleswig-Holstein (Germany). In recent decades, dairy farming has been subjected to ongoing intensification resulting in less pasture grazing in favour of high-input confinement systems. The present study aims to answer a) How does the management system affect the product carbon footprint (PCF) of milk? b) What are the main sources of greenhouse gases (GHGs) in the milk production chain? c) Which are the most promising GHG mitigation options? The results presented here are preliminary calculations considering only the currently available dataset of 2010 (2011 is still in progress).

2. Materials & Methods

The PCF of milk from two contrasting, well-managed dairy farms was assessed by quantifying GHGs along the milk production chain from cradle to farm gate (combination of life-cycle-assessment method with field-level measurements). According to their global warming potential of 1, 25 and 298 emissions of CO₂, CH₄ and N₂O were summed up and referred to the functional unit (1 kg of energy corrected milk (ECM)) to determine the PCF milk of two dairy farms: a) a pasture system (PS) with year-round rotational grazing and an annual use of 200 kg of concentrates to produce on average 5 900 kg milk cow⁻¹ year⁻¹; b) a confinement system (CS) with year-round indoor housing and an annual use of 3 500 kg of concentrates to produce 11 200 kg milk cow⁻¹ year⁻¹. GHGs from forage areas and pastures were measured at the field-level. Both farm-level GHG emissions associated with animal and manure management and upstream-chain or pre-farm GHG emissions associated with the input and use of resources were estimated by using operating data of farms and standard emission factors. The effect of land use on soil C on-farm and off-farm was also considered: a) on-farm by calculating field-scale C balances; b) off-farm by estimating land use change induced C losses. The economic option was chosen to allocate GHG emissions to outputs of milk and meat.

Table 1. Methodological framework of the product carbon footprint of milk.

Sources	Greenhouse gas	Method	Reference	
ON-FARM (field-level)	- Forage production (Maize, permanent grassland, ley)	CH ₄ , N ₂ O CO ₂	Measured Estimated (C balance)	closed chamber method VDLUFA 2004
	- Pasture (grass/clover leys)	CH ₄ , N ₂ O CO ₂	Measured Estimated (C balance)	closed chamber method VDLUFA 2004
ON-FARM (farm-level)	- Enteric fermentation	CH ₄	Estimated (EF*)	Kirchgessner et al. 1991
	- Manure management	CH ₄	Estimated (EF*)	Clemens et al. 2006
	- Use of fossil fuels/electricity	CO ₂ , CH ₄ , N ₂ O	Estimated (EF*)	Patyk & Reinhardt 1997
OFF-FARM (pre-chain)	- Supply of resource inputs (fertilizer, seeds, pesticide, energy, concentrates)	CO ₂ , CH ₄ , N ₂ O	Estimated (EF*)	Biskupek et al. 1997 Patyk & Reinhardt 1997 Eriksson et al. 2005
	- Land use change**	CO ₂	Estimated (EF*)	FAO 2010

*EF, emission factor; **Soil C losses associated with soybean cultivation in South America (FAO 2010)

3. Results & Discussion

The product carbon footprint of milk from PS and CS was similar at 1.1 kg CO_{2eq} kg⁻¹ ECM, if C sequestration and land use change were excluded. However, milk from PS had much lower PCF than milk from the CS, if C sequestration of pastures and land use change induced C losses were included (Figure 1). PCFs were dominated by enteric CH₄ emissions and field-level N₂O emissions

in the PS and by enteric fermentation and the resource inputs in the CS (Figure 1). Taking into account C sequestration of grasslands associated with forage production and pasture grazing considerably improved the PCFs of milk, i.e. total GHG emissions were offset by 48% and 9% at PS and CS, respectively (Figure 1). Animal feeding in CS was essentially based on concentrates and it has therefore been considered necessary to include GHGs related to concentrate components. The loss of soil C through changing land use (grassland/forest to arable land) is particularly associated with soybean cultivation in South America, which significantly worsens the PCF of the high-input CS farm by producing an additional 0.34 kg CO_{2eq} kg⁻¹ ECM (Figure 1).

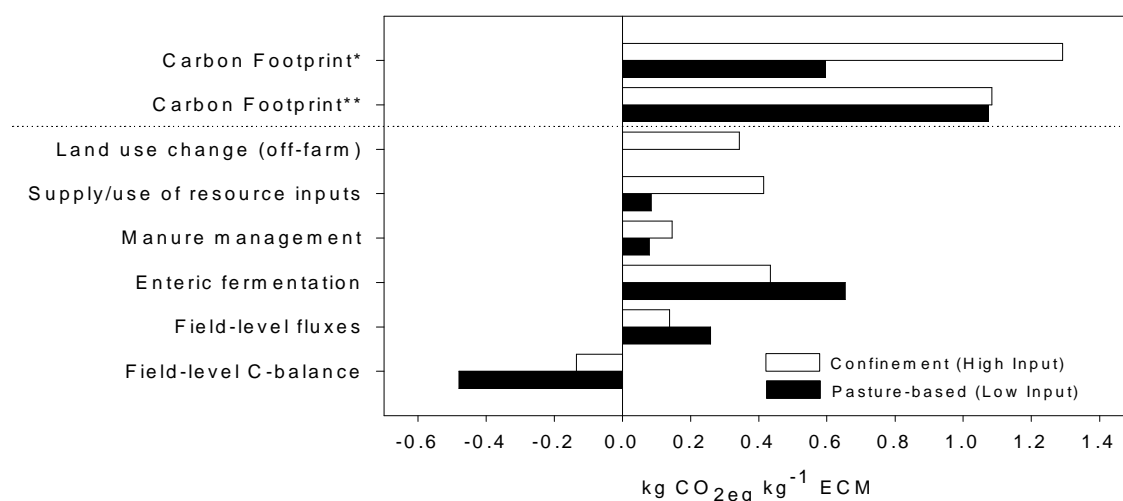

Figure 1. The product carbon footprint (PCF) milk of pasture based and confinement systems before allocation. (*incl. soil C sequestration potential and land use changes. **excl. soil C sequestration potential and land use changes.)

4. Conclusion

The investigated dairy farms exhibited large differences in their PCF of milk, not only regarding total amounts of GHGs but also regarding the contribution of GHG sources. Owing to their potential of sequestering atmospheric CO₂ in grassland soil C stocks, pasture-based systems hold the potential to improve the PCF of milk. However, estimation of soil C sequestration still lacks accuracy and further knowledge and methodological standardization is required to increase the confidence in estimations and to achieve comparability among systems and studies.

References

- Biskupek B., Patyk A., Radtke J. 1997. Daten zur Pflanzenölproduktion. In: *Nachwachsende Energieträger*, Kaltschmitt M., Reinhardt G.A. (Eds). Braunschweig/Wiesbaden. 167-225. (In German)
- Clemens J., Trimborn M., Weiland P. and Amon B. 2006. Mitigation of greenhouse gas emissions by anaerobic digestion of cattle slurry. *Agriculture, Ecosystem & Environment* 112, 171-177.
- FAO. 2010. *Greenhouse Gas Emissions from the Dairy Sector. A Life Cycle Assessment*. Food and Agricultural Organization of the United Nations. Rome.
- Kirchgessner M., Windisch W., Müller H.L., Kreuzer M. 1991. Release of methane and carbon dioxide by dairy cattle. *Agribiol. Res.* 44, 2-3.
- Eriksson I.S., Elmquist H., Stern S. and Nybrant T. 2005. Environmental Systems Analysis of Pig Production - The Impact of Feed Choice. *Int J LCA* 10 (2), 143-154.
- Patyk A. and Reinhardt G. 1997. *Düngemittel-, Energie- und Stoffstrombilanzen*. Braunschweig/Wiesbaden. (In German)
- VDLUFA (2004) *Humusbilanzierung – Methode zur Beurteilung und Bemessung der Humusversorgung von Ackerland*. Verband Deutscher Landwirtschaftlicher Untersuchungs- und Forschungsanstalten. Bonn. (In German)

The effect of nitrogen fertiliser application rate on nitrous oxide emission intensities of arable crop products

Thorman, R.E.^a, Pappa, V.A.^b, Smith, K.^a, Rees, R.M.^b, Chauhan, M.^a, Bennett, G.^c, Denton, P.^d, Munro, D.G.^a, Sylvester-Bradley, R.^a

^aADAS UK Ltd., Battlegate Road, Boxworth, Cambridge, CB23 4NN, UK

^bSAC, West Mains Road, Edinburgh, EH9 3JG, UK

^cADAS UK Ltd., Gleadthorpe, Meden Vale, Mansfield, Nottingham, NG20 9PF, UK

^dADAS UK Ltd., Bentinck Farm, Rhooon Road, Terrington St Clement, King's Lynn, Norfolk, PE34 4HZ, UK

1. Background & Objectives

The demands of feeding a rapidly expanding global population without exacerbating climate change are a major challenge which urgently needs to be addressed. Arable farms in Northern Europe are likely to play an increasingly vital role in food production, but most crops receive significant amounts of inorganic nitrogen (N) fertilisers, which can be associated with large losses of the greenhouse gas (GHG) nitrous oxide (N₂O). In national GHG inventories where direct N₂O emissions from soil are calculated using the standard Tier 1 Intergovernmental Panel on Climate Change (IPCC) methodology (IPCC, 2006) and in current commercial GHG accounting procedures, direct N₂O emissions from soil are assumed to be linearly related to N inputs. This assumption implies that drastic reductions in N fertiliser use and crop productivity would be required to minimise N₂O intensities of crop products (kg N₂O-N per kg product). We hypothesise that the response of annual N₂O emissions to N supply is, to some extent, related to the surplus of N supply over crop N uptake (Figure 1a). If so, fertiliser N application strategies to minimise N₂O emission intensities of crop products may have much less severe implications for crop productivity (Figure 1b).

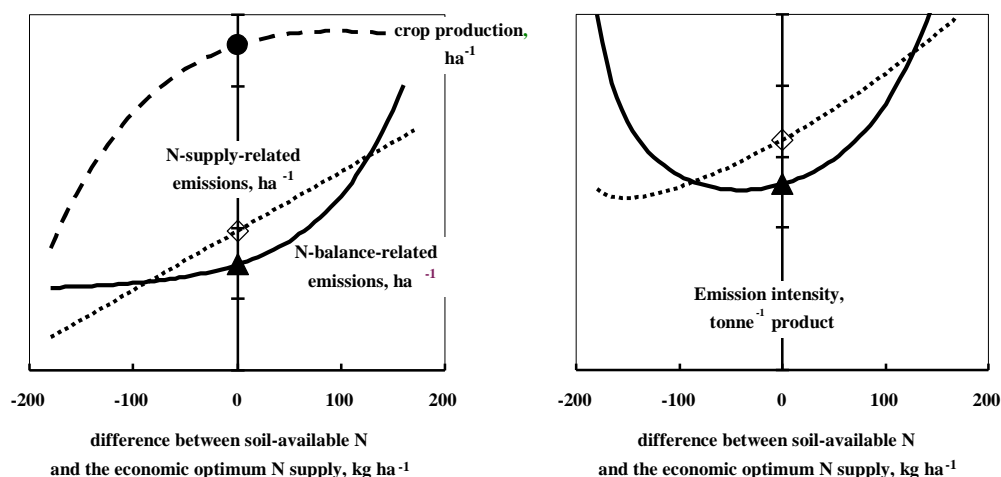

Figure 1. Modelled effects of N supply on (a) crop production (circle), and on N₂O emissions if related directly to N supply (diamond; as estimated by IPCC Tier 1 approach) or to the balance between N supply and crop N uptake (triangle; as hypothesised here), and (b) consequent contrasting effects of these scenarios on N₂O emission-intensities of crop products.

If N₂O emissions are entirely N-balance related, N amounts that minimise N₂O intensities would be similar to current use, with little effect on crop productivity. The ongoing research described here is assessing the shapes of the responses in annual N₂O emissions to increasing amounts of applied N

for the main UK arable crops (cereals, sugar beet and oilseed rape), relating these to economic optimum N amounts for crop production, and suggesting better means of N fertiliser management.

2. Materials & Methods

At four UK sites: 1) south east England (clay loam), 2) south east England (silt loam), 3) central England (loamy sand) and 4) central Scotland (sandy loam), N₂O emissions (5 static chambers/plot) were monitored from replicated (x3) plots for 12 months, following spring ammonium nitrate fertiliser applications in the range nil to 240% of recommended N. Up to three fertiliser applications were made in order to achieve target rates. In the first 2 weeks after each fertiliser application, 7 measurements were taken, decreasing in frequency to give a yearly total of 40-50 measurements. The crops studied were winter wheat (ww) & winter oilseed rape (site 1), ww (site 2), spring barley (sb) & sugar beet (site 3) and ww, sb & winter barley (site 4). Yield measurements were also taken.

3. Results & Discussion

Cumulative direct N₂O emissions from all eight experiments were small and emissions were not generally affected immediately following N fertiliser application due to abnormally dry spring conditions and low soil moisture contents. Significant emissions followed later rainfall events, peak emissions (up to *c.* 70 g N₂O-N ha⁻¹ d⁻¹) being measured up to *c.* 4 months after the last fertiliser had been applied. Total annual emissions ranged from 0.3 to 1.1 kg N₂O-N ha⁻¹ with nil N applied, and calculated emission factor (EFs) for N lost as N₂O at 120% of the recommended N rate (excluding the emission with nil N) were generally <0.30% (all <0.60%) of total N applied, compared to the IPCC Tier 1 (EF) of 1.0% (IPCC, 2006). Despite the apparent delay in N uptake compared to normal conditions, most responses of N₂O emission to N application rate were linear. However, in Central Scotland the response for spring barley was clearly best described by a non-linear relationship while those responses for winter wheat and winter barley tended to show slight non-linearity. The lack of non-linear responses in the majority of experiments is surprising given that the generally dry conditions inhibited emissions soon after N application, and that most peak emissions occurred after the main phase of crop N uptake. It remains to be seen whether more normal dynamics of N application, crop N uptake and N₂O emission will lead to non-linear responses, which will enable an appropriate N applications strategy to be devised to minimise N₂O emissions.

4. Conclusion

The main differences between these results and the assumptions currently used in GHG accounting and the UK GHG inventory are the small EFs in relation to fertiliser N rate. However, the results were affected by a dry spring so cannot yet be considered representative of UK arable conditions. If linear responses prove to be the norm, it may have to be accepted that high crop yields will depend on exceeding minimum direct emission intensities, although if the EF for total N applied is small (say 0.50%), this difference will be slight.

Acknowledgements

This research is sponsored by the UK Department for Environment, Food and Rural Affairs and Scottish Government through Sustainable Arable LINK Project LK09128, and we acknowledge contributions of ADAS, Agricultural Industries Confederation, Bayer CropScience, British Sugar, Country Land and Business Association, The Co-operative Group, Frontier Agriculture, GrowHow UK, AHDB-HGCA, Hill Court Farm Research, NFU, North Energy Associates, PGRO, Renewable Energy Association, Rothamsted Research (North Wyke), SAC, Scotch Whisky Research Institute, SoilEssentials, Vivergo fuels, Warburtons and Yara UK.

References

IPCC. 2006. 2006 IPCC Guidelines for National Greenhouse Gas Inventories. Eggleston H.S., Buendia L., Miwa K., Ngara T., Tanabe K. (eds.). IGES, Japan.

Carbon footprint of Irish milk production: can white clover make a difference?

Yan, M.-J.^a, Humphreys, J.^b and Holden, N. M.^a

¹ UCD School of Biosystem Engineering, University College Dublin, Belfield, Dublin 4, Dublin, Rep. of Ireland

² Animal and Grassland Research and Innovation Centre, Teagasc, Moorepark, Fermoy, Co Cork, Rep. of Ireland

1. Background and objectives

The greenhouse gas (GHG) emissions of dairy production are of considerable concern to Ireland. Carbon footprint (CF) calculated by life cycle assessment (LCA) is a useful tool to trace the global effect of GHG emissions due to local production. The goal of the study was to model the CF of milk, produced from pasture reliant on fertilizer N (FN) and white clover (WC), at the research farmlet scale, and to evaluate the uncertainty of CF when up-scaling. The four stages of LCA methodology were implemented as follows according to ISO 14040.

2. Materials & Methods

The foreground data was based on the comparative experiment at Teagasc Solohead Research Farm for the years 2001-2006 (Table 1; Humphreys et al., 2008; 2009). All cows were Holstein-Friesian breed. The soil on-farm has clay-loam texture and ten-year average rainfall was 1005 mm. The functional unit (FU) was defined as 1 kg energy corrected milk (ECM). The system boundary was set at the farm gate and included relevant pre-farm processes (production and transportation of fertilizer and concentrate feed) and the on-farm production. Soil carbon sequestration, pesticides, medicine, plastic sheets etc. were not included. Economic allocation between milk and meat from surplus calves and culled cows (both 91% for FN and WC) was used applied using average market prices between 2000 and 2006. Emission factors (EFs) were taken from relevant literature while the EF for enteric CH₄ was determined by estimating net energy for maintenance, lactation and pregnancy. Simapro 7.3 was used for the LCA modelling and all background processes (such as fertilizer production) were chosen from Ecoinvent 2.2 database. The "IPCC 2007GWP 100a" was selected to assess the GHGs per FU, which defined that the GWP of CO₂ (time span of 100 years) as 1, of CH₄ as 25, and of N₂O as 298. Ratio sensitivity was performed to assess the impact of the uncertainty of EFs on the comparison between the systems.

Table 1. On-farm activity data of Solohead experiment trials during 2001-2006

Year	WC		FN		WC		FN	
	2001-2002				2003-2006			
Acronym ¹	N205	N230	N300	N400				
Stocking rate ² (LU ha ⁻¹)	1.75	2.10	2.50	2.50	2.00; 2.20	2.00; 2.20		
Synthetic N fertilizer (kg N ha ⁻¹)	80	180	248	353	90	226		
Concentrate feed (kg cow ⁻¹ yr ⁻¹)	536	536	536	536	520	531		
Milk yield (kg cow ⁻¹)	6550	6275	6242	6375	6521	6526		
Milk fat (%)	4.1	4.2	4.1	4.2	4.2	4.2		
Milk protein (%)	3.5	3.6	3.5	3.6	3.5	3.6		

¹ The The acronyms for 2001 and 2002 are consistent with Humphreys et al, 2008; there were no acronyms previously defined for the experiments between 2003 and 2006

² The stocking rate (LU = livestock unit) were 2.00 for 2003 and 2.20 for 2004-2006

3. Results & Discussion

The CF of WC was 11 to 24% lower than FN across the range of fertilizer N input. With physical allocation (85% to milk), the average CF for WC was 0.81 kg CO₂ eq kg ECM⁻¹ and significantly

lower than FN, which was $0.98 \text{ kg CO}_2 \text{ eq kg ECM}^{-1}$ ($P < 0.001$). With economic allocation (91% to milk) the difference was also significant, with 0.87 and $1.05 \text{ kg CO}_2 \text{ eq kg ECM}^{-1}$ respectively. The majority of GHGs were within Ireland and contributed more to WC (85%) than to FN (80%). The contributors that accumulated c. 95% of GHGs were enteric CH_4 (WC: 51% and FN: 43%), excreta deposition (WC: 13%, FN: 11%), fertilizer spreading (WC: 6%, FN: 12%), fertilizer production (FN: 10%), electricity production (WC: 8%, FN: 6%), indirect N_2O (both 6%), slurry storage (WC: 4%, FN: 3%), concentrate production (WC: 4%, FN: 3%), and slurry spreading (WC: 3%). Significant correlation was found between surplus N per kg ECM and CF (Figure 1, $R^2 = 0.66$, $P < 0.001$), which indicated that a 1 g reduction of on-farm surplus N could reduce CF by 26 g $\text{CO}_2 \text{ eq}$. A similar relationship (29 g $\text{CO}_2 \text{ eq}$) was reported by Schils et al. (2006). The ratio sensitivity analysis revealed that to reverse the priority of WC and FN, changes to emission factors (EF) and assumptions had to be much greater than the uncertainty range found in the literature. For example, EF of enteric CH_4 in WC needed to be increased by 24 to 59%, but enteric CH_4 from cows fed white clover was found to be similar (van Dorland et al., 2007) to those fed grass, and neither higher gross energy content or a larger methane conversion factor of clover is suggested to be likely (Andrews et al., 2007).

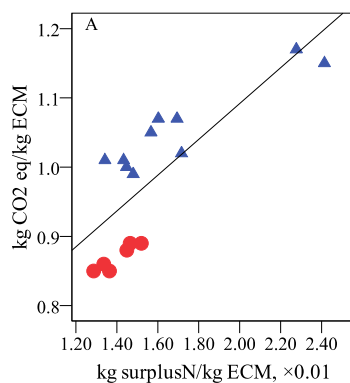

Figure 1. Relationship between on-farm surplus N and CF (economic allocation). Dots: WC; triangles: FN

4. Conclusions

The carbon footprint (CF) of milk production from WC was 11 to 24% lower than from compared with FN swards. Sensitivity analysis showed the model on research farmlets was robust and white clover could reduce greenhouse gas emissions. CF model requires further research on system efficiency, productivity and profitability to translate effects to the national scale.

References

- Andrews, M., Scholefield, D., Abberton, M.T., McKenzie, B.A., Hodge, S. and Raven, J.A. 2007. Use of white clover as an alternative to nitrogen fertilizer for dairy pastures in nitrate vulnerable zones in the UK: productivity, environmental impact and economic consideration. *Annals of Applied Biology* 151, 11-23
- Humphreys, J., O'Connell, K. and Casey, I. A. 2008. *Grass and Forage Science* 63, 467-480
- Humphreys, J., Casey, I. A. and Laidlaw, A. S. 2009. *Irish Journal of Agricultural and Food Research* 48, 189-207
- Schils, R.L.M., Verhagen, A., Aarts, H.F.M., Kuikman, P.J. and Šebek, L.B.J. 2006. Effect of improved nitrogen management on greenhouse gas emissions from intensive dairy systems in the Netherlands. *Global Change Biology* 12, 382-391.
- van Dorland, H.A., Wettstein, H-R, Leuenberger, H. and Kreuzer, M. 2007. Effect of supplementation of fresh and ensiled clovers to ryegrass on nitrogen loss and methane emission of dairy cows. *Livestock Science* 111, 57-69.

Integrated assessment of nutrient management options in the food chain of China

L. Ma^{a,d*}, F.H. Wang^a, W.F. Zhang^a, W.Q. Ma^b, G.L. Velthof^c, W. Qin^d, O. Oenema^{c,d}, F.S. Zhang^a

^aDepartment of Plant Nutrition, China Agricultural University, Key Laboratory of Plant-Soil Interactions, Ministry of Education, Beijing 100094, P. R. China ; ^b College of Resources and Environmental Sciences, Agricultural University of Hebei, Baoding, 071001, China; ^c Alterra, Wageningen University, Wageningen, P.O. Box 47, 6700 AA, the Netherlands; ^dDepartment. of Soil Quality, Wageningen University, Wageningen, P.O. Box 47, 6700 AA, The Netherlands *Presenting author: lin.ma@wur.nl

1. Background & Objectives

Nitrogen (N) and phosphorus (P) costs of food production have greatly increased in China during the last 30 years (Ma et al., 2012). Forecasts suggest that the food demand is rapidly increasing further during the coming decades, and that the N and P costs of the food produced will also increase further. However, these forecasts are not based on rigorous quantitative assessments, taking into account various possible options for a more sustainable nutrient management in the food chain at national and regional levels. Here, we present the results of a scenario analysis for improving nutrient management for the year 2030.

2. Materials & Methods

NUFER is a model developed to calculate the flows, use efficiencies, and emissions of N and P in the food chain of 31 regions in China on an annual basis (Figure 1). It uses a mass balance approach with detailed accounts of the partitioning of N and P inputs and outputs, and of N and P losses via NH₃ and N₂O emissions, denitrification and N and P leaching, runoff and erosion. The N and P use efficiencies of crop production (NUEc, PUEc), animal production (NUEa, PUEa), and food chain (NUEf, PUEf) were defined by the ratio of N and P output in main products and the total input (Ma et al., 2010). Here, mean results for the whole of China are presented.

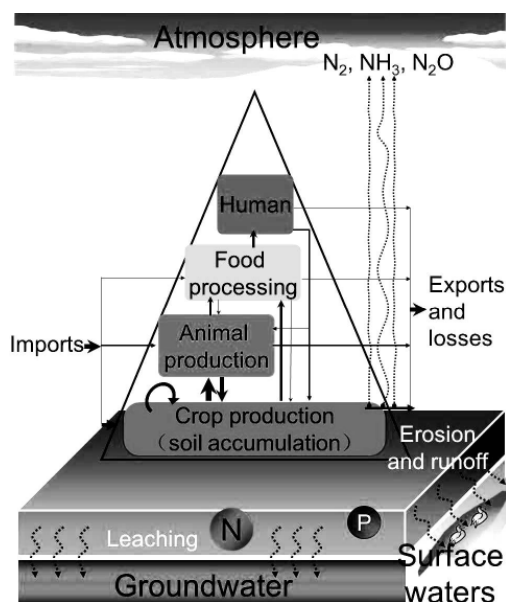

Figure. 1 The N and P flows in the food production-consumption chain

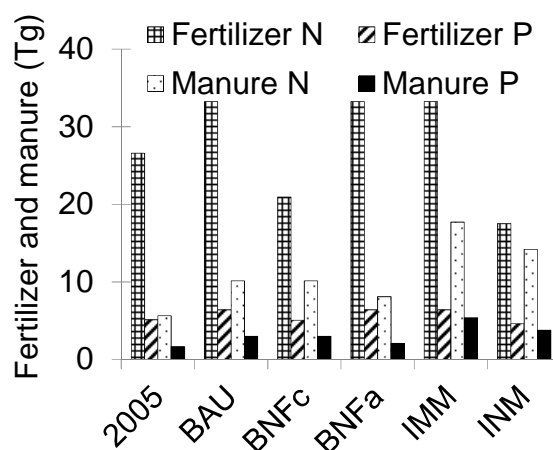

Figure. 2 Use of fertilizer and manure N and P in 2005 and in the 5 scenarios for 2030 (see text for explanation of scenarios).

The five scenarios for 2030 were as follows: (i) Business-as-usual (BAU); (ii). Balanced N and P fertilization in crop production (BNFC); (iii) Balanced N and P feeding in animal production

(BNFa); (iv) Improved manure management (IMM), and (v) Integrated nutrient management (INM = BNFc + BNFa + IMM).

3. Results & Discussion

Figure 2 presents the use of fertilizer and manure N and P in crop production in 2005 and in 2030 for the 5 scenarios. Figure 3 shows the losses of N and P from the food chain, and Table 2 shows the NUE and PUE in crop production, animal production and the whole food chain in 2005 and in 2030 for the 5 scenarios, respectively. Increases in N and P fertilizer use and in N and P losses in the BAU scenario were large relative to 2005. Scenarios BNFc, BNFa, IMM and INM were all effective in decreasing N and P losses, and in increasing NUE and PUE, but in different degrees.

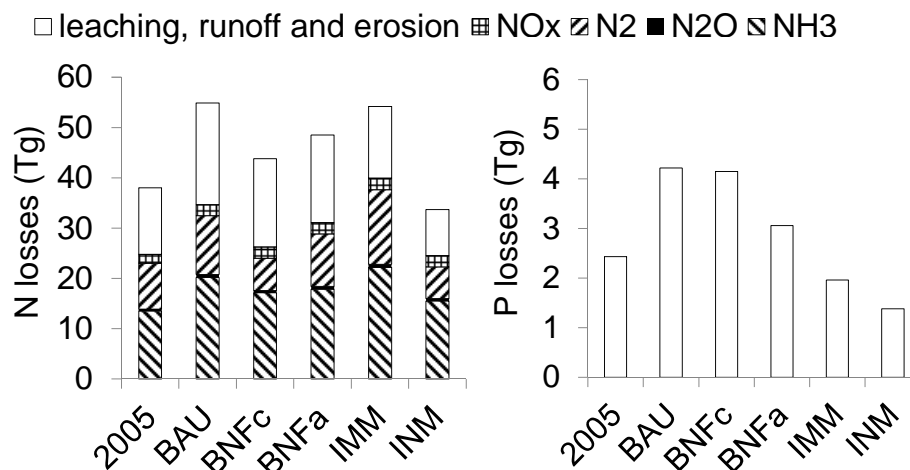

Figure 3. Losses of N and P from crop and animal production in China in 2005, and for the 5 scenarios (see text).

Table 1. NUE and PUE in crop production, animal production and food chain in 2005, and in the 5 scenarios, in %

	2005	BAU	BNFc	BNFa	IMM	INM
NUEc	26	26	36	27	23	34
NUEa	16	16	16	19	16	19
NUEf	9	8	10	9	8	12
PUEc	36	33	38	37	27	37
PUEa	17	17	17	23	17	23
PUEf	7	6	6	7	6	9

The scenario BAU suggests dramatic increases in N and P losses for the year 2030 relative to 2005. Balanced N and P fertilization (BNFc) is the most effective single measure for increasing NUE and PUE (Table 1), while improved manure management (IMM) is the most effective single measure to decreasing nutrient losses, especially for P.

4. Conclusion

Implementation of a package of integrated nutrient management measures (INM) would more than nullify the expected increases in estimated losses in the BAU scenario, and would greatly increase NUE and PUE in the whole food chain.

References

- Ma, L., Ma, W. Q., Velthof, G. L., et al., 2010. Modeling Nutrient Flows in the Food Chain of China. *Journal of Environmental Quality* 39(4), 1279-1289.
- Ma, L., Velthof, G. L., Wang F. H., et al., 2012. Nitrogen and phosphorus use efficiencies and losses in the food chain in China at regional scales in 1980 and 2005. *Science of total environment* (in press).

3 SESSION

Global Perspectives on Nitrogen and Food Security

Poster Presentations

Carbon footprint of Irish milk production

Yan, M.-J.^a, Humphreys, J.^b and Holden, N. M.^a

^aUCD School of Biosystem Engineering, University College Dublin, Belfield, Dublin 4, Dublin, Rep. of Ireland

^bAnimal and Grassland Research and Innovation Centre, Teagasc, Moorepark, Fermoy, Co Cork, Rep. of Ireland

1. Background and objectives

There is an established concern about the effect of greenhouse gas (GHG) emissions on global climate change. In Ireland, agriculture is the single largest contributor to overall emissions at 26% (EPA, 2010). A holistic method, Life Cycle Assessment (LCA), can better reveal the environmental impacts of an agricultural system. The LCA interpretation of GHG emissions is also referred to as carbon footprint (CF). CF of milk production has been carried out on commercial farms in Europe either with statistics or with once-off surveys, where the farm-gate turnover was used, and the main theme was to compare production mode (i.e. organic Vs. conventional). However, it can be argued that production mode may not necessarily indicate higher or lower CF and multiple management strategies may need to be adopted by farmers according to their own circumstances. The objective of this paper was to estimate the CF of Irish milk production at commercial dairy farms according to methodology defined by ISO 14040.

2. Materials & Methods

The LCA model was developed with MS® EXCEL 2007. The system boundary was set at the farm gate and included relevant pre-farm processes (production and transportation of fertilizer and concentrate feed) and the on-farm production. Soil carbon sequestration, pesticides, medicine, plastic sheets etc. were not included. In order to exclude other enterprises (e.g. cattle rearing) on the commercial farms and only include the “dairy-unit”, a self-defined proportionate rule was performed. This was done by 1) converting all animals into livestock unit (LU) equivalence according to the ratio of nitrogen excretion against a dairy cow as defined in Statutory Instruments No. 610 (2010); 2) assuming the dairy herd consisted of dairy cows + replacement animals + bulls or suckler cows (if any), deriving the proportion factor of dairy herd as dairy LU/total LU; and 3) excluding from the farm GHG inventory the GHG associated with electricity production, which was predominantly used by dairy herd, and multiply the rest with the proportion factor, and then adding up GHG associated with electricity production to derive the dairy unit GHG. Proportionate, economic allocation between milk and meat was performed based on farm sale records.

The foreground data was based on a one-year survey with a small group of specialist dairy farms (Table 1), and the background data were taken from Ecoinvent database. The functional unit (FU) was defined as 1 kg energy corrected milk (ECM). Economic allocation was used for concentrate feed ingredients at the pre-farm stage. Emission factors (EFs) were taken from relevant literature while the EF for enteric CH₄ was determined by estimating net energy (NE) for maintenance, lactation, and pregnancy. Global warming potential of CH₄ and N₂O was taken as 25 and 298 times CO₂ equivalent.

Table 1. Characterization data of the dairy unit among the 18 dairy farms in the survey

	Mean	CV%
Grassland, ha	67	32
Grassland stocking rate, LU/ha	2.2	17
Synthetic fertilization rate, kg N/ha	205	29
Diesel use, L/ha	41	22
Electricity use, kWh/t milk	87	31
# of Dairy cows	102	29
Milk delivered, kg/cow	5700	12
Milk fat, %	4.2	4
Milk protein, %	3.5	4
Concentrate feed, kg/cow	958	27

Large variation among farm management was found. For example, stocking rate varied from 1.5 to 2.8 LU ha⁻¹, fertilization rate from below 150 to above 250 kg N ha⁻¹. However, the CF of milk among the farms only had a CV of 13%, with an average of 1.23 kg CO₂ eq kg ECM⁻¹. Geographically, 80% of the total GHGs were from on-farm. The single largest contributor was enteric fermentation (43%), followed by excreta deposition and fertilizer spreading (both 11%), manure storage and fertilizer production (both 10%), concentrate feed production (6%), manure spreading (4%), electricity production (3%), field work and transportation (both 1%). These were in general agreement with previous studies on commercial farms with small scale survey (Casey and Holden, 2005a) and national scale statistics and modelling (GGELS, 2010). CF was found to be correlated with milk per cow, economic allocation factor and on-farm diesel use, but not with other parameters such as concentrate per cow, fertilization rate, electricity use per kg milk (Fig 1).

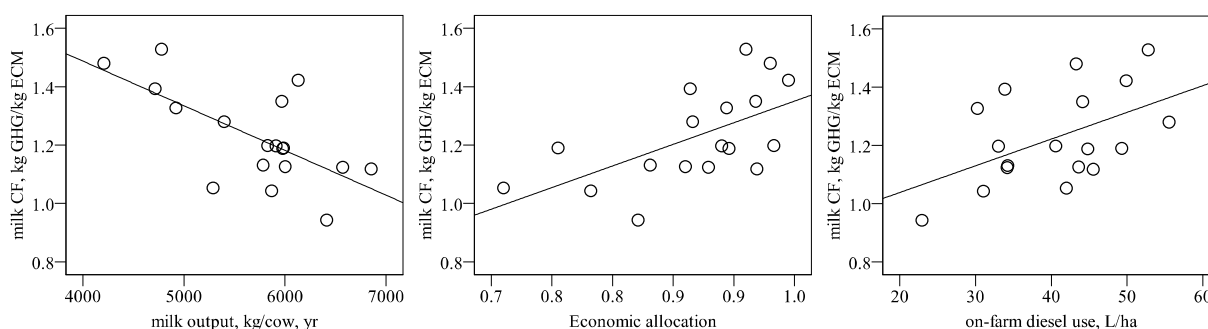

Figure 1. Relationship between milk CF and Left: milk output per cow ($r^2 = 0.43$, $p < 0.001$), middle: economic allocation factor ($r^2 = 0.36$, $p < 0.001$); right: on-farm diesel use ($r^2 = 0.25$, $p < 0.05$).

4. Conclusions

It was concluded that a combination of multiple strategies would determine CF of milk production on commercial dairy farms, and one of the most important indicators was milk output per cow. The effect of the proportionate rule on CF needs to be further analysed.

References

- Casey, J.W. and Holden, N.M., 2005a. Analysis of greenhouse gas emissions from the average Irish milk production system. *Agricultural Systems* 86, 97-114.
- EPA (Environmental Protection Agency), 2010. Ireland's national inventory report for 2010. EPA, Johnstown Castle, Wexford, Ireland.
- GGELS, 2010. Evaluation of the livestock sector's contribution to the EU greenhouse gas emissions. Joint Research Centre, European Commission.
- Statutory Instruments No. 610, 2010. European Communities (Good agricultural practice for protection of waters) regulations 2010. The Statutory Office, Dublin, Ireland

Effect of timing of the first nitrogen fertilizer application on yield of winter wheat in Ireland

Efretuei, A.^a, Gooding M.^a, White E.^b, Hackett R.^c, and Spink J.^c

^aSchool of Agriculture Policy and Development, University of Reading, Reading UK, ^bAFBI Crossnacreevy Plant Testing Station Crossnacreevy, Belfast, UK, ^cTeagasc Crop Research Centre Oak Park Carlow, Co. Carlow, Rep. of Ireland

1. Background & Objectives

To improve the nitrogen use efficiency (NUE) in winter wheat, appropriate fertilizer management practices must be adopted. According to Moll et al. (1982) NUE is the amount of grain produced for each unit of nitrogen (N) available to the crop. Moll et al. (1982) expressed NUE as a product of two components; the nitrogen uptake efficiency which studies how efficiently the plant takes up nitrogen supplied to it, and the nitrogen utilization efficiency which examines how efficiently the plant utilizes or channels the nitrogen taken up for grain production (Moll et al., 1982; Moll et al., 1987). NUE is influenced by the rate and time of application and applying N fertilizers only when required by the plant may improve the nitrogen uptake and utilization efficiency. The objective of this study was to improve the NUE of winter wheat sown in Ireland by estimating the appropriate time for first N application.

2. Materials & Methods

A field experiment was performed at Teagasc Crop Research Centre Oak Park, Carlow, Rep. of Ireland in 2011. In this study all growth stages (GS) were classified using the Zadoks growth scale classification for cereal crops. The experimental design used was a split-plot design with four replications arranged as a randomized complete block design. The main plot factor was slurry treatment (with cattle slurry or without cattle slurry). The split-plot treatments were a factorial arrangement of time of first N application (GS 24, 30, 31, 32, 37 and a zero N control) and seed rates (100 and 400 seeds/m²). N treatments and the different timings applied are listed in Table 1. A total of 200 kg N ha⁻¹, as calcium ammonium nitrate (CAN), was applied to each treatment with 70 kg N/ha applied in the first application and the remainder applied after the crop had reached GS 31 or 15 days after the initial treatment, depending on which occurred the latest.

Table 1. Nitrogen fertilizer treatments and dates of 1st application

1 st split	2 nd split
GS 24 (9 th March 2011)	GS 31
GS 30 (28 th March 2011)	GS 31
GS 31 (11 th April 2011)	GS 33
GS 32 (20 th April 2011)	GS 39
GS 37 (10 th May 2011)	GS 55

Slurry was applied at 22 m³ ha⁻¹ one day before sowing in autumn 2010. Slurry treatments were introduced to determine whether the effect of N timing was influenced by soil and/or crop N amount at the onset of spring growth. Two seed rates were used to create a high and low tillering pattern (Darwinkel, 1978). The size of each split-plot was 24 x 2.15 m. The variety of wheat used was Cordiale. Grain yield was determined using a combine harvester. Subsamples were taken for moisture content determination and yield expressed at 85% dry matter. Results were analysed using the linear mixed model analysis in GENSTAT version 13 (VSN international Ltd). The model included slurry (S), N timing, (NT), seed rate (SR) and the interactions S x NT, S x SR, NT x SR, and S x NT x SR. Treatment means were separated using the Fischer's LSD (p<0.05).

3. Results & Discussion

There were no significant two-way or three-way interactions between N timing, seed rate and slurry treatment. N timing and seed rate treatments had a significant effect on yield ($p < 0.001$) but slurry application had no significant effect on yield. The lack of a slurry effect on yield might have been due to N losses over the winter period. Compared to all other N timing treatments, applying the first application of N at GS 30 gave a significantly higher yield ($p < 0.05$). Grain yields where first N application was at GS 24 or GS 31 were not significantly different. There was a significant reduction in yield where the first N application was delayed until GS 32 compared to applying first N at GS 31 ($p < 0.05$). There was a further significant decrease in yield when first N application was delayed until GS 37 compare to GS 32 ($p < 0.05$). The lowest yield was observed in the control treatment (zero N application). The high seed rate treatment had a significantly higher yield than low seed rate treatment ($p < 0.001$).

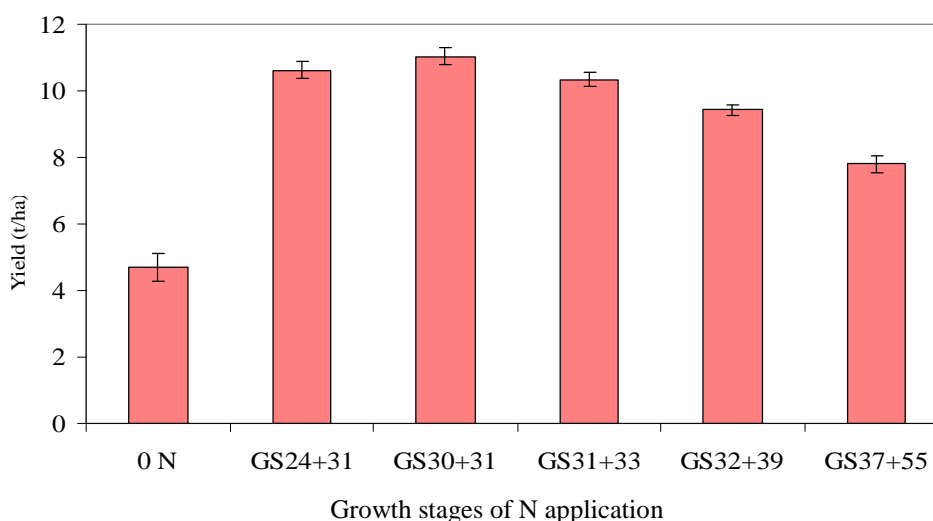

Figure 1. Effect of 1st N application on grain yield showing growth stages for 1st and 2nd split applications respectively and standard error bars. t/ha=tonnes/hectares. Data are averaged over seed rate and slurry treatments.

4. Conclusions

Application of first N fertilizers at GS 30 appears to have a beneficial effect on final grain yield compared to earlier or later timings. Since all treatments received the same amount of fertilizer N, the results indicate that NUE is decreased when the first N application to winter wheat is made earlier or later than GS 30. The results also indicate that the appropriate timing for the first N application to winter wheat is not dependent on plant population density.

Acknowledgements

We acknowledge the Teagasc Walsh Fellowship Scheme for financial support.

References

- Darwinkel, A. 1978. Patterns of tillering and grain production of winter wheat at a wide range of plant densities, *Netherlands Journal of Agricultural Science* 26, 383-398.
- Moll, R.H., Kamprath, E.J. and Jackson, W.A. 1982. Analysis and interpretation of factors which contribute to efficiency of nitrogen utilization, *Agronomy Journal* 74, 562-564.
- Moll, R.H., Kamprath, J.E. and Jackson, W.A. 1987. Development of nitrogen-efficient prolific hybrids of maize, *Crop Science* 27, 181-186.

Effect of Organic and Inorganic Nitrogen fertilizer and Plant Densities on Yield and Quality of Sugar beet

Eman.I.R.E.^a, Mahmoud, E.A.^a, Hassanin, M.A.^a

^aAgronomy Department, Faculty of Agricultural, Cairo university.

1. Background & Objectives

Nitrogen has the greatest influence of all elements on root quality. Sucrose production of sugar beet, grown with inadequate nitrogen, generally has a high sucrose percentage and low impurities, but root and sucrose production was limited (Azzazy., 2004). Too much N increases root impurities and reduces sucrose percentage and consequently limits refined sucrose production. (Beshit et al.,1995; Pruvlovic et al., 2010). The objective of the study was to study the effect of integrated use of mineral and organic nitrogen on growth, yield and quality of sugar beet under two different plant densities. This was undertaken in order to maximize sugar beet yield and quality, minimize the deteriorative effect of high N rates on beet quality and minimize the pollution which resulting from mineral N application.

2. Materials & Methods

Two field experiments were carried out at the Agriculture Experimental Station of the faculty of Agriculture, Cairo University, Giza, Egypt. Experiments were conducted during 2008/2009 and 2009/2010 seasons, using Mont Bianco Variety (imported from Germany). The sowing operation was done on 19th October 2008 and 13th October 2009 and the harvest was 201 days after sowing. A split-plot design with four replicates was used with nitrogen rates (144, 192 and 240 kg N ha⁻¹) arranged randomly in the main plot, Nile compost (16% N) rates (0, 2.4 and 4.8 tons ha⁻¹) in sub plots and plant densities (96 000 and 110 400 plants ha⁻¹) in sub sub plots.

- 1- Sucrose percentage was determined according to Carruthers and Oldfield (1960).
- 2- Sodium, Potassium and Alpha-amino nitrogen percentages in the laboratory Center , faculty of agriculture, Cairo university.
- 3- Recoverable sugar percentage (RS%) (corrected sugar %) was determined by using the following formula according to Reinefeld et al (1974)

$$RS \% = [pol \% - 0.029 - 0.343(Na + K) - 0.094(alpha - a \text{ min } o N)] \quad [1]$$

Where:

$$pol \% : \text{Sucrose, } K, Na \text{ and } a \text{ min } o - N \text{ in } Mq / 100 \text{ gm fresh beet} \quad [2]$$

- 4- Recoverable sugar yield (RSY) ton ha⁻¹.
 $RSY = \text{Root Yield} (ton ha^{-1}) * \text{Recoverable Sugar \% (Corrected Sugar)} \quad [3]$

3. Results & Discussion

Root yield and recoverable sugar yield in tons per hectare, as affected by nitrogen and compost rates and plant density as well as their interactions in 2008/09 and 2009/10 seasons, are illustrated in (Table 1-4). The effect of nitrogen rates on root and recoverable sugar yield were significantly over the two seasons. Least significant difference (L.S.D) at 5 % of nitrogen rate at 144 kg ha⁻¹ was significantly lower than any other nitrogen rate. Nitrogen rate of 240 kg ha⁻¹ was significantly higher than nitrogen rate of 192 kg ha⁻¹ these result was in agreement with (Besheit; Mekki ;El-Sayed.,1995; Azzazy., 2004).

Table 2. Effect of mineral nitrogen on yields of sugar beet in 2008/2009 and 2009/2010 seasons.

N kg/fed	Root yield (ton/fed)		Recoverable sugar yield (ton/fed)	
	1st season	2nd season	1st season	2nd season
60	30.37	31.14	4.66	4.76
80	33.73	33.88	4.89	4.89
100	37.94	37.85	5.44	5.30
L.S.D _{5%}	1.63	2.07	0.28	0.30

Table 2. Effect of mineral nitrogen on yields of sugar beet in 2008/2009 and 2009/2010 seasons.

N kg/fed	Root yield (ton/fed)		Recoverable sugar yield (ton/fed)	
	1 st season	2 nd season	1 st season	2 nd season
60	30.37	31.14	4.66	4.76
80	33.73	33.88	4.89	4.89
100	37.94	37.85	5.44	5.30
L.S.D _{5%}	1.63	2.07	0.28	0.30

The differences in yields induced by changing compost rates were significant in both seasons.

Table 3. Effect of organic nitrogen (compost) on yields of sugar beet in 2008/2009 and 2009/2010 seasons.

Comp. ton/fed	Root yield (ton/fed)		Recoverable sugar yield (ton/fed)	
	1 st season	2 nd season	1 st season	2 nd season
0	31.85	32.04	4.46	4.55
1	33.11	34.31	4.91	4.99
2	37.08	36.52	5.70	5.47
L.S.D _{5%}	1.63	2.07	0.28	0.30

The influence of plant density was significant in both seasons.

Table 4. Effect of plant density on yields of sugar beet in 2008/2009 and 2009/2010 seasons.

Pl.density plant/fed	Root yield (ton/fed)		Recoverable sugar yield (ton/fed)	
	1 st season	2 nd season	1 st season	2 nd season
40 000	32.77	33.33	4.74	4.80
46 000	35.26	35.25	5.28	5.20
L.S.D _{5%}	1.33	1.69	0.23	0.25

All interactions were significant effect on root yield and recoverable sugar yield per hectare.

Conclusion

Application of mineral nitrogen or organic nitrogen (compost) affect positively on growth behaviour of sugar beet that is finally increased root and sugar yields of sugar beet plants.

How does sheep grazing affect the greenhouse gas balance of a grazed steppe ecosystem?

Schönbach, P.^a, Wolf, B.^b, Wiesmeier, M.^c, Dickhöfer, U.^d, Wan, H.^a, Gierus, M.^a, Butterbach-Bahl, K.^b, Susenbeth, A.^d, Taube, F.^a

^a Institute of Crop Science and Plant Breeding (Grass and Forage Science/Organic Agriculture), University of Kiel, Germany, ^b Institute for Meteorology and Climate Research, Karlsruhe Institute of Technology, Kreuzackbahnstrasse 19, 82467 Garmisch-Partenkirchen, Germany, ^c Lehrstuhl für Bodenkunde, Department für Ökologie und Ökosystemmanagement, Wissenschaftszentrum Weihenstephan für Ernährung, Landnutzung und Umwelt, Technische Universität München, 85350, Germany, ^d Institute of Animal Nutrition and Physiology, Christian-Albrechts-University, Hermann-Rodewald-Str. 9, 24118 Kiel, Germany

1. Background & Objectives

Grasslands not only possess a major food resource for livestock farming, but also play a major role in the global fluxes of greenhouse gases (GHG), i.e. CO₂, CH₄, and N₂O, and thus contribute to the increasing radiative forcing of the earth's atmosphere. The present study quantifies GHG emissions in a common sheep farming system in semi-arid native grassland of Inner Mongolia for a range of sites, differing in grazing intensity.

2. Materials & Methods

A partial life-cycle-assessment (LCA) method was used to conduct a whole-farm GHG balance (excluding pre- and post-farm processing steps). GHG fluxes were related to an area-based (ha) and a product-based (kg liveweight gain) functional unit, i.e. GHG balance (GHGB) and GHG intensity (GHGI), respectively. During 2005-2008, we measured carbon sequestration (change in soil organic carbon), CH₄ oxidation (by closed-chamber method), and N₂O production (by closed-chamber method) from grassland in a replicated series (at least two) of experimental sites. Measurements details on CO₂, CH₄ and N₂O are explained in Wolf et al. (2010), Chen et al. (2011) and Wiesmeier et al. (2012). The study was conducted in semi-arid, native grassland within the Xilin River catchment, Inner Mongolia Autonomous Region, P.R. China (43°38' N, 116°42' E). At the field level, GHG fluxes were measured at replicated controlled grazed sites differing in grazing intensity and at ungrazed (UG) successional sites. On average grazing plots were lightly (LG), moderately (MG), and highly (HG) stocked with 0.54±0.09, 1.15±0.02, and 1.91±0.05 sheep ha⁻¹ year⁻¹, respectively. Enteric CH₄ production was estimated on the basis of herbage nutritive value and sheep's digestible organic matter intake. Additionally, further GHG emissions from the manure management and the use of primary energy were quantified. GHGs were finally allocated to main (meat) and by-products (wool, dung) according to the economic option. Management effects on GHG fluxes were analysed by ANOVA using the Mixed Model of SAS (9.1). Multiple comparisons of means were made by Tukey's Test.

3. Results & Discussion

Increasing grazing intensity significantly increased the emission of GHGs (Table 1). While successional UG sites act as significant sinks, grazed sites emitted large amounts of GHGs. GHGB of the HG management system was the strongest source of GHG emissions. Per kg of liveweight gain, GHG intensity (GHGI) was highest and lowest at HG and LG, respectively (Table 1). GHGB was predominantly determined by soil organic carbon changes and field fluxes and, to a lesser extent, by enteric CH₄ production. The manure management and the use of primary energy marginally contributed to the emission of GHGs (Figure 1). Grazing exclusion, as practiced in the UG treatment, led to a significant sequestration of atmospheric CO₂, whereas grazing depleted the soil organic carbon stock, i.e. a significant net emission of CO₂. Therefore, a reduction in grazing intensity has a large potential as a GHG mitigation strategy.

Table 1. GHG fluxes according to different management options.

Treatment	GHGB (kg CO _{2eq} ha ⁻¹ year ⁻¹)	GHGI (kg CO _{2eq} kg ⁻¹ LWG)
UG	-1476±2507b	-
HC	327±1533ab	-
LG	154±1468ab	7.2±68.8a
MG	2350±2784a	53.9±63.9a
HG	3115±3397a	56.1±61.2a

Means ± SD within a column followed by the same letter are not significantly different at *P* < 0.05 (Tukey's test).
 UG, ungrazed; HC, ungrazed with hay cutting; LG, lightly grazed; MG, moderately grazed; HG, heavily grazed.
 GHGB, greenhouse gas balance
 GHGI, greenhouse gas intensity

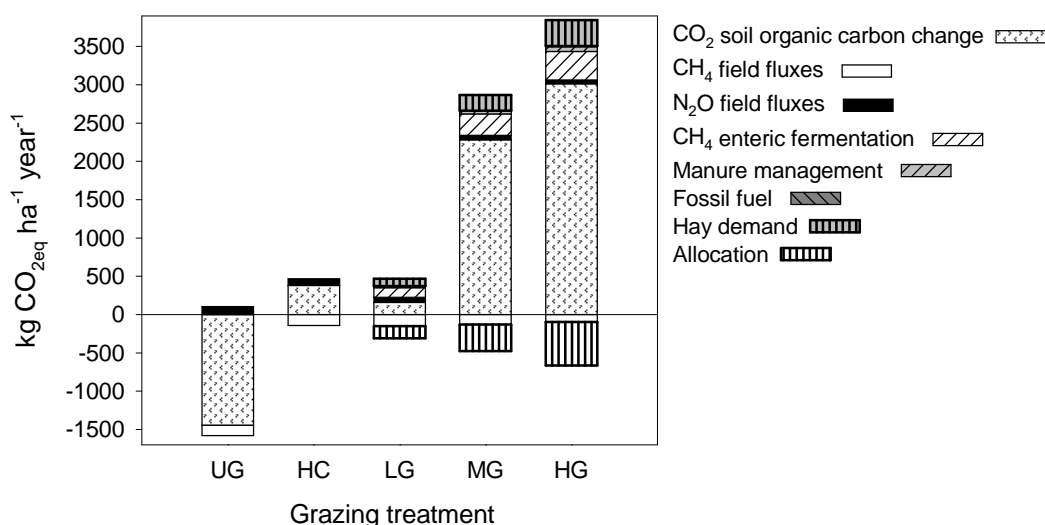

Figure 1. Effect of grazing treatment (UG, ungrazed; HC, ungrazed with hay cutting; LG, lightly grazed; MG, moderately grazed; HG, heavily grazed) on net GHG balances.

4. Conclusion

The grazing-induced depletion of soil organic carbon through increasing grazing intensity and the corresponding emission of CO₂ dominated the GHG balance. Grazing exclusion, as practiced in the UG treatment, has large GHG mitigation potential through CO₂ sequestration. In contrast, grazing results in a significant release of GHGs, mainly due to losses in soil organic carbon.

References

Chen, W., Wolf, B., Zheng, X., Yao, Z., Butterbach-Bahl, K., Bruggemann, N., Liu, C., Han, S. and Han X. 2011. Annual methane uptake by temperate semiarid steppes as regulated by stocking rates, aboveground plant biomass and topsoil air permeability. *Global Change Biol* 17 (9), 2803-2816

Wiesmeier, M., Kreyling, O., Steffens, M., Schönbach, P., Wan, H., Taube, F. and Kögel-Knabner I. 2012. Short-term degradation of semiarid grasslands—results from a controlled grazing experiment in Northern China *J. Plant Nutr. Soil Sci.*, 1-9

Wolf, B, Zheng, X, Brueggemann, N, Chen, W, Dannenmann, M, Han, X, Sutton, M, Wu, H, Yao, Z. and Butterbach-Bahl K 2010. Grazing-induced reduction of natural nitrous oxide release from continental steppe. *Nature* 464 (7290), 881-884

Influence of different nitrogen fertilizers on forage maize yield and quality

García, M.I., Báez, D., Louro, A., Castro, J.

INGACAL-CIAM, Xunta de Galicia, Apdo. de correos 10, 15080 A Coruña, Spain.

1. Background & Objectives

Galicia is the primary milk production region of Spain. The production is associated with a feed management system based on own-grown crops (maize and grass silage) and concentrates. Atlantic European project Green Dairy found that nitrogen surplus was very high with $349 \text{ kg}\cdot\text{ha}^{-1}$ (García et al., 2007). In this context of excessive use of nitrogen on farms there are commercial interests in selling slow-release fertilizers and fertilizers with nitrification inhibitors, with a higher cost than traditional mineral fertilizers. Furthermore, at this time, farmers' economic margins are decreasing due to rising input prices and drop of milk price. The potential benefit of using new fertilizers in forage maize has not been tested in Galicia. The aim of this study was to determine their influence on forage maize yield and quality and to compare with traditional mineral and organic fertilizers.

2. Materials & Methods

The nitrogen fertilizers experiment was carried out in the Agricultural Research Centre of Mabegondo (CIAM) in 2008, 2009 and 2010. They were established in different sites with soils of similar characteristics. Trials using a randomized block design with three replicates were established. Different fertilizers were compared: T1 (0 $\text{kg}\cdot\text{ha}^{-1}$ of N), T2 (Mineral fertilizer 15-15-15+ urea), T3 (Entec 20-10-10 with DMPP), T4 (20-12-8/20-8-6/20-7-9 with DCD), T5 (20-10-5/18-7-5/18-7-5 with DURAMON technology), T6 (D-Coder 14-7-12 /15-8-5/18-5-5), T7 (Urea), T8 (Injected cattle slurry) and T9 (Injected pig slurry) with the same amount of nitrogen ($200 \text{ kg}\cdot\text{ha}^{-1}$) applied before sowing, only T2 was fractionated in $125 \text{ kg}\cdot\text{ha}^{-1}$ before sowing and $75 \text{ kg}\cdot\text{ha}^{-1}$ for the top dressing. Amounts of P and K were levelled between different fertilizers. Forage maize variety DKC3745 was sown in May. Yield and quality were measured at harvest. The data were analyzed using the MSTAT statistical package for analysis of variance.

3. Results & Discussion

In 2008 fresh yield did not show significant differences between treatments, only the control T1 had lower yield than T4 and T7. In 2009 the control treatment T1 had a significantly lower yield than all other treatments and among these T4 highlighted with the highest fresh yield. In 2010 differences were not significant. In 2008, 2009 and 2010 dry matter percentage differed significantly between treatments. Slurry treatments had the highest values due to a shorter growing season (Table 1).

Table 1. Fresh and dry yield ($\text{kg}\cdot\text{ha}^{-1}$) of forage maize for the three-year experiment.

	Fresh yield ($\text{kg}\cdot\text{ha}^{-1}$)			Dry matter (%)			Dry yield ($\text{kg}\cdot\text{ha}^{-1}$)		
	2008	2009	2010	2008	2009	2010	2008	2009	2010
T1	43133 b	46220 c	49218	35.49 ab	29.52 b	34.09 a	15200 b	13660 c	16786
T2	46265 ab	65998 b	45856	34.60 ab	30.72 ab	32.63 ab	15916 ab	20246 b	14956
T3	48850 ab	68005 b	43379	35.29 ab	31.75 ab	32.10 ab	17149 ab	21531 b	13987
T4	53954 a	78382 a	48903	33.45 b	30.48 ab	32.17 ab	17904 a	23840 a	15766
T5	50820 ab	69657 b	47291	33.79 b	30.04 ab	31.79 ab	17156 ab	20950 b	15040
T6	47587 ab	68402 b	43357	33.80 b	31.53 ab	32.09 ab	15998 ab	21545 b	13925
T7	54720 a	64029 b	44266	33.21 b	30.70 ab	31.54 b	18080 a	19573 b	13960
T8	49500 ab	62574 b	52015	36.74 a	33.04 a	33.35 ab	18120 a	20631 b	17375
T9	-	65320 b	46399	-	32.15 ab	33.52 ab	-	20995 b	15589
SIGN.	**	**	NS	*	*	*	**	**	NS

Table 2. Crude protein content (CP) and in vitro organic matter digestibility (IVOMD) of forage maize for the three-year experiment.

	CP (% on DM)			IVOMD (% on OM)		
	2008	2009	2010	2008	2009	2010
T1	5.45 b	3.98 c	5.37	75.54	71.91	75.56
T2	6.66 a	5.85 a	5.87	76.65	71.99	76.50
T3	6.49 a	4.91 b	6.09	75.89	72.32	76.39
T4	6.57 a	5.81 a	5.83	75.35	72.10	76.21
T5	6.45 a	5.79 a	5.91	75.39	71.93	76.53
T6	6.64 a	5.94 a	5.93	76.16	72.33	76.58
T7	6.56 a	5.12 ab	5.93	75.37	71.56	76.50
T8	6.09 a	4.89 b	5.98	76.97	72.57	75.80
T9	-	5.24 ab	6.07	-	72.03	76.81
SIGN.	**	**	NS	NS	NS	NS

Means within the same column which bear different letters are significantly different at $P < 0.01$ (**) and $P < 0.05$ (*) using Student-Neuman-Keul multiple range test.

In 2008 the greatest dry yields were obtained for treatments T4, T8 and T7 although only significant differences were found with the control T1. In slurry treatments this value was due to a higher dry matter percentage. In 2009 treatment T4 had a significantly higher yield and the control T1 had a significantly lower yield than all other treatments. In 2010 dry yield did not show significant differences between treatments, but treatment T8 highlighted with the best yield (Table 1).

In agreement with other studies, fertilizers with DMPP and DCD did not have significant differences in maize yield (Carrasco and Villar, 2001; Báez et al., 2004; Díez-López et al., 2008), although some authors found maize yield increases using nitrification inhibitors but only in some soils and climatic conditions (Nelson and Huber, 1992; Pasda et al., 2001). In relation to the nutritional value (Table 2), the control T1 was significantly lower in crude protein in the first two years. In 2009 treatments T2, T4, T5 and T6 highlighted. Other authors found no significant differences in protein with DMPP (Pasda et al., 2001) and DCD (Buerkert et al., 1995). In vitro organic matter digestibility did not show significant differences between treatments.

4. Conclusion

Traditional mineral and organic fertilizers showed, in Galicia soil and climate conditions, similar behaviour in yield and nutritional value to slow-release fertilizers and fertilizers with nitrification inhibitors as indicated Ruitjer (2009): when fertilizers are applied according to good practice it is questionable whether slow release fertilizers and fertilizers with DMPP perform better.

References

- Báez, D., Coutinho, J. and Trindade, H. 2004. Efecto del sistema de laboreo, tipo de abonado y uso de inhibidores de la nitrificación en la producción de maíz forrajero. XLIV Congreso de la SEEP, 541-545.
- Carrasco, I. and Villar, J.M. 2001. Field evaluation of DMPP as a nitrification inhibitor in the area irrigated by the Canal d'Urgell (Northeast Spain), In: W.J. Horst et al. (eds.), Plant nutrition-food security and sustainability of agroecosystems, Kluwer Academic Publisher, Holland, 756-757.
- Díez-López, J.A., Hernaiz, P., Arauzo, M. and Carrasco, I. 2008. Effect of a nitrification inhibitor (DMPP) on nitrate leaching and maize yield during two growing seasons. Spanish Journal of Agricultural Research 6(2), 294-303.
- Nelson, D.W., Huber, D. 1992. Nitrification inhibitors for corn production. Iowa State University, U. Extension, pp. 6.
- García, M.I., Castro, J., Novoa, R., Báez, D. and López, J. 2007. Improving nitrogen mineral balance and conversion rate in dairy farms in Galicia (Spain). XV Nitrogen Workshop, Lérida (Spain), 401-403.
- Pasda, G., Hähndel, R. and Zerulla, W. 1997. Effect of fertilizers with the new nitrification inhibitor DMPP on yield and quality of agricultural and horticultural crops. Biology and Fertility of Soils 34, 85-97.
- Ruijter, F.J., 2009. Fertilizers in field vegetables. XVI Nitrogen Workshop, 249-250.

Nitrate metabolism in leaves of lettuce plants grown in floating system with different nitrate concentrations

Podetta, N., Ferrante, A.,

Dept. Plant Production, Università degli Studi di Milano, Italy

1. Background & Objectives

The nitrate content in leaves of vegetables represents an important quality parameter. Epidemiological studies showed a positive correlation between nitrate intake and gastrointestinal cancer incidence in humans. Since nitrates are constitutively present in drinking water and largely used as meat preservatives, the EU imposed thresholds for the commercialization of leafy vegetables. EU countries apply this regulation differently and to a limited number of species. In Italy the nitrate content limits have only been imposed for lettuce, spinach and rocket. Many factors influence the nitrate accumulation in leaves. In practice, fertilization plays an important role, even if each species may have a different behaviour. In floating systems, the plant roots are directly in the nutrient solution and nitrate concentration may influence the assimilation pathway and plant performance. The aim of this work was to investigate if different nitrate concentrations affected the nitrate accumulation in lettuce baby leaf.

2. Materials & Methods

Lettuce [*Lactuca sativa* L. var. *acephala* type *Batavia*] cv. *Rubia flavia*] plants were grown in floating system under natural conditions in a greenhouse equipped with an environmental parameters control station. Plants were grown in three nutrition solutions containing 2, 10 or 20 mM N-NO₃ while other macroelements expressed in mM were: 2.8 P, 8.4 K, 3.5 Ca, 1.4 Mg and Hoagland's concentration for micronutrients. Nitrate content was measured by spectrophotometer using the salicylic-sulphuric acid method with slight modifications (Cataldo et al., 1975). Nitrate reductase activity *in vivo* was determined using leaf discs, about 0.3 g each sample. The assay buffer contained 100 mM phosphate buffer pH 7.5, 30 mM KNO₃ and 5% (v/v) propanol. The leaf discs were placed in the assay buffer and were incubated at 30 °C for 15 min. in a water-bath and then boiled. Blank samples were immediately boiled and incubated. In all reactions, the nitrite content was measured using equal volume of color development reagent (1% sulfanilamide in 3N HCl and 0.02% N-(1-naphthyl)-ethylenediaminehydrochloride). The reaction mixtures were incubated at room temperature for 15 min and absorbance was read at 540 nm. The amount of nitrite was calculated by a calibration curve obtained with standard solutions containing 0, 25, 50, 100 and 120 nmol KNO₂. Sucrose and reducing sugars have been extracted and determined as reported in Trivellini et al. (2011). Data were subjected to ANOVA analysis and differences among means were determined with Bonferroni's post-test.

3. Results & Discussion

The yield of lettuce grown in the different nutrient solutions were not affected by nitrate concentrations and ranged from 1931 to 2680 g m⁻² (Table 1). The leaf nitrates content was not statistically different among the treatments. The lowest nitrate content was 1412 and the highest 2643

mg kg⁻¹ FW. The nitrate reductase activity *in vivo* determined 11:30 A.M. in the three nitrate concentrations showed that the lowest value was found at 10 mM and the highest was found at 20 mM. The nitrite content decreased by increasing the nitrate concentration in the nutrient solution. The higher amount of nitrite was found at 2 mM, while at 10 or 20 mM the nitrite were 14.39 and 8.62 ng g⁻¹ FW, respectively (Table 1). The sucrose content increased with nitrate concentration in the nutrient solution (Figure 1A). An analogous trend was observed for reducing sugars, as plants grown in higher nitrate concentrations had similar reducing sugars content (Figure 1B).

Table 1. Yield, nitrates, nitrate reductase activity and nitrites in lettuce plants grown in floating system with 2, 10 or 20 mM nitrate in the nutrient solution. Values are means with standard errors (n=4).

Parameters	Nitrate concentration in the nutrient solution		
	2 mM	10 mM	20 mM
Yield (g m ⁻²)	2258.7±127.15	2296.5±59.16	2438.0±129.72
Nitrates (mg kg ⁻¹ FW)	2201.489±210.57	1839.5±153.41	2094.5±210.01
NR activity (μg NO ₂ g ⁻¹ h ⁻¹)	86.03±4.565ab	58.18±8.504b	110.16±1,700a
Nitrites (ng NO ₂ g ⁻¹)	902.03±450.91a	14.39±8.45b	8.62±4.05b

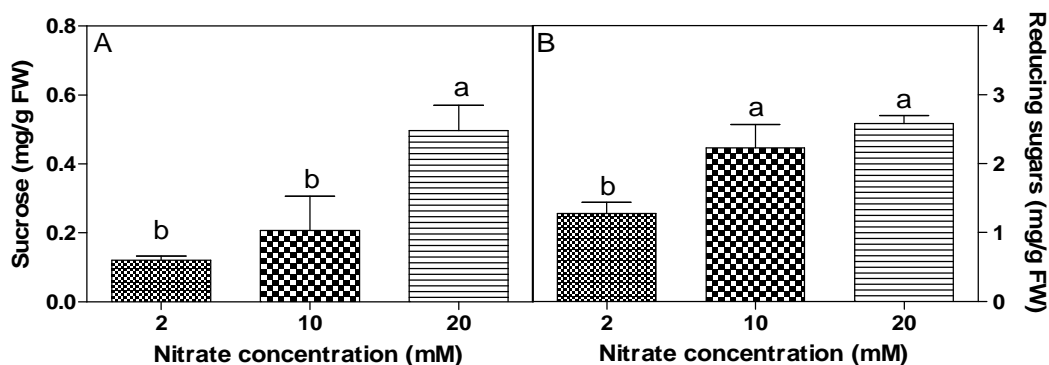

Figure 1. A) Sucrose content and B) reducing sugars in leaves of lettuce baby leaf grown in floating system with different nitrate concentration in the nutrient solution. Data reported are means with standard errors (n=4). Different letters indicate statistical differences for P<0.05. Different letters indicate statistical difference for P<0.05.

4. Conclusions

Lettuce baby leaf can grow with nitrate concentrations as low as 2 mM without affecting yield and nitrate accumulation in leaves. Since, the nitrite content was higher in plants grown in the 2 mM nutrient solution compared with 10 or 20 mM, for cultivation purpose a nutrient solution containing 10 mM can be suggested.

References

- Trivellini, A., Ferrante, A., Vernieri, P. and Serra, G. 2011. Effects of promoters and inhibitors of ABA and ethylene on flower senescence of *Hibiscus rosa-sinensis* L.", J Plant Growth Regul. 30, 175-184.
- Cataldo, D.A., Haroon, M., Sevrader, L.E. and Youngs, V.L. 1975. Rapid colorimetric determination of nitrate in plant tissue by titration of salicylic acid, Commun Soil Sci. Plant. Anal. 6, 71-80.

Reducing Nitrogen in a High-Input Chinese Double-Cropping System – Effects on Yield, Soil Nitrogen and Mineralisation

Hartmann, T.^a, Schulz, R.^a, Müller, T.^a, Chen, X.P.^b, Zhang, F.S.^b

^aPlant Nutrition and Soil Matter Dynamics, Department of Crop Science, Universität Hohenheim, Stuttgart, Germany

^bCollege of Resources and Environmental Sciences, China Agricultural University, Beijing, PR China

1. Background & Objectives

The People's Republic of China (PRC) faces two major issues, which may or may not be antagonistic to one another. On the one hand, the Government must ensure food security for an ever growing population; on the other hand, it must find a way to reduce environmental pollution, a large portion of which is caused by agricultural production systems. In the North China Plain, the PRC's most important area for the cultivation of wheat and maize, the use of synthetic nitrogen fertilisers has continuously increased, while grain yields have remained stagnant or decreased for the last twenty years (China Agricultural Yearbook, 2008). In a winter-wheat / summer-maize double cropping system, up to 600 kg of nitrogen are fertilised per year per hectare, resulting in a continuous excess of nitrogen accumulating in the soil profile, which leads to nitrate leaching (Subbarao, 2006), and the emission of climate relevant trace gases (Yan, 2003). The described experiment evaluated alternatives to the current fertilisation system, with the aim of reducing nitrogen input while retaining current yield levels of a winter-wheat / summer-maize double cropping system, thereby reducing N surpluses, and subsequently the risk of nitrogen losses.

2. Materials & Methods

In a field experiment carried out from May 2009 to October 2011 in Quzhou, Hebei Province, PRC, 8 nitrogen treatments were compared in a winter-wheat / summer-maize double cropping system, in order to observe effects on yield and mineral nitrogen contents in the soil. Chosen treatments of this experiment are the two control treatments C (Control): 0 N; FP (Farmers' practice, urea): 550 kg N ha⁻¹ a⁻¹, R (Reduced, urea) and ASN+NI (Reduced, ammonium sulphate nitrate + nitrification inhibitor DMPP). The reduced treatments were fertilised according to nitrogen demands of the crop and taking mineral nitrogen in the soil (N_{min}, 0-90 cm depth) into account. The fertilisation rates of the reduced treatments were determined individually.

Apparent Nitrogen Use Efficiency (NUE) of the fertilised treatments was determined using the following formula:

$$\text{NUE (\%)} = \left(\text{N}_{\text{treatment}} \text{ (kg ha}^{-1}\text{)} - \text{N}_{\text{control}} \text{ (kg ha}^{-1}\text{)} \right) / \text{N}_{\text{fertilised}} \text{ (kg ha}^{-1}\text{)} * 100$$

The content of mineral nitrogen in the soil profile was determined throughout the experimental period, in order to observe possible reductions of mineral nitrogen over time.

3. Results & Discussion

The experiment showed that nitrogen fertilisation in a Chinese wheat / maize double cropping system can be reduced by up to 50% compared to farmers practice (FP), without significantly affecting the yield of either maize or wheat. A significant reduction in yield could only be observed in the zero nitrogen control treatment (C) of wheat in both years, and in the third year of maize cultivation (data not included).

N_{\min} concentrations in the soil profile (0 – 200 cm) of the zero control treatment decreased in the first year (C), while the reduced nitrogen treatment (R) showed a stable or slightly reduced N_{\min} content, and nitrogen continued to accumulate in the profile of the FP treatment.

Table 1. Fertilised nitrogen (kg ha^{-1}), grain yield (Mg ha^{-1}) and $\text{NUE}_{\text{GRAIN}}$ (%) of the treatments C, FP, R, and ASN+NI in the first and second season of the experiment. Letters indicate significant differences (Tukey-HSD, $\alpha = 0.05$)

		1 st Season			2 nd Season		
	Treatment	Applied N	Yield	NUE	Applied N	Yield	NUE
Maize	C	30	5.7 ^A	-	30	5.9 ^A	-
	FP	250	6.4 ^A	8.6	250	6.0 ^A	9.6
	R	190	6.6 ^A	12.9	105	7.2 ^A	40.9
	ASN+NI	190	6.9 ^A	15.3	105	6.7 ^A	30.0
Wheat	C	0	1.8 ^a	-	0	3.0 ^a	-
	FP	300	4.7 ^b	25.4	300	6.7 ^b	26.4
	R	90	4.4 ^b	54.9	170	6.0 ^b	41.1
	ASN+NI	100	5.6 ^b	81.8	160	5.8 ^b	61.1

Despite low N_{\min} concentrations in the soil of treatment C, the zero control treatment showed no significant reduction of yield compared to fertilised treatments in the first two harvests of maize, which indicates that, taking the deposition of atmospheric nitrogen into account (approx. $80 \text{ kg N ha}^{-1} \text{ a}^{-1}$), there must be a strong mineralisation of organic nitrogen or release of adsorbed ammonium in the soil during the summer vegetation period, which is characterised by both high temperatures and precipitation.

4. Conclusion

A reduction of fertilisation rates drastically reduced the amount of nitrogen in the system, while ensuring a retention of the current yield levels in this experiment. Reducing the amount of nitrogen in a system is the first step towards reducing the loss of nitrogen through emissions and leaching. Further research should determine total nitrogen fractions in soils, including exchangeable and fixed nitrogen in order to understand nitrogen dynamics in overloaded agricultural systems.

References

- China Agricultural Yearbook (2008), China Agriculture Press
 Yan Xiaoyuan. 2003. Estimation of nitrous oxide, nitric oxide, and ammonia emissions from croplands in East, Southeast and South Asia, *Global Change Biology* 9, 7
 Subbarao., G.V. 2006. Scope and strategies for regulation of nitrification in agricultural systems – challenges and opportunities, *Critical Reviews in Plant Sciences* 24, 4

Soilless cultivation of vegetables in The Netherlands to reduce nitrogen emissions

de Haan, J.J.^a, van Os, E.A.^b, Blind, M.P.^c, Verhoeven, J.T.W.^a

^aApplied Plant Research Wageningen UR, P.O. Box 430, 8200 AK Lelystad, The Netherlands

^bPlant Research International Wageningen UR, P.O. Box 16, 6700 AA Wageningen, The Netherlands

^cProeftuin Zwaagdijk, Tolweg 13, 1681 ND Zwaagdijk-Oost, The Netherlands

1. Background & Objectives

Many vegetable crops in open field production in The Netherlands do not meet the requirements of the European Union (EU) Water Framework Directive and EU Nitrates Directive mainly because of high nitrate emissions. In addition, these cropping systems have difficulty in complying with new market requirements, such as pesticide residues and constant quality and delivery. Within the current cropping systems, there are few options available to reduce these emissions without affecting the crop productivity and crop quality (de Haan et al., 2010, de Haan et al., 2009). The objective of this paper is to describe the development of soilless, recirculating profitable cropping systems for leafy vegetables and cabbages to reduce nitrogen emissions and to comply with other demands.

2. Materials & Methods

A structured method was used to design and develop new cropping systems derived from other methods used in the design of open field production systems (de Haan and Garcia Diaz, 2002; Vereijken, 1997), protected cultivation systems (van Henten et al., 2006) and animal husbandry systems (Groot Koerkamp and Bos, 2008). The systems focussed on iceberg lettuce (*Lactuca sativa* var. *capitata*), lollo rosso (*Lactuca Sativa* var. *acephala*), leek (*Allium porrum*) and cauliflower (*Brassica oleracea* convar. *botrytis* var. *botrytis*). First, an analysis was made of the current cropping systems of leafy vegetables and cabbages taking into account technical as well as environmental, societal and legal aspects. Secondly, a summary of requirements was established for all crops and various systems were designed, engineered and tested in the first year on a small scale on experimental farms. The systems which fulfilled the requirements were selected for further development. This process was repeated once more to select the most promising system for a crop. This final system was further optimized e.g. fertilization, variety use and growing media and laid out on a larger scale, preferably with a commercial grower. The sustainability and profitability of the selected systems were assessed in detail on all sustainability aspects (Planet, People, Profit): Planet aspects considered nutrient and pesticide emissions, energy use, climate change, land use, water, biodiversity and waste; People aspects considered labour and food quality and Profit aspects considered profitability, financial risks and competitiveness.

3. Results & Discussion

Results showed that all crops could be grown on various chosen soilless systems. For all vegetable crops, recirculating deep flow systems are increasing and show potential to fulfil the set requirements. Main advantages of deep flow systems are minimal use of substrate, robustness because of a large buffer due to the water volume as well as good fertilization and temperature control.

Production per hectare per year was much higher compared to field production. For instance, leek production was much higher on deep flow systems with 200-300 ton leek ha⁻¹ year⁻¹ in four cropping periods with much higher planting densities (70-80 plants m⁻²), compared to field

production with 30-50 ton ha⁻¹ in one cropping period with planting density of about 16-20 plants m⁻².

Crop production was much steadier compared to field production with a constant growth rate irrespective of dry or wet periods, less loss of plants, cleaner products without soil or organic contamination and less damage and loss of quality due to pests and diseases. In addition, there are no problems with accessibility of land in wet periods during planting, harvesting or crop treatments. Recirculation of water on an experimental scale gave no problems with pests and diseases. In leafy vegetables, water was reused during two growing seasons without any adverse effect on crop production. However, there will be discharge of water from the systems because of accumulation of salts or precipitation deficits as the systems are not covered. Current investigations are underway to study the best way of minimizing nutrient emissions to surface- and groundwater from these systems and to conduct sustainability assessments. Implementation of the systems has already started as some leading vegetable growers have started their own experiments.

4. Conclusion

Soilless cultivation of open field vegetables is technically feasible and expected to be profitable. It gives new possibilities for farmers to grow better products for new market sectors with higher yields. Soilless cultivation has the potential to reduce nitrate emissions drastically. However, how much reduction is possible with these recirculation systems is still under investigation.

References

- de Haan, J.J., Zwart, K.B., Smit A.B. and van Geel W.C.A. 2009. Can intensive arable farming systems on sandy soils in the Netherlands meet the targets in the nitrate directive? Proceedings 16th Nitrogen Workshop, Connecting different scales of nitrogen use in agriculture, Turin, Italy, 28 June – 1 July 2009, 471-472.
- de Haan, J.J., Sukkel, W. and Stilma, E.S.C. 2010. Technology versus Agro-Ecology in Designing Vegetable Production Systems in the Netherlands. *Acta Horticulturae* 852, 123 - 130.
- de Haan J.J. and Garcia Diaz, A. (eds.) 2002. Manual on Prototyping Methodology and Multifunctional Crop Rotation. VEGINECO Report 2. Applied Plant Research. Lelystad. The Netherlands.
- Groot Koerkamp, P.W.G. and Bos, A.P. 2008. Designing complex and sustainable Agricultural production systems: an integrated and reflexive approach for the case of table egg production in the Netherlands. *NJAS* 55, 113-138.
- van Henten, E.J., Bakker, J.C., Marcelis, L.F.M., van 't Ooster, A., Dekker, E., Stanghellini, C., Vanthoor, B., Randraat B.V. and Westra, J. 2006. The Adaptive Greenhouse - an Integrated Systems Approach to Developing Protected Cultivation Systems. *ISHS Actae Horticulturae Proc. IIIrd* 718, 399-406.
- Vereijken, P. 1997. A methodical way of prototyping integrated and ecological arable farming systems (I/EAFS) in interaction with pilot farms. *European Journal of Agronomy* 7, 235-250.

The influence of locally injected nitrogen fertilizer (CULTAN) on seed yield of winter rape and grain yield of spring barley in the Czech Republic

Peklová, L., Sedlář, O., Balík, J., Kozlovský, O., Kubešová, K.

Department of Agro-Environmental Chemistry and Plant Nutrition, Faculty of Agrobiological Sciences, Food and Natural Resources, Czech University of Life Sciences Prague, Prague, Czech Republic

1. Background & Objectives

The CULTAN method (Controlled Uptake Long Term Ammonium Nutrition), enables the required nitrogen in the vegetation period to be applied in one application (Sommer, 2005). This method is based on the injection of the ammonium form of fertilizer to a soil depth of 6 – 10 cm, where it is retained at the point of application (Boelcke, 2000). The ammonium ion is retained by clays and organic matter in these localised areas and the toxicity of the ammonium-N inhibits nitrification and nitrogen movement away from the plant root system. Nitrogen uptake by plants is controlled by the phytotoxicity of ammonia (Sommer, 2005). The objectives of this trial was to evaluate the influence of the method CULTAN on seed yield of winter rape and grain yield of spring barley.

2. Materials & Methods

A 3-year small-plot trial commenced in 2008 at three different experimental sites in the Czech Republic (central Europe), to determine the effect of the CULTAN method on yield of winter rape (*Brassica napus* L.) cultivar Artus and on yield of spring barley (*Hordeum vulgare* L.) cultivar Jersey. In the conventional (control) treatment the total dose of nitrogen fertilizer was divided into the component applications. In the CULTAN treatment the whole N application was applied at once with a injection machine (Maschinen und Antriebstechnik GmbH Güstrow, Germany). The total amount of nitrogen applied was 200 kg N ha⁻¹ for winter oilseed rape and for spring barley it was 80 kg N ha⁻¹. The CULTAN fertilization was applied at stage of growth BBCH 26 (branching) in the experiment with winter rape and at stage of growth BBCH 29-30 (offsetting) in the experiment with spring barley. To evaluate the yields, one-factor ANOVA was used followed with the Scheffé's test at the P < 0.05 level of significance. The computations were done using the Statistica 9.0 programme (StatSoft, Tulsa, USA).

3. Results & Discussion

The three-year experiment with winter rape and spring barley showed no significant effect of the CULTAN method on seed yield of winter rape or grain yield of spring barley compared to the conventional treatment (Figure 1). CULTAN fertilization resulted in a lower density of spring barley cover compared to the conventional fertilization system (Sedlář et al., 2011a). Plants of winter rape were shorter and plant development was more compact (Sommer, 2005). A lower height of winter rape plants was observed after fertilizing using the CULTAN method compared to the conventional treatment (Peklová et al., 2011a) and CULTAN treated plants tended to have less disease, which is in agreement with the findings of Felgentreu (2003). CULTAN treatment did not lead to higher dry matter content in aboveground biomass (Peklová et al., 2011b) which is contrary to the findings of Sommer (2005). Higher thousand grain weight observed in CULTAN treated spring barley plants (Sedlář et al., 2009) can be explained by the lower intensity of tillering (Petr et al., 1988; Sommer, 2005; Longnecker et al., 1993) and by a longer period of assimilate storage to ears compared to conventional nitrogen fertilization (Sommer, 2005). Higher weights of thousand seeds in winter rape plants were observed when the CULTAN method was used, particularly at the more fertile experimental site, i.e. at Hnevceves site. Locally injected nitrogen fertilizer resulted in higher resistance of spring barley to lodging (Sedlář et al., 2011b). The grain yield of the CULTAN treated spring barley plants were statistically higher at the less fertile site at higher altitude and wetter climate (Humpolec), compared to the more fertile site (Ivanovice). Winter rape

was a very N demanding crop and according to our findings CULTAN fertilization was more suitable at the fertile site (Hnevceves).

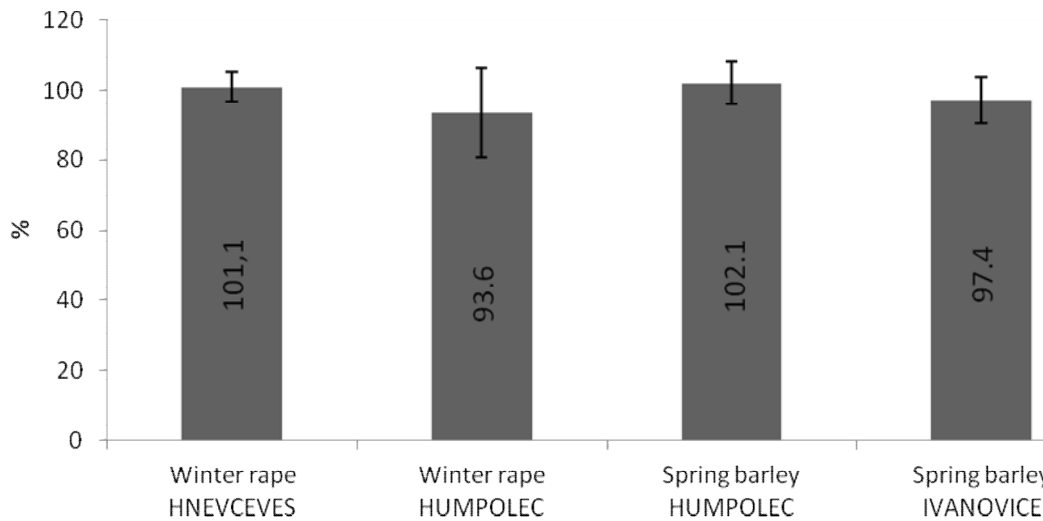

Figure 1. Yields of CULTAN treatments expressed as a percentage of conventional treatments (conventional treatment presents 100 %) for average seed yield of winter rape and grain yield of spring barley at different sites in the experimental years 2008-2010.

4. Conclusion

The method CULTAN is the comparable alternative to conventional way of nitrogen fertilization in the Czech Republic. When growing spring barley the use of this method tends to increase weight of thousand grain and also reduce cover lodging. For winter rape on more fertile soils, CULTAN is capable of getting comparable yields to conventional fertilizing, and improves both economical and environmental effects.

Acknowledgement

This work was supported by grant MSM 6046070901, NAZV QH 91081 and CIGA 20112033.

References

- Boelcke, B. 2000. Application of the liquid fertilizer near to the roots. The first experience with the nitrogen fertilizer injection (Depot or CULTAN fertilization), *Deutsche Landwirtschaft Zeitschrift* 11, 26-30.
- Felgentreu, C. 2003. Erste Ergebnisse beim Einsatz des Injektiondüngerverfahren bei Winterraps in Brandenburg, In: *Landbauforschung Völkenrode, Anbauverfahren mit N-Injektion (CULTAN) Ergebnisse, Perspektiven, Erfahrungen, Sonderheft 245*, 55-60.
- Longnecker, N., Kirby, E.J.M. and Robson, A. 1993. Leaf emergence, tiller growth and apical development of nitrogen-deficient spring wheat, *Crop Science* 1, 154-160.
- Peklová, L., Kozlovský, O., Sedlář, O. and Kos, M. 2011a. Plant dry matter production and the nitrogen content in straw and in the seed of winter rape after fertilization by the method CULTAN, In: „The rational use of fertilizers“, *Proceedings of 17th International Conference, Praha*, 122-26.
- Peklová, L., Balík, J., Kozlovský, O., Sedlář, O. and Kubešová, K. 2011b. The yield and quality of winter oilseed rape in the system of nitrogen fertilizer injection (CULTAN), In: *Soil, Plant and Food Interactions, Proceedings of International Conference, Praha*, 344-349.
- Petr, J., Černý, V. and Hruška, L. 1988. *Yield Formation in the Main Field Crops*, Elsevier, New York pp 336.
- Sedlář, O., Kozlovský, O., Černý, J., Kos, M. and Balík, J. 2009. Yield formation of spring barley grain in the experiment using the CULTAN system, *Reasonable Use of Fertilizers, Proceedings of conference, Praha*, 129-132.
- Sedlář, O., Balík, J., Kozlovský, O., Peklová, L. and Kubešová, K. 2011a. Impact of nitrogen fertilizer injection on grain yield and yield formation of spring barley (*Hordeum vulgare* L.), *Plant, Soil and Environment* 12, 547-552.
- Sedlář, O., Kozlovský, O., Peklová, L. and Kubešová, K. 2011b. Effect of nitrogen injection application on growth progress of spring barley, *Agrochémia* 2, 11-14.
- Sommer, K. 2005. *CULTAN-Düngung*, Verlag Th. Mann, Gelsenkirchen pp 218.

4 SESSION

Knowledge Transfer

Oral Presentations

Effective stakeholder communication: together we stand, divided we fall!

Aarts, H.F.M.^a, Humphreys, J.^b, Le Gall, A.^c

^aWageningen-UR (Plant Research International), Wageningen, Netherlands

^bTeagasc, Moorepark, Fermoy, Co. Cork, Ireland

^cInstitut de l'Élevage, Paris, France

1. Introduction

Research has helped to understand and thereby to improve the functioning of agricultural systems, which are important for human welfare. Further improvements are needed and thought to be possible. The cost-effectiveness of research can be improved by a better understanding of the knowledge requirements of the relevant stakeholders and by a more effective communication of research results. In this paper we tried to analyse the relationships between scientists and stakeholders and to make suggestions about how to increase the effectiveness of their communication. We concluded that we should be better aware of the unique values of verbal conversation as part of the communication system.

2. Interrelationship scientist-stakeholder

For a scientist a stakeholder is someone that provides resources to do research (inputs) or that absorbs research results (outputs). Mostly resource providers are the same people or are strongly connected to the people that consume the fruits of scientific work. Such resource providers need research products to improve the effectiveness of their activities and researchers need resources to continue conducting research. While in the short term it can be profitable for a provider to cut investments in research, in the longer term it can be damaging to further business development. For a scientist it can be interesting in the short term to neglect the needs of the resource provider that creates opportunities in order to please another stakeholder, for instance by preparing a paper for a scientific journal or by contributing to a workshop. However, when a scientist neglects the needs of the resource provider for too long or too often the provider will stop providing resources. So researchers and their stakeholders depend on each other. If one goes down, the other will go down also, perhaps after a short period of increased happiness. Effective cooperation is essential for sustainable functioning of both. However, certain elements of the behaviour of researchers and stakeholders can threaten this cooperation.

3. Species of scientists and stakeholders

There are different categories of researchers. Roughly they can be divided in 3 species, depending on their habitat: 1) universities or public research institutes for basic research, 2) applied research organizations and 3) research departments of commercial companies. There are also different types of stakeholders: 1) farmers and farming industry, 2) government departments and agencies and 3) scientific journals. They all have their specific needs, culture and thereby behaviour. Farmers and farming industry like to implement knowledge and innovations to optimize their businesses. In general this leads to a better utilization of resources, including land and labour. Also governments want to optimize farming practices and farming industry as it leads to higher employment, gains through direct and indirect taxes due to increased productivity, resulting in better welfare of the general voting public. Furthermore, governments want to sustain or improve the quality of environment by legislation. Appropriate knowledge is needed to ensure that appropriate legislation is put in place. Such knowledge can include, for instance, the level of acceptable nutrient losses or the cost-effectiveness of measures to prevent pollution. Farmers, farming industries and

governments supply money and sometimes also research facilities, like experimental farms, or means of dissemination and communication such as newspapers, magazines or websites.

Scientific journals are quite different from the other stakeholders. They are interested in originalities in science, mostly not in their applicability in systems of agricultural production. They provide possibilities to scientist to increase their scientific status (citation index), which helps in the acquisition of new funding opportunities from funding agencies. Scientific journals don't supply resources for research. They only supply possibilities to spread research results with the scientific society as the target group.

4. Knowledge requirements of stakeholders

For academic or basic researchers the number of published refereed publications is an important indicator for success. For scientific journals originality of contributions is essential but it becomes more and more difficult to check the originality of offered papers, mostly describing very detailed research. There is no database to control. Mostly 2 or 3 reviewers are asked by the editor to give their opinion about originality and quality. The editor has to base his judgment to publish or not on their advice. It is more and more difficult to find qualified experts to review adequately. Usually, they are not paid by the journal, so the cost of their time spent reviewing has to be paid by other funders or by themselves. Consequently chance can often play an important role in acceptance of an offered manuscript. Communication between editors, reviewers and contributing scientists is only by internet applications and standardised by strict formats. Verbal conversation is excluded. With this 'efficient' communication system there is a high risk that 'old' knowledge will be published as 'new' without being recognized as such.

Governments require knowledge, mainly for legislation purposes and to help farmers and farming industry to solve problems and to stay competitive. A problem is that people working for the government nowadays often don't have an education in agricultural or environmental sciences. Often they studied economics, politics or communication. Besides they usually change jobs every 3 or 4 years. Communication with scientists is often by calls for research and (in return) by reports. Face to face communication is infrequently and not very effective, because of differences in culture, interests and background knowledge. Besides, mostly there is a rather long period between the call for information by the government, and the delivery of information by scientists. In that period the political and economic situation may have changed considerably. For example, due to the economic crises Ireland has recently rediscovered the importance of agriculture for the national economy due to its impact on exports and national balance of payments. Utilization of the knowledge delivered by scientists can also be poor because political or policy (not scientific) arguments play an important role. These uncertainties in the use of outputs by governments, or absence of feedback, stimulate scientists to focus on scientific journals. Besides the number of published scientific papers and citation-indexes are important parameters in the selection of project proposals submitted in response to the tendering process for such projects by government. This stimulates the scientist to regard the scientific paper as the most important objective of his work.

Scientists working in applied research organizations and in research departments of commercial companies have the shared experience that there is intensive personal communication between researcher and the user of research results, for instance farmer advisory services, farmers unions and farmers cooperatives. They are production orientated and talk more and write less. People employed by these organization mostly stay within the organisation for their entire working lives, are very

skilled and highly motivated. Applied research scientists are familiar with culture and knowledge needs of their stakeholders and are often strongly involved in implementing new knowledge, for instance via presentations to farmers or via on-farm demonstrations such as pilot farms. Often the activities of the stakeholder and scientist overlap. In general discovering how existing knowledge can contribute to the development of a farming system is more relevant than making use of recent scientific publications. For these scientists it is difficult to publish in scientific journals, because mostly reviewers will conclude 'nothing new' from a synthesis of existing knowledge and its testing at farm scale. Their outputs are reports, articles in farmers magazines and oral presentations for an audience of stakeholders. A good example of the impact of applied research on the profitability of agriculture is the reduction of the use of purchased mineral nitrogen in the past decade in the dairy regions of Europe. Stimulated by the Nitrate Directive and the rising costs of fertiliser N relative to the farm-gate price received for milk, national governments and farmers had to increase the effectiveness of fertilisation. As a result of applied research recommendations on fertilization were revised with better integration of the use of organic manures, better accounting of N mineralised from soil organic matter, better distribution of fertilisers during the growing season, closer matching of fertilisation to expected grassland utilisation (grazing or cutting) and N-fixation by clovers. Programs were developed to implement improvements on farms. Experimental farms and pilot commercial farms played an important role in knowledge transfer by demonstrating new ways of working and providing opportunities to farmers to gain trust by discussion with other (pilot) farmers, farm advisors and scientists. As a result the mineral fertilizer N use on farms declined with no significant loss of yield. In Ireland the decline was about 30%, in the Netherlands about 50%, which has had an enormous effect on farm profitability. On a Dutch dairy farm annual savings are about €7,500. Traditionally, this production orientated job is typically executed by people with family roots in agriculture. The number of scientists with such a background is declining. Besides, it needs a number of rather 'non-productive' years to learn to do this integrating job appropriately. Nowadays, mostly scientists have to be productive immediately; there is no time allowed to gain experience. In that case it is much more attractive to focus on detailed research with a scientific paper as output. This is in contrast with the increased need of whole system research because farming is more and more complex and multifunctional (production of food, quality of environment, animal welfare). Besides, farmers are overwhelmed with sometimes contrasting information and need reliable and unbiased sources of information to make their decisions.

5. Increasing the cost-effectiveness of research by better communication

We should make a distinction between research that is aimed solely at increasing knowledge and that which aims at application. The most problematic aspects of the first, with the scientific journal as main stakeholder, are to avoid duplication, to guarantee quality and to exclude fraud. Therefore more attention has to be spent on the quality of review. It should be a paid part of the job of excellent scientists and include oral communication between the authors and reviewers in the review process.

Effectiveness of research to be used by government can be increased by a more intensive communication between government employees and scientists to achieve a better focus on the required knowledge and more effective knowledge implementation. On both sides people should be trained for this job. Part of the training should be to learn about the culture (including vocabulary), activities and topics of the organisation. By workshops and other meetings cooperation can grow and become fruitful. For support in implementing regulations the French government orders its

research organisations to write a thematic ‘Expertise Scientifique Collective’. Recently the study ‘Les flux d’azote liés aux élevages’ was finished, describing all aspects of N in livestock farming, including influences on environment. Relevant information and knowledge was brought together by a team of about 25 national and international experts and was integrated, reported and finally discussed with people from government and farmers unions. It provides a basis for formulating the 5th Action Plan as implementation of the Nitrate Directive and for optimisation of livestock farming. ‘Expertise Scientifique Collective’ has proven to be a very effective way of utilising knowledge and in identifying knowledge gaps and therefore this communication method is recommended to other governments.

For supplying farmers with adequate information we need production oriented scientists that are familiar with the farming system, including culture of farmers. These scientists are more or less the intermediaries between more specialized scientist and farmers and their advisors. We have to identify persons that have the ability to do that job, give them the time and opportunities to be a successful communicator and make clear to scientific society that success should not only be estimated by the numbers of produced papers or the citation index. Success should also be measured in terms of impact of the agricultural industry. Experimental and pilot farms play an important role in knowledge transfer, because they act as a platform where communication between science and farming practice is most effective. Since 2003 national networks of experimental farms and pilot farms were very successful brought into an European network in the INTERREG projects Green Dairy (2003-2007) and DAIRYMAN (2009-2013). These projects include visits of farmers, farm advisors and applied scientists to their colleagues in other countries, exchange of tools already regionally in use by farmers, cooperation in testing of innovations emerging from research and meetings with people from government and other stakeholders of the rural area to discuss developments. Such networks are also very useful for education and training. Therefore such a European network of experimental farms, pilot farms and agriculture related organisations (research and advisory institutes, industry, government, schools) should be made permanent.

6. Conclusions

The functioning of agricultural systems has to be improved in a way that food production per unit area increases, because we expect that world population will grow while agricultural area declines. Besides, the limited availability of energy, water and fertilizers requests a more efficient utilisation of these resources. So more knowledge is needed at a time when research budgets are being cut in most countries because of the economic crisis. As a consequence research output needs to be more effective, which means more exploitable output per unit of investment. This requires all stakeholders working more effectively together; and the starting point is improved communication. In the course of time verbal conversation has been replaced by paper-based or electronic communication. Nowadays, most scientists don’t have personal contact with their stakeholders, and therefore they are not very familiar with their needs and capabilities of research output usage, what limits the effectiveness of their work. To improve effectiveness verbal conversation should be reintroduced in the communication process.

Extension and knowledge transfer; effective partnerships for timely impact

Ketterings, Q^a and Czymmek, K^b

^aNutrient Management Spear Program and PRODAIRY,

^bDepartment of Animal Science, Cornell University, Ithaca NY 14853

Abstract

In recent years, the term “adaptive management” has become integrated in government programs in the United States (US). Adaptive management is described as “a process of developing improved management practices for efficient production and resource conservation by use of participatory learning through continuous systematic assessment”, by the NEERA1002 Coordinating Committee on Adaptive Nutrient Management. Such developments reflect recognition by government agencies of the need for (1) effective extension and knowledge development and transfer; (2) a partnership-based process for timely and true impact at the farm, watershed and state levels; and (3) continuous improvement in managing agricultural systems to enhance environmental protection while remaining profitable. Various models existed for such knowledge development and transfer in the past, some effective, others less successful. In this presentation we will show the approach that led to a sharp reduction in statewide phosphorus balances for New York State and its dairy farms, and discuss extension and knowledge transfer models and partnerships that have been shown to be most effective. The central question in the presentation is: how can we bridge the gap between ever-more-detailed and narrow research and the knowledge requirements and implementation capabilities of our stakeholders?

1. Background & Objectives

Similar to experiences of Irish and other European farmers, farmers in the United States have gone through a period of unprecedented volatility in milk, meat, and crop prices as well as input costs such as fertilizer and concentrates. With these developments came the desire to better manage limited resources, reduce cost of production, and stabilize or increase output. Examples in New York State have shown that such fine-tuning of management is both possible and profitable. For example, Table Rock Farm, a dairy farm in western New York State was able to reduce its whole farm nutrient balance of nitrogen (N), phosphorus (P) and potassium (K) by more than 50% (Figure 1) while milk production increased to 12835 kg milk per cow in 2010, 13% higher than the average milk production at the farm in 2005! What gave this farm the confidence to adopt narrow row corn practices, inject manure, plant cover crops, reduce fertilizer use, adopt zone tillage, and increase the percent homegrown forage in its dairy rations? Is this farm one of just a few farms that made such improvements? Or are there more farms? What can we learn from this farm’s story and can the approach be expanded to enable more farms to reduce their environmental footprint, stabilize production, and be profitable in light of volatile milk, meat and crop prices and input costs?

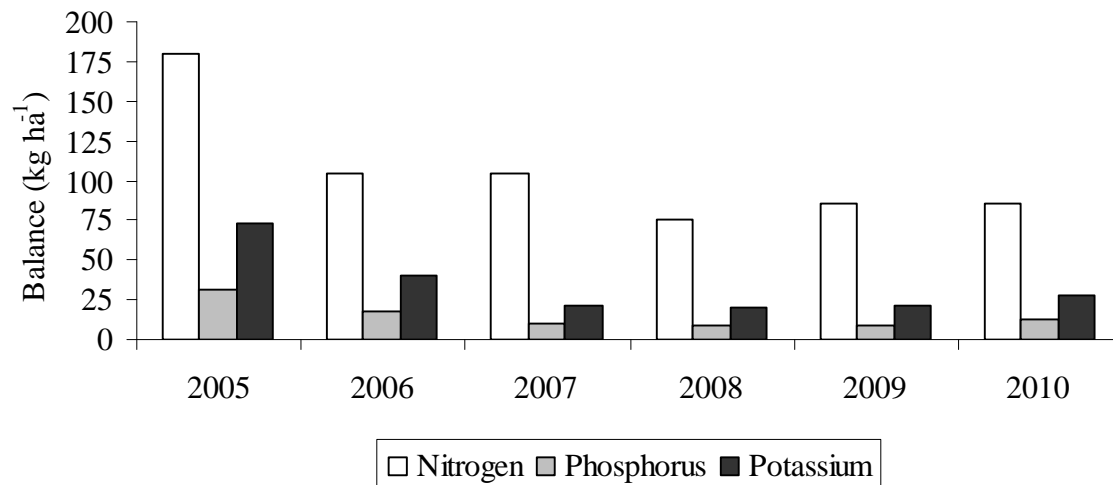

Figure 1. Whole farm nitrogen, phosphorus and potassium balances of Table Rock Farm in western New York State decreased by more than 50% within 3-4 years while milk production per cow went up.

2. Results -Table Rock Farm Case Study

In 2006, the crop management crew of Table Rock Farm, managing 850 milking cows in Castile, NY, approached Cornell University's Nutrient Management Spear Program (NMSP; <http://nmssp.cals.cornell.edu>) with a request for help with setting up on-farm research. The dairy farm was questioning its use of starter N fertilizer and wanted to evaluate if additional N was needed beyond their regular practices at the time to plant corn (*Zea mays* L.) with 34 kg N ha⁻¹ and to use manure to meet the rest of the N needs of the crop. At that time, their whole farm N balance was high, 180 kg N ha⁻¹ excess N (Figure 1), and the farm was interested to learn how to cut production costs as well. The farm implemented fully replicated strip trials, comparing a no-starter control versus 34 and 67 kg N ha⁻¹. These trials were continued for two years and in three different fields. The results of the studies showed corn could be planted with manure only (Table 2), saving the farm US\$37 per ha in fertilizer costs alone, a total saving of about US\$10k across the farm's approximately 265 ha of corn, in addition to a saving of almost 9000 kg of N across the farm.

Table 1. On-farm strip trials showed corn could be planted without starter N fertilizer.

Starter N use	2006	2007	2007	Average
kg N ha ⁻¹	2 nd year corn	1 st year corn	4 th year corn	
	----- Corn silage yield (Mg ha ⁻¹ ; 100% DM) -----			
0	8.36 a	8.64 a	5.72 a	7.57 a
34	8.23 a	8.68 a	6.01 a	7.64 a
67	8.26 a	8.80 a	5.78 a	7.62 a
Average	8.28	8.71	5.84	7.61

In years after these studies, the farm continued to evaluate its practices, confirming that manure injection was the right way to go after two years of comparisons of different application methods, and that 84 kL ha⁻¹ of liquid manure was the target rate based on trials in 2010 and 2011. In addition to measuring yield, the farm evaluated silage quality, and environmental indicators such as soil testing and corn stalk nitrate tests were included to evaluate possible tradeoffs between yield and environmental protection (Ketterings et al., 2012). And, while whole farm balances were drastically reduced, milk production increased to 12835 kg milk per cow in 2010, from 11329 kg milk per cow in 2005 (Figure 1).

The farm manager, Willard DeGolyer, explained why he found it important to work with the university on trials on his farm:

- (1) Why do you participate in on-farm research projects?
>knowledge >profit >interest for employees and owners, interaction with college
- (2) Have on-farm crop research plots been helpful to your operation? How?
Yes, reduced fertilizer inputs, reduced fuel use, >yields, again, employee interest in results
- (3) What are some key ingredients for a successful project?
The project should give measured answers to the questions and decisions made on farm.
- (4) How much do plot harvests slow down your field crew?
There is a little slow down at harvest - 60 acres chopped on study day rather than 75
- (5) Replicated studies sound complicated and seem like overkill-what do you say?
Good answers with low standard deviations justify replicated study

Lessons learned through working in this farm partnership illustrated some key principles:

- Involve farm in topic selection, trial implementation, and data collection.
- Keep the research targeted and simple but scientifically sound:
 - 3-4 treatments at a maximum.
 - 4 replications at a minimum.
 - Annual reports to farmer and meeting to discuss results – make plan for next year.

Farmer, Consultant and University Partnerships

Although the example of Table Rock Farm is an illustration of a very effective (and intensive) extension and knowledge transfer model and a partnership that is a solid foundation for progress in future years, the approach initially impacted one farm only. Although farms do learn from each other even if they do not participate in such projects, the main expansion of the work at Table Rock Farm came through the development of preliminary data that allowed the university extension team and its farmer and farm advisor on-farm research partnership to successfully apply for additional funding and to expand the trials beyond Table Rock Farm. To date, 21 starter N trials have been completed (Ketterings et al., 2012b) while nine other farms have participated in manure application method comparisons in past years (Place et al., 2005). Other examples included a statewide project on starter P fertilizer that resulted in completion of 71 trials (Ketterings et al., 2005) and a sharp reduction in P

fertilizer use in New York State (Ketterings et al., 2011; 2012a), further illustrating the effectiveness of such on-farm research partnerships. In a recent survey among certified nutrient management planners in New York State, the confidence gained due to such on-farm research was identified as a major driver in reductions in farm and state P balances (Ketterings and Czymmek, in review). Statewide projects like this are essential for improvement of Land Grant University fertility and environmental management guidelines, enabling farmers and their advisors to learn alongside researchers and be partners in development of guidance for all farms.

Stick or Carrot Approach?

New York State's P story is a good example of the need for both a stick and carrot approach. In 2003, the state implemented the New York State Phosphorus Index (PI; Czymmek et al., 2003) as a tool for manure and fertilizer P management. This PI was developed based on federal regulatory pressure beginning in the late 1990's. Starting in 2003, a PI assessment for each field became mandatory for all regulated farms. The introduction of the PI, the on-farm research partnership that led to completion of the 71 starter P trials, and P related extension programming were all conducted simultaneously. Recent interviews of certified nutrient management planners in New York State related to P use on farms and the PI as a tool for management evaluation revealed two key ingredients for this successful on-the-ground impact (Ketterings and Czymmek, 2012):

- “The history of collaboration and trust between the public, academic, and private sector stakeholders in New York State has led to a track record of efficient problem solving. Involve stakeholders in the process and hold them accountable to create real solution.”
- “The New York phosphorus index has been the most effective planning tool for evaluating the risks associated with applying manure to cropland. The Institution of the CAFO regulatory program was the main driver for changes in nutrient management and soil conservation, however.”

This feedback identified the importance of (1) ownership among those impacted by policy changes, research findings etc. for adoption of alternative practices, and (2) accountability that leaves the farms with greater confidence and options for management. The starting point for such impact was knowing the initial baseline data and the point of view of the receiver of information. For a successful knowledge transfer program, the actual message is not as important as the partnership and understanding farmer reality that leads to asking the right questions and an adaptive management process that leads to answers and on the ground impact.

Key Lessons Based on New York Experiences

Keys to farm level impact:

- Understanding of the concerns and recognition that change is necessary among all.
- Identification of win-win situations first.
- Use of technology where possible.
- Ask relevant questions, generate believable results, collect reliable data (replicated trials).
- Farmer involvement and accountability in the process (on-farm research, farmers as drivers of the adaptive management process).

- Development and maintenance of a trust-based farmer, advisor, researcher relationship.

For state level impact, key ingredients are:

- Recognition that change is necessary among all involved.
- Application of common sense to influence sound decision-making (farmers, regulators).
- Implementation of change via policy, incentives, measuring and monitoring; hold people accountable but allow for flexibility.

3. Conclusions

For the sustainability of agriculture anywhere, it is important to find ways to reduce the cost of production, increase yields and/or outputs, and enhance profitability while minimizing environmental loss of nutrients. The examples of New York State discussed in this presentation illustrate key ingredients for success: (1) statewide awareness of the issues driven by regulations and extension programming; (2) science-based tools that allow for farm-specific responses to the environmental challenges (not one approach fits all); (3) demonstrated risk (relevant questions and credible answers obtained through an on-farm research partnership); (4) accountability for all players; (5) enforcement of regulations; and (6) existence of economically feasible solutions. The case study farms recognized the potential for improvement, and explored alternative management through on-farm research and technology use, while looking for win-win approaches (such as reduced fertilizer use). Future models for effective, impact oriented extension and knowledge transfer should start from the viewpoint of the farmer and hold farmers, their advisors and the research community accountable for finding solution, as a partnership.

References

- Czymmek, K.J., Q.M. Ketterings, L.D. Geohring, and G.L. Albrecht. 2003. The New York Phosphorus Index. User's guide and documentation. CSS Extension Bulletin E03-13. 64 pp.
- Ketterings, Q.M. and K.J. Czymmek. 2012. P Index as a P awareness tool: Documented P use reduction in New York State. *Journal of Environmental Quality* (in review).
- Ketterings, Q.M., K.J. Czymmek, and S.N. Swink 2011. Evaluation methods for a combined research and extension program used to address starter phosphorus fertilizer use for corn in New York. *Canadian J. of Soil Science* 91(3), 467-477.
- Ketterings, Q.M., S.N. Swink, G. Godwin, K.J. Czymmek, and G.L. Albrecht. 2005. Maize silage yield and quality response to starter phosphorus fertilizer in high phosphorus soils in New York. *Journal of Food, Agriculture and Environment* 3, 360-365.
- Ketterings, Q.M., G. Godwin, W. DeGolyer, and K. J. Czymmek. 2012a. Trial results for manure injection at Table Rock Farm. *What's Cropping Up?* 22(2), 17-22.
- Ketterings, Q.M., G. Godwin, S.N. Swink, J. Foster, E. Hong, K.J. Czymmek, C. Albers, P. Barney, B. Boerman, S. Canner, P. Cerosaletti, A. Gabriel, M. Hunter, T. Kilcer, J. Lawrence, E. Young, and A. Wright. 2012b. Can manure replace the need for starter nitrogen fertilizer? 3-year summary. *What's Cropping Up?* 22(1), 8-12.
- Place, A., Q.M. Ketterings, G. Godwin, P. Barney, J. Lawrence, B. Aldrich, T. Kilcer, K.J. Czymmek, and B. Gloy. 2010. Shallow incorporation of manure minimizes soil disturbance and conserves nitrogen. *What's Cropping Up?* 20(3), 3-5.

A framework for designing and evaluating nitrogen-efficient farming systems at the catchment scale by combining process studies, integrated modelling and participatory approach.

Durand P^a, Ruiz L^a, Vertès F^a, Delaby L^c, Moreau P^a, Hubert-Moy L^d, Gascuel-Oudou C^a

^a INRA, UMR1069 Sol Agro et hydrosystème Spatialisation, F-35000 Rennes, France

^b ULCO, UPRES EA 4029 Laboratoire d'Informatique du Littoral, F-62228 Calais, France

^c INRA, UMR1080 Production du Lait, F-35590 St-Gilles, France

^d Université Rennes 2, UMR 6554 COSTEL

1. Background & Objectives

In some closed bays, the maximum nitrogen concentration, in the tributary streams, required to control the impacts of eutrophication coastal water, is very low compared to the concentrations currently observed where intensive agriculture is the dominant land use (e.g. Billen, 2011). Consequently, such territories must reduce drastically their emissions, which often implies redesigning the production systems. This may involve acute socio-economical issues. The objective of this contribution is to present the rationale and some results of a four-year study (ACASSYA project ANR-08-STRA-01, <http://www.inra.fr/acassya>) aiming at developing a comprehensive body of knowledge and tools able to facilitate such evolution. The main challenge was to combine in a coherent and interactive way three different approaches: i) process studies, aiming at quantifying the response time and buffering capacity of the biophysical system, ii) integrated modelling approaches designed to simulate and assess complex and coherent innovative scenarios of farming system changes and iii) a participatory approach, based on a multi-disciplinary diagnostic, involving the design and implementation of systemic changes in selected farms.

2. Materials & Methods

The ACASSYA project consists in three interactive workpackages:

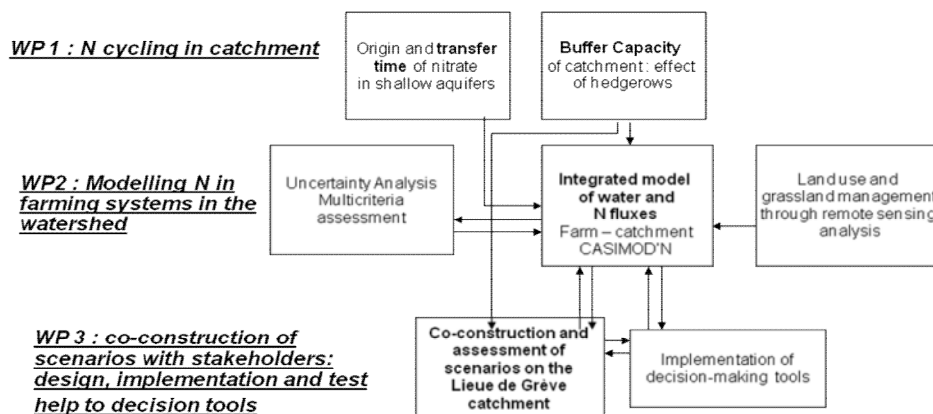

Most of the WP1 work was conducted in long term experimental sites ORE Agrhys (http://www.inra.fr/ore_agrhys) and ZA Armorique (<http://osur.univ-rennes1.fr/zoneatelier-armorique/>) and combined field observations of water and N species dynamics (including isotopes) with modelling. Both WP2 and WP3 were performed in a 120 km² catchment (Lieue de Grève, Brittany, W France) strongly affected by green tides since the early 70s, which are controlled by the nitrate fluxes from the rivers feeding the bays (Menesguen and Piriou, 1995). The nitrate stream concentrations are currently around 7 mg.L⁻¹ and a 60% reduction should be required to hope a significant reduction of the frequency and intensity of algal blooms. The catchment comprises 190

farms (85% cattle farms), and the agricultural area (71% of total area) is occupied for nearly half by grasslands, followed by maize and wheat.

3. Results & Discussion

The main original results concerning N dynamics in shallow aquifer are detailed in Gascuel et al (this meeting), and the CASIMOD'N model is presented by Moreau et al. (this meeting). Farm systems diagnosis and first ways to re-design production systems were presented in Moreau et al. (2012).

In this presentation, we will illustrate the value of this type of integrated project by focusing on a few examples highlighting the added value of the interactions between the different tasks:

- the experimental studies on the effect of hedgerows on water and N fluxes in the hillslope led to the implementation of a specific module into the TNT2 model. Results showed that hedgerow spatial distribution affect water and N fluxes at the catchment scale and provided hints to design more effective hedgerow networks .(tasks 1 feeding task 2 and then task 3)
- remote sensing approaches combined with local expertise brought new ways to characterise pasture at different scales: at the catchment scale, identification of the ley-crop rotations; at the plot scale, information on grassland management and grass status. These data were used to calibrate and validate the CASIMOD'N model (task 3 feeding task 2).
- the participative construction of scenarios of evolution of farming systems led to propose two key-indicators that were tested with CASIMOD'N. The iteration between simulation results and participatory research with stakeholder is now tested in 10 pilot farms, before its implementation in the whole Lieue de Grève catchment. (task 3 feeding task 2 and feedback)

We will use these examples to discuss the following questions: How does modelling facilitate collaboration with stakeholders? How the feasibility of changes can be assessed both i) in the pilot farms and ii) in the whole territory? Is prospective modelling able to predict whether the problem will be solved or not?

4. Conclusion

Trans-disciplinary approach is required to address such a complex issue at the landscape level. This site and the tools developed in this program could be used as a generic framework to support programmes of mitigation of agricultural pollution. .

References

- Billen, G. Nitrogen flows from European regional watersheds to coastal marine waters. In: Sutton MA, Howard CM, Erisman JW, Billen G, Bleeker A, Grennfelt P, et al., editors. The European Nitrogen Assessment. Sources, Effects and Policy Perspectives. Cambridge University Press, 2011, pp. 48 p.
- Gascuel C. et al. (this meeting) The complexity of the recharge processes and their effect on the seasonal variations of nitrate concentration in shallow groundwater and streams: observations and modeling
- Moreau, P., et al. 2012 Reconciling technical, economic and environmental efficiency of farming systems in vulnerable areas. *Agric. Ecosyst. Environ.* (in press), <http://dx.doi.org/10.1016/j.agee.2011.06.005>
- Moreau, P. et al (this meeting) Evaluating innovative farming systems to limit nitrogen diffuse pollution in catchments: development and application of the CASIMOD'N model
- Menesguen, A., and Piriou, J.Y., 1995. Nitrogen loadings and macroalgal (*Ulva* Sp) mass accumulation in Brittany (France). *Ophelia* 42, 227–237.

Estimating the effect of mitigation methods on multiple environmental pollutants

Newell Price, J.P.^a, Harris, D.^b, Chadwick, D.R.^c, Misselbrook, T.H.^c, Anthony, S.G.^d, Gooday, R.D.^d, Taylor, M.^a, Williams, J.R.^b and Chambers, B.J.^a

^aADAS Gleadthorpe, Meden Vale, Mansfield, Notts. NG20 9PF, UK

^bADAS Boxworth, Battlegate Road, Boxworth, Cambridge, CB3 8NN, UK

^cRothamsted Research North Wyke, Okehampton, Devon, EX20 2SB, UK

^dADAS Wolverhampton, Woodthorne, Wergs Road, Wolverhampton, WV6 8TQ, UK

1. Background & Objectives

Under the European Union (EU) Water Framework Directive, the National Emission Ceilings Directive (NECD) and EU Climate Change agreements, the UK government is committed to improving water quality and reducing emissions of ammonia and greenhouse gases (GHGs). These Directives present a number of challenging goals that should be considered in an integrated way to identify best options and avoid ‘pollution swapping’ (i.e. reduction in the loss of one pollutant leading to an increase in another) wherever possible. Hence, succinct information was needed on the effectiveness of a range of mitigation options for diffuse water and air pollutants and GHGs. This paper presents the approach taken in the “*Mitigation Methods - User Guide*” to estimate the effectiveness of a selection of methods in reducing losses of water and airborne pollutants, including nitrate, ammonium and nitrite–nitrogen; particulate and soluble phosphorus, sediment, biochemical oxygen demand, faecal indicator organisms, ammonia, nitrous oxide, methane and carbon dioxide.

2. Materials & Methods

In all, 346 individual methods were considered for inclusion from a variety of publications sourced from the UK and Europe (Newell Price et al., 2011). The 83 selected methods were split into seven categories: “land use”, “soil management”, “crop and livestock breeding”, “fertiliser management”, “livestock management”, “manure management” and “infrastructure”.

2.1 Farm typologies

Farm typologies were established that represented ‘typical farms’ and ‘baseline losses’. These were then used as a framework for estimating cost and effectiveness at the farm scale. The farm typologies were based on the “Robust Farm Types” used in the Defra Business Survey, with crop areas and livestock numbers estimated from the proportions of the land area occupied by each crop type and the stocking densities of each livestock type in the Defra June Agricultural Census (Defra, 2005). The British Survey of Fertiliser Practice (for 2004) was used to provide information on fertiliser types, application rates and timings (Goodlass and Welch, 2005).

2.2 Baseline losses

For each of the farm typologies, pollutant baseline losses were calculated for two soil types (‘permeable’ and ‘impermeable’) and six climate zones based on annual average rainfall values (1961 to 1990). Baseline losses were apportioned into source type (fertiliser, excreta, soil and manure), source area (arable, grassland, rough grazing and steading) and delivery pathway (e.g. surface runoff, piston flow and drainflow for waterborne pollutants). Total baseline losses and their apportionment (into sources and pathways) were estimated using a combination of field experimental data, modelling and expert elucidation, as described by Chadwick et al. (2006).

2.3 Effectiveness of methods

For each mitigation method, effectiveness classes and direction of change assessments were produced for each pollutant. The effectiveness of a method was assigned to a range of values

(Table 1), based on available research data or, where data did not exist, the expert judgement of the project team. Effectiveness was expressed as a percentage reduction relative to the baseline pollutant loss; the effectiveness classes reflect natural variation in their efficiency and variation according to the magnitude of the baseline loss, as well as uncertainty.

Table 1: Method effectiveness classes, ranges and arrow strengths

Description	Average	Range	Arrow strength ^a
None	0	0	~
Low	10	1 to 30	↓
Moderate	40	20 to 80	↓↓
High	70	50 to 90	↓↓↓

^a Arrow directions may also be upwards where a method increases the loss of a pollutant (i.e. pollution swapping occurs).

3. Results & Discussion

The '*Mitigation Methods - User Guide*' estimates indicate that the overall effectiveness of the majority of methods for most pollutants was low, i.e. 1-30%. On the whole, only methods that involved a change in land use, such as 'convert arable land to unfertilised and ungrazed grass', had a moderate to high effect (20 to 90%) across a wide range of pollutants. Some soil management methods, such as 'establish cover crops in the autumn' had a moderate (20-80%) effect on nitrate leaching losses. Organic manures are probably the main cause of controllable nutrient pollution (in present day farming systems) and methods that target manures had a moderate effect on a wide range of pollutants. For example, increasing the capacity of farm slurry (manure) stores to improve the timing of slurry applications had a low-moderate effect on nitrogen (up to 20% reduction in leaching losses) and soluble phosphorus losses. Also, changing from a slurry to a solid manure handling system had a moderate effect in reducing ammonia and nitrate leaching losses, although overall nitrous oxide emissions could potentially be increased due to higher emissions during farmyard manure storage. Methods that target ammonia losses, such as 'washing down dairy cow collecting yards' had a low-moderate effect in reducing ammonia losses at the farm scale. However, the additional nitrogen that is retained in the manure during housing, storage and at land spreading is potentially at risk of loss as the manure moves from housing to store to field. It is therefore important to take account of the increased N content (due to reduced ammonia emissions) at each step in order to reduce subsequent ammonia emission and nitrate leaching loss risks.

4. Conclusions

Most methods, when applied in isolation, had a low-moderate effect in minimising pollutant losses. Good nutrient management gave rise to 'win-win-wins' for water quality, air quality and business profitability, but there was also potential for 'pollution swapping' to occur.

5. References

- Chadwick, D.R., Chambers, B.J., Anthony, S.G., Granger, S., Haygarth, P.M., Harris, D. and Smith, K.A. 2006. A measure-centric approach to diffuse pollution modelling and cost-curve analysis of mitigation measures. Proceedings of the SAC and SEPA Biennial Conference, Edinburgh, 5th-6th April 2006, 93-99.
- Defra (2005). Agriculture in the United Kingdom - 2004. The Stationery Office.
- Goodlass, G. and Welch, W. 2005. British Survey of Fertiliser Practice: Fertiliser use on farm crops for crop year 2004. Defra/SEERAD. ISBN 1 86190 128 3.
- Newell Price, J.P., Harris, D., Chadwick, D.R., Misselbrook, T.H., Taylor, M., Williams, J.R., Anthony, S.G., Duethmann, D., Gooday, R.D., Lord, E.I. Chambers, B.J. 2011. Mitigation Methods – User Guide. An inventory of mitigation methods and guide to their effects on diffuse water pollution, greenhouse gas emissions and ammonia emissions from agriculture. Prepared as part of Defra project WQ0106, 158pp.

Achieving good water quality status in intensive animal production areas: a LIFE+ project

Bortolazzo, E.^a, Ligabue, M.^a, Pacchioli, M.T.^a, Mantovi, P.^b

^a Research Centre on Animal Production – CRPA, Reggio Emilia, Italy

^b CRPA Foundation Studies and Researches, Reggio Emilia, Italy

1. Background & Objectives

“Achieving good water quality status in intensive animal production areas” is the title of a LIFE+ project with the acronym AQUA. The general objective of the project is to contribute to the reduction of water pollution from nutrients at river basin scale by optimising the utilisation of nitrogen and phosphorus in livestock farms, thus reducing nutrients losses to water. This project involves five regions in Northern Italy: Piedmont, Lombardy, Emilia-Romagna, Veneto and Friuli Venezia Giulia.

A review of the draft River Basin Management Plans (dRBMP), which was published in September 2009, showed evidence that the European agricultural sector generates a significant pressure on both quality and quantity of surface and ground waters. Results show, for instance, that diffuse or point source pollution by nitrogen is reported in 91% of the dRBMPs, phosphorus in 90% of the cases and pesticides in 69% of the dRBMPs (Ecologic, 2010).

The amount of nitrogen from animal husbandry spread annually on agricultural soils in the EU 27 is estimated in a recent report from the Commission on implementation of the Nitrate Directive (EC, 2011). It has decreased from 9.4 to 9.1 million tonnes between 2003 and 2007 and from 7.9 to 7.6 for the EU15. There are large differences in pressure from agriculture between Member States; areas with a high nutrient pressure include among others the Netherlands, Belgium-Flanders, France-Brittany and Northern Italy. The five regions involved in this project account for more than 70% of livestock in Italy: 68% dairy cattle, 61% other cattle, 85% pigs and 80% poultry.

2. Materials & Methods

The general objective of the LIFE+ AQUA project will be fulfilled through a combination of techniques and practices applied at farm level. For this purpose, 9 real scale demonstration farms were selected according to typical livestock production in each region.

Table 1: Distribution of demonstrative farms

Livestock	Piedmont	Lombardy	Emilia-Romagna	Veneto	Friuli Venezia Giulia	Total
Dairy cattle		1	1	1	1	4
Beef cattle	1			1		2
Pigs	1	1	1			3
Total	2	2	2	2	1	9

In each farm the following actions, already proved by research, will be applied:

- nitrogen in manure will be reduced using feeding techniques based on low-protein diets for pigs and high levels of efficiency in nitrogen intake for dairy and beef cattle. The reduction of the nitrogen excreted will be verified from barn – gate N balance;
- in each demonstration farm, the efficiency of manure fertilisation will be improved at field level through the use of slurry spreading techniques not commonly applied in the area (such as fertigation with clarified slurry mixed with water, shallow injection between rows of growing crops, etc.), maximising the efficiency of nutrient use (N-P), promoting manure application to rotation of crops with a long growing season and high N uptake (as requested for Italian derogation farms in the Decision 2011/721/EU. The European Commission granted the

derogation requested to allow a higher amount of livestock manure than that provided for in the first sentence of the second subparagraph of paragraph 2 of Annex III to Directive 91/676/EEC). The improvement in the N management at farm level will be quantified through the calculation of the farm-gate N balance;

- The economic and environmental impact of the application of these techniques in the area will be assessed through the economic balances and LCA analysis of the nine demonstration farms.

3. Results & Discussion

Currently, the nine farms have been identified and are being monitored before the introduction of the changes in the feeding techniques or in the field rotation and manure application.

At the beginning of 2012 the new procedures will be introduced and for the next two years the expected results are: i) to reduce the nitrogen excreted by about 10-20%, with the introduction of the new feeding techniques depending on the type of livestock reared, without compromising the production performance and decreasing the ammonia emissions (Fabbri et al., 2009) ii) to reduce by about 10-20% the N surplus at farm level, reducing field losses through the above mentioned techniques (Mantovi et al., 2007, 2009, 2010).

4. Conclusion

The LIFE+ AQUA project will demonstrate to farmers and the extension services how it is possible to make use of new technologies and tools to reduce the environmental impact of livestock production, while maintaining productivity and income. All project activities had started and the new procedures will be introduced in the demonstration farms during February 2012.

References

- Ecologic (2010). Assessment of agriculture measures included in the draft River Basin Management Plans <http://ec.europa.eu/environment/water/quantity/pdf/summary050510.pdf>
- European Commission (2011). SEC (2011) 909 - REPORT FROM THE COMMISSION TO THE COUNCIL AND THE EUROPEAN PARLIAMENT On implementation of Council Directive 91/676/EEC concerning the protection of waters against pollution caused by nitrates from agricultural sources based on Member State reports for the period 2004-2007.
- European Environment Agency (2010). The European environment — state and outlook 2010 (SOER 2010), Freshwater quality.
- European Commission (2011). Commission Implementing Decision of 3 November 2011 on granting a derogation requested by Italy with regard to the Regions of Emilia Romagna, Lombardia, Piemonte and Veneto pursuant to Council Directive 91/676/EEC concerning the protection of waters against pollution caused by nitrates from agricultural sources (Decision 2011/721/EU). Official Journal of the European Union, L 287/36, 4 November 2011.
- Fabbri C., Moscatelli G., Della Casa G. and Poletti E. 2009. Interventi sulla dieta per ridurre l'azoto escreto nei suini pesanti in fase di finissaggio. *Suinicoltura* 4, 123-131
- Mantovi P. 2007. L'efficienza dell'azoto in azienda si può migliorare. *L'Informatore Agrario* 37, 49-52.
- Mantovi P., Ligabue M. and Tabaglio V. 2007. Nitrate content of soil water under forage crops fertilised with dairy slurry in nitrate vulnerable zone. Proceedings of the 14th Symposium of the European Grassland Federation. Ghent, Belgium, 3-5 September 2007. *Grassland Science in Europe* 12, 347-350.
- Mantovi P., Fabbri C. and Bonazzi G. 2009. Increase in the nitrogen efficiency using drip lines to apply the liquid fraction of pig slurry. Proceedings of the 16th N Workshop, Turin, 28th June-1st July 2009, 365-366.
- Mantovi P., Bortolazzo E. and Tabaglio V. 2010. Il liquame bovino su prato non comporta perdite di nitrati. *L'Informatore Agrario* 66, 44-47.

NITIRSOIL: a new N-model to estimate monthly nitrogen soil balance in irrigated agriculture.

De Paz, JM.^a, Ramos, C.^a, Visconti F.^{b,a}

^aCentro para el Desarrollo de la Agricultura Sostenible (CDAS), Instituto Valenciano de Investigaciones Agrarias (IVIA). Valencia (Spain)

^bCentro de Investigaciones sobre Desertificacion-CIDE (CSIC, UVEG, GV). Valencia (Spain)

1. Background & Objectives

Several N simulation models with different levels of complexity from simple screening tools to research applications have been developed during the last decades. The applicability of a model is related to its complexity. The high data requirements of complex models reduce their applicability to specific conditions. On the contrary, simpler models can be used under wider conditions. For fertilization recommendation purposes the model should be simple enough to make good recommendations adapted to the local fertilizer practices, conditions and information availability. In this sense we planned the objectives of this work to develop a simple N model on a monthly basis (NITIRSOIL) oriented to make fertilizer N recommendations.

2. Materials & Methods

The algorithms of NITIRSOIL were developed using Visual Basic .net. The implementation of the algorithms was oriented to be as flexible as possible. A graphical user interface-GUI was designed to allow the non-specialist to use the model. Datasets of soil, climate, and nitrate in irrigation water for all the irrigated areas of the Valencian Community were integrated in the model.

Month	Dose (kg/ha)	Fertilizer	Type of Application
Decemb	600	Ammonium sulfate	Surface

It	Month	N month	Dose	Fertilizer	N total	N-NO3	N-NH4	Form	Application type
1	Dec...	12	600	Ammonium sulfate	123.6	0	123.6	solid	Surface

Figure 1. Graphical User Interface (GUI) of the NITIRSOIL model.

The monthly water balance of NITIRSOIL is simulated using the algorithms of the SALTIRSOIL model (Visconti et al., 2011), and the main N balance routines were adapted from the NLEAP model (Shaffer et al., 2010). The crop uptake routine was programmed using the dilution curve concepts (Greenwood et al., 1986) with the following equation.

$$\%N = C1 \text{ TDM}^{-C2}$$

The total dry matter (TDM) production was estimated as function of fresh production and the harvest index (HI). The temporal development of dry matter production was assumed to be a

sigmoidal. The crop parameters (C1, C2) are being calibrated for the main regional crops. NITIRSOIL assess the NUE index as $N_{uptake} / (N_{min\ soil\ at\ planting} + N_{irrigation} + N_{fertilizer})$, to calculate the system N use efficiency.

3. Results & Discussion

The crop parameters of NITIRSOIL were calibrated to adjust to the observed N uptake for some vegetables crops in the Valencian Community (potato, onion, artichoke, cauliflower, and lettuce). Work is in progress to calibrate crop parameters for the main vegetables crops in this region. After this preliminary calibration, the NITIRSOIL was validated for N-NO₃ leaching and N crop uptake (Figure 2). Although the observed data were obtained on a daily basis while the model simulates average monthly values, measurements were comparable to predictions. With this validated model, the main terms of the N balance and the mineral N-NO₃ in soils can also be predicted. This information can be used to evaluate the impact of N fertilization in crops and the environment and to recommend N fertilization management.

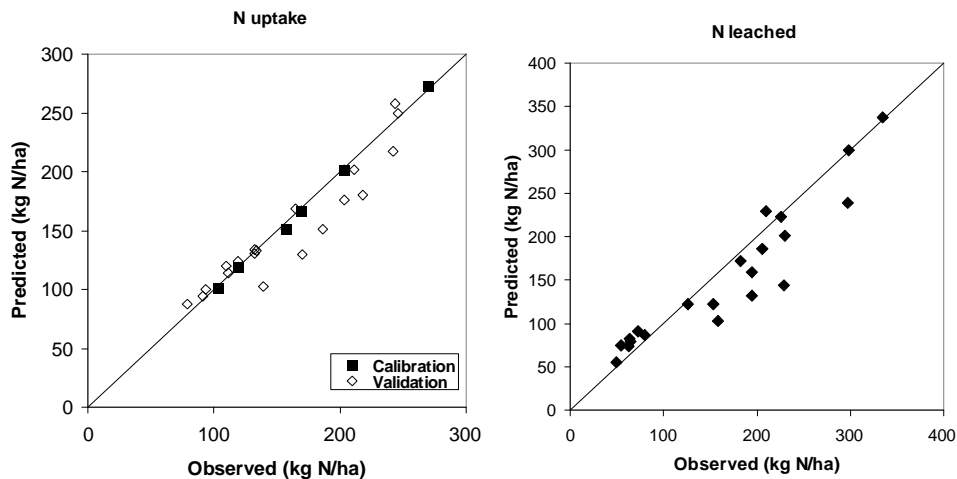

Figure 2. Preliminary calibration and validation of NITIRSOIL for N uptake and leached N-NO₃.

4. Conclusion

A new N model NITIRSOIL has been developed. This model was designed to predict the N monthly balance in irrigation soils. The crop parameters of the model were calibrated and the main N balance terms adequately validated for several vegetable crops. The NITIRSOIL provides a tool for farmers to make fertilizer recommendations and also to evaluate the impact on crops and the environment.

References

- Greenwood, D.J., Neeteson, J.J. and Draycott, A. 1986. Quantitative relationships for the dependence of growth rate of arable crops to their nitrogen content, dry weight and aerial environment. *Plant and Soil* 91, 281-301.
- Shaffer, M.J., Delgado, J.A., Gross, C.M., Follet, R.F. and Gagliardi, P. 2010. Simulation Processes for the Nitrogen Loss and Environmental Assessment Package, In: Delgado, J.A., Follet, R.F., (eds.), *Advances for Nitrogen management for water quality*, Soil and Water Conservation Society, US.
- Visconti, F., de Paz, J.M., Rubio, J.L. and Sanchez, J. 2011. SALTIRSOIL: a simulation model for the mid to long-term prediction of soil salinity in irrigated agriculture. *Soil Use and Management* 27, 523-537.

Strategies to reduce N losses to water from agriculture: experiences from on-farm case studies in the N-TOOLBOX project

Cooper, J.M.^a, Gascoyne, K.^a, Kidd, J.^a, Kristensen, H.L.^b, Maturano, M.^c, Quemada, M.^c, and van der Burgt, G.J.^d

^a Nafferton Ecological Farming Group, School of Agriculture, Food and Rural Development, Newcastle University, Stocksfield NE43 7XD, UK

^b Dept. of Food Science, Aarhus University, Kirstinebjergvej 10 DK-5792 Årsløv, Denmark

^c Dpto. Producción Vegetal, ETS Agriculture Engineering, Technical University of Madrid, Avda. Complutense s/n, 28040 Madrid, Spain.

^d Louis Bolk Institute, Driebergen, The Netherlands

1. Background & Objectives

The movement of nitrates into groundwater and surface water from agricultural sources has been identified as a major environmental and health issue within the European Union. The Nitrates Directive was adopted in December 1991 as a tool to address this issue and the Water Framework Directive was more recently implemented. The N-TOOLBOX project began in 2009 in response to a call from the EU for a project to improve uptake of the Nitrates Directive at the farm level. The project brings together partners in the UK, The Netherlands, Denmark and Spain. Its overall aim is to develop a “toolbox” of cost-effective technologies to be implemented at the farm level to protect water from nitrate pollution. Each project partner is working with farmers to test strategies while noting the techniques that effectively engage farmers in the problem-solving process.

2. Materials & Methods

In 2010 and 2011 all four project partners implemented case studies within a selected region of their country, in order to test out the “N-TOOLBOX” approach with farmers. The approaches used in each country varied, and depended on local conditions and knowledge, farmer interests, and the skills and experience of the project scientists. In the Eden Valley region of the UK four participating farmers in 2009 and three in 2010 compared different methods for optimizing fertilizer rate recommendations with their current practice, using test plots of cereals on their farms. In Spain three farms were selected for testing the following strategies: 1) determining optimal fertilizer rates using decision support tools and accounting for soil N supply, 2) replacing intercrop fallow by cover crops, and 3) rotation of crops with high and low N requirements. In The Netherlands case studies were conducted with vegetable farmers on sandy soils, using the NDICEA model (Burgt et al., 2006) to optimize fertilizer rates. In Denmark case studies were performed on three vegetable farms. Reduced rates of nitrogen fertiliser (conventional management) or liquid manure (organic management) based on NDICEA modelling were compared with farmer’s practice, as well as the effect of autumn catch crops compared to winter fallow. At all sites field N dynamics were monitored using a combination of soil, plant and water sampling. Results from some case studies were simulated using the NDICEA model and findings presented to farmers at information meetings.

3. Results & Discussion

In the UK no single method for optimizing fertilizer recommendations was best on all farms. There were significant Farm x Treatment effects for grain and straw yields and fertilizer N use efficiency (kg grain kg N fertilizer⁻¹). On one of the study farms, the current farmer practice was already resulting in optimum fertilizer use efficiency and maximum economic returns. In contrast, on another farm, relatively low rates of fertilizer were used and while N use efficiency was relatively

high, an economic analysis indicated that profitability could be improved with higher rates of N fertilizer. The case studies served to demonstrate the wide range of approaches for determining fertilizer rates currently used by farmers, and the potential for optimizing rates on many farms.

In Spain adjusting the fertilizer rate to crop N demand based on N supply allowed reductions in N fertilizer without losses in crop yield. In the two farms where the strategy was tested residual N at harvest was reduced. The use of cover crops to take up residual N at the end of the maize growing season greatly reduced nitrate leaching in a wet intercrop period, while it had no effect in years with low winter precipitation. Rotation of summer (high N demand) and winter (low N demand) crops allowed reducing N fertilizer application and leaching risk but decreased farm profitability. The case studies showed that farmers are already adjusting N fertilizer rates to crop needs but there is still a margin for reducing N application by about 20%. Rotation of crops with high and low N requirements is already adopted by farmers to improve water use efficiency, while replacing the intercrop fallow period with a cover crop is not commonly used due to a lack of experience and/or the extra expenses.

In The Netherlands the NDICEA model was useful for demonstrating the impacts of improved practices to farmers. While the NDICEA tool could effectively predict N dynamics on vegetable farms, recommendations were not always taken up. The main reasons for this were: 1) the farmer being unfamiliar with the model, 2) using the surplus of nitrogen as insurance in case of unexpected weather (excess of rainfall), and 3) the farmer relying on his own experience.

In Denmark reduced fertilizer rates did not affect crop yields compared to farmers' practice and the reduced rates and autumn catch crops decreased the risk of nitrate leaching. Identification of high levels of soil nitrate in spring made farmers realise that reductions in rates of fertiliser are possible without yield reductions. Cooperation was established with the extension service and led to demonstration workshops with advisors and farmers on the use of NDICEA.

4. Conclusion

The overall results of the case studies demonstrated that linking scientists with farmers can lead to reduced nitrogen losses by leaching. Scientists gain useful insights into the state-of-the-art currently in use on local farms. Farmers provide candid and direct feedback about results of academic studies. In particular, it was clear that NDICEA is most likely to be useful as a decision support tool when used by trained advisors, rather than by farmers themselves.

The N-TOOLBOX project identified a range of strategies that have been proven to effectively reduce losses of N to water from farms. More direct interactions between farmers, advisors and scientists are now needed to encourage uptake of these measures at the farm level (Barnes et al., 2009). A key factor in this process will be the use of on farm case studies to demonstrate these techniques and empower farmers to make choices about the most appropriate strategy for conditions on their own farms.

References

- Barnes A.P., Willock J., Hall, C. and Toma L. 2009. Farmer perspectives and practices regarding water pollution control programmes in Scotland. *Agricultural Water Management* 96, 1715-1722.
- Burgt G.J.H.M. van der, Oomen G.J.M., Habets A.S.J. and Rossing W.A.H., 2006. The NDICEA model, a tool to improve nitrogen use efficiency in cropping systems. *Nutrient Cycling in Agroecosystems* 74, 275-294.

4 SESSION

Knowledge Transfer

Poster Presentations

“Reliquat Virtuel”: a new decision support tool to predict the soil inorganic N pool

Damay, N.^a, Le Roux, C.^a, Gaillard, J.^b, Machet, J.M.^c,

^a*Laboratoire Départemental d'Analyse et de Recherche de l'Aisne (LDAR), Laon, France*

^b*Institut Technique français de la Betterave industrielle (ITB), Paris, France*

^c*INRA, Unité Agro-Impact, Laon, France*

1. Background & Objectives

The main way to calculate fertilizer-N rates to be applied to annual crops is the predictive balance sheet method which is the basis of many decision support tools used by advisors, soil laboratories or farmers. Among these tools, AzoFert® is a software package widely used in northern France since 2005 (Machet et al., 2007). AzoFert® is based on a complete inorganic N balance sheet. It integrates from climatic data a dynamic simulation of soil N supplies and takes into account processes (immobilization and volatilization of ammonia) affecting the availability of fertilizer-N. Input data include soil type, previous crop, current crop, and farming techniques, easily collected from an information sheet completed by farmers. The annual climate and all necessary data characterizing the different soil types and crops are integrated into the software settings. The soil inorganic N pool at the opening of the balance sheet (usually measured between January and March) is also required as an input. This pool at field scale is either measured at rooting depth or, by default, taken from annual publications. Because of organization, time and costs, all fields of a farm cannot be analyzed.

Another solution is to simulate the soil inorganic N pool at the opening of the balance sheet. Consequently, a new decision support tool “Reliquat Virtuel” is being developed, using the concepts and algorithms of AzoFert® software adapted to the intercropping period. That new tool could be used to improve accuracy of N recommendation without measurement of the soil inorganic N pool and to guide farmers on the choice of fields to measure.

2. Materials and Methods

A first prototype version of “Reliquat Virtuel” has been developed, by adapting the calculation algorithms, parameters and input data of AzoFert® software. The main effort was to take into account the different N fluxes occurring during the intercropping period (from harvest of the previous crop until the opening of the balance sheet). Two modules, one to determine the N mineralization of humified organic matter and the other to determine nitrate transport, were added to the module simulating the contribution of crop residues, catch crops and organic products to N mineralization.

Mineralization of humified organic matter is assumed to be confined to the upper layers. The mineralization rate of these layers is a function of a potential rate depending on the humified organic nitrogen pool, soil texture, and soil temperature and moisture (Mary et al., 1999). In addition it is also influenced by cultural technique. The decay of crop residues and organic amendments in the soil results in net mineralization or net immobilization of soil nitrogen. Each crop residue and organic product is characterized by a specific kinetic curve of N and C decomposition. The decay rate of these products depends on the nature of organic residues and soil temperature and moisture conditions (Nicolardot et al., 2001).

Nitrate transport is simulated using the approach proposed by Burns (1976). The transfer of nitrate is described by the complete mixing of the nitrate flowing into the layers with the resident nitrate of each layer, followed by the drainage of the excess water and the leaching of associated nitrate. The soil profile is divided into consecutive layers of 1 cm of depth.

To take into account the presence of winter cereals and/or catch crops, a module that simulates the growth and N absorption by these crops was also introduced.

3. Results

“Reliquat Virtuel” was tested on an experiment carried out in 1991-92 at Estrées-Mons in northern France on a deep loamy soil. The experiment started in August 1991 on a field after the harvest of a winter wheat crop and the wheat straw had been completely removed. Soil cores were taken every 3-4 weeks, from three layers (0-30, 30-60 and 60-90 cm). Soil samples were analyzed to measure water content, NH_4^+ and NO_3^- concentrations.

The relationship between observed and simulated NO_3^- -N contents in each of the three layers was relatively good (Figure 1). At the opening of the balance sheet (mid of February) the simulated inorganic N pool at 90 cm depth ($87 \text{ kg N}\cdot\text{ha}^{-1}$) is close to that measured ($102 \text{ kg N}\cdot\text{ha}^{-1}$).

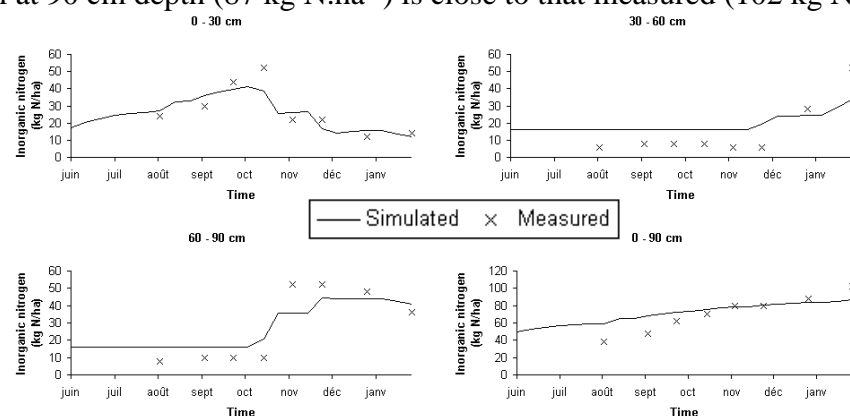

Figure 1. Evolution of observed and simulated (with “Reliquat Virtuel”) nitrate contents in different soil layers

Several tests are in progress for different agro-pedo-climatic conditions encountered in northern France. Our first results are promising for the more common case such as deep loamy soils with or without a catch crop.

4. Conclusion

“Reliquat Virtuel” is a new decision support tool system developed by INRA, LDAR and ITB to predict the N inorganic pool in the soil at the opening of the balance sheet. The first results are promising and for this type of decision tool used at field scale simulation is satisfactory. The next step is to improve the accuracy of the tool and to adapt it to diverse agricultural conditions.

This software should improve the nitrogen fertilization by (1) helping farmers to choose the fields where the N inorganic pool measure is the most useful and (2) providing a valuable solution for all fields of the farm where there is no measure.

References

- Machet J.M. et al. 2007. Azofert : a new decision support tool for fertilizer N advice based on a dynamic version of the predictive balance sheet method. *In* "16th International Symposium of the International Scientific Centre of Fertilizers", pp. 6, Gand.
- Mary, B., Beaudoin, N., Justes, E. and Machet, J.M. 1999. Calculation of nitrogen mineralization and leaching in fallow soil using a simple dynamic model. *European Journal of Soil Science* 50, 549-566.
- Nicolardot B., Recous S. and Mary B. 2001. Simulation of C and N mineralization during crop residue decomposition : A simple dynamic model based on the C:N ratio of the residues. *Plant and Soil* 228, 83-103.
- Burns I.G. 1976. Equations to predict the leaching of nitrate uniformly incorporated to know depth or uniformly distributed throughout a soil profile. *Journal of Agricultural Science* 86, 305-313.

Ammonium nutrition affects the accumulation of winter wheat glutenins

Fuertes-Mendizábal, T.^a, González-Torralba, J.^b, Arregui, L.M.^b, González Murua, C.^a, Estavillo, J.M.^a, González-Moro, M.B.^a

^aDpto Biología Vegetal y Ecología. Universidad del País Vasco (UPV-EHU). Apdo. 644, 48080. Bilbao.

^bDpto Producción Agraria. Universidad Pública de Navarra (UPNA)

1. Background & Objectives

Bread wheat quality is a highly complex feature which is mainly determined by the amount of grain protein and the qualitative composition of that protein. Nitrogen fertilization is the agronomic practice that most widely affects the quality, since the accumulation of reserve protein is influenced not only by the amount of N fertilizer, but also by the type and timing of N source applied.

Nitrogen fertilization improves grain quality due to a rise in grain protein content (Fuertes-Mendizábal et al., 2011). However, the N source or splitting N application has a more variable effect on grain quality. The main objective of this study was to assess the effect of applying exclusively ammonium as the N source split into two or three applications during the crop lifecycle on the composition of the reserve protein fraction responsible for bread dough strength.

2. Materials & Methods

Wheat plants var. Cezanne were sown under greenhouse conditions in 1.5L pots (vermiculite:perlite 1:1). At pre-seeding, 18 mg N were supplied per plant as nitrate (KNO₃) or ammonium ((NH₄)₂SO₄) to simulate the initial soil N availability under field conditions. P, K and S (188, 188 and 129 mg plant⁻¹) were also supplied. Micronutrients and Mg were supplied with the irrigation water (Fetrilon Combi, BASF). The N fertilizer treatments, in Table 1, comprised the same total N application but divided into 2 or 3 applications at different stages along the crop lifecycle according to the Zadoks scale. At harvest, the grain was separated from the straw and milled. Grain N content was determined by combustion with an elemental analyzer (Thermo Finigan). Glutenins were extracted from the flour and separated by RP-HPLC (Figure 1) according to Triboi et al. (2000).

Table 1. N source and rate of the different N-fertilization treatments applied at stages GS20, GS30 and GS37 according to the Zadoks scale.

Treatment	N source	(mg N plant ⁻¹)		
		GS20	GS30	GS37
NS	NO ₃ ⁻	11	27	0
N2S	NO ₃ ⁻	11	16	11
AS	NH ₄ ⁺	11	27	0
A2S	NH ₄ ⁺	11	16	11

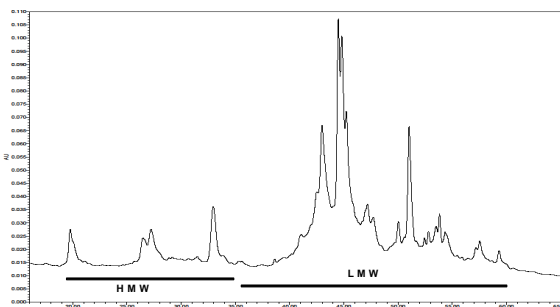

Figure 1. RP-HPLC of var Cezanne glutenins. Peaks eluted after 37 min are LMW-GS, while those eluted before are HMW-GS.

3. Results & Discussion

Nitrogen fertilizer applied as ammonium affected positively the grain protein concentration (GP), increasing it by 17.5% compared to the nitrate treatment (Table 2). Thus, despite receiving the same N rate, plants under NH₄⁺ nutrition produced grains with a higher breadmaking value. Splitting the dose led to an increase in the GP when NH₄⁺ was applied. So, the third application of NH₄⁺ at GS37 significantly improved the grain quality compared to those that received only two, applications and

to those that received NO_3^- , both in two or three applications. Therefore, the use of NH_4^+ as N-source resulted in greater N use efficiency.

Table 2. Nitrogen fertilization management effect on protein and glutenin subunit content. Means in the same column followed by the same letter are not significantly different at $P < 0.05$. ** Interaction N source x splitting at $P < 0.05$.

	Grain Protein (%)		Glutenin area	Glutenin per protein	LMW-GS	HMW-GS	12 9 2 7*				12 9 2 7*				
							(mV*min per mg flour)				(%)				
N SOURCE															
NO_3^-	9.12 a		270.37 a	29.71 a	231.12 a	39.26 a	5.62 a	7.11 a	16.32 a	10.21 a	14.5 a	17.7 b	41.8 b	26.0 a	
NH_4^+	10.72 b		309.73 b	29.03 a	268.01 b	41.72 a	6.89 b	6.26 a	16.11 a	12.45 b	16.5 b	15.0 a	38.7 a	29.8 b	
SPLITTING															
	NO_3^-	NH_4^+	NO_3^-	NH_4^+											
S	9.06 a	10.15 a	257.4 a	290.9 a	28.66 a	237.12 a	37.05 a	5.60 a	6.17 a	15.11 a	10.17 a	15.2 a	16.4 a	41.0 a	27.4 a
2S	9.12 a	11.23 b	283.3 a	328.5 b	30.08 a	262.00 b	43.92 b	6.90 b	7.21 a	17.32 a	12.49 b	15.8 a	16.2 a	39.5 a	28.5 a
NxS	**		**		ns	ns	ns	ns	ns	ns	ns	ns	ns	ns	ns

Ammonium nutrition increased the glutenin content by 15% (Table 2) but the ratio glutenin/protein was not modified. Splitting the NH_4^+ dose also raised glutenin content by 13%, while NO_3^- was applied. The increase in total glutenin content due to NH_4^+ nutrition was related to a rise of 16% in the low molecular weight glutenin (LMW-GS) content. The high molecular weight glutenin (HMW-GS) content showed a similar trend, although not significantly so ($p < 0.09$ instead of $p < 0.05$). Splitting application of NO_3^- or NH_4^+ into 3 doses led to an increase in LMW and HMW-GS content by 10% and 18% respectively. Glutenins are, mainly, responsible for the elasticity of the bread dough, so an increment in their content due to NH_4^+ nutrition led to an improvement in dough strength and breadmaking quality. The polymorphism of HMW-GS is essentially genetically controlled, but the relationship between the different subunits can be influenced by the environment. In this experiment, the application of NH_4^+ changed the quantitative and also the qualitative composition of HMW-GS subunits, favouring the accumulation of subunits 12 and 7*. However, splitting the dose did not change the qualitative composition of the HMW-GS subunits. Therefore, source of N is more important than splitting of the N dose, i.e. the increase in glutenin content due to splitting is not accompanied by a change in glutenin subunit composition.

4. Conclusion

The application of an exclusively ammonium N-source, specially when it is split into 3 doses, increases grain glutenin content and produces flours with increased breadmaking strength.

Acknowledgements

Projects Etortek K-Egokitzen, RTA2009-00028-C03-03 and IT526-10. Authors appreciate the human and technical support of Dr. Azucena González, Phytotron Service Sgiker (UPV/EHU)

References

- Triboi, E., Abad, A., Michelena, A., Lloveras, J., Ollier, J.L. and Daniel, C. 2000. Environmental effects on the quality of two wheat genotypes: 1. Quantitative and qualitative variation of storage proteins. *European Journal of Agronomy* 13, 47-64.
- Fuertes-Mendizábal, T., Aizpurua, A., González-Moro, M.B. and Estavillo, J.M. 2011. Improving wheat breadmaking quality by splitting the N fertilizer rate. *European Journal of Agronomy* 33, 52-61.
- Zadoks, J.C., Chang, T. and Konzak, C.F. 1974. A decimal code for the growth stages of cereals. *Weed Research* 14, 415-421.

Automating fertiliser N management

Kindred, D.^a, Sylvester-Bradley, R.^a

^aADAS UK Ltd., Battlegate Road, Boxworth, Cambridge

1. Background & Objectives

Current decision support systems for fertiliser N management are disturbingly ineffective (Kindred et al., 2012; Sylvester-Bradley et al., 2008). Precision Agriculture has long held the promise of improving fertiliser management, and there has been considerable commercial success using canopy sensing techniques to variably apply N across a field (e.g. Heege et al., 2008). However, these generally make arbitrary adjustments to N rate, rather than estimating the absolute N requirement of the crop. It is proposed here that precision farming technologies (e.g. on-combine yield and protein sensors, canopy sensing, soil electro-magnetic induction) might be integrated for two purposes: (a) to provide a novel approach to experimentation, whereby soil effects can be tested with common varieties, husbandry and weather, hence understanding of N requirements can improve, and (b) to provide an automated system for commercial N management both within and between fields, based on the best N management principles, without involving arbitrary adjustments. The variability in N requirements within fields has been assessed rarely (Lark and Wheeler, 2003) and to our knowledge the variability in components of N requirements has never been dissected. A chequerboard design (Pringle et al., 2004) has been adopted here to quantify variation in N requirements and better understand the relative importance of its components.

2. Materials & Methods

A clay loam field was selected in 2010 containing three similar soil series (Evesham, Worcester & Fladbury) and showing previous variability in grain yield fairly typical of yield-mapped fields in England. Fertiliser was applied with 10 m farm spreader booms set separately and perpendicular passes were used to give 528 10 m x 10 m plots fertilised with 0, 120, 240 or 360 kg N ha⁻¹. Yield was measured by plot combine and samples taken for protein analysis. Whole plant grab samples taken from each plot gave N harvest index and total N uptake. Yield and grain protein data were kriged to estimate yield and protein in each plot, then exponential response curves were fitted for each plot allowing N optima to be determined, assuming a price ratio of 5 kg grain to 1 kg fertiliser N.

3. Results & Discussion

An aerial view and mapped results (Figure 1) show a number of distinct zones running across the trial area, differing in their greenness in the zero-N plots and in their yield both with and without fertiliser. Grain yield varied from 4 to 8 t ha⁻¹ without N fertiliser and from 8 to 12 t ha⁻¹ where N was applied. N optima varied from 110 to 210 kg N ha⁻¹. Differences in N optima were mostly associated with differences in SNS, which ranged from 60 to 180 kg N ha⁻¹. There were differences in N demand (yield) and N recovery, but these did not usefully explain the differences in N optima; where yields were high, SNS tended to also be high so optima were low. N recovery was similarly confounded.

This trial showed substantial variation in N requirement in a field considered to have variability representative of English cereal fields; in this case the main surprise was large variation in SNS. However, canopy sensing measurements in March could distinguish the regions that ultimately supplied different amounts of soil N (data not shown). The variation in crop N demand in this trial

also proved predictable using cluster analysis from previous yield maps (Milne et al., 2011), although in this case the information did not directly explain differences in N requirement. This is the first of six chequerboard experiments to be conducted before 2013; the challenge then will be to calibrate and inter-relate canopy reflectance and other potential predictors of N requirements (e.g. soil type, previous crop N offtake) so that they become integrated, predictive and automated.

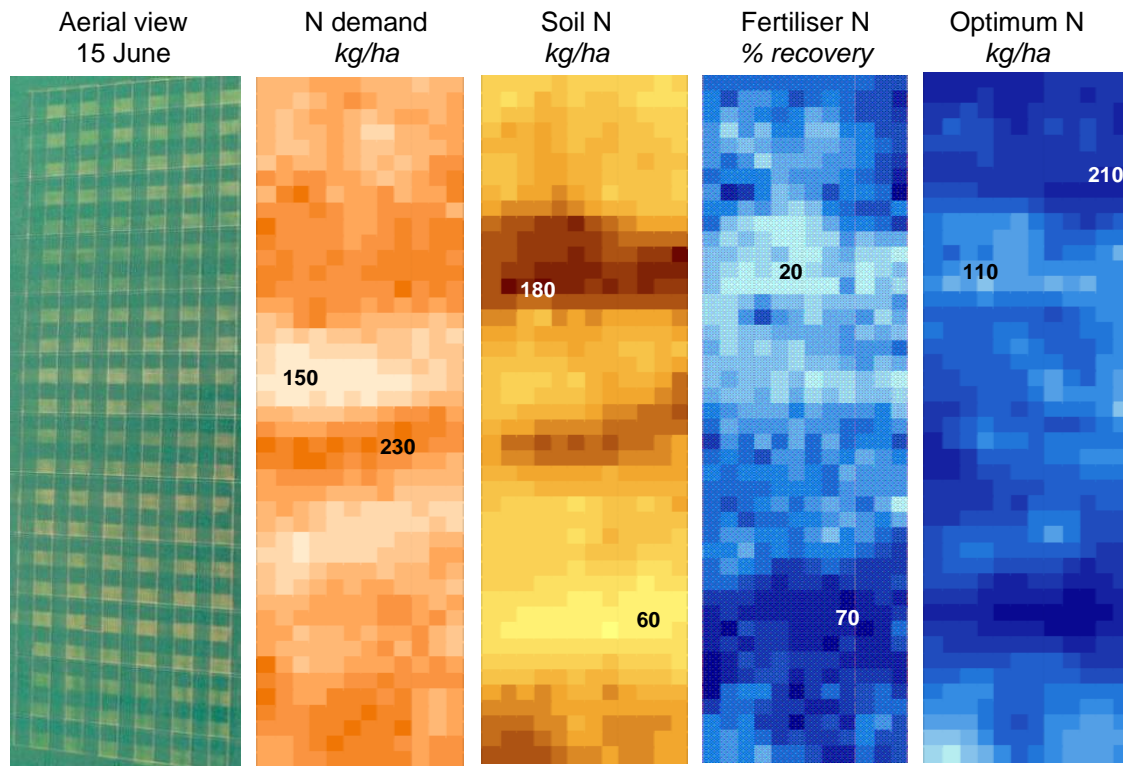

Figure 1. Aerial view of the chequerboard trial at Flawborough, Nottinghamshire in 2010, with similarly scaled maps of optimum applied N and its components (crop N demand, soil N supply and fertiliser N recovery). Colours are graded in equal intervals between the extremes of each variable; these being indicated on each map.

Acknowledgements

This research is sponsored by the UK Department for Environment, Food and Rural Affairs through Sustainable Arable LINK Project LK09134, with contributions from ADAS, Rothamsted Research, NIAB-TAG, AgLeader, BASF, Farmade, FOSS, HGCA, Hill Court Farm Research, Masstock, Precision Decisions, Soil Essentials, SOYL, Yara, & Zeltex Inc.

References

- Heege, H.J., Reusch, S. and Thiessen, E. 2008. Prospects and results for optical systems for site-specific on-the-go control of nitrogen-top-dressing in Germany. *Precision Agriculture* 9, 115.
- Kindred, D., Knight, S., Berry, P., Sylvester-Bradley, R., Hatley, D., Morris, N., Hoad, S. and White, W. 2012. Establishing Best Practice for Estimation of Soil N Supply. HGCA Research Report on Project 3245 (in press).
- Lark, R.M. and Wheeler, H.C. 2003. A method to investigate within-field variation of the response of combinable crops to an input. *Agronomy Journal* 95, 1093-1104.
- Milne, A., Webster, R., Ginsburg, D. and Kindred, D. 2011. Spatial multivariate classification of an arable field into compact management zones based on past crop yields. *Computers and Electronics in Agriculture* 80, 17-30.
- Pringle, M.J., McBratney, A.B. and Cook, S.E. 2004. Field-scale experiments for site-specific crop management. Part II: A geostatistical analysis. *Precision Agriculture* 5, 625.
- Sylvester-Bradley, R., Kindred, D.R., Blake, J., Dyer, C.J. and Sinclair, A.H. 2008. Optimising fertiliser nitrogen for modern wheat and barley crops. Project Report No. 438, HGCA, London. 116 pp.

Comparing the efficiency of CAN, urea and urea + agrotain (*n*-butyl thiophosphoric triamide) as N fertiliser in grassland

Antille, D.L.^a, Hoekstra, N.^a, Lalor, S.T.J.^a

^aTeagasc, Johnstown Castle, Environmental Research Centre, Co. Wexford, Republic of Ireland.

1. Background & Objectives

In Ireland, calcium ammonium nitrate (CAN) and urea-based fertilisers account for *c.*60% of the total fertiliser N applied on managed grassland (Lalor et al., 2010). Urea-based fertilisers have relatively low cost, high N content and suggested lower susceptibility for NO₃⁻ leaching and denitrification than CAN (Jordan, 1989). They have, however, high potential for NH₃ volatilisation resulting in lower yield potential (Watson et al., 1990). Agrotain acts as an effective inhibitor of urease activity reducing N-losses through ammonia volatilisation. A general view is that the agronomic efficiency of urea-based fertilisers is more uncertain than CAN; however, their relative efficiencies can vary significantly when the fertilisers are applied in the spring (Bussink and Oenema, 1996). This can be unequally affected by meteorological conditions around the time of fertiliser application. At present, limited information is available explaining these relationships under Irish conditions as well as the effect of the use of agrotain on dry matter yield (DMY). The aim of this work was to determine the relative efficiency of urea, and urea + agrotain compared with CAN in relation to the weather and soil conditions for a range of fertiliser application timings.

2. Materials & Methods

The experiment used 3 fertiliser treatments (urea (U), urea coated with agrotain [*n*-butyl thiophosphoric triamide at 0.48 g kg⁻¹] (UA) and CAN (C)), 4 N-application rates (0 – control, 25, 50 and 75 kg [N] ha⁻¹), and 19 application timings which were performed once every week from February to April and once every fortnight from May to September. A complete block design with 4 blocks was used; within each block, application timing was the plot factor resulting in 19 strips so that fertiliser treatment × rate was randomised within the strip. Plots dimensions were 3 m by 1 m marked out on a moderately well drained soil at Teagasc, Johnstown Castle, Wexford, in February 2010. Grass was cut for DMY at weeks 4 and 8 after fertiliser application. The statistical analysis of the data involved ANOVA and the LSD (5% level) to compare the means. The relative DM yields (RY) and relative N-uptake (RN_{upt}) of U and UA compared with C were estimated based on Eq. [1]:

$$RY, RN_{upt} = \frac{(F - NF)}{(CAN - NF)} \times 100 \quad [1]$$

where: F and NF correspond to DMY or N_{upt} of the fertiliser treatment and the control (zero-fertiliser) respectively.

3. Results & Discussion

Figures 1 & 2 show, respectively, the relative DMY and N-uptake of U and UA compared to CAN (100%) corresponding to the cuts made at 4 and 8 weeks after fertiliser application. Overall, there were significant differences (*p*<0.05) in DMY with respect to the timing, the N-application rate and the fertiliser type (except for 2nd cut made at week 8; *p*>0.05). The interaction timing × fertiliser type was nonsignificant (*p*=0.96) indicating that the differences in DMY encountered between the control (zero-N) and the treatments were of similar order of magnitude at any given time. The use of U and UA resulted, overall, in relative DMY values between 7%-11% and between 0%-7% lower compared with CAN. The use of UA improved the agronomic performance of urea-N by *c.*5% across the entire range of timings and fertiliser rates used in this experiment.

By aggregating the data shown in Figure 1, it can be seen that U and UA performed better than CAN for applications made between the middle of March and early April, and also early May. This effect may be attributed to the particular weather conditions (rainfall and temperature) and soil moisture content recorded in the following 3 days post-fertiliser application. These influenced the magnitude of the N losses from the fertiliser-N applied and the residual N used up by the crop in the period between the 1st and 2nd cuts. N-uptake by the crop showed, overall, that there were significant differences ($p < 0.05$) with respect to the timing, the N-application rate and the fertiliser type. The interaction timing \times fertiliser type was also significant ($p < 0.05$) for U and UA compared with CAN, particularly, for the fertiliser applications made between late March and early April, and in early May (Figure 2). This effect is associated to the larger relative DMY of U and UA recorded for these fertiliser treatments. In most circumstances, the grass crop responded linearly to the application of N-fertiliser for the range of N rates used in this experiment (p -values < 0.05 for the linear models fitted to the data).

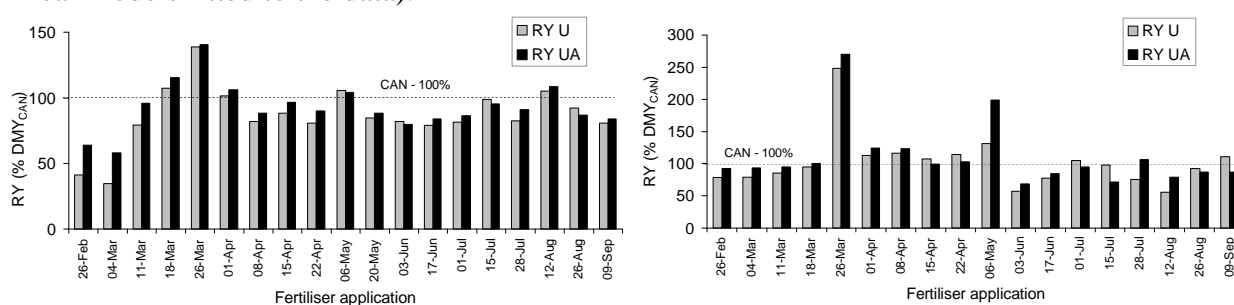

Figure 1. DMY of U and UA relative to CAN four weeks (left) and during the period between four and eight weeks (right) after fertiliser application.

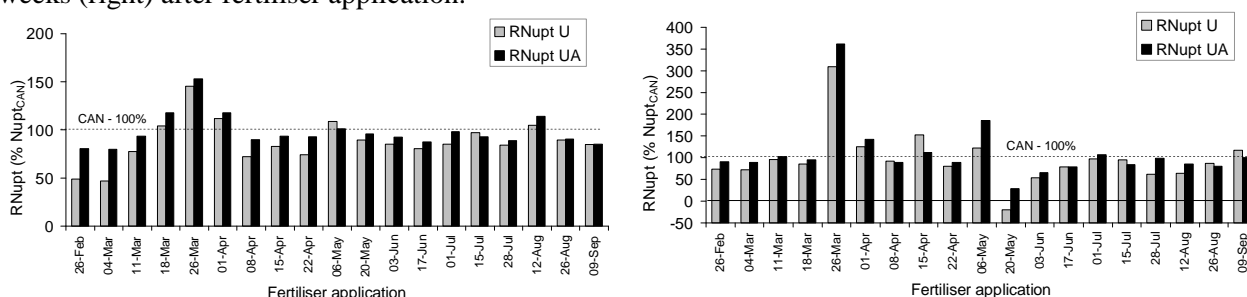

Figure 2. N-uptake of U and UA relative to CAN four weeks (left) and during the period between four and eight weeks (right) after fertiliser application.

4. Conclusions

In general, the use of CAN performed marginally better than U and UA regardless of the timing of fertiliser application except for N-applications made, approximately, between middle of March and early April. Economic analyses are also required to justify the fertiliser choice.

References

- Bussink, D.W. and Oenema, O. 1996. Differences in rainfall and temperature define the use of different types of nitrogen fertilizer on managed grassland in UK, NL and Eire. *Neth. J. Agric. Sci.* 44, 317-338.
- Jordan, C. 1989. The effect of fertiliser type and application rate on denitrification losses from cut grassland in Northern Ireland. *Fert. Res.* 19, 45-55.
- Lalor et al., 2010. A survey of fertilizer use in Ireland from 2004-2008 for grassland and arable crops. Teagasc, 21pp.
- Watson et al., 1990. Efficiency and future potential of urea for temperate grassland. *Fert. Res.* 26, 341-357.

Effect of a green compost extract added to rabbit feed on nitrogen balance and ammonia and nitrous oxide emissions from stored slurry

Dinuccio, E.^a, Biagini, D.^b, Rosato, R.^c, Balsari, P.^a, Lazzaroni, C.^b, Montoneri, E.^c

^aDEIAFA, University of Torino, Via L. da Vinci 44, 10095 Grugliasco, Italy

^bDipartimento di Scienze Zootecniche, University of Torino, Via L. da Vinci 44, 10095 Grugliasco, Italy

^cDipartimento di Chimica Generale e Chimica Organica, University of Torino, Corso M. D'Azeglio 48, 10125 Torino, Italy

1. Background & Objectives

Much of the nitrogen in animal diets is not retained but is found in manure, the major source of N pollution. Increasing efficiency of N use by the animal and reducing N losses to the environment from manure handling are objectives to increase livestock system sustainability. Green compost, rich in humic acid-like substances resulting from decomposition of organic matter, could influence chemical forms of N and their fate (Islam et al., 2005). The objective of this study was to evaluate the effect of a green compost extract as an additive to fattening rabbit diets on N balance, and ammonia (NH₃) and nitrous oxide (N₂O) emissions from stored slurry.

2. Materials & Methods

Three groups of homogeneous rabbits were reared from 35 to 98 d of age under the same environmental conditions, fed iso-energetic (digestible energy 9.1 MJ kg⁻¹ fresh weight) and iso-nitrogenous (crude protein 160 g kg⁻¹ fresh weight) diets containing a green compost extract, with a high content of soluble bio-organic (SBO) substances (Montoneri et al., 2011), obtained by an experimental plant. The SBO content of the diets varied: control (DC, no SBO), low (DL, 0.5g kg⁻¹) and high (DH, 2.5 g kg⁻¹). During the experimental period (63 d), individual live weights and feed consumption were recorded weekly. Nitrogen balance was calculated according to ERM/AB-DLO (1999). Total N excreted over the experimental period was calculated as the difference between N in consumed feed and N retained in body weight gain (Maertens et al., 2005). To assess the effect of SBO addition to diets on NH₃ and N₂O emissions from stored slurry, after a period of adaptation to diets (31 d), faeces and urine excreted by 6 rabbits per diet were collected separately during 6 consecutive days. After the collection period, faeces and urine within the same diet were accurately mixed in a ratio of 1:4 by fresh weight. Then, samples of 0.50 kg of each mix (slurry) were placed in 1.5 L vessels (Ø 11.3 cm) and stored for a period of 25 d at room temperature (24.4±1.6 °C). Ammonia and N₂O emissions were measured by a dynamic chamber method using a gas trace analyser (1412 Photoacoustic Multi-gas Monitor, Innova Air Tech Instruments), following Dinuccio et al. (2008), in 21 sessions on 6 replicates per diet. At the beginning and end of the trial, representative slurry samples were analysed for pH, total solids (TS), total Kjeldhal N (TKN), and total ammonia N (TAN). Data were analysed by GLM univariate according to diet, and differences were tested by Duncan's test (SPSS Statistics 17.0).

3. Results & Discussion

The SBO addition to diets did not affect (P>0.05) live performance or N utilization efficiency, the latter averaged 30.39±2.04 % between treatments. Likewise, there was no effect (P>0.05) of SBO addition on the amount of faeces and urine produced by rabbits. The main chemical characteristics of slurries obtained from the different groups, at the beginning and at the end of the storage experiment, are showed in Table 1. At the beginning, the slurries had similar pH and TKN content; however, increasing levels of dietary SBO increased (P<0.05) TS and lowered (P<0.01) TAN concentration in slurry from 2.4 g kg⁻¹ (DC) to 1.8 g kg⁻¹ (DH), while the proportion of TKN

present as TAN ranged ($P>0.05$) from 37% (DH) to 44% (DC). At the end of storage, there was a general increase in TS, still different between diets ($P<0.01$) but higher in DL than in DH, while increased levels of dietary SBO still lowered ($P<0.01$) TKN content, without affecting ($P>0.05$) the TAN/TKN ratio.

Table 1. Main characteristics of slurry (faeces + urine) obtained from control (DC), low (DL) and high (DH) SBO content diets (mean \pm SD).

Time	Characteristic	DC	DL	DH
beginning of storage	pH	9.02	9.05	8.93
	TS (% fresh wt)	12.04 \pm 0.17 b	12.31 \pm 0.08 a	12.32 \pm 0.04 a
	TKN (% fresh wt)	0.55 \pm 0.06	0.59 \pm 0.01	0.50 \pm 0.02
	TAN (% fresh wt)	0.24 \pm 0.00 A	0.23 \pm 0.00 A	0.18 \pm 0.01 B
end of storage	TAN/TKN	0.44 \pm 0.05	0.38 \pm 0.01	0.37 \pm 0.02
	TS (% fresh wt)	20.82 \pm 0.37 B	21.96 \pm 0.36 A	21.24 \pm 0.61 B
	TKN (% fresh wt)	0.66 \pm 0.02 A	0.63 \pm 0.01 B	0.60 \pm 0.02 C
	TAN (% fresh wt)	0.11 \pm 0.01	0.12 \pm 0.01	0.11 \pm 0.01
	TAN/TKN	0.51 \pm 0.06	0.54 \pm 0.06	0.50 \pm 0.06

Data in a row followed by a different capital letter differ for $P<0.01$ and by a different lower letter for $P<0.05$.

Total NH_3 emission from stored slurry decreased as SBO level in the diet increased (Table 2). Total NH_3 emission was 27% lower ($P<0.01$) for DH compared to DC treatment, reflecting the difference in TAN content of the slurries at the beginning of the storage. Total N_2O emissions were not influenced ($P>0.05$) by SBO addition to diet.

Table 2. Total emissions of NH_3 and N_2O from the storage of slurry obtained from control (DC), low (DL) and high (DH) SBO content diets (mean \pm SD).

Emission	DC	DL	DH
NH_3 (mg/kg slurry)	3866 \pm 173 A	3717 \pm 164 A	2835 \pm 121 B
N_2O (mg/kg slurry)	27.98 \pm 1.53	28.27 \pm 1.61	28.70 \pm 2.75

Data in a row followed by a different capital letter differ significantly for $P<0.01$.

4. Conclusion

Addition of SBO to fattening rabbit diets (0.25%) reduced TAN in slurry at the beginning of the trial, thereby lowering NH_3 emissions during storage. To estimate the effect of SBO addition to diets on NH_3 and N_2O emissions during the overall manure management, further experiments are currently in progress to evaluate the soil application stage.

References

- Dinuccio E., Berg W. and Balsari P. 2008. Gaseous emissions from the storage of untreated slurries and the fractions obtained after mechanical separation. *Atmospheric Environment* 42, 2448-2459.
- ERM/AB-DLO (1999). Establishment of criteria for the assessment of nitrogen content in animal manures - Final Report. European Commission, Brussels, Belgium.
- Islam K.M.S., Schumacher A. and Gropp J.M. 2005. Humic acid substances in animal agriculture. *Pakistan Journal of Nutrition* 4, 126-134.
- Maertens L., Cavani C. and Petracci M. 2005. Nitrogen and Phosphorus excretion on commercial rabbit farms: calculation based on the input-output balance. *World Rabbit Science* 13, 3-16.
- Montoneri E., Boffa V., Savarino P., Perrone D., Ghezzi M., Montoneri M. and Mendichi R. 2011. Acid soluble bio-organic substances isolated from urban bio-waste: chemical composition and properties of product. *Waste Management* 31, 10-17.
- SPSS 2007. *Statistics Base 17.0 User's Guide*. SPSS Inc, Chicago., IL, USA.

Effect of grapevine canopy management strategies on nitrogen contents in leaf petiole and must nitrogen organic composition of dryland Chardonnay grapes

Pascual, M.^a, Villar, J.M.^a, Rufat, J.^b, Fonseca, F.^b, Lordan, J.^{a,b}, Astrain J.^c

^a Universitat de Lleida (UdL), ETSEA, Av Rovira Roure 191, 25198 Lleida, Spain

^b Institut de Recerca i Tecnologia Agroalimentàries, IRTA, Av Rovira Roure 191, 25198 Lleida, Spain

^c Bodega Pirineos, c/ Barbastro-Naval. 22300 Barbastro, Spain

1. Background & Objectives

More than 50% of world grapevine growth under semiarid conditions and are dependents on rainfall. Grapevine management practices have strong effects on grape yield and wine quality. Techniques for water saving are a key factor to improve plant water status and nutrients uptake efficiency. Optimizing canopy management strategies affect the grapevine water availability and nutrients uptake along growing season, contributing to wine quality (Guitart et al., 1997) by enhancement of canopy microclimate characteristics and physiological responses to water status during grapes maturation period (Choné et al., 2001; Van Leuwen et al., 2010). The objective of this paper was to evaluate the effects of canopy management strategies on plant and grape nitrogen (N) and grape composition.

2. Materials & Methods

A two-year field experiment (2009–2010) on grapevine was conducted on an eleven aged Chardonnay vineyard in Somontano region (Northeast Spain). Vineyard was selected according the homogeneity on culture practices and cellar performance classification. Two points into vineyard were selected according the presence of differences on soil texture and organic matter contents. Both soils were classified as Typic Calcixerepts. Three canopy management treatments were random arranged (four replications of 10 plants) on each point (T0, canopy management according common practice: vertical shoot positioning and topping after veraison; LR, leaf removal of fruiting zone at veraison and ST, repeat shoot topping from fruit set). N, N-NO₃, P, K, Mg, Ca and minor elements were analysed in petioles on veraison time. Plant water status was measured as stem water potential (ψ_s) on veraison and at harvest time. Exposed leaf area of canopy was measured by image analysis. Yield, crop load, weight of clusters and berries, berry juice mineral contents, sugars, pH, acids, phenolic compounds, yeast available nitrogen (YAN) and amino acids were analysed at harvest time. Statistical analysis of data was carried out using the SAS-STAT package (SAS®, Version 9.2. SAS Institute Inc., Cary, NC, 1989-2009).

3. Results & Discussion

Petiole N and N-NO₃ increase enhance must contents of YAN, sugars (or alcohol) and pH, and decreases volatile acids, tartaric acid and polyphenols (Table 1). High nitrogen concentration in petiole was related with decreasing of other nutrients, except for Ca. Plant water status on veraison was negatively related to N in petiole and YAN must contents. On the contrary, water availability on maturation period was related positively with N petiole and YAN must contents. Canopy management treatments exhibit a strong effect on must organic nitrogen composition (Table 2). In fact, leaf removal affects significantly to amino acids concentration, while shoot growth control by topping was similar to control. Moreover, amino acids balance was significantly affected by canopy treatments.

4. Conclusions

Grapevine nitrogen uptake was dependent on soil water availability and this was affected by canopy management practices. Both water status as canopy management were interacted affecting must characteristics and amino acids profile and, so, affecting wine vintage effect.

Table 1. Coefficients for Partial least squares regression (PLS2) model relating standardized quality variables (Alcohol contents; pH; Yeast available nitrogen (YAN); Glucose + fructose; acid tartaric, volatile acids and Folín index for polyphenols. Interesting variables in model were selected according variance importance in projection (VIP>0.8) criteria. PLS model includes two components according RMSE adjust and explain 91% of Y response

	VIP	Alcohol	pH	YAN	G+F	Tartaric	Volatile acids	Folín index
Ca	1.20	0.073	0.075	0.032	0.074	-0.080	-0.036	-0.036
Cu	0.80	-0.048	-0.049	-0.021	-0.049	0.053	0.024	0.024
Fe	0.93	-0.056	-0.057	-0.025	-0.057	0.062	0.028	0.028
K	0.69	-0.042	-0.043	-0.019	-0.042	0.046	0.021	0.021
Mg	1.74	-0.105	-0.108	-0.047	-0.107	0.115	0.052	0.052
N	1.74	0.105	0.108	0.047	0.107	-0.116	-0.052	-0.052
N-NO₃	1.72	0.104	0.107	0.046	0.105	-0.114	-0.052	-0.051
P	1.53	-0.092	-0.095	-0.041	-0.094	0.101	0.046	0.046
Zn	0.48	-0.029	-0.030	-0.013	-0.029	0.032	0.014	0.014
Ψs harvest	1.28	0.078	0.080	0.035	0.079	-0.085	-0.039	-0.038
Yield	0.66	-0.015	-0.016	-0.007	-0.015	0.017	0.008	0.007
Cluster weight	0.93	-0.040	-0.041	-0.018	-0.040	0.043	0.020	0.020
Berry weight	1.46	-0.057	-0.058	-0.025	-0.057	0.062	0.028	0.028
Ψs veraison	1.31	-0.088	-0.090	-0.039	-0.089	0.097	0.044	0.043
canopy area	0.46	0.079	0.081	0.035	0.080	-0.087	-0.039	-0.039
Pruning weight	0.68	0.028	0.028	0.012	0.028	-0.030	-0.014	-0.014

Table 2. Results of berry juice amino acid analysis by canopy management treatments. Aspartic Ac., Glutamic Ac., Asparagine, Serine, Glutamine, Histidine, Glycine, Threonine, Arginine, Alanine, GABA, Tyrosine, Valine, Methionine, Tryptophan, Phenylalanine, Isoleucine, Leucine, Lysine, Proline (mg l⁻¹)

	ASP	GIAC	Asp	Ser	Glut	Hist	Gly	Tre	Arg	Ala
LR	9.9	47.9	5.5	68.2	282.7	27.8	4.4	33.3	102.3	73.4
ST	13.0	41.9	9.6	85.2	393.9	34.8	4.8	42.4	130.0	90.2
T0	11.9	45.0	8.2	81.7	395.1	39.3	5.4	42.3	156.8	102.9
	GA	Tir	Val	Met	Try	Fen	Iso	Leu	Lis	Pro
LR	48.4	14.3	7.7	1.4	18.5	9.4	8.0	11.5	4.3	6.4
ST	65.5	16.9	6.1	0.8	14.8	6.9	6.5	8.2	3.1	9.4
T0	74.0	16.8	6.7	0.9	18.1	7.6	6.6	9.1	3.0	7.7

References

- Guitart, A., Hernandez-Orte, P. and J.F. Cacho. 1997. Effects of maceration on the amino acid content of Chardonnay musts and wines. *Vitis* 36, 43-47.
- Choné, X.; C. Van Leeuwen; Dubourdieu, D. and Gaudillère, J.P. 2001. Stem Water Potential is a Sensitive Indicator of Grapevine Water Status. *Ann Bot* (2001) 87 (4), 477-483.
- Van Leeuwen, C., Trégoat, O., Choné, X., Gaudillère, J. and Pernet, D. 2004. Different environmental conditions, different results: the role of controlled environmental stress on grape quality potential and the way to monitor it. Proceedings thirteenth australian wine industry technical conference, 1-8

Effect of nitrogen fertilizer rate on wheat flour extensibility

González-Torralba, J.^a, Ezquerro, A.^a, Goñi, J.^b, Arregui, L.M.^a

^aAgricultural Production Department, Public University of Navarre, Pamplona, Spain

^bINTIA, S.A. (Instituto Navarro de Tecnologías e Infraestructuras Agroalimentarias (Área Agrícola)), Villava, Spain

1. Background & Objectives

Nitrogen (N) fertilization in wheat is essential to obtain the desired grain yield and quality. One of the characteristics of wheat flour that determine its performance during baking is the extensibility. Increases in N fertilizer rate promote increments of dough extensibility (Garrido-Lestache et al., 2004). The objective of this work was to know how this increment is affected by year and genotype.

2. Materials & Methods

Field trials were conducted during five years at three sites in Navarra (northern Spain) under a humid Mediterranean climate with a randomized complete block design with four replications. Five to six N fertilization treatments (urea, 46%) were used, including a control without N fertilization. Plots were rain-fed, except in 2009/10, when they received irrigation. One to four bread wheat cultivars (*Triticum aestivum* L.) were sown. Yield response to N rate (Y) (t ha^{-1} on a 120 g kg^{-1} water basis) was fitted to a quadratic-plus-plateau model, defined by equation 1 and 2.

$$Y = a + bN + cN^2 \text{ if } N < \text{Nop} \quad [1]$$

$$Y = M \text{ if } N \geq \text{Nop} \quad [2]$$

Where N is the fertilizer rate (kg N ha^{-1}), a is grain yield predicted for the unfertilized control treatment, b and c are linear and quadratic coefficients, respectively, and Nop is the intersection of the two functions (the smallest N rate required to reach M , the plateau yield). Grain samples were milled to white flour. Dough extensibility (L) (mm) was assessed by Chopin Alveograph. Extensibility response to N (L) was fitted to a linear model, defined by equation 3.

$$L = d + eN \quad [3]$$

Where N is the fertilizer rate (kg N ha^{-1}), d is the extensibility predicted for the unfertilized control treatment and e is the linear coefficient. Extensibility for Nop treatment (L_{Nop}) was calculated for each year introducing Nop values in equation 3.

3. Results & Discussion

Yield response to N followed a quadratic-plus-plateau model. In contrast, extensibility response to N followed a linear model, indicating that flour quality can be improved by application of N rates higher than Nop . Maximum yield, Nop and L_{Nop} varied among cultivars and years, showing the effects of genotype, site, particularly soil N mineral content before fertilization, weather and management practices like irrigation (Table 1). Despite L models were different for each cultivar and year, linear coefficients were very similar, indicating that in most cases L increase per N fertilizer unit had a value close to 0.3 mm. A different trend observed for Berdún in 2006/07 might be explained by a lower efficiency of N fertilizer. Calculated values that relate N rate and L to Nop and L_{Nop} allowed to establish a single correlation that included all cultivars and years (Figure 1). Extensibility response to N fertilizer was the same within the fertilizer rate range in which N was

still limiting grain yield (N rate < N_{op}) and under non-limiting conditions (N rate > N_{op}), when N absorbed can be used to increase grain N content and breadmaking quality (Johansson et al., 2001).

Table 1. Fitting models of yield (Y) (880 g kg⁻¹ on dry matter basis) and dough extensibility (L) related to N rate (x).

Year	Cultivar	Yield model		N _{op} kg N ha ⁻¹	R ²	L model	L _{N_{op}}	R ²
		(x < N _{op}) kg ha ⁻¹	(x ≥ N _{op}) kg ha ⁻¹					
2005/06	Berdún	Y = -0.11 x ² + 35.1 x + 3651	Y = 6451	159	0.80	L = 0.4 x + 72.5	140	0.95
2006/07	Berdún	Y = -0.02 x ² + 16.1 x + 2275	Y = 4318	151	0.92	L = 0.1 x + 111.1	126	0.42
2007/08	Berdún	Y = -0.02 x ² + 13.0 x + 1711	Y = 3459	190	0.84	L = 0.3 x + 78.2	126	0.90
2008/09	Berdún	Y = -0.11 x ² + 29.5 x + 4419	Y = 6394	139	0.90	L = 0.3 x + 134.1	177	0.86
2009/10	Berdún	Y = -0.09 x ² + 38.5 x + 6045	Y = 9632	130	0.91	L = 0.3 x + 73.5	119	0.92
2009/10	Osado	Y = -0.05 x ² + 39.3 x + 5544	Y = 9706	125	0.89	L = 0.3 x + 100.5	145	0.96
2009/10	Badiel	Y = -0.20 x ² + 63.4 x + 5430	Y = 10143	122	0.91	L = 0.3 x + 40.2	90	0.99
2009/10	Nogal	Y = -0.06 x ² + 46.1 x + 6335	Y = 11226	125	0.94	L = 0.2 x + 71.1	101	0.98

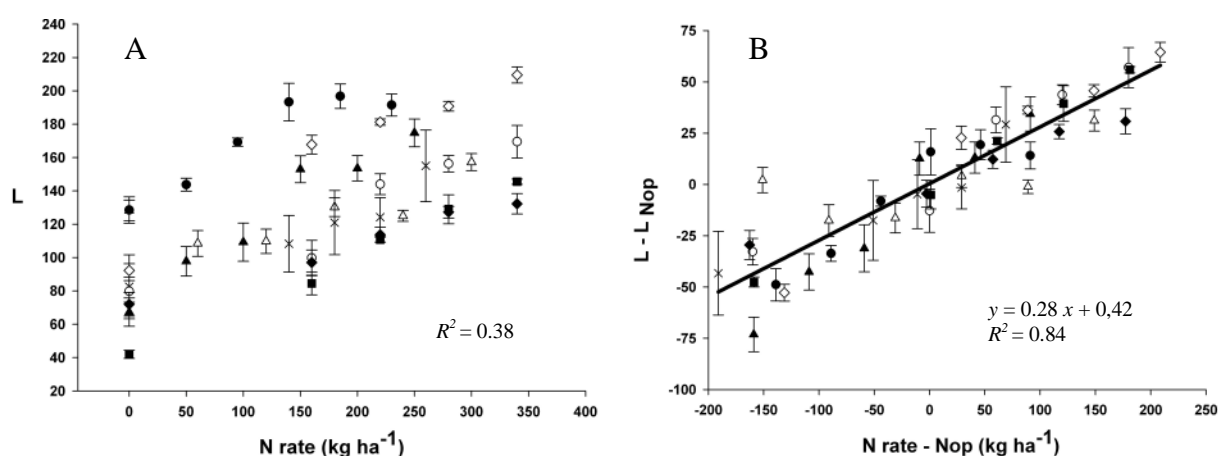

Figure 1. Correlation between N fertilizer rate (kg ha⁻¹) and dough extensibility (mm) (A) and between N rate minus N optimum for yield (N_{op}), and extensibility minus extensibility calculated for N_{op} (B) in Berdún 2005/06 (▲), 2006/07 (Δ), 2007/08 (x), 2008/09 (●), 2009/10 (○), Osado 2009/10 (◇), Badiel 2009/10 (■) and Nogal 2009/10 (◆).

4. Conclusion

Extensibility for each N rate varied among cultivars and years, due to genotype, environmental and soil conditions. Within each cultivar and year, extensibility increased linearly with N rate independent of whether N rate was under or above N_{op}. A single regression could be made for all years and cultivars, indicating an increase of extensibility of 0.3 mm per kg N, approximately.

Acknowledgments

This research was funded by INIA projects RTA2005-00219-C03-03 and RTA2009-00028-C03-02. Jon González-Torralba was predoctoral scholarship holder of the Public University of Navarre (Spain). The authors thank Guria S.A. (Vilafranca Group) for excellent technical assistance.

References

- Garrido-Lestache E., López-Bellido R.J. and López-Bellido L. 2004. Effect of N rate, timing and splitting and N type on bread-making quality in hard red spring wheat under rainfed Mediterranean conditions. *Field Crops Research* 85, 213-236.
- Johansson E., Prieto-Linde M.L. and Jönsson J.Ö. 2001. Effects of wheat cultivar and nitrogen application on storage protein composition and breadmaking quality. *Cereal Chemistry* 78, 19-25.

Effect of pretreatment on estimation of slurry composition by NIR spectroscopy with different probes

Finzi, A.^a, Oberti, R.^a, Negri, A.S.^b, Perazzolo, F.^a, Cocolo G.^a, Tambone, F.^b, Cabassi, G.^c, Provolo, G.^a

^a Università degli Studi di Milano, Department of Agricultural Engineering, Milano, Italy

^b Università degli Studi di Milano, Department of Plant Production, Milano, Italy

^c CRA-Agricultural Research Centre-Research Centre for Fodder Crops and Dairy Production (CRA-FLC), Lodi, Italy

1. Background & Objectives

In order to apply the correct rate of manure to minimize environmental risk and optimized crop production, farmers would benefit of a method to quickly determine in-situ manure nutrient concentrations (Millmier et al., 2000). NIR spectroscopy could satisfy this necessity as demonstrated by positive laboratory experiences in the analysis of livestock effluents. Studies showed the good predictive capability of models for parameters such as dry matter, total nitrogen and ammonia. Ye et al. (2005) report for different slurries R^2 between 0.80-0.97 and RPD (ratio of standard error of performance to standard deviation) higher than 3 for total solids (TS), volatile solid (VS), total nitrogen (Ntot), ammonia nitrogen ($\text{NH}_3\text{-N}$). Reeves and Van Kessel (2000) affirmed that the NIR spectroscopy is able to predict, for dairy manures, the contents of moisture, total C, total N and $\text{NH}_3\text{-N}$ with R^2 greater than 0.9.

The aim of this study is to evaluate the possible field use of this type of analysis, trying to identify the factors to be controlled in order to obtain accurate and reproducible values of Ntot and NH_4 contained in slurry, while seeking to develop a user-friendly technology. Therefore, we were interested in figuring out how different pre-treatments and probes are related with the capability of prediction on Ntot and NH_4 amount, determined with NIR technology, in the dairy and swine slurry in order to individuate reliable experimental conditions.

2. Materials & Methods

We used 23 samples of livestock slurries taken from dairy and swine farms. After collection, each sample was divided into three subsamples. The first subsample was not treated (raw slurry), the second was homogenized (50-100 μm) with a homogenizer (Ultra Turrax IKA® T18™) and the third was filtered with 1 mm mesh filter. The NIR spectroscope (NIR Buchi Flex-N-500) adopts the technology of interferometer and Fourier transform. This instrument makes lectures in the spectral range between 1000-2500 nm with a resolution of 2 nm and 32 scans per spectrum. The NIR analysis was performed on the same day of lab analysis on the samples stored at +4°C. Each analysis was carried out with two different settings of NIR spectroscope, and that is with the petri and the optical fiber probe. For each experimental condition 3 spectra were acquired. A total of 18 spectra for each sample had thus been obtained (3 subsample x 2 probes x 3 replicates). The spectra obtained were processed with CAMO Unscrambler 9.7. The Partial Least Squares (PLS) regression was performed by setting categorical variables (treatment, probe, slurry) to correlate the spectra with the contents of Ntot and NH_4 . The PLS was assessed both in calibration and cross-validation using the uncertainty test and considering 20 Latent Variables. The PLS was performed by dividing the spectra into subgroups according to different treatments (raw, homogenized, filtered) and, alternatively, to the probes by which the reading was carried out (optical fiber and petri). In the experimental plan defined, to identify the best experimental condition to predict the content of Ntot and NH_4 , R^2 , RMSECV (Root Mean Square Error in Cross validation) and RPD were considered in order to evaluate the PLS models in cross-validation of NIR spectra (Jacobi et al., 2011).

3. Results & Discussion

In table 1 the main results of PLS analysis are reported. In general, RPD and R^2 values belonging to dairy slurry are lower and RMSECV are higher than those relating to swine slurry: we can assume that the analysis conducted on cattles referred on a more complex substrate. Prediction of Ntot in dairy slurry is better with petri than fiber, while filtered is the worst pre-treatments when petri is used. In swine slurry the better pre-treatment is filtration but the differences with homogenized and raw are limited. The results for the probes are similar.

Prediction of NH_4 in dairy slurry achieves good results with all pre-treatment and the fiber-filtered seems to be the best combination. In swine slurry R^2 and RPD of the probes for homogenized and filtered are all similar and achieve high values.

Table 1. PLS models for Ntot and NH_4

	Ntot						NH_4					
	Dairy slurry			Swine slurry			Dairy slurry			Swine slurry		
	RMSECV	R^2	RPD	RMSECV	R^2	RPD	RMSECV	R^2	RPD	RMSECV	R^2	RPD
Raw – Fiber	0.32	0.54	1.48	0.69	0.89	3.06	0.21	0.46	1.45	0.28	0.90	3.41
Raw – Petri	0.12	0.94	3.94	0.59	0.92	3.58	0.09	0.90	3.37	0.36	0.83	2.66
Homogenized – Fiber	0.22	0.75	2.31	0.63	0.92	3.50	0.14	0.77	2.16	0.26	0.92	3.68
Homogenized – Petri	0.12	0.92	4.24	0.6	0.92	3.68	0.09	0.91	3.36	0.21	0.95	4.55
Filtered – Fiber	0.36	0.62	1.74	0.50	0.94	4.31	0.07	0.94	4.16	0.22	0.95	4.78
Filtered – Petri	0.27	0.77	2.32	0.51	0.94	4.27	0.08	0.92	3.64	0.23	0.95	4.57

4. Conclusion

From the results emerged that the samples may benefit of a pre-treatment prior NIR analysis, because both filtered and homogenized slurry generally showed higher RPD and R^2 values. It is possible that the presence of high-size particles of raw slurry hinders the optical path. Results do not show great differences between R^2 and RPD for petri and fiber measurements.

Therefore, for a practical use of NIR for the prediction of nutrient content of slurry, it might be advisable to use a filtration in order to remove coarse particles while homogenisation does not seem useful. Optical fiber use can be a more practical solution for field measurement without affecting significantly the accuracy of prediction.

Acknowledgement:

Activity carried out in the framework of the Project Biogesteca (“Piattaforma di biotecnologie verdi e di tecniche gestionali per un sistema agricolo ad elevata sostenibilità ambientale” di cui all'accordo istituzionale sottoscritto il 15/3/2011 e repertoriato il 21/3/2011 al n. 15083/RCC), granted by Lombardy Region

References

- Ye, W., Lorimor, J.C., Hurburgh, C., Zhang, H. and Hattey, J. 2005. Application of near-infrared reflectance spectroscopy for determination of nutrient contents in liquid and solid manures. *Transaction of the ASAE* 48(5), 1911-1918.
- Jacobi, H.F., Moschner, C.R. and Hartung, E. 2011. Use of near infrared spectroscopy in online-monitoring of feeding substrate quality in anaerobic digestion. *Bioresource Tecnology* 102, 4688-4696.
- Millmier, A., Lorimor, J., Hurburgh, C., Fulhage, C., Hattey, J. and Zhang, H. 2000. Near-infrared sensing of manure nutrients. *Transaction of the ASAE* 43(4), 903-908.
- Reeves, J.B. and Van Kessel, J.S. 2000. Near-infrared spectroscopic determination of carbon, total nitrogen, and ammonium-N in dairy manures. 83, 1829-1836.

Enhanced biological nitrogen fixation in grassland swards for soil Nitrogen management

G. McCollum^a, D. Nelson^a, and J.R Rao^{a,b}

^aAgri Food and Biosciences Institute Northern Ireland (AFBINI), Newforge Lane, Belfast BT9 5PX.

^bUniversity of Ulster, Coleraine, Co. L'derry, BT52 1SA UK.

1. Background & Objectives

EU/UK/NI Nutrient Directives (e.g. Anon, 2007) outline stringent control on nitrogen fertiliser usage and supports the worldwide research seeking alternative 'biological solutions' (using microbial inoculants - plant growth promoting rhizobacteria or PGPR) for soil and crop nutrient management. The contribution of Biological Nitrogen Fixation (BNF) from legumes to primary agricultural production is desirable (e.g. Damoglou, and Cooper, 1985; Nelson, 2004) on account of its highly efficient, cost-free capture of the nutrient as opposed to using chemical fertiliser inputs and the absence of direct nitrogen leakage to the environment. However, delivering the 'best fit' local *Rhizobium* as biofertilisers for local clover varieties is a major challenge given the complexity of the host (clover), its selection of *Rhizobium* for effective symbiosis in a dynamic, harsh soil environment. Nevertheless *Rhizobium* as clover seed inoculants is desirable, and has not been fully explored for its potential in Ireland's crop management strategies. The prospects of developing seed inoculants may vastly improve by tapping into the existing knowledge accumulated upon seed versus effective rhizobia compatibility mechanisms. Taking cue from the findings that effective partnership for the successful symbioses is encrypted in the 'early dialogue' i.e. 'early nodulin' (*Enod*) protein encoding BNF gene expression (Cooper, 2007), in this study, we set out to capture snap shots of early nodulin (*Enod*) finger-prints of clover roots during early stages of bacterial infection and to explore its usefulness as a gene marker in clover seed-inoculant *Rhizobium* choices.

2. Materials & Methods

White clover (*Trifolium repens*) seedling roots were challenged with strains of *Rhizobium leguminosarum* bv *trifolii* with varying nitrogen-fixing efficiency. The putatively expressed proteins were initially separated on a gel electrophoresis from root hairs and were further purified via an anion exchange column perfusion chromatography (BioCad Sprint) system. We obtained snap shot proteomic data upon these presumptive early nodulins via MALDI-Tof mass spectra analyses and the protein sequences subjected to bioinformatic analyses in tandem with the available genomic data (reverse genetic expression analyses and micro-array genomic databases) comprising *Trifolium repens-Rhizobium* symbiosis.

3. Results & Discussion

The early nodulin (protein) profiles (Figure 1) of Dutch white clover challenged with effective N-fixing *Rhizobium* (gel lane 2-5) and the ineffective *Rhizobium* isolate (lane 6) together with infective but poor N-fixing isolates (lane 7, 8) and unchallenged (control, lane 9). Lane 1 and 10 were reserved for protein size markers) are seen with virtually with no early nodulin (*Enod*) protein finger prints in the size range expected. Figure 2 depicts the (MALDI-Tof) mass spectra analyses of early nodulin fractionated from the ion exchange column chromatography (BioCad sprint).

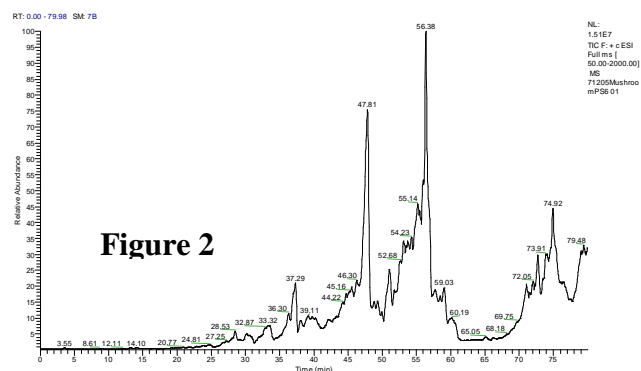
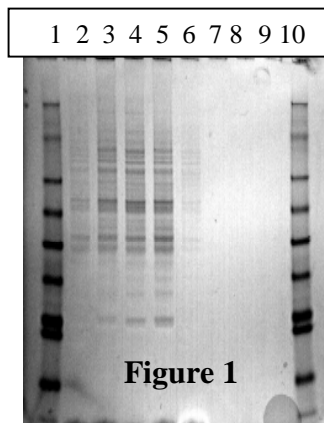

It was evident from the experimental results that the type of *Rhizobium* (effective, ineffective or infective but inefficient N-fixer) was recognized by the host plant in terms of the nodulin protein expressed. The clover root early nodulin (*Enod*) expressed by effective *Rhizobium* (lane 2-5) distinctly favors the most effective bacterium for symbioses whilst the *Enod* expressions are either faint for either ineffective *Rhizobium* (lane 6) or absent altogether in infective but poor N-fixer strains (lane 7, 8). The application of MALDI-Tof in our analyses has highlighted the importance of protein sequence's coherence of this early dialogue *Enod* gene expression. Upon closer dissection of the protein sequences, it revealed that a common signal peptide is shared by all full-length *Enods*, as is a highly conserved Proline-rich region. The high percentage of Alanine, Glycine, Proline and Serine residues, (see ion peak attenuations in Figure 2) found in the central backbone structure of *Enods* is characteristic of 'arabinogalactan' proteins.

It is perceivable from our proteomic study that the type of *Rhizobium* (effective, ineffective or infective but inefficient N-fixer) recognized by the host plant and the *Enod* protein expressed concurs with earlier extensive molecular genetic expression analyses at AFBINI (e.g. Crockard et al., 2001; 2002). The application of MALDI-Tof technique further corroborates the significance of the specificity seen in amino acid positions whose complementary *Enod* genetic codes were identified amongst the early cognizant signals between clover root and the compatible *Rhizobium*. Our results suggest that the characteristic 'arabinogalactan' responsive proteins in white clover challenged by 'effective' rhizobia could serve as a 'biomarker' for ensuring 'efficient' dialogue taking place between the plant and the bacteria for enhanced biological nitrogen fixation management.

Conclusion

Our study showed that the precise 'early nodulin protein motif' described herein can be considered as a biomarker for effective host (clover) selection of the type of *Rhizobium* it symbioses with; thus raising realistic prospects of utilizing this as a useful gene marker in clover seed-inoculant rhizobia choices. Our work also suggests that this protocol can be adaptable for selecting best performing free-living N-fixers (e.g. *Azospirillum*, *Azotobacter*) for grass. In the light of our findings, we recommend a twin-track strategy comprising clover and grass seed microbial inoculants technology development for suppressing chemical fertiliser dependency and for improving long-term N-management in Irish grassland swards.

References

- Anon. 2007. Balanced fertilisation to minimise total Nitrogen input *with fertiliser* (both bio manure and chemical fertiliser) to crop requirements. In EC Nitrates Directive (http://ec.europa.eu/environment/water/waternitrates/index_en.html)
- Crockard, M., Bjourson, A.J., Pulvirenti, M.G. and Cooper, J.E. 2001. Temporal and spatial expression analyses of TrEnod40, TrEnod5 and a novel early nodulin in white clover roots and nodules. *Plant Science* 161(6):1161-1170.
- Crockard, M., Bjourson, A.J., Dazzo, F.B. and Cooper, J.E. 2002. A white clover nodulin gene, dd23b, encoding a cysteine cluster protein, is expressed in roots during the very early stages of interaction with *Rhizobium leguminosarum* biovar *trifolii* and after treatment with chitolipooligosaccharide Nod factors. *Journal of Plant Research* 115(6):439-447.
- Cooper, J. E. 2007. Early interactions between legumes and rhizobia: disclosing complexity in a molecular dialogue. *J Appl Microbiology* 103 (5), 1355-1365.
- Damoglou, A. P. and Cooper, J. E. 1985. Microbial inoculants for legumes and silage - a case to be proved. *Agriculture in Northern Ireland* 59(12), 401-403.
- Nelson, L. M. 2004. Plant growth promoting rhizobacteria (PGPR): Prospects for new inoculants. Online. *Crop Management*. doi:10.1094/CM-2004-0301-05-RV.

Fertigation techniques to increase the nitrogen use efficiency of slurries

Mantovi, P.^a, Bortolazzo, E.^b, Battilani, A.^c

^aCRPA Foundation Studies and Researches, Reggio Emilia, Italy

^bResearch Centre on Animal Production – CRPA, Reggio Emilia, Italy

^cConsorzio di bonifica per il Canale Emiliano Romagnolo CER, Bologna, Italy

1. Background & Objectives

The clarified fraction of livestock slurries can be mixed with irrigation water to fertigate crops. New applications are being developed in different continents (Sun et al., 2011).

The solid/liquid separation of slurry concentrates ammonia nitrogen in the clarified fraction while most of the organic matter is removed as solid fraction. By using the clarified fraction, manure nitrogen use efficiency (NUE) is significantly improved compared to unprocessed slurry.

With the aim of improving the NUE of livestock slurries, trials were set up to distribute clarified fractions through fertigation systems on (i) drip fertigated maize (clarified fractions of digested pig slurry and digested cattle slurry), and on (ii) grassland fertigated using a reel machine equipped with boom (clarified fraction of digested cattle slurry).

2. Materials & Methods

The supernatant of anaerobically digested pig slurry, following settlement in a storage tank, was diluted with water at a 1:3 ratio (vol/vol) before injection into drip lines. The clarified fraction of anaerobically digested cattle slurry obtained from drum press separation treatment was applied through two different systems, a drip line and a sprinkler. Because of the higher suspended solids content, the cattle slurry clarified fraction needed to be diluted at a 1:10 ratio to be used with drip lines. The diluted clarified fractions were filtered before being injected into the drip irrigation system. Filtration intensity was optimised in order to reduce its cost; therefore a disc filter unit was utilised with pig slurry and a sand filter with cattle slurry. The physical and chemical characteristics of the clarified slurries utilised in fertigation, before and after dilution, are shown in table 1.

Table 1. Physical and chemical characteristics of the liquid fractions and diluted liquid fractions utilised to fertigate.

		Pig slurry (Drip)	Cattle slurry (Drip)	Cattle slurry (Sprinkler)	1:3 diluted pig slurry (Drip)	1:10 diluted cattle slurry (Drip)	1:10 diluted cattle slurry (Sprinkler)
pH	-	8.2	7.9	8.1	8.2	7.9	7.9
Dry Matter	%	0.95	1.35	3.1	0.31	0.19	0.3
Total Suspended Solids	g L ⁻¹	1.4	6.7	15	0.27	0.7	1.6
Total Kjeldahl Nitrogen	mg L ⁻¹	2160	1450	2692	627	141	262
Ammonia Nitrogen	mg L ⁻¹	2009	992	1855	540	96	165
Total Phosphorus	mg L ⁻¹	98	150	358	40	12	31

Traditional broadcast mineral fertilisation and organic fertilisation with untreated slurries distributed at the earlier maize growing stages have been compared with fertigation. In all treatments, drip lines were positioned between alternate maize rows.

Grassland was sprinkler irrigated and fertigated by a reel machine+boom. Sprinkler irrigation, even when small nozzles are used, is far less affected by clogging caused by the residual suspended solids of the cattle liquid fraction (than drip lines). Therefore, the clarified fraction of cattle slurry was directly injected into the fertigation system (diluted with water at a 1:10 ratio) without further filtration. Three grasslands in different forage crops rotations were fertigated.

To determine nitrate concentration, soil samples were taken to 50 cm depth, close to the drip lines

or within the sprinkler irrigated area. Ammonia emissions were also measured following the application of the pig slurry, using mini wind tunnels.

3. Results & Discussion

As expected, the high residual content of dry matter and total suspended solids in the clarified fraction of cattle slurry made drip fertigation management more difficult compared to the clarified fraction of pig slurry. Utilisation of diluted clarified fraction of pig slurry in the drip lines, with a dilution factor of three, was manageable and simple. Instead, although diluted at a 1:10 ratio, cattle slurry clogged the filter units when the total suspended solids concentration exceeded 8 g L⁻¹. Nevertheless, the drip irrigation system was not damaged and irrigation resumed after the filter was automatically backflushed. Sprinkler irrigation resulted more suitable than drip lines to fertigate with cattle slurry. In the fertigation trials NUE significantly increased compared to a reference system (band spreading of raw slurry between maize rows). This was particularly evident when maize was drip fertigated with diluted pig slurry, where higher N uptake was measured in comparison with the treatment based on raw slurry (Table 2). The fertigation treatment allowed better use of the natural soil fertility as shown by the negative input-output N balance.

Table 2. Nitrogen inputs and outputs for the two treatments (kg ha⁻¹)

	Fertigation	Band spreading
Input from mineral fertiliser before maize seeding	78	78
Input from slurry on growing crop	194	245
Output by maize uptake (aboveground vegetation)	290	247
<i>Inputs-Outputs</i>	-18	76

With respect to ammonia emission, drip fertigation resulted in significant benefits with a reduction of losses of more than 90% in case of pig slurry compared to the band spreading application.

In the fertigated trials nitrate concentration in soils increased after each fertigation and decreased afterwards because of crop uptake. To limit nitrogen leaching as much as possible and to improve the NUE it is of the utmost importance to decide fertigation timing and N supply on the basis of a water and nitrogen balance. Nitrogen application should not exceed plant need and should be performed when the soil water is not moving out of the rootzone. The Maximum Application Standards (MAS) rules, as defined in the Italian Action Programmes under the Nitrates Directive, must be fulfilled.

4. Conclusion

Different fertigation techniques offer the possibility to maximise slurry NUE. Therefore, they could help in improving the utilisation of manure nitrogen as a resource and reduce mineral N inputs. The drawbacks in the operational implementation of these systems are the need to set up slurry separation and distribution equipment, and the maintenance of the pumps and filters. Fertigation could be a method to improve and expand the period of manure application during the growing season. Results of these trials will be utilised to scale up the systems at demonstrative level in the LIFE+ AQUA Project coordinated by CRPA (<http://aqua.crpa.it>).

References

Sun Q., Li J., Liu B., Zou G. and Liu B. 2011. Study on biogas slurry drip fertigation technics. China Biogas, 3. http://en.cnki.com.cn/Article_en/CJFDTOTAL-ZGZQ201103007.htm

Online Farm Nutrient Management Calculators

Mathers, G.W.^a, Chisholm, E.J.^b, Browne, M.R.^c, McCarney, G.C.^d

^{a,d} CAFRE, Greenmount Campus, 45 Tirgracey Road, Antrim, BT41 4PS, N Ireland

^{b,c} AFBI, 18a Newforge Lane, Belfast, Antrim, BT9 5PX, N Ireland

1. Background & Objectives

In order to provide farmers with information to help them achieve the requirements of the Northern Ireland Nitrates Action Programme (NI NAP), various farm-management calculators have been developed and deployed over the Internet. This abstract describes two of these, namely – the Livestock Manure Nitrogen Loading Calculator, and the Crop Nutrient Recommendation Calculator. These calculators were developed jointly by two NI organisations - the Agri-Food & Biosciences Institute (AFBI) and the College of Agriculture, Food and Rural Enterprise (CAFRE). AFBI provided the software development expertise and scientific input, with CAFRE supplying the knowledge transfer with regards EU requirements and the practicality of the calculators. There will be an interactive software demonstration of both online applications.

2. Materials & Methods

Livestock Manure Nitrogen Loading Calculator

To comply with the NI NAP, farmers need to know if the livestock manure N loading of their farms is below 170 kg N ha⁻¹year⁻¹ limit, or if operating under derogation, whether it is under 250 kg N ha⁻¹year⁻¹ limit. This control is in effect a stocking rate limit which applies to both grazing and intensively farmed livestock. This calculator is an online tool to help farmers to manage their farm businesses to comply with the NI NAP. The calculator uses the following information to estimate farm N loading in addition to simultaneously calculating the livestock manure phosphorus for farmers operating under derogation:

- Area of Land Controlled (per ha): *Land owned, leased or let out*
- Livestock details: *Numbers and ages of different types of livestock*
- Amounts and types of manure/slurry exported and/or imported

Crop Nutrient Recommendation Calculator

This calculator estimates the amounts of nitrogen (N), phosphate (P₂O₅) and potash (K₂O) required by crops and thus helps farmers match the nutrient requirements of a crop to that supplied by organic manures and chemical fertilisers. It also assists farmers to comply with the nitrogen and phosphate limits contained within the NI NAP which has a specific requirement that all applications of chemical phosphate fertiliser should be supported by soil analysis and take into account phosphate supplied by livestock manures. In addition the calculator supplies essential information required for NI NAP record keeping for up to five years. The calculator uses the following information to produce a nutrient management plan:

- Soil analysis and previous cropping information
- Recommendations from both 7th & 8th Editions of RB209; standard figures from NI NAP

The farmer inserts information about the amounts and types of slurry and the amounts and types of fertilisers that he intends applying to each field. The calculator uses this information to calculate the total inputs of N, P₂O₅ and K₂O to each field and then shows any differences between these inputs and the amounts actually recommended by RB209. Based on the

differences shown, the farmer may then increase or decrease his manure or fertiliser inputs to obtain a better match.

3. Results & Discussion:

These calculators have proved to be invaluable farm-management tools, helping farmers comply with the NI NAP. Since launch in 2009, the number of unique online users of the Nitrogen Loading Calculator has increased from 418 to 638 in 2011; similarly; the number of users of the Crop Nutrient Recommendation Calculator has risen from 328 in 2009 to 408 in 2011.

4. Conclusion

This project has demonstrated successful knowledge transfer, bridging the gap between research and policy with practical application.

References

Ministry of Agriculture, Fisheries and Food 2000. Fertiliser recommendations for agricultural and horticultural crops (RB209), 7th edition, HMSO, London

Department for Environment, Food and Rural Affairs 2010. Fertiliser Manual (RB209), 8th edition, The Stationary Office, UK

Plant analytical tool for nitrogen N detection status in potato crop

Filipović, A.^a, Poljak, M.^b

^aFaculty of Agriculture and Food Technology, University of Mostar, Bosnia nad Herzegovina

^bFaculty of Agriculture, University of Zagreb, Croatia

1. Background & Objectives

Nitrogen is a vital nutrient that helps plants and crops to grow, but high concentrations are harmful to people and nature. Generally, farming remains responsible for over 50% of the total nitrogen discharge into surface waters. The 1991 Nitrates Directive is one of the earliest pieces of EU legislation aimed at controlling pollution and improving water quality. Determining potato N needs and predicting the fertilization rate for the duration of the growing season cannot be based only on soil tests. Many researchers have found SPAD (potato - Westcott et al., 1991, corn - Wood et al., 1992) and Cardy-ion meter readings (vegetable crops - Hochmuth, 1994) as reliable indicators of plant N status during the growing season. The objective of this paper is to estimate effectiveness of proposed tools in determining plant N status of the autochthonous potato variety Poluranka.

2. Materials & Methods

The indigenous potato variety Poluranka was planted in the mountainous area of Šćitar (Bosnia and Herzegovina) in 2009 at 1404 m.a.s.l. Half of the total annual fertilizer nitrogen was applied at pre-planting and other half before hilling, while standard doses of P₂O₅ (140 kg ha⁻¹) and K₂O (210 kg ha⁻¹) were applied at pre-planting according to the soil test. For basic fertilization NPK 7:20:30 were used while additional N was applied as urea and calcium ammonium nitrate. Five N rates were applied i.e. 0, 50, 100, 150 and 200 kg N ha⁻¹ in a randomized block design in three replicates. Measurement by Chlorophyll meter and Cardy-ion meter were performed on the uppermost, fully expanded mature leaf, which generally on the fourth or fifth node of stems below the top of the canopy. Measurements were made 65, 75, 85 and 95 DAS (days after sowing) on five plants per treatment. Total nitrogen concentrations in potato leaves were analyzed by the Kjeldahl method (AOAC, 1970). For statistical processing the dates GenStat 7 software (Laws Agricultural Trust, Rothamsted Experimental Station) were used.

3. Results & Discussion

Analysis of variance has shown that the measurements recorded by the two meters as well as laboratory measurement of N in potato leaves were strongly influenced by fertilization treatment and day of measurement (DAS) (Table 1) while interaction of the two factor influenced Cardy-ion (NO₃-N mg kg⁻¹) (Figure 1) and Chlorophyll readings (Figure 2).

Table 1. Analysis of variance for N, Chlorophyll and Cardy-ion readings affected by two factors (fertilization and DAS)

Variants	Source of variation		
	Fertilization treatments	DAS	Treatment × DAS
N (%)	**	**	ns
Chlorophyll readings	**	**	*
Cardy-ion readings NO ₃ -N (mg kg ⁻¹)	*	**	*

NS – non significant; *- significant (p<0.05); **-significant (p<0.01)

Nitrate-N declined with time. Cardy-ion meter readings were sensitive to plant N status resulting not only from differences in soil N availability but also environmental conditions, and possibly other factors.

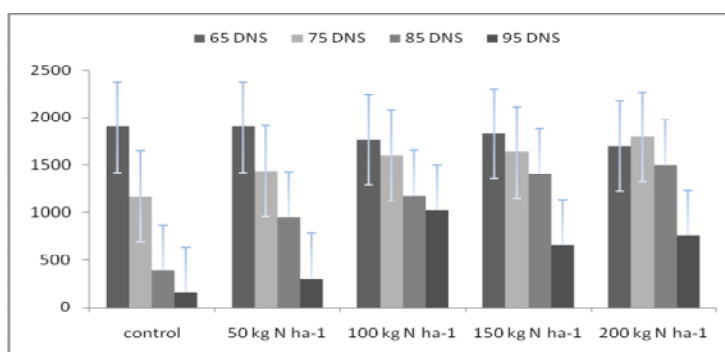

Figure 1. Distribution of NO₃-N values (mg kg⁻¹) measured on four sampling occasions under increasing fertilization rate. Bars show differences between treatment with LSD_{0,06}=478

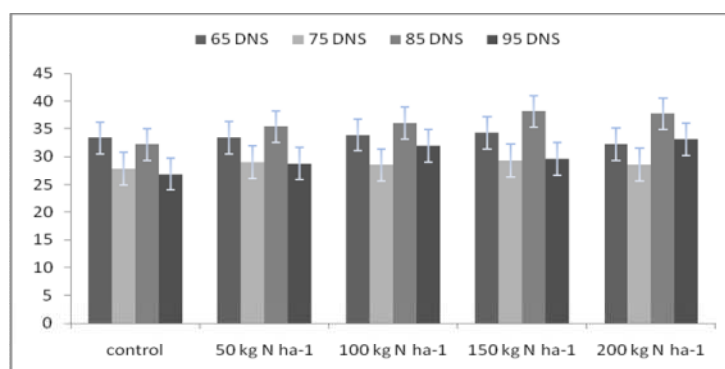

Figure 2. Distribution of Chlorophyll values measured on four sampling occasions under increasing fertilization rate. Bars show differences between treatment with LSD_{0,06}=2,89

Chlorophyll values increased slightly with higher fertilizer applications without significant differences and date of sampling has not provided linear collapse of values as vegetation ends. Chlorophyll meter was less sensitive to fertilization or date of sampling and values were probably reflection some other environmental factors what requires further investigation.

4. Conclusion

This work indicates that Cardy-ion meter readings show more sensitivity to N fertilization rate and follows values of N measured in leaves by laboratory method while chlorophyll readings were affected by some environmental conditions other than fertilization. Cardy ion meter is more reliable in detecting differences in nutrient tissue status for Poluranka potato cultivar then chlorophyll meter.

References

- Wescott, M.P. Stewart, V.R and Lund, R.E. 1991. Critical petiole nitrate levels in potato. *Agronomy Journal* 83, 844-850.
- Hochmuth, G.J. 1994. Efficiency ranges for nitrate-nitrogen and potassium for vegetable petiole sap quick tests. *HortTechnol* 4, 218-222.
- Wood, C. W., Reeves, D.W., Duffield, R.R and Edmisten, K.L. 1992. Field chlorophyll measurements for evaluation of corn nitrogen status. *Journal of Plant Nutrition* 15(4), 487-500.

Potential indicators based on leaf flavonoids content for the evaluation of potato crop nitrogen status

Ben Abdallah, F.^a, Goffart, J.P.^b

^aGembloux Agro-Bio Tech (GxABT), University of Liège, Gembloux, Belgium

^bThe Walloon Agricultural Research Centre (CRA-W) Gembloux, Belgium

1. Background & Objectives

Nitrogen (N) fertilization strategies for potato crops aim to limit environmental pollution by improving N use efficiency. Such strategies may use indicators for the assessment of crop N status (CNS). Leaf polyphenolic (flavonoid) content appears to be a valuable indicator of CNS (Cartelat et al., 2005; Tremblay et al., 2007). Because of their absorption features in the UV part of the spectrum polyphenolic compounds can be measured by rapid and non-destructive optical methods generating chlorophyll fluorescence (Cerovic et al., 2005). The objective of this research was to compare the use of leaf flavonoid content as a potential indicator for the evaluation of CNS with other recognized plant-based indicators such as chlorophyll content measured by transmittance or reflectance.

2. Materials & Methods

Trials were conducted in Belgium in 2010 and 2011 on two potato cultivars: Charlotte and Bintje. The experiments included five N rates for each cultivar in a completely randomized block design. Leaf flavonoid content was determined using two devices, the Dualex and Multiplex (Force-A, Paris, France). Leaf chlorophyll content was measured with a SPAD/HNT chlorophyll-meter (Yara, Oslo, Norway) and a Cropscan radiometer (Cropscan, Rochester, USA). The measurements were made periodically during potato growth from mid of June to the end of July. Results for 2010 are presented in this study (data for 2011 are still under investigation). The characteristics of the N-indicators studied here are presented in Table 1.

Table 1. Description of potential N indicators provided by optical sensors.

Optical sensors	Indicators	Signature	Related compound
Chlorophyll-meter	SPAD	Transmittance	Chlorophyll
Dualex	FLV	Fluorescence	Flavonoids
	NBI	Fluorescence-Transmittance	Chlorophyll-Flavonoids
Chlorophyll-meter and Dualex	SPAD/FLV	Fluorescence-Transmittance	Chlorophyll-Flavonoids

After measurements were completed in the field, plant tissue samples were collected for biomass N concentration and crop yield. Nitrogen content analyses allow the calculation of N Nutrition Index, a reference method for diagnosing CNS. Data were subjected to ANOVA and orthogonal contrast analyses of linear, quadratic, and residual effects for quantitative N treatments (SAS software). Indicator performance was evaluated on the basis of three criteria: specificity to N, stability of the measurements and earliness of the diagnosis. Accuracy and precision of the measurement were also investigated (data not shown).

3. Results & Discussion

The significant N effect and the absence of interaction between date of measurement and N rate, enable the selection of one indicator for each cultivar among 36 studied. The results summarized in Table 2 provide the application of the three criteria.

Table 2: Selected N-indicators according to statistical analyses.

Cultivars	Bintje	Charlotte
Criteria		
Specificity	N***	N***
Stability	N*DAE ^{NS}	N*DAE ^{NS}
Earliness of diagnosis	N**	N*
Selected indicators	SPAD/FLV	NBI

N: Nitrogen effect. N*DAE: interaction between nitrogen effect and date of measurements (Days After Emergence, DAE). *, ** and *** indicate statistical significance respectively at $P \leq 0.05$, $P \leq 0.01$ and $P \leq 0.001$. NS indicates no significance at $P > 0.05$.

Specificity and stability were assessed by consistency of response to N levels across all sampling dates and by the absence of interaction with the date of measurements. The response of the measured indicators was also studied for the first date of sampling (5 and 17 DAE, respectively, for Charlotte and Bintje) in order to assess early relevant CNS. SPAD/FLV (Bintje) and NBI (Charlotte) ratios were the indicators that combined best the three criteria.

4. Conclusions

Neither flavonoid nor chlorophyll content of the leaf, considered alone, was able to meet successfully all requirements. Results from use of the ratio of content of leaf flavonoid to leaf chlorophyll as SPAD/FLV or NBI suggest that these indicators could be used as valuable tools to assess potato CNS. This preliminary finding agrees with results of Tremblay et al. (2007), Cartelat et al. (2005) and Cerovic et al. (2005) and shows that these ratios improve the discrimination between N treatments. This effect is related to the inverse dependence of chlorophyll and flavonoids on CNS.

References

- Cartelat A., Cerovic, Z. G., Goulas, Y., Meyer, S., Lelarge, C., Prioul, J. L., Barbottin, A., Jeuffroy, M. H., Gata, P., Agati, G. and Moya, I. 2005. Optically assessed contents of leaf polyphenolics and chlorophyll as indicators of nitrogen deficiency in wheat (*Triticum aestivum* L.), *Field Crops Research* 91, 35–49.
- Cerovic, Z.G., Cartelat, A., Goulas, Y. and Meyer, S. 2005. In-field assessment of wheat-leaf polyphenolics using the new optical leaf-clip Dualex, In: Stafford J.V. (ed.), *Precision agriculture '05*, Wageningen pp.243
- Tremblay, N., Wang, Z. and Belec, C. 2007. Evaluation of the Dualex for the assessment of corn nitrogen status, *Journal of Plant Nutrition* 30, 1355-1369.

Quantitative evaluation of hot water extractable organic matter of organic farm soils in Japan by measurement of chemical oxygen demand with inexpensive chemicals and equipment

Kanazawa, K., Takahashi, S., Komada, M., Kato, N.

National Agriculture and Food Research Organization, National Agricultural Research Center, Tsukuba 305-8666, Japan

1. Background & Objectives

In response to the recent price increase of fertilizers, soil testing is being further promoted throughout Japan. As for nitrogen fertility, however, the national recommendation for available nitrogen is defined as the mineralized nitrogen during 4-week incubation (4WN), and is a less used index in soil fertility management, although it should better be considered especially in organic farming. Uezono and Kato (2012) have recently demonstrated that a far quicker and simpler method predicts 4WN fairly well. This method is a combination of hot water extraction of organic matter from soil and chemical oxygen demand (COD) measurement of the extracts, and it can be carried out without any special chemicals or equipment for laboratory use. Although it is quite promising method, for farmers to perform easily, measured values tend to be “semi-“quantitative because it is based on colour comparison with printed colour standards. The objective of this paper is to establish a quantitative still inexpensive method for COD measurement in the hot water extracts.

2. Materials & Methods

Soil samples were collected from 34 fields of 15 farms, used for mostly organic vegetable production, in Ishioka City, Japan. Air-dried soil samples were analysed for 4WN, total organic carbon (TOC) and COD in the hot water extracts (80°C 16h at soil/water ratio of 3 g/50 mL, (Uezono and Kato, 2012)). In the COD measurements, a commercially available set of chemical reagents (LR-COD-B, Kyoritsu Chemical-Check Lab., Corporation. 161JPY/test) and a LED type simple colorimeter (Checker HC series colorimeter/phosphate/HI 713, HANNA Instruments · Japan Corporation. 8,190JPY/set) were used instead of the COD measuring kit, reported by Uezono and Kato (2012). New COD measurement procedure is summarized in Figure 4.

3. Results & Discussion

(1) Using glucose solution as COD standards, the combined use of the set of chemical reagents and LED colorimeter was tested for measurement range, and was turned to be useful up to 10 mgO/L (theoretical oxygen demand basis, Figure 1). Working with the COD measuring kit, reported by Uezono and Kato (2012), evaluation would be carried out in 12 levels at most, because it depends on visual observation with log-scaled printed colour standards. Using this LED colorimeter, as shown in Figure 1, measured values would be valid between 2.50 to 0.80, which enables some 170 levels evaluation, because this equipment displays at resolution of 0.01. (2) Using hot water extracts from organic vegetable field samples, relationship between TOC and COD was examined, and a considerable correlation was observed (Figure 2). (3) Using hot water extracts from organic vegetable field samples, relationship between 4WN and COD was examined, and it was found that COD values predicted 4WN fairly well (Figure 3). TOC values also predicted 4WN, and there was no significant difference in correlation to 4WN between these two measurements. (4) New COD measurement procedure is summarized in figure 4. Proposed dilution ratio of 50 theoretically enables measurement up to 25mg N/100 g dry soil, which covers quite a wide range of fertility status.

For COD concentration between 0 - 10.5 ppmO
 $y = - 6.119x + 14.68$ ($R^2_{adj} = 0.9947$)

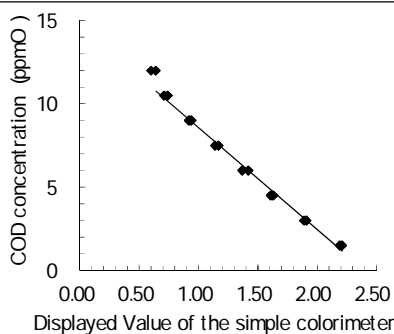

Figure 1. Measurement range of the proposed method for COD standards.

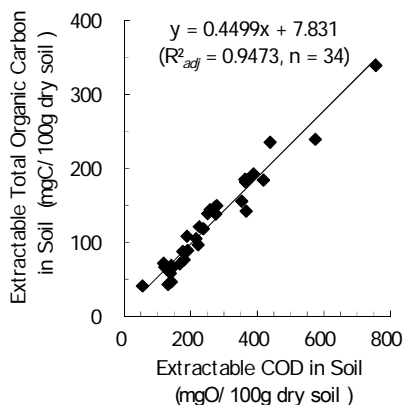

Figure 2. Relationship between extractable TOC and COD in soil.

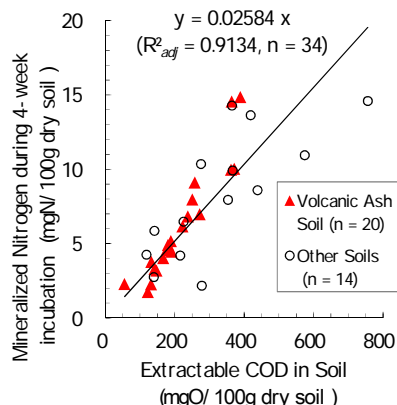

Figure 3. Relationship between available N and COD in soil.

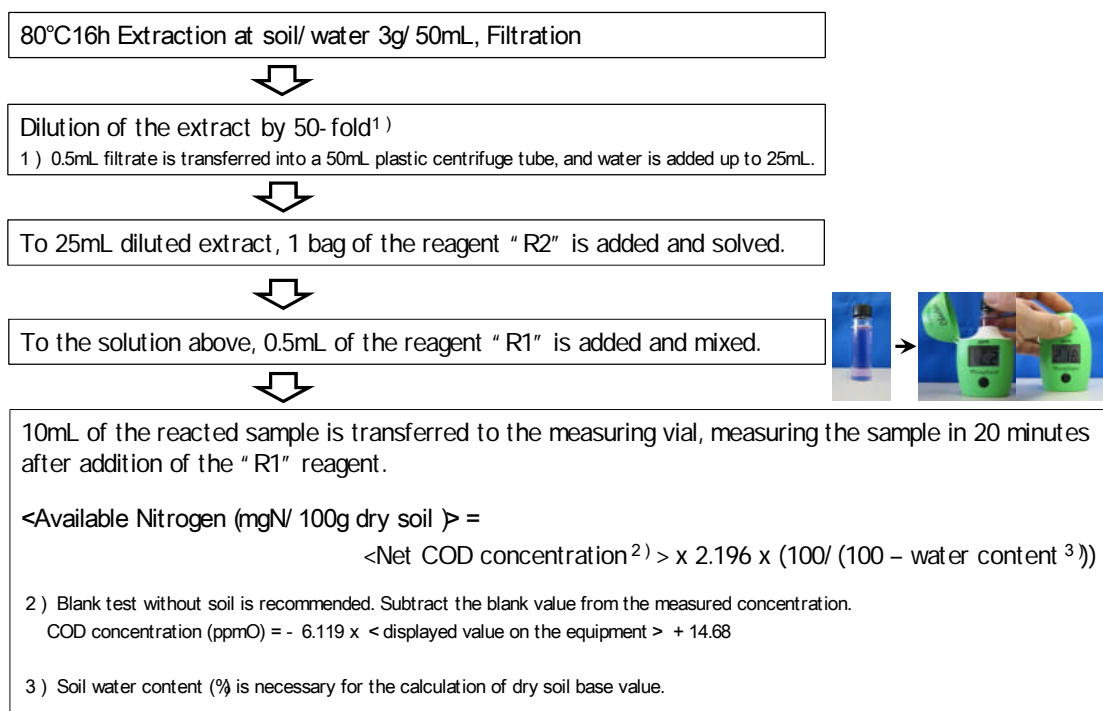

Figure 4. Proposed procedure for the estimation of available N using chemical reagent set and simple colorimeter.

4. Conclusion

This work presents a new method of the high resolution COD measurement, which promotes wider use of the recently developed simple assessment technique for nitrogen fertility by measuring hot water extractable organic matter in upland fields.

References

Uezono I. and Kato N. 2012. Rapid Evaluation of Available Nitrogen in Upland Soil by Hot Water Extraction and Measurement of Chemical Oxygen Demand. Bulletin of the Kagoshima Prefectural Institute for Agricultural Development, Agricultural Research 6, 49-58 (in Japanese with English summary)

Satellite data potential for assessing potato crop nitrogen status at a specific field scale

Goffart, J.P.^a, Van Den Wyngaert, L.^a, Buffet, D.^b, Léonard, A.^c, Defourny, P.^c

^aWalloon Agricultural Research Centre (CRA-W), Productions and Sectors Dpt, 5030 Gembloux, Belgium

^bWalloon Agricultural Research Centre (CRA-W), Agriculture and Natural Environment Dpt, 5030 Gembloux, Belgium

^cEarth and Life Institute – Environmental Sciences, Université Catholique de Louvain (UCL), 1348 Louvain-la-Neuve, Belgium

1. Background & Objectives

Enhancement of nitrogen use efficiency (NUE) is an important prerequisite in development of sustainable cropping systems. Production of crops, such as potato, that have a short period of N-uptake and a shallow rooting system is particularly influenced by low NUE. Several optically based and ground-based methods have been developed as tools to assess potato crop nitrogen status (CNS) (Hatfield et al., 2008) in order to improve the decision on the need for complementary N application (Goffart et al., 2008) and consequently NUE. The objective of this study was to explore the potential (sensitivity, specificity, and accuracy/precision) of large scale satellite multi-spectral (MS) image data for assessing CNS of potato compared to non-invasive ground-based data on leaf chlorophyll content obtained with a handheld chlorophyll meter (CM). This abstract presents the results of two years of trials conducted in Belgium, in potato field plots of variable sizes receiving a range of fertilizer N rates. Remotely sensed data from SPOT-5 satellite MS imagery (off-nadir) were also compared with handheld radiometer ground-based reflectance data (nadir view) for validation through several wavebands vegetation indices (VI) calculated according to literature references.

2. Materials & Methods

The study was conducted on 11 and 9 commercial potato crops in 2008 and 2009, respectively. In each field, plots of variable sizes received increasing fertilizer N rates (zero-N as reference plot, 70% and 100% of recommended N rate, except for 7 fields in 2008 that received only 100% N) were used to validate satellite images. Ground-based optical data with a CM SPAD/HNT (Yara, Oslo, Norway) and radiometer Cropscan (Cropscan, Rochester, USA) were obtained at intervals of 7-10 days from 20-75 DAE. Spot-5 satellite MS images were acquired on July 25, 2008 and August 5, 2009 when the potato crop was at the end of its vegetative stage between 55 and 75 days after emergence (DAE). The number of useful pixels of the MS images considered in each N plot varied from one pixel for the smallest plot in 2009 to about 30 pixels for the larger ones in 2008. Pixel digital number (DN) were extracted for each of three MS wavebands (green (G), red (R) and near infra-red (NIR)) using the ENVI image analysis software (version 4.3). To compare the satellite MS data with ground-based MS radiometer Cropscan (Cropscan, Rochester, USA) data, Top-of-Canopy (TOC) reflectance values were calculated from DN data extracted from the SPOT-5 satellite image in 2008. Different VI's were calculated from either satellite DN or ground-based radiometer data, and assessed for their sensitivity and accuracy/precision to discriminate between the different N plots, and for their specificity to CNS through their relationship to the biomass N content or N-uptake assessment in each N plot.

3. Results & Discussion

The comparison of TOC satellite data with ground-based reflectance measurements showed high coefficients of determination which is a good validation of the SPOT-5 data. Satellite data showed high sensitivity in discriminating the different N rates across a whole canopy, even taking into account a limited number of pixels. Significant discrimination was particularly obvious between the

reference zero-N plot and fertilized plots, as previously observed for CM readings (Olivier et al., 2006). Average DN data across pixels in the same N rate plot were affected by low coefficients of variation and small reference N plots (30 x 30 m) appeared to be an appropriate approach for collecting discriminating DN data. Average ground-based reflectance values show higher coefficients of variation compared with SPOT-5 DN data. An explanation could be that soil reflectance interferes more with canopy reflectance in ground-based measurements.

Among the different VIs considered, the GNDVI, GSAVI and GOSAVI (described in Table 1) acquired from SPOT-5 satellite MS reflectance data also have the potential for representing ground-based reflectance and discriminating the reference zero-N from the fertilized plots (Table 1). Such results are supported by recent findings (Bausch and Khosla, 2010). These VIs were also well correlated to the biomass N content or N-uptake assessed during the growing season.

SPOT-5 satellite MS imagery allows N to be monitored over a whole field or only small plots within the field. However, a major disadvantage revealed by this study was the limited availability of images within the required and short phenological period of the crop to perform CNS assessment. Bad weather conditions (cloud cover) hampered MS data acquisition in the visible and NIR wavebands, and also competition with other user's needs can limit real-time image availability.

Table 1. Average vegetation indices (GNDVI^a, GSAVI^b and GOSAVI^c with coefficients of variation in %) of reference zero-N and 70% N plots in four fields in 2008, calculated from Top-of-Canopy reflectance data extracted from pixels (n) of SPOT-5 satellite MS image acquired on July 25, 2008 (values belonging to the same field and followed by a different letter are significantly different at p>0.05)

N-plot	Field	n	GNDVI ^a	GSAVI ^b	GOSAVI ^c
Reference zero-N	1	15	0.623 a (3.37)	0.506 a (4.74)	0.490 a (4.08)
	2	15	0.717 a (1.95)	0.637 a (2.67)	0.587 a (2.21)
	3	26	0.713 a (1.00)	0.628 a (1.91)	0.582 a (1.37)
	4	24	0.646 a (2.01)	0.533 a (3.00)	0.512 a (2.34)
70% of N recommendation	1	11	0.683 b (2.05)	0.573 b (3.14)	0.546 b (4.91)
	2	15	0.757 b (0.50)	0.682 b (0.70)	0.624 b (0.50)
	3	31	0.746 b (0.40)	0.675 b (0.70)	0.616 b (0.50)
	4	14	0.704 b (2.00)	0.601 b (3.16)	0.567 b (2.47)

^aGreen Normalized Difference Vegetation Index = (NIR-G)/(NIR+G) ; NIR: near infra-red band, G: green band

^bGreen Soil Adjusted Vegetation Index = [(NIR-G)/NIR+G+0.5]*1.5

^cGreen Optimized Soil Adjusted Vegetation Index = (NIR-G)/(NIR+G+0.16)

4. Conclusion

This study indicates the potential of SPOT-5 (spatial and spectral resolution) to monitor potato CNS. The DN or derived VI data were accurate and showed high sensitivity to CNS even for small plot areas within a field. Operational use of such data acquisition in management strategy or decision support system for potato N fertilization at regional scale still needs to be explored further. Results should be confirmed with earlier acquisition dates within potato growing season.

References

- Bausch, W.C. and Khosla, R. 2010. QuickBird satellite versus ground-based multi-spectral data for estimating nitrogen status of irrigated maize. *Precision Agriculture* 11, 274-290.
- Goffart, J.P., Olivier M. and Frankinet M. 2008. Potato crop nitrogen status assessment to improve N fertilization management and efficiency : Past-Present-Future. *Potato Research* 51,355-383.
- Hatfield, J.L., Gitelson A.A., Schepers J.S. and Walthall C.L. 2008. Application of spectral remote sensing for agronomic decisions. *Agronomy Journal* 100, S117-S131.
- Olivier, M., Goffart J.P., Ledent J.F. 2006. Threshold values for chlorophyll meter as decision tool for nitrogen management of potato. *Agronomy Journal* 98, 496-506.

Sharing scientists' and stakeholders' knowledge in a DSS to reduce nitrogen losses in cropping systems

V. Parnaudeau^a, R. Reau^a, P. Dubrulle^a, C. Aubert^b, A. Baillet^c, N. Beaudoin^a, P. Béguin^{a*}, F. Butler^f, P. Cannavo^{a,j}, J.-P. Cohan^d, A. Dupont^a, R. Duval^e, S. Espagnolⁱ, J.P. Fagniez^a, F. Flénet^c, L. Fourrié^f, S. Générmont^a, L. Guichard^a, M.-H. Jeuffroy^a, E. Justes^a, F. Laurent^d, J.-M. Macheda^a, F. Maupas^e, T. Morvan^a, S. Pellerin^a, C. Raison^g, C. Raynal^h, S. Recous^a, J. Thiard^a

^a INRA, Département Environnement et Agronomie, * Département SAD, France;

^b ITAVI, France; ^c CETIOM, France; ^d ARVALIS-Institut du végétal, France; ^e ITB, France; ^f ACTA, France;

^g Institut de l'élevage, France; ^h CTIFL, France ; ⁱ IFIP, France; ^j Agrocampus-Ouest, France

1. Background & Objectives

Implementation of European Union (EU) Water Framework Directive (WFD, and more generally development of sustainable agriculture, require to reduce N losses (under gaseous or nitrate forms) and avoid pollution swapping in cropping systems. This relies on production system diagnosis and on design of innovative systems. In this context, one of the acute issues remains the improvement of nitrogen management, based on assessment and diagnosis of nitrogen use by the plant, N losses and impacts in agricultural systems. A Decision Support System (DSS), called Syst'N, has been developed, by sharing knowledge on N fluxes in agricultural systems between agricultural scientists and stakeholders. This DSS includes a dynamic nitrogen model to calculate N losses and a database gathering N loss results in different contexts; it is mainly intended for use by environmental managers and agricultural extension services.

2. Materials & Methods

The DSS requirements were determined from results of a survey (Parnaudeau et al. 2007). Following these specifications, different prototypes of the DSS interfaces were proposed and discussed between the designers, and finally proposed to a panel of potential users for their comments and remarks to improve our tool. This step in the concept required an inter-disciplinary approach combining ergonomic and agronomic sciences to organize our experimental design. In order to estimate, to understand, and to explain N losses as well as to diagnose N nutrition problems at the cropping system scale, it was necessary to describe the complete management of each crop in the rotation, and the soil and climate characteristics. Development of the DSS also included the choice and development of the dynamic N model. An exhaustive bibliographical analysis was performed to establish the state of the art concerning both N models and tools like DSS or indices to diagnose N losses (Cannavo et al., 2008). On this basis, we have integrated existing sub-models from the literature for our specific purpose, i.e. valid for a large range of agricultural, soil and climatic conditions. The selected sub-models were also chosen because of their reliability when used with available data from target users. Those choices involved several discussions between modellers, but the panel of potential users was not directly consulted for this modelling stage.

3. Results & Discussion

The interface for data entry includes default data, and enables the comparison of various cropping systems or the consideration of climatic uncertainties. In order to help users, default input databases propose the description of regional soils (three of the French ones in the prototype) and cropping systems. Each simulation folder describes the cropping system within its context, through a tree structure representation. The simulator calculates the different N losses: NO₃⁻ leaching, NH₃ volatilisation and N₂O losses by denitrification, especially to be able to evaluate pollution swapping when changing cultural techniques or cropping systems. The model runs in daily time steps, in

order to take account of gaseous losses as volatilisation. It integrates existing sub-models: soil organic matter and crop residue mineralisation is predicted by AZOFERT (Machet et al., 2004), denitrification is predicted by NOE model (Hénault et al., 2005), water balance and nitrate leaching are based on STICS model (Brisson et al., 1998, Brisson et al., 2009), and N uptake is based on AZODYN model (Jeuffroy et al., 1999). Some sub-models, i.e. manure mineralisation and volatilisation modules, were simplified by determining statistical relationships using a large dataset instead of developing mechanistic equations, to better take into account local soil and climatic conditions. The functional prototype of the software has to be tested and validated during the current year with external datasets. For crops, anticipated yield will likely need to be included as an input to improve prediction of crop growth and N uptake, in order to improve soil mineral N pool calculation in autumn and consequently N leaching (Makowski et al., 2009). Another step is the adaptation of the N model to cropping systems including grasslands or vegetable crops in order to make the tool more generic so that its use can be extended to various regions.

4. Conclusion

Simulation models need to be adapted to be useful to stakeholders as shown by Cox (1996) and MacCown (2002a, 2002b). We have built a DSS combining a user interface with a dynamic model, and proposed default data. We are going to continue designing and assessing the tool, by involving stakeholders in the improvement of the DSS through a learning loop. On this basis, we will develop a learning activity with stakeholders in order to improve assessment of N losses and to enable the use of simulation and virtual experimentation.

References

- Brisson, N., Mary, B., Ripoche, D., Jeuffroy, M.-H., Ruget, F., Nicoullaud, B., Gate, P., Devienne-Barret, F., Antonioletti, R., Durr, C., Richard, G., Beaudoin, N., Recous, S., Tayot, X., Plenet, D., Cellier, P., Machet, J.M., Meynard, J.M. and Delecolle, R. 1998. STICS: a generic model for the simulation of crops and their water and nitrogen balances. I. Theory and parameterization applied to wheat and corn. *Agronomie* 18, 311-346.
- Brisson N., Launay M., Mary B. and Beaudoin N. 2008. Conceptual basis, formalisations and parameterization of the STICS crop model. Editions Quæ, Paris, France.
- Cannavo, P., Recous, S., Parnaudeau, V. and Reau, R. 2008. Modeling N dynamics to assess environmental impacts of cropped soils. *Advances in Agronomy* 97, 131-174.
- Cox P.G. 1996. Some issues in the design of agricultural decision support systems. *Agricultural systems* 52, 355-381.
- Hénault C., Bizouard F., Laville P., Gabrielle B., Nicoullaud B., Germon J.C. and Cellier P. 2005. Predicting in situ soil N₂O emission using NOE algorithm and soil database. *Global Change Biology* 11, 115-127.
- Jeuffroy M.H. and Recous S. 1999. Azodyn: a simple model simulating the date of nitrogen deficiency for decision support in wheat fertilization. *European Journal of Agronomy* 10, 129-144.
- Machet, J.M., Recous, S., Jeuffroy, M.H., Mary, B., Nicolardot, B. and Parnaudeau, V. 2004. A dynamic version of the predictive balance sheet method for fertiliser N advice. *Controlling Nitrogen Flos and Losses, Inst Grassland & Environm Res*, 191-193.
- Makowski, D., Tichit, M., Guichard, L., Van Keulen, H. and Beaudoin, N. 2009. Measuring the accuracy of agro-environmental indicators. *Journal of Environmental Management* 90, Supplement 2, 139-146.
- McCown, R.L. 2002a. Locating agricultural decision support systems in the troubled past and socio-technical complexity of 'models for management. *Agricultural systems* 74, 179-220.
- McCown, R.L. 2002b. Changing systems for supporting farmers' decisions: problems, paradigms, and prospects. *Agricultural systems* 74, 179-220.
- Parnaudeau, V., Reau, R., Duval, R., Fourrié, L., Gillet, J.P., Guichard, L., Justes, E., Laurent, F., Machet, J.M., Maupas, F., Morvan, T. and Raynal, C. 2007. A sociological approach to determine the advisers and stakeholders requirements for nitrogen management and diagnosis tools. 15th European N workshop, Lleida.

Soil quality as affected by organic and mineral N fertilization in maize

Biau, A.^a, Mijangos, I.^b, Lloveras, J.^c

^aUniversity of Lleida (UdL), Av. Rovira Roure 191, Lleida 25198, Spain.

^bDepartment of Ecosystems, NEIKER-Tecnalia, Basque Institute of Agricultural Research and Development, c/Berreaga 1, E-48160 Derio, Spain.

^cCentre UdL-IRTA, University of Lleida (UdL), Av. Rovira Roure 191, Lleida 25198, Spain.

1. Background & Objectives

Pig slurry is considered an important potential source of nitrogen (N) in the Ebro Valley areas (Daudén and Quílez, 2004), where soils are often relatively low in organic matter (OM) (frequently < 2%) (Ferrer and Sanz, 1983). Manure applications may help to enhance soil fertility, to maintain soil quality (Brechtin and McDonald, 1994) and to improve soil structure with the increase of OM (Berenguer et al., 2008). The objective of this study was to evaluate the effect of long term organic and mineral N fertilization on selected soil quality indicators in continuous maize under irrigation.

2. Materials & Methods

Field experiments were conducted from 2002 to 2010 under sprinkler irrigation. Fertilization treatments consisted on pig slurry (PS) application and a mineral N fertilization applied as ammonium nitrate (33.5%) as a sidedress. A zero N rate was also studied as a control (N0). Annual PS application rate was about 50 m³ ha⁻¹ (PS50) (290 kg N ha⁻¹) and mineral N fertilization rate was 300 kg N ha⁻¹ (N300). Grain yield, biomass at maturity, plant N uptake and soil NO₃⁻-N were measured before and after harvest. Earthworms' abundance, soil compaction and OM were used as soil quality parameters.

3. Results & Discussion

Average grain yield from 2002 to 2010 responded differently ($p < 0.05$) to the source of N (Table 1). Nitrogen fertilization at 300 kg N ha⁻¹ had the highest grain yield. We think that this result was mainly due to the N volatilization losses of the PS50 (20% approximately) during the spreading of the slurry and also to the different N application times. The PS was applied before planting, whereas the N300 was applied as a sidedress. It is known that the sidedress N is more efficient than the pre-planting applications. Furthermore, part of the N applied with PS was possibly immobilized in the soil as organic forms, and can be released over a period of many years (Schröder, 2005).

Biomass production did not show differences between treatments, possibly because the amount of N in the soil was enough (Table 1). Nitrogen uptake significantly increased with the application of N fertilization compared with N0 over the years (Table 1). Our results were in line with those reported by Andrade et al. (1996) whose plant N content ranged from 240-300 kg N ha⁻¹. Residual soil NO₃⁻-N content at the end of the trail was higher with mineral than organic fertilization (Table 1), probably, as it was said before, because the higher amount of N really applied, and the higher N efficiency of the N300 treatment.

Pig slurry applications produced higher soil quality values, compared to N300 and N0 (Table 2). So, the results seem to indicate that long term organic fertilization improves soil quality in our conditions.

Table 1. Effect of N fertilization rates on grain yield, biomass at maturity, plant N uptake, soil NO₃-N content before planting (initial) and after harvest (residual), from 2002 to 2010 in Gimenezs.†

Treatments	Grain yield (Mg ha ⁻¹)	Biomass maturity (Mg ha ⁻¹)	Plant N uptake (kg ha ⁻¹)	Soil initial NO ₃ -N (kg ha ⁻¹) (2002)	Soil residual NO ₃ -N (kg ha ⁻¹) (2010)
2002-2010					
N0	7.3±3c†	17.6±6b	148±60c	290	59±7b
N300	14.3±1a	27.2±3a	294±66a	"	164±96a
PS50	12.8±2b	26±3a	252±68b	"	71±16a
Treatment	**	**	**	-	*

Mean values ± S.E. (n=3).

†Values in each column followed by the same letter are not significantly different at the 0.05 probability level

NS: not significant

*Significant at the 0,05 level

**Significant at the 0,01 level

Pig slurry applications increased the soil OM content in the experiment, as it was shown by Berenguer et al. (2008), and consequently it can affect soil compaction (Table 2). Earthworm abundance presented higher values in PS than in the other N fertilization treatments (Table 2). As Pankhurst et al. (1997) reported earthworms' abundance could provide a more sensitive bioindicator of soil quality than physic-chemical parameters such as OM content.

Table 2. Effect of N fertilization rate on physical, chemical and biological soil quality indicators in 2010 in Gimenezs.†

2010	Treatment	0-10 Compaction (Kpa)	11-20 Compaction (Kpa)	21-50 Compaction (Kpa)	OM (%)	Earthworms (ind m ⁻²)
	N0	2439a	2697a	3752a	2.40a	1b
	N300	1973a	2801a	4200a	2.94a	4ab
	PS50	1808a	2516a	3751a	2.96a	11a
Treatment		NS	NS	NS	NS	*

Mean values ± S.E. (n=3).

†Values in each column followed by the same letter are not significantly different at the 0.05 probability level

NS: not significant

*Significant at the 0,05 level

4. Conclusion

Long term organic fertilization with PS shows a slight improvement in soil compaction and OM. Furthermore, earthworms' abundance was clearly different among treatments and it can contribute to soil quality improvement under irrigated conditions. Therefore, we interpret PS applications as a good management procedure.

References

- Andrade, F.H., H.E. Echeverría, N.S. González and Uhart, S.A. and Darwich, N.A. 1996. Requerimientos de nitrógeno y fósforo de los cultivos de maíz, girasol y soja. EEA INTA Balcarce. Buenos Aires. Boletín Técnico 134, 1-17.
- Berenguer, P., S. Cela, F. Santiveri, J. Boixadera and J. Lloveras. 2008. Copper and zinc soil accumulation and plant concentration in irrigated maize fertilized with liquid swine manure. *Agron. J.* 100, 1056-1061.
- Brechin, J. and G.K. McDonald. 1994. Effect of form and rate of pig manure on the growth, nutrient uptake and yield of barley (cv. galleon). *Aust. J. Exp. Agric.* 34, 505-510.
- Daudén, A. and D. Quílez. 2004. Pig slurry versus mineral fertilization on corn yield and nitrate leaching in a mediterranean irrigated environment. *Eur. J. Agron.* 21, 7-19.
- Ferrer, P.J. and J.B. Sanz. 1983. Posibilidades de utilización agrícola del estiércol líquido porcino (ELP) en relación a su valor fertilizante su incidencia sobre el suelo. composición y valor fertilizante del ELP. *Anales INIA, Serie Agrícola* 23:35-57.
- Pankhurst, C., B. Doube and V. Gupta. 1997. Biological indicators of soil health. CAB INTERNATIONAL, .
- Schröder, J. 2005. Revisiting the agronomic benefits of manure: A correct assessment and exploitation of its fertilizer value spares the environment. *Bioresour. Technol.* 96, 253-261.

The rice crop response to pig slurry fertilization in Ebro Delta area (Catalonia, Spain): four seasons studied (2008-2011).

Català, M.M.^a, Pla, E.^a, Martínez, M.^{a,b}, Tomàs, N.^a

^aIRTA. Research & Technology Food & agriculture. Amposta. Ctra. Balada, km 1. 43870. Amposta. Spain

^bPresent address: Department of Agriculture, University of Reading, Earley Gate, Reading RG6 6AR, UK

1. Background & Objectives

Catalonia is the first Spanish region in the national register of pigs (26.3% of the national register) (MARM, 2010) with a census higher than 25 millions. The use of pig slurry (PS) as fertilizer is the most common recycling methodology.

The world energetic crisis and the increasing costs of chemical fertilizer have encouraged the interest for the use of farmyard manure (Meelu and Morris, 1987) which can guarantee a larger amount of macro and micronutrients (Mn, Cu, Zn and Fe) with lower cost (Hesse, 1984). Furthermore, it improves the physical properties of the soil and represents an environmental friendly agronomic practice. As a consequence, these economic, agronomic and environmental advantages have encouraged the launch of actions involved in the promotion and diffusion of good agricultural practices, such as the proper management of cattle droppings in order to prevent water sources from nitrates pollution. This paper aims at assessing the response of rice crop to the fertilization with pig slurry and at establishing criteria for the dosage.

2. Materials & Methods

The experimental site was located in a 2 ha-plot, in Ebro Delta rice field area, located on South-east of Catalonia (Spain) (40°43'58" N, 0° 45'56" E, at 0 meters above sea level). The medium-term organic and chemical fertilization field experiment was established in 2007; where only mineral fertilisation had been previously used. The experimental design was laid out with a split-block with three replicates, in which the main plot and subplot were the basal and top dressing fertilization, respectively. The area main plot area was 780 m² and the subplots were 390 m². Rice variety was Gleva, widely grown in Ebro Delta rice fields, at a seeding rate of 182 kg seeds ha⁻¹. Agronomic practices were identical to local management practices by commercial rice farmers.

The basal fertilization treatments were as follows: control (no basal fertilization), mineral fertilization (120 Kg N ha⁻¹ as ammonium sulphate at 21% N), low rate of PS (90 Kg N ha⁻¹), medium rate of PS (130 Kg N ha⁻¹) and high rate of PS (170 Kg N ha⁻¹). Top dressing fertilization (40 Kg N ha⁻¹) with ammonium sulphate at panicle initiation was compared with the no fertilizer application. Paddy soil properties before experiment initiation were as follows: pH: 8.2, organic matter: 4.0 %, USDA classification: silty clay. The annual average temperature is 18°C. The pig slurry was previously analyzed to determine the N, P₂O₅ and K₂O content (Table 1).

Table 1. N-P-K contents in pig manure used in the essay (Kg m⁻³).

Year	N	P ₂ O ₅	K ₂ O
2008	1,78	1,34	1,20
2009	1,80	0,25	1,31
2010	1,46	0,17	1,43
2011	1,81	0,98	1,39

3. Results & Discussion

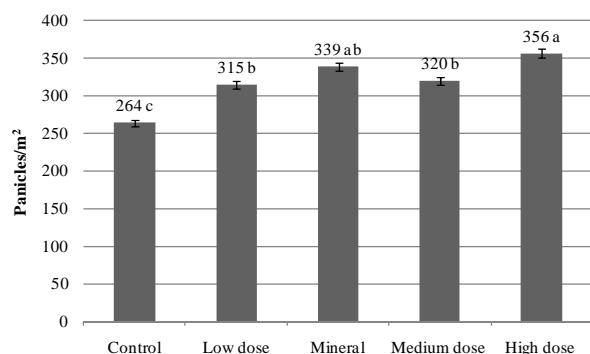

Figure 1. Panicle density in the basal fertilization treatments. The values shown are the average of the four year period (2008-2011)

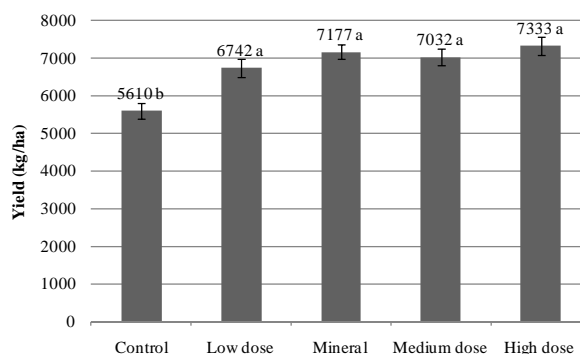

Figure 2. Yield in the basal fertilization treatments. The values shown are the average of the four year period (2008-2011)

The highest panicle density was obtained to the high dose of pig slurry with no difference respect to the mineral fertilization dose (Figure 1). The significant differences in yield were only observed between the control and the rest of basal fertilization treatments (Figure 2) which provided similar values. There was a positive response to increase the dose of N. The pig manure fertilization has not affected any studied treatments to the seedling establishment, development of pests and diseases or at weeds infestation (data no presented). The yield was increased 7% in plots with top dressing application (40 Kg ha⁻¹) significantly.

4. Conclusion

There is a good agronomic response of rice crop to pig slurry fertilization. The doses between 130-170 kg N ha⁻¹ are recommended. Pig slurry fertilization no influence on seedling establishment, disease sensitivity, nutritional status, weeds infestation and yield.

References

- Hesse, P.R. 1984. Potential of organic materials for soil improvement. In organic matter and rice. IRRI. Los Baños, Laguna, Philippines. 35-42.
- Ministerio de Medio Ambiente y Medio Rural y Marino. <<http://www.marm.es>>
- Meelu, O.P. and Morris, R.A. 1987. Integrated management of green manure, farmyard manure, and inorganic nitrogen fertilizers in rice and rice-based cropping sequences. In Efficiency of nitrogen fertilizers for rice. IRRI. Los Baños, Laguna, Philippines. 185-193.

Using canopy reflectance to determine appropriate rate of topdress N in potatoes

Van Evert, F.K.^a, Van der Schans, D.A.^b, Malda, J.T.^c, Van den Berg, W.^b, Van Geel, W.C.A.^b, Jukema, J.N.^b

^aPlant Research International, Wageningen University and Research Centre, Wageningen, The Netherlands

^bApplied Plant Research, Wageningen University and Research Centre, Wageningen, The Netherlands

^cALTIC, Dronten, The Netherlands

1. Background & Objectives

Potato (*Solanum tuberosum* L.) growing contributes significantly to nitrate pollution of groundwater in The Netherlands. It has been shown that N savings of 25-30 kg N ha⁻¹ without a negative effect on yield can be achieved by using a low basal N rate followed by a sidedress N application based on a measurement of canopy reflectance (Booij and Uenk, 2004; Van Evert et al., 2010). This method has been developed for cv. Bintje on a sandy soil, but in order to be of practical use, the method needs to work with a variety of soils and cultivars, and with the various sensors that farmers have at their disposal. The objective of the work reported here was to extend the reflectance-based N sidedress system to different cultivars, different potato use types (ware, starch, seed), different soils, and assess the usefulness of three different sensors.

2. Materials & Methods

Experiments were established in several locations in The Netherlands in 2010 and 2011. They comprised sand and clay soils; ware, starch and seed potatoes; and several cultivars. In all experiments, reflectance measurements were made with the CropScan (CropScan Inc., Rochester MN, USA) and the Weighted Difference Vegetation Index (WDVI; Clevers, 1989) was calculated; in one experiment, additional reflectance measurements were made with the N-Sensor (Yara International ASA, Oslo, Norway), Greenseeker (Trimble Inc. Denver, CO, USA) and CropCircle (Holland Scientific Inc., Lincoln NE, USA). Fresh tuber weight and dry matter content were determined at harvest in all experiments, while N uptake was determined through destructive sampling in some. Response curves were fitted where the data allowed and N_{opt}, the N rate at which maximum yield would have been obtained, was determined.

3. Results & Discussion

The relationship between WDVI and N uptake is shown in Figure 1. Symbols represent measurements throughout the season in the various experiments. The broken line represents the relationship that was developed in earlier work for cv. Bintje on a sandy soil. Statistical analysis showed that inclusion of soil type, cultivar or potato use type, did not improve the regression.

The N rate in the reflectance-based N sidedress system was in most cases closer to N_{opt} than either the recommended N rate or the N rate in a petiole nitrate-based sidedress system. The sign and magnitude of the difference between N_{opt} and the reflectance-based N rate was variable. In particular, when N_{opt} was higher than the recommended N rate, this was not adequately detected by the reflectance-based system.

In one experiment, N uptake at the time of sidedress (first week of July) was low and largely unaffected by basal N rate. There was no response to sidedress N. It seems that N uptake had been hampered by dry conditions in June, leading to pooling of soil mineral N. Rain in July allowed rapid uptake of soil mineral N and made sidedress N superfluous. This highlights a serious limitation of reflectance-based systems: they are unable to measure the status of the soil. Including a

measurement of soil mineral N would overcome this limitation, but is unattractive from the point of view of cost and the labour this involves.

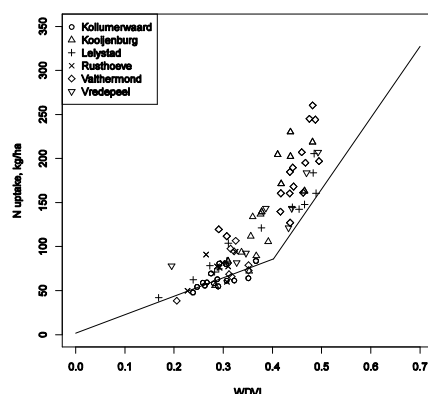

Figure 1. Relationship between WDWI and N uptake in potato. See main text for further explanation.

The relationship between N uptake and sensor-specific vegetation index for several sensors is shown in Figure 2. The NDVI measured with Greenseeker turned out to be a poor predictor of N uptake; NDVI measured with Cropcircle is a better predictor. The vegetation index S1 measured with the N-Sensor is as good a predictor of N uptake as the WDWI measured with Cropscan.

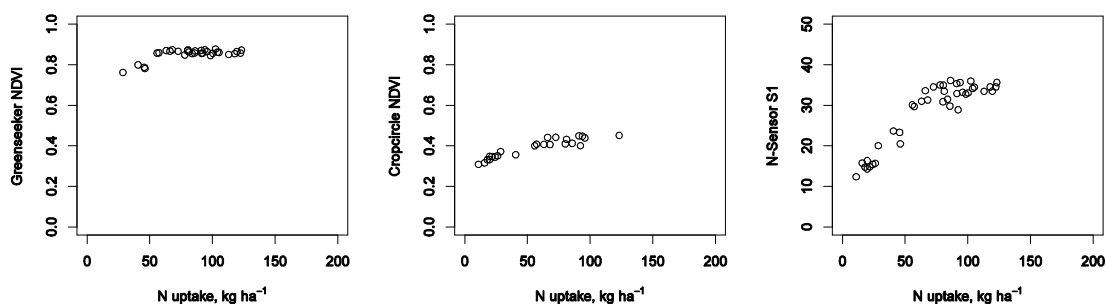

Figure 2. Relationship between aboveground N uptake and vegetation index measured with (from left to right) Greenseeker, Cropcircle and N-Sensor.

4. Conclusion

For a reflectance-based N sidedress system which allows N savings of 25-30 kg N ha⁻¹ without a negative impact on yield, the relationship between vegetation index and N uptake is not affected by soil, potato use type, or cultivar. Not all sensors discriminate potato N status equally well.

References

- Booij, R. and Uenk, D. 2004. Crop-reflection-based DSS for supplemental nitrogen dressings in potato production, in: D. Mackerron, and A. J. Haverkort (Eds.), Decision support systems in potato production: bringing models to practice., Wageningen Academic Publishers. pp. 46-53.
- Clevers, J.G.P.W. 1989. The application of a weighted infrared-red vegetation index for estimating leaf-area index by correcting for soil-moisture. Remote Sensing of Environment 29,25-37.
- Van Evert, F.K., Jukema, J.N., Ten Berge, H.F.M. and Van den Berg, W. 2010. Using Reflection Measurements and Modeling to Minimize N Application in Potatoes [available online at <http://a-c-s.confex.com/crops/2010am/webprogram/Paper58591.html>. Accessed 24 April 2012]. ASA/CSSA/SSSA Annual Meetings, Long Beach CA.

Using data management systems to facilitate better nutrient management planning on Irish farms

Mechan, S.^a, Lalor, S.T.J.^b, Shine O.^a, Jordan, P.^c, Wall, D.^b

^aAgricultural Catchments Programme, Teagasc, Johnstown Castle, Co. Wexford, Rep. of Ireland

^bTeagasc, Crops Environment & Land Use Programme, Johnstown Castle, Co Wexford, Rep. of Ireland

^cSchool of Environmental Sciences, University of Ulster, Coleraine, N. Ireland

1. Background & Objectives

The Agricultural Catchments Programme (ACP) uses an innovative geo-computational information management system based around geographical information systems (GIS), for coordinating nutrient management planning on farms. Farm fertiliser planning for nitrogen (N) and phosphorus (P) is mandatory under European Union (EU) Nitrates Directive rules (Statutory Instrument (S.I.) 610 of 2010) in Ireland. This legislation constrains N and P applications of fertilisers on farms. Alongside these legislative constraints, the cost of fertiliser has increased continuously in Ireland since 2000 forcing farmers to re-evaluate their fertiliser input strategies in order to optimise fertiliser usage. To facilitate increased fertiliser use efficiency, the development and use of a farm nutrient management plan (NMP) is one strategy for maximising the return from on- and off-farm fertiliser resources and this has the potential to yield a double-dividend such as protecting the quality of nearby water resources. To date however, developing an NMP for a farm has been a cumbersome task, usually requiring the collection of data from a number of disparate sources, and resulting in complicated and lengthy spreadsheet outputs. The ACP was initiated to evaluate the EU Nitrates Directive regulations in Ireland and has established experimental infrastructure in five small river catchments (c.500 to 1,200 ha) and one larger catchment over karstic bedrock contributing to a spring (2,990 ha) (Fealy et al., 2010; Wall et al., 2011). There are between 35 and 80 farms in each catchment and the ACP integrates research and advice in partnership with farmers and other stakeholders, facilitating productive agriculture within a framework for protecting water quality. This paper discusses the development of a novel prototype farm nutrient data management system which aims to facilitate better farmer buy-in and usability and improved nutrient management practice and to maximise nutrient use efficiency and recovery on farms.

2. Materials & Methods

On the catchment farms, data collection included detailed nutrient application records, farm fertiliser plans, previous nutrient management plans, and physical farm attributes, e.g. number and area of fields, livestock type and number, crop type and area, soil type and soil nutrient status, annual organic manure production. The fields and land management units within each farm were then digitised using ArcGIS 9 ArcInfo version 9.3. A soil census was conducted to develop a spatial representation of the soil P, K (potassium), Mg (magnesium) concentrations, soil pH and lime requirement (LR) for each catchment. Fields were coded spatially to identify soil test sample areas (~2 ha) and related geodatabases were developed. The soil analysis results were retrieved using a laboratory information management system (LIMS) and linked with the geodatabase and nutrient management planning software to develop nutrient management plans. Nitrogen and P balances were calculated for each field/farm area to quantify farm nutrient loading and identify areas at higher risk for nutrient loss to water courses. Farm data collection and the development of new NMPs were facilitated by the ACP advisory team in each catchment. A Nutrient Management Recorder (NMR) was developed to capture nutrient application events on a per field basis. All data collected are stored centrally on a Document Management System (DMS) - MS SharePoint, which provides a secure system that collates the data into a centralised database. These

various farm data can be linked back to their spatial origin (e.g. soil sampling areas) using a structured geodatabase for each catchment.

3. Results and Discussion

The ACP has created a more automated system that not only offers a farmer a NMP but also the facility to create maps representing the numerical data outputted from these plans. Maps can facilitate spatial representations for application rates for individual fields on a whole-farm basis in accordance with a soil census reports (Figure 1 and 2). The ACP also developed a facility to capture day-to-day management events (e.g. fertiliser applications) on every farm within the catchments using a NMR. With such systems in place within the catchments, farmers are better equipped to plan their nutrient management strategies for the future, and also to track their progress and make informed changes to their plans when needed. Better farm nutrient management brings with it many production, economic and environmental benefits, including reductions in fertiliser wastage from over application, cost savings from reduced fertiliser inputs and potential reductions in nutrient losses to water bodies and to the atmosphere. The ACP Advisors have observed that the catchment farmers engage with the nutrient management information to a greater extent when presented spatially (on maps) for their farms and fields. They also have greater confidence that the nutrient management advice administered this way is carried out more accurately and in a more informed manner.



Figure 1. Colour coded spatial representation of soil test P indices for a farm. Also shown are the soil test P concentrations (Morgans' P) for each field.



Figure 2. Crop and soil test specific P fertiliser and slurry application advice for a farm.

4. Conclusions

The development of a geo-computational information management system to collate and manipulate multiple farm nutrient source and geo spatial data sets has enabled farmers, advisors and researchers to fully utilise these data. This technology can be used to overlay many years of soil analysis results enabling researchers and advisors to track temporal changes in soil fertility and nutrient management. It facilitates integration for geospatial analysis and other research against a wide variety of other datasets whilst maximising the integrity of the data.

References

- Fealy R.M., Buckley C., Mechan S., Melland A., Mellander P.-E., Shortle G. and Jordan P. 2010. The Irish Agricultural Catchments Programme: catchment selection using spatial multi-criteria analysis. *Soil Use and Management* 26, 225-236.
- Wall D., Jordan P., Melland A.R., Mellander P.-E., Buckley C., Reaney S.M. and Shortle., G . 2011. Using the nutrient transfer continuum concept to evaluate the European Union Nitrates Directive National Action Programme. *Environmental Science and Policy* 14, 664-674.

Nitrogen surpluses and diffuse water pollution in German agriculture - trends and measures

Nieder, R.

Institute of Geoecology, Technische Universitaet Braunschweig, 38106 Braunschweig, Germany

1. Background and Objectives

Emissions of nitrogen (N) from different sources affect both the hydrosphere and the atmosphere with serious consequences for human health and the environment. While N, particularly nitrate (NO_3^-) emissions from point sources, such as sewage treatment plants, have been significantly lowered in Germany, the reduction of N emissions from diffuse sources, mainly agricultural land, is not yet satisfactory. Since agriculture is the main source for NO_3^- pollution of water resources, there is urgent need for action. According to the Water Framework Directive, all waters in the EU are to reach a „good status“ by 2015. It is expected that the majority of surface and groundwater bodies in Germany will not be able to meet the objective in time, unless additional measures are taken. Nitrogen balances are important indicators which describe the magnitude of potential N losses from farming systems to the environment (Nieder et al., 1995). This study presents the N surplus development in German agriculture from 1950 to 2009 and discusses the existing legal framework. Moreover, it examines measures that could help to reduce NO_3^- pollution.

2. Materials and Methods

The data for calculation of the N balances for Western Germany (Federal Republic of Germany until 1989 and reunified Germany from 1990 to 2009) were drawn from the publications of the Federal Statistical Office (Anonymous 1) and for Eastern Germany (former German Democratic Republic until 1989), data were provided by a scientific institute (Anonymous 2). The procedure of N balance calculation was described in detail by Nieder et al. (2003; 2007).

3. Results and Discussion

In the 1950s the mean N surplus in Germany did not exceed 30 kg N ha^{-1} (Figure 1). During the following decades the N surplus increased continuously and reached a maximum in Eastern Germany in the 1970s, and in Western Germany during the 1980s. The developments were similar in both states until the reunification in 1990. Due to the collapse of collectivized agriculture after 1989, the N surplus in Eastern Germany first decreased drastically, but has reincreased again in the recent two decades due to revival of the agricultural sector. In Western Germany the N surplus has remained almost constant since 1990 and currently amounts to about $100 \text{ kg N ha}^{-1} \text{ y}^{-1}$. The current mean annual N surplus in the whole of Germany amounts to $85 \text{ kg N ha}^{-1} \text{ y}^{-1}$. The cumulative N surplus from 1950 up to now has recently exceeded $4,000 \text{ kg N ha}^{-1}$ (mean for Germany; Figure 2).

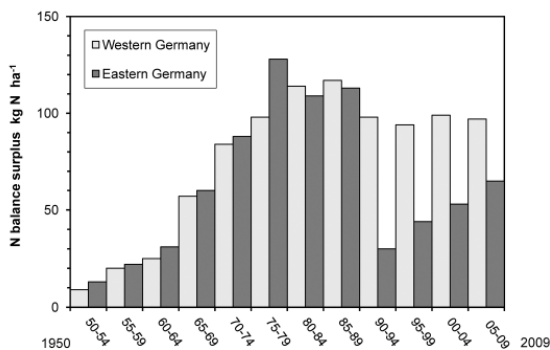

Figure 1: N surpluses in Germany 1950-2009 (Adapted from Nieder et al., 2007)

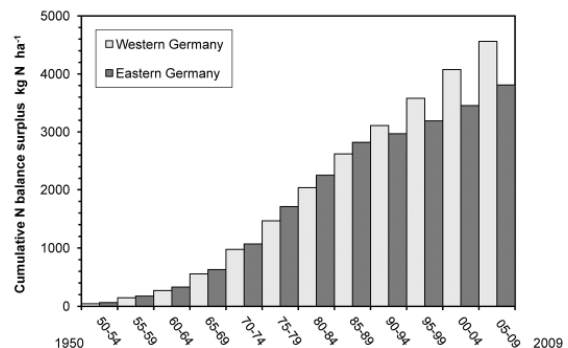

Figure 2: Cumulative N surpluses in Germany (Adapted from Nieder et al., 2007)

Table 1 shows the annual N surpluses for the federal states 2000-2004. The highest N surpluses of more than 80 kg ha⁻¹ N y⁻¹ were calculated for Northrhine Westphalia, Lower Saxony, Bavaria and Schleswig-Holstein. The major reason for the high N surpluses is more intensive animal husbandry compared to the other states. In parts of these states NO₃⁻ concentrations in groundwater are currently still increasing. Comparison of the N surplus per unit agricultural area in the EU 15 states (Nieder and Benbi, 2008) shows an extremely high value for the Netherlands (>250 kg N ha⁻¹ y⁻¹), high values for Belgium (140 kg N ha⁻¹ y⁻¹), Denmark (110 kg N ha⁻¹ y⁻¹), Luxemburg (95 kg N ha⁻¹ y⁻¹) and Germany (85 kg N ha⁻¹ y⁻¹), while they are around (Ireland and Finland) or below 50 kg N ha⁻¹ y⁻¹ in the other countries (UK, Greece, France, Italy, Spain, Portugal, Austria and Sweden.

Table 1: Nitrogen surplus (kg N ha⁻¹ y⁻¹) in German federal states 2000-2004 (Nieder et al., 2007)

Federal state	N surplus kg N ha ⁻¹ y ⁻¹	Federal state	N surplus kg N ha ⁻¹ y ⁻¹
Baden-Wuerttemberg	75	Schleswig-Holstein	162
Bavaria	80	Brandenburg	35
Hesse	69	Mecklenburg-W. Pommerania	55
Lower Saxony	135	Saxony	65
Northrhine-Westphalia	141	Saxony-Anhalt	73
Rhineland-Palatinate	28	Thuringia	43
Saarland	3		

4. Conclusions

Continuing high N surpluses and NO₃⁻ accumulation in groundwater and surface waters in some regions of Germany indicate that it is necessary to examine to what extent existing regulations need to be revised and the implementation of existing instruments is to be improved. There is a wide spectrum of precautionary measures ranging from restrictions on the regional density of livestock to nitrogen taxes/quotas. In Germany the Fertilizer Ordinance is the key ordinance which regulates the amounts of nutrients applied per unit area. It was recently revised in view of implementing the EU Nitrate Directive into German legislation. According to the currently valid provisions of the Ordinance, the spreading of organic nitrogen from animal excretions is usually limited to 170 kg N ha⁻¹ y⁻¹. Under certain conditions, the ordinance permits spreading of 230 kg N ha⁻¹ y⁻¹ from animal manure on intensive grassland, temporary grassland and field grass. However, there are several legal loopholes such as toleration of high amounts of “unavoidable” N emissions due to storage and application of animal manures, extra mineral N fertilizer application in cereals (e.g. late top dressing) and N application after incorporation of cereal straw. These legal parameters allow scope for surplus N in soils and the risk of NO₃⁻ leaching into waters. A first step must be therefore to improve the current Ordinance and new provisions must be examined in view of their efficiency.

References

- Anonymous (1): Statistisches Bundesamt, Land- und Forstwirtschaft: Fachserie 3, Reihe 1, und Produzierendes Gewerbe, Fachserie 4, Reihe 8,2, Jahrgänge 1950 bis 2009.
- Anonymous (2): Zentralinstitut für Physikalische Chemie, Rudower Chaussee 5, 12489 Berlin.
- Nieder, R. and Benbi, D.K. 2008. Carbon and Nitrogen in the Terrestrial Environment. Springer, 430 p.
- Nieder, R., Kersebaum, K.C. and Richter, J. 1995. Significance of nitrate leaching and long-term N immobilization after deepening the plough layers for the N regime of arable soils in N.W. Germany. *Plant and Soil*, 173:167-175.
- Nieder, R., Köster, W., Dauck, H.P., Brinkmann, S. 2003. Nährstoff-Überschüsse in Deutschland von 1950 bis 2000: Quellen, Senken und Wirkungen auf die Umwelt. I. N-Überhang der Landwirtschaft. *Landnutzung und Landentwicklung*, 44:172-178.
- Nieder, R., Köster, W. and Kersebaum, K.C. 2007. Beitrag der Landwirtschaft zu diffusen N-Einträgen. *WasserWirtschaft* 1-2, 53-57.

Monitoring surface drains in the Dutch peat region for estimating nitrogen leaching to ditches

Hooijboer, A.E.J.^a, Buis, E.^a

^a RIVM – National Institute for Public Health and the Environment, Bilthoven, The Netherlands.

1. Background & Objectives

Fen meadows (lowland peat) are found in the western and northern part of the Netherlands. They are low lying, have shallow groundwater levels and are transected by numerous shallow ditches (Van Beek, 2007). Fen meadows often have low infiltration rates due to the consistency of the peat and locally experience upward seepage.

Nitrogen leaching from agricultural sources is not expected to reach deeper groundwater. Instead, excess nitrogen will be transported to small ditches, connected to regional surface water. This is confirmed by the fact that the Drinking Water standard of 50 mg NO₃/l is never exceeded in groundwater, while threshold values for nitrogen in surface water often are (Hooijboer et al., 2012).

Since 1992, the National Institute for Public Health and the Environment (RIVM) monitors the effects of the Dutch mineral policy on the quality of the upper groundwater on farmlands in the Minerals Policy Monitoring Programme (LMM) (Zwart et al., 2008). The LMM monitors both farm management and on-farm water quality on commercial farms.

Since 1995, leaching of nitrogen in the peat region was quantified by monitoring the upper groundwater and ditchwater concentration. In 2006, the LMM started a pilot-project in which surface drains are sampled as well in order to estimate the leaching of nitrogen to ditch water. The objective of this paper is to study the importance of the different flow paths on ditch water quality

2. Materials & Methods

Groundwater, surface drain water and ditch water were monitored on eight dairy farms on peat soils. The farms have on the average two cows per hectare. Samples were taken between November and May when water is discharged to the ditches. The results are averaged per farm per season.

Per farm, 16 randomly selected samples were taken from the upper metre of groundwater by drilling temporary holes, as described by Fraters et al. (2008). Per farm, 8 sampling points for ditch water were selected. Samples from surface drains, 16 per farm, were taken at the outlet to the ditch. Both ditches and surface drains were sampled four times a year; groundwater was sampled once.

The individual samples were mixed into composite samples and analysed on total nitrogen (UV-destruction, photometry), nitrate (ion chromatography) and ammonium (photometry). Organic nitrogen is calculated as total nitrogen minus nitrate and ammonium (nitrite is not analysed).

3. Results & Discussion

It is expected that both groundwater and surface drain water feed the ditches. The total nitrogen concentration in ditchwater is smaller than in both groundwater and surface drain water (table 1). Biological activity and decomposition of inorganic nitrogen into gaseous nitrogen might reduce, the total nitrogen concentration in ditch water in comparison to the two other water types.

The nitrogen compounds in groundwater reflect the anaerobic circumstances: high ammonium and low nitrate. High ammonium concentrations are typical for the Dutch peat regions and they tend to increase with depth (Meinardi, 2005). This indicates that decomposition of the peat causes the high ammonium concentrations, although nitrate reduction to ammonium (DNRA) might play a minor role. Low nitrate concentrations are found in groundwater, as reduction of nitrate is high under anaerobic conditions in organic soils. Surface drain water is more aerobic, and contains less ammonium and more nitrate than groundwater. Relatively, the composition of ditchwater is in between that of groundwater and surface drain water.

Table 1: Average nitrogen components (av), standard error (se) and relative contribution to total-N (rel) for 8 farms and 5 years.

	Surface drain water			Groundwater			Ditch water		
	av	se	rel	av	Se	rel	av	se	rel
Total Nitrogen (mg N/l)	6.2	0.3	100%	11.8	0.7	100%	5.0	0.1	100%
Ammonium (mg N/l)	1.7	0.2	27%	8.1	0.9	69%	2.2	0.1	44%
Nitrate (mg N/l)	1.7	1.1	27%	0.6	0.6	5%	0.8	0.3	16%
Organic Nitrogen (mg N/l)	2.8	0.1	45%	3.1	0.4	26%	2.0	0.1	40%

Surface drain water and ditch water are correlated with respect to total nitrogen ($R^2 = 0.37$, Figure 1), while groundwater and ditch water are uncorrelated ($R^2 = 0.02$). At least a part of the nitrogen concentration in ditchwater can be explained by the surface drains. The total nitrogen concentration in the first meter of the groundwater does not appear to influence the nitrogen concentration of the ditchwater. Additionally, the lack of relations indicates that other processes, such as direct precipitation in the ditches and surface run-off will influence ditch water quality.

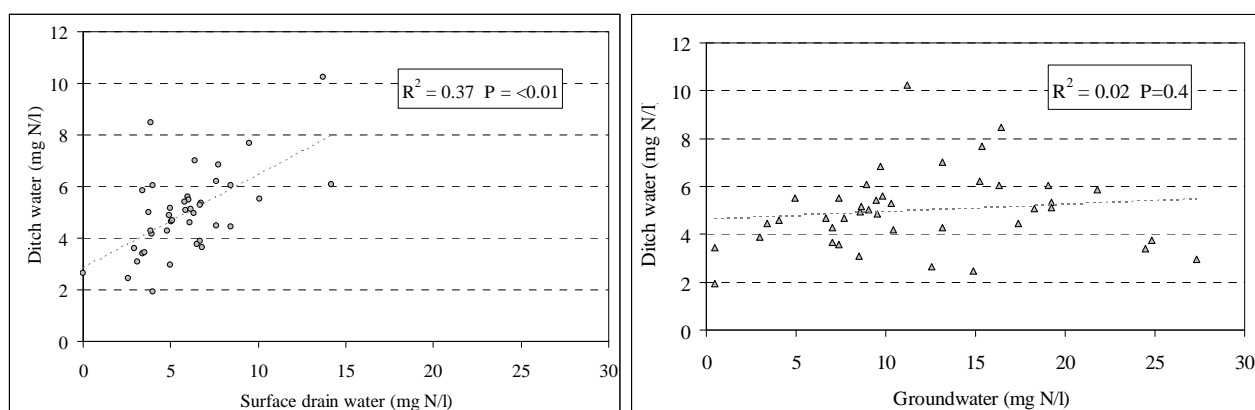
**Figure 1: Correlation between total nitrogen in surface drain water and ditchwater (a) and groundwater and ditch water (b) for 8 farms in 5 year, total 40 observations.**

4. Conclusion

For estimating leaching of nitrogen to ditches, monitoring surface drains seems preferable to monitoring groundwater. Because of the low number of farms in the study, the results are still tentative. From 2011 onwards, this project includes 24 farms. More research will be done in the future to enable better insights into the relation between groundwater, surface drain water and ditch water.

References

- Fraters, B., Reijls, J. W., Van Leeuwen, T. C. & Boumans, L. J. M. (2008) Minerals Policy Monitoring Programme. Results for 2006 on water quality and fertilisation practices within the framework of the derogation monitoring network, RIVM report 680717005.
- Hooijboer, A. E. J., de Klijne, A. (2012) Waterkwaliteit op landbouwbedrijven, Evaluatie Meststoffenwet 2012, RIVM Report, 680123001/2012.
- Meinardi, C.R. (2005) Stroom van water en stoffen door de bodem en naar de sloten in de Vlietpolder, RIVM rapport 500003004.
- Van Beek, C. (2007) Nutrient losses from grassland on peat soil. PhD thesis, Wageningen University, The Netherlands.
- Zwart, M. H., A. E. J. Hooijboer, Fraters, B., Kotte, M., Duin, R.N.M., Daatselaar, C.H.G., Olsthoorn, C.S.M., Bosma, J.N. (2008). Agricultural practice and water quality in the Netherlands in the 1992-2006 period, RIVM.

Role of rotation and nitrogen fertilization on the productive and qualitative response of durum wheat (*Triticum durum* Desf.)

Poma I, Sarno M., Venezia G., Bono G.

Dipartimento dei Sistemi Agro-Ambientali, University of Palermo - Italy.

1. Background & Objectives

A proper soil management requires the implementation of agricultural techniques which can improve and / or sometimes restore the fertility of agricultural land. In this context, crop rotations are particularly important to maintain adequate soil organic matter content and to reduce chemical nutritional intake (Toderi and Giordani, 1983; Lopez-Bellido et al., 2007). From the second half of the twentieth century, there has been a simplification of durum wheat cropping systems, thanks to the availability of new genotypes, resistant to **lodging (setting)** and low-size, which best respond to nitrogen fertilization. Besides, the more frequent use of monocropping has gradually led to a deterioration of the overall soil fertility. The orientation emerged in recent years, based on sustainable development (Bruno et al., 2009; Poma et al., 2000), coupled with the need of processing companies to find the grain with good quality, lead to a modification of existing wheat cropping systems, in order to stabilize the production and to improve the quality parameters of grain (Toderi and Giordani, 1983). In order to better understand the problem, a research has been carried out involving the study of the effects of some cropping systems on the bio-agronomic response of durum wheat and on its grain quality in a typical inland clay hills of Sicily.

2. Materials & Methods

The trial was carried out during 2004/05, 2005/06 and 2006/07 at the Experimental Farm Sparacia (AG – Italy, 37° 37' N 13° 42' E), a representative environment for dry Sicilian durum wheat crops. The layout adopted was a split-plot with three repetitions. The main plots had two crop rotations, durum wheat (P1) and legume (P2), the sub-plots had three levels of nitrogen (N0, N60, and N120 Kg·ha⁻¹). The variety of durum wheat used in the trial was "Simeto", generally used for livestock. Sowing was carried out during the first ten days of December by distributing 350 germinable seeds per square metre in elementary parcels of 15 m². During the preparation tillage, 100 kg·ha⁻¹ of P₂O₅ was applied to all plots, with half of the doses of N. The remaining N was applied as the crop reached the 3-5 leaf-stage. Weeds were controlled with a post emergency application of herbicide for monocotyledons and dicotyledons.

3. Results & Discussion

The climatic conditions of the three-years trial have shown, in the first year of testing, higher rainfall than multi-year average, while in the second and third year the rainfall was lower than the multi-year average, and not favorable to autumn-winter grain-cycle. Temperatures were in line with the long-term average with the exception of the final phase of the crop maturation, especially in the third year, which gave a poor total production.

The ANOVA showed that the response of the crop, to the thesis in study, has been influenced by the effects of individual theses, while among the I order interactions about 50% of the parameters in the study presented statistically clear changes; however, among the II order the changes were not significant (Table 1). The grain production varied mainly due to "years", "precession" and "fertilization" factors. In fact, the highest production was recorded in the first year (3.96 t ha⁻¹), in succession to the legume were higher, compared to monocropping, of 1.1 t ha⁻¹;

theses	Yield (t ha ⁻¹)	1000 seeds weight (g)	Hectolitic weight (kg hl ⁻¹)	Spiklets n° m ²	Protein (% s.s.)
Year (A)	+++	+++	+++	+++	+++
Crop rotation (P)	+++	+++	ns	ns	+
Fertilization (C)	+++	+	ns	++	ns
A X P	++	+	+	+	++
A X C	+	ns	ns	++	+
P X C	ns	ns	ns	ns	++
A X P X C	ns	ns	ns	ns	ns

increased thanks to the fertilization, in the average of three years, from 2.35 (N0) to 3.76 (N120) t ha⁻¹ (Table 2).

The number of ears per unit area has changed according to the level of nitrogen and years. Particularly interesting was the response to the thesis of the cereals ear fertility, which gave highly significant values for both the individual and for the interaction effects "A x P" and "A x C", therefore resulting as the production factor that mostly affected the productive capacity of wheat. The size of the plants showed highly significant values only for main effects. Among the qualitative characteristics, the weight of 1000 seeds was strongly influenced by individual and interaction effects "A x P"; while the hectolitic weight has fluctuated only because of the year and the interaction "A x P". The protein content of grain was influenced by main factors "year" and "precession" and all the interactions of the I order (table 1).

Table 2. Productive and qualitative characteristics

individual effects	Yield (t ha ⁻¹)	1000 seeds weight (g)	Hectolitic weight (kg hl ⁻¹)	Protein (% s.s.)
Year				
2004- '05	3.96 A	60.1 A	84.6 A	11.4 B
2005- '06	2.62 B	59.2 A	84.8 A	12.5 A
2006- '07	2.71 B	51.0 B	81.6 B	10.2 C
Crop rotation				
Durum w.(P1)	2.57 B	58.0 A	83.5 A	11.0 B
Legume c (P2)	3.62 A	55.5 B	83.8 A	11.4 A
Fertilization				
N0	2.35 C	56.8 AB	83.7 A	11.4 A
N60	3.17 B	58.0 A	83.8 A	11.1 A
N120	3.76 A	55.5 B	83.4 A	11.1 A

4. Conclusion

The results showed that the production of grain per unit area has varied according to the year effect, the precession and the nitrogen satisfaction of the grain. The information acquired through this research are particularly interesting, in fact, the production recorded in succession to the legume besides improving the nitrogen use efficiency, during the three years, has also highlighted how, in good years for cereal (the first years of trial), the productions gave more than satisfactory results with N 120 (6.23 t ha⁻¹) and N 60 (4.78 t ha⁻¹) doses so to give great hope for the future of the Sicilian durum wheat growing.

References

- Bruno G., *et al.* 2009. Grano, distribuire l'azoto salvaguardando la redditività. *Terra e Vita* 5: 22-25.
- Lopez-Bellido R. J. *et al.* 2007. Comparative response of bread and durum wheats to nitrogen fertiliser in a rainfed Mediterranean environment. 15th nitrogen workshop. Towards a better efficiency in N use, 494 - 496.
- Poma I., *et al.*, 2000. Risposta produttiva e qualitativa del frumento duro in relazione alla precessione colturale ed alla concimazione minerale. *Atti Congress Int. on: produzioni alimentari e qualità della vita. Sassari* vol I, 416-420
- Toderi G., Giordani G. 1983. L'avvicendamento colturale nella coltivazione del frumento. *L'Informatore agrario* XXXIX (34), 27192-27198.

INDEX OF AUTHORS

Aarts, H. F. M.	428	Balík, J.	242	Bouwman, A. F.	392
Abalos, D.	44, 72, 142, 228	Baratte, C.	315	Brenna, S.	150
Abdalla, M.	358	Barrena, I.	341	Brennan, F.	17
Acutis, M.	66, 114, 150	Barrett, M.	160	Brennan, J.	238
Adomaitis, T.	200	Bartoli, M.	166, 172, 180	Brennan, R.	379
Airasca, A.	144	Batelaan, O.	58, 323	Brenner, D.	21
Aita, C.	184, 226	Battilani, A.	466	Bries, J.	317, 323
Aizpurua, A.	305, 337, 368	Beare, M.	132	Brito, L. M.	194
Alavoine, G.	120	Beaudoin, N.	297, 478	Brown, H.	377
Alfaro, M.	198, 206	Bechini, L.	50	Browne, M.	468
Ali Hossein, R.	196	Beeckman, A.	154	Bru, D.	84
Alluvione, F.	54	Beguín, P.	478	Buchan, D.	136
Almadni, M.	248	Benedetti, P.	144	Buckingham, S.	148
Almendros, P.	62, 162	Bennett, G.	289, 402	Budai, A.	222
Amato, G.	46, 82, 90	Benoit, P.	120	Buegger, F.	140
Anderson, T.	60	Benítez, E.	46	Buffet, D.	476
Angers, D.	32	Berecz, K.	126	Burgers, S.	303
Anthony, S.	148, 439	Bermejo, V.	130	Butler, F.	478
Antille, D.	454	Bernardoni, E.	150	Butterbach-Bahl, K.	415
Anton, A.	126	Berti, A.	64, 266	Byrne, K.	281
Aparicio Tejo, P. M.	295	Bertora, C.	54, 64	Báez Bernal, D.	190, 208, 417
Aquilina, L.	234	Bertrand, N.	32	Böttcher, J.	102
Arbaciauskas, J.	200	Besga, G.	368	Børgesen, C. D.	277, 370
Arbones, A.	104, 108, 178	Betteridge, K.	375	Cabassi, G.	299, 462
Armbruster, M.	74	Biagini, D.	456	Cabral, F.	346
Arregui, L. M.	450, 460	Biau, A.	480	Cahalan, E.	240
Arriaga, H.	279	Biegemann, T.	400	Cai, Z.	176
Arrobas, M.	52, 210	Bienkowski, J.	319	Caldeira, M. D. C.	134
Aschonitis, V. G.	172	Billen, G.	166	Calleja Cervantes, M. E.	295
Aslam, S.	120	Billy, C.	297	Calonge, N.	108
Astrain, J.	458	Bittman, S.	106, 204	Calvete, H.	130
Aubert, A.	234	Bizouard, F.	84	Cameron, K.	19, 275
Aubert, C.	478	Blackshaw, R.	48	Campaña, H.	144
Bacelar, E.	52	Blackwell, M.	170	Cannavo, P.	478
Baggs, E.	220	Blazewicz, S.	11	Cantarella, H.	283, 339
Bailey, J.	364, 366	Blažinkov, M.	291	Cardenas, L.	148, 198, 206
Baillet, A.	478	Bleeker, A.	319	Carozzi, M.	66, 114, 150
Bakken, A. K.	124	Bleken, M. A.	124	Carranca, C.	329
Bakken, L. R.	222	Blind, M.	423	Carroll, P.	374
Balik, J.	425	Bloomfield, J.	372	Carswell, A.	170
Balint, A.	126	Bol, R.	70, 170	Casey, I.	309, 311, 313, 352
Balodis, O.	356	Bolger, T.	348	Castaldelli, G.	172
Balsari, P.	456	Bortolazzo, E.	441, 466	Castelli, F.	174, 331

Castellón, A.	368	Delin, S.	164, 307	Faucheux, M.	234
Castro, J.	190, 208, 417	Della Casa, G.	350	Faverdin, P.	315
Catala-Forner, M. D. M.	325	Delle Vedove, G.	64	Feichtinger, F.	343
Català, M.	482	Delmas, M.	100	Fenech, C.	301
Cavalli, D.	50	Denton, P.	402	Fenton, O.	146, 232, 311, 379
Cellier, P.	319	Deppe, M.	118	Feriel, B. A.	472
Černý, J.	242	Deronzier, G.	100	Fernandes-Silva, A.	52
Chadwick, D.	148, 170, 439	Dexter, M.	335	Ferrante, A.	419
Chambers, B.	321, 439	de Chezelles, E.	28	Ferrara, R. M.	66, 114
Champolivier, L.	28	de Klein, C. A. M.	257	Ferreira, I.	52, 210
Chantigny, M.	32	de La Cruz, A.	130	Fiedler, S.	140
Charpiot, A.	28	de Neve, S.	136, 154, 156	Fierro, A.	218
Chauhan, M.	402	de Paz, J. M.	443	Figueiredo, N.	329
Chen, X. P.	421	de Ruijter, F.	34	Filipović, A.	470
Chisholm, E.	468	de Varennes, A.	68, 144	Fink, M.	128
Chrystal, J.	257	Di Miceli, G.	90	Finzi, A.	462
Cibriain Sabalza, J. F.	295	Di Tommasi, P.	218	Fiorentino, N.	38, 54
Cichota, R.	56, 152	Di, H. J.	19, 275	Firestone, M.	11
Clark, I.	198	Dias, F. L. T.	339	Fisher, T.	21
Claro, M.	52, 210	Dickhofer, U.	415	Flenet, F.	478
Claus, S.	270	Diels, J.	58, 317, 323	Flessa, H.	60, 118
Clough, T. J.	2, 132	Dietrich, G.	184	Fonseca, F.	104, 108, 178, 458
Cocco, E.	64	Dinuccio, E.	456	Forristal, P. D.	238
Cocolo, G.	462	Dittert, K.	182, 270	Fourrie, L.	478
Coffin, A.	84	Dobers, S.	327	Fox, R.	21
Cohan, J.	28, 478	Domange, N.	100	Francis, G.	333
Colombani, N.	172	Dragosits, U.	319	Fraser, T.	333, 377
Condor, R. D.	262	Drouet, J. L.	319	Freer, J.	372
Cooper, J.	248, 445	Dubowski, Y.	15	French, P.	348
Cordovil, C.	68, 144	Dubrulle, P.	478	Frenda, A. S.	90
Correia, C.	52	Duijnisveld, W.	102	Frumau, A.	319
Costa, L.	68	Dupont, A.	478	Frøseth, R. B.	124
Costa, M.	68	Durand, P.	100, 234, 315, 319, 437	Fuccella, R.	299
Costall, D. C.	375	Duval, J.	297	Fuertes Mendizabal, T.	450
Coutinho, J.	134, 346	Duval, R.	478	Gabriel, J. L.	62, 162
Coxon, C. E.	236, 285	Duñabeitia, M.	341	Gaile, Z.	356
Craig, M.	285	Dzeroski, S.	230	Gaillard, J.	448
Czymmek, K.	432	Efretuei, A.	411	Gallardo, M.	212, 214
Daatselaar, C.	362	Elsen, A.	58, 317, 323	Gallejones, P.	337, 368
Dahlin, S.	138	Engström, L.	164, 192, 216	Gan, Y.	48
Dale, A.	366	Erisman, J. W.	392	Gao, X.	48
Dalgaard, T.	319	Ernfors, M.	17, 240	Garcia, H.	130
Daly, D.	285	Espagnol, S.	28, 478	Garcia, L.	44, 130, 228
Damay, N.	448	Estavillo, J. M.	305, 341, 450	Garcia, S.	44, 72, 142, 162, 228
Debeljak, M.	230	Eveillard, P.	28	García Pomar, M. I.	190, 208, 417
Defourny, P.	476	Everard, M.	374	García Ruiz, R.	70
Del Prado, A.	337	Ezquerria, A.	460	García-Garrido, J. M.	46, 82
Delaby, L.	437	Fagnano, M.	38, 54	Garnier, J.	166
Delanote, L.	154	Fagniez, J. P.	478	Garnier, P.	120
Delconte, C. A.	180	Fangueiro, D.	40, 134, 346	Gascoyne, K.	445

Gascuel-Odoux, C.	100, 234, 315, 437	Hatch, D. J.	70, 198	Kampfl, G.	126
Gasser, M.	32	Hawkins, J.	170	Kanazawa, K.	474
Gava, G. J. C.	339	Healy, M.	146, 379	Kasimir Klemedtsson, A.	186, 354
Gebremikael, M.	136	Heger, A.	74	Katamadze, M.	356
Genermont, S.	28, 478	Heinz, F.	122	Kato, N.	474
George, E.	128	Heltai, G.	126	Kedziora, A.	319
Gericke, D.	30	Henault, C.	84	Ketterings, Q.	432
Giacomini, D.	226	Hennesey, D.	232	Khalil, I.	232
Giacomini, S.	184, 226	Herrmann, A.	168, 182, 270	Khalil, M. I.	358
Giambalvo, D.	46, 82, 90	Higgins, S.	36	Khan, A. R.	80
Gierus, M.	415	Hirsch, P.	198	Kidd, J.	445
Gillespie, R.	333	Hoekstra, N.	25, 454	Kindred, D.	452
Giltrap, D.	56	Hoffmann, S.	126	Kira, O.	15
Gimenez, C.	212, 214	Hofmeier, M.	176	Klemedtsson, L.	186
Giussani, A.	150	Hojito, M.	188	Knee, K.	21
Godfray, H. C. J.	384	Holden, N.	404, 409	Komada, M.	474
Gonzalez, I.	130	Horváth, M.	126	Kowalenko, G.	106, 204
Gonzalez, J.	450, 460	Hube, S.	206	Kozlovsky, O.	425
Gonzatto, R.	226	Hubert-Moy, L.	437	Kretia, D.	356
González Moro, M. B.	450	Huerfano, X.	305	Krijger, A.	250
González-Murua, C.	305, 341, 450	Huguet, J.	297	Kristensen, H.	86, 445
Gooday, R. D.	439	Huijsmans, J.	34	Kristóf, K.	126
Gooding, M.	411	Hummelink, E.	98	Krzic, M.	106
Gozdowski, D.	327	Humphreys, J.	232, 309, 311, 313, 352, 404, 409	Kubesova, K.	425
Goñi, J.	460	Humphreys, J.	428	Kulhánek, M.	242
Grant, C.	48	Hunt, D.	106, 204	Kuzmanovski, V.	230
Greene, S.	372	Hutchings, N. J.	319	Kölln, O. T.	339
Greta, R.	122	Hähndel, R.	76	Kücke, M.	118
Griffiths, B.	17	Ibrahim, T.	146	Lafond, G.	48
Grignani, C.	54, 64	Ina, K.	116	Laidlaw, A. S.	366
Grizzetti, B.	166	Iqbal, A.	120	Laini, A.	180
Groot Koerkamp, P. W. G.	287	Irigoyen Iriarte, I.	295	Lalor, S.	25, 281, 454, 486
Groot, J. C. J.	287	Jahangir, M. M. R.	160, 232, 236	Lammel, J.	222
Guichard, L.	478	Janjo, D. H.	423	Lanigan, G.	19, 146, 281, 379
Gustafson, A.	21	Jean-Pierre, G.	472, 476	Lantinga, E.	92, 110, 287
Guzman Bustamante, I.	76	Jeuffroy, M.	478	Lasa Larrea, B.	295
Gyarmati, B.	126	Jhurreea, D.	198	Lassaletta, L.	166
Gyldenkaerne, S.	262	John, V.	423	Laughlin, R.	17, 19, 25, 36, 148, 240
Gómez Muñoz, B.	70	Johnes, P.	23, 170	Laurent, F.	478
Hackett, R.	88, 236, 238, 411	Johnson, E.	48	Lazzaroni, C.	456
Hansen, B.	319	Johnston, P.	232, 236	Le Gall, A.	428
Hansen, S.	124	Jones, P. J.	372	Le Roux, C.	448
Harker, N.	48	Jordan, P.	224, 268, 486	Lebender, U.	202, 222
Haroush, D.	15	Jordan, T.	21	Lecomte, X.	134
Harrington, C.	374	Joris, H. A. W.	339	Ledgard, S.	272
Harrington, R.	374	Jukema, J. N.	484	Leip, A.	398
Harris, D.	439	Justes, E.	478	Leonard, A.	476
Harrison-Kirk, T.	132	Kage, H.	30, 94, 168, 182, 270	Lesschen, J. P.	398
Hartmann, T.	421	Kamper, M.	400	Li, F.	375
Hassanin, M. A.	413			Ligabue, M.	441

Linker, R.	15	Merino, P.	279, 341	O'Doni, N.	372
Lloveras, J.	480	Merot, P.	234	O'Donovan, J.	48
Loddo, S.	266	Mihailescu, E.	352	Oberti, R.	462
Loges, R.	78, 400	Mijangos, I.	480	Oenema, J.	262
Lopes, C.	40	Minet, E.	236	Oenema, O.	98, 262, 398, 406
Lordan, J.	104, 108, 178, 458	Minogue, D.	348	Ohl, S.	168
Loubet, B.	28	Mirjam, H.	122	Olasolo, L.	381
Louro López, A.	190, 208, 417	Misselbrook, T.	44	Olave, R.	148
Luo, J.	272, 335	Misstear, B.	285	Olesen, J. E.	319
Ma, L.	406	Moir, J.	19	Oliveira, C. A.	339
Ma, W. Q.	406	Molenat, J.	234	Olivo, J.	226
MacHet, J.	448	Molnár, E.	126	Olsen, L.	40
MacHet, J.	478	Monaghan, R. M.	257	Orsi, A.	174, 331
Maes, S.	323	Monteagudo Diz, A. B.	112	Osterburg, B.	360
Maglione, G.	218	Montezano, Z. F.	339	Ottaiano, L.	218
Magliulo, E.	319	Montoneri, E.	456	Pacchioli, M. T.	350, 441
Magliulo, V.	218	Morari, F.	64, 266	Pacholski, A.	30, 94, 182
Mahmoud, E. A.	413	Moreau, P.	315, 437	Palmer, I.	140
Malda, J. T.	484	Mori, A.	188	Panzacchi, P.	42
Mano, R.	329	Mori, M.	218	Papió, J.	458
Mantovi, P.	441, 466	Morley, N.	220	Pappa, V.	289, 402
Marchetti, R.	174, 331, 350	Morrissey, A.	301	Pardo, A.	381
Marcoen, J. M.	297	Morvan, T.	28, 478	Pascual, M.	104, 108, 178, 458
Marino, P.	50, 299	Mosca, G.	266	Paterson, E.	220
Marques, P.	329	Mourão, I.	194	Peeters, L.	323
Marstorp, H.	138	Moutinho-Pereira, J.	52	Peklová, L.	242, 425
Martinelli, N.	114	Mueller, C.	17, 240, 358	Pellerin, S.	478
Martinez, M.	325, 482	Muller, T.	421	Pelster, D.	32
Marton, L.	222	Munier-Jolain, N.	84	Pepo, P.	244, 246
Mastrocicco, M.	172	Munro, D.	402	Perazzolo, F.	462
Mathers, G.	468	Murphy, C.	220	Perego, A.	150
Mathieu, D.	297	Murphy, P.	224, 268, 348, 352	Pereira, D.	68
Maturano, M.	445	Myrbeck, A.	186	Pereira, J.	329
Maupas, F.	478	Møller, H. B.	80	Peterson, D. G.	11
Mazeika, R.	200	Müller, C.	2	Peña, M. T.	212, 214
Mazvila, J.	200	Müller, T.	74, 76, 140	Pfab, H.	140
McCabe, T.	238	Necpalova, M.	309, 311, 313	Phelan, P.	309
McCarney, G.	468	Negri, A. S.	462	Philipp, S.	400, 415
McCollum, G.	464	Nelson, D.	464	Philippot, L.	17, 84
McDonald, N.	25	Nett, L.	128	Pierobon, E.	172
McGeough, K.	17, 240	Newell Price, P.	439	Pires, J.	210
McInnes, R.	374	Ni, K.	30, 94	Pla, E.	325, 482
McLeod, C. J. A.	372	Nicolardot, B.	84	Placella, S.	11
Mechan, S.	268	Nicolas, P.	297	Podetta, N.	419
Mechan, S.	486	Nieder, R.	176	Polese, R.	64
Meenken, E.	132	Nielsen, O.	86	Polimeno, F.	218
Melland, A.	224, 268	Nolan, K.	301	Poljak, M.	470
Mellander, P.	224, 268	Nylinder, J.	186, 354	Prazeres, A.	329
Mendes Bastos, L.	184	Nótás, E.	126	Prins, H.	362
Menendez, S.	295, 305, 341	O'Brien, P.	358	Provolo, G.	462

Qin, W.	406	Ruza, A.	356	Spink, J.	411
Quaglietta Chiarandà, F.	54	Rémi, D.	100	Staugaitiene, R.	200
Quakernack, R.	182	Rütting, T.	186	Staugaitis, G.	200
Quemada, M.	62, 162, 293, 445	Sabahi, H.	196	Stavridou, E.	86
Racchetti, E.	180	Sacchi, E.	180	Stenberg, M.	138, 164, 186, 216, 307, 354
Rainer, S.	116	Saia, S.	46, 82, 90	Stipetic, A.	291
Raison, C.	478	Salazar, F.	198, 206	Stockdale, E.	248
Ramat, E.	315	Salemi, E.	172	Ståhl, P.	216
Ramirez, L.	206	Salmon-Monviola, J.	315	Stępień, M.	327
Ramos, C.	443	Samborski, S.	327	Surgy, S.	346
Ramírez-García, J.	293	Sanchez, L.	44, 72, 130, 142, 228	Susenbeth, A.	415
Rana, G.	66, 114	Sanz-Cobeña, A.	44, 72, 142, 162, 228	Suso, M. L.	381
Rao, J.	464	Sartori, L.	266	Sutton, M. A.	253
Rao-Ravella, S.	198	Sasnauskaite, L.	200	Svoboda, N.	270
Rashid, M. I.	287	Scheidl, A.	343	Sylvester-Bradley, R.	264, 289, 402, 452
Raynal, C.	478	Schmatz, R.	184	Szabó, E.	246
Reaney, S.	372	Schmeer, M.	78	Szili Kovács, T.	126
Reau, R.	478	Scholefield, D.	198	Sørensen, P.	80
Recous, S.	120, 478	Schulte, R.	220	Tabley, F.	333
Redžepović, S.	291	Schulte, R.	230	Takahashi, S.	474
Rees, B.	148, 289, 402	Schulz, R.	74, 76, 421	Taube, F.	78, 168, 182, 270, 400, 415
Refaie, E.	413	Schurman, J.	226	Taylor, M.	321, 439
Reijs, J.	362	Schäfer, K.	102	Techen, A.	360
Reubens, B.	154	Sebilo, M.	234	Techow, A.	182
Richards, K.	17, 19, 146, 232, 236, 240	Sedlář, O.	242, 425	Tedd, K.	285
Richards, M.	358	Seeton, D.	106	Tellez, A.	44, 72, 142, 228
Riley, H.	124	Seiz, P.	74	Ten Berge, H.	303
Roberts, A.	275	Selbie, D.	19	Tenorio, J. L.	72
Rochette, P.	32	Senbayram, M.	182, 202, 222, 270	Theobald, M. R.	319
Rochford, N.	281	Sghedoni, L.	174, 331	Thiard, J.	478
Rock, L.	301	Shah, G. M.	92, 110, 287	Thomas, S.	132, 333, 377
Rodrigues, M.	52, 210	Sharp, J.	333, 377	Thompson, R.	212, 214
Roelcke, M.	176	Shaviv, A.	15	Thomsen, I. K.	80
Rohe, L.	60	Shejbalová, S.	242	Thorling, L.	319
Rollett, A.	321	Shine, O.	268, 486	Thorman, R.	289, 402
Romero, E.	166	Shortle, G.	224, 268	Thorup-Kristensen, K.	124
Rosas, A.	206	Sieling, K.	168, 270	Tits, M.	58, 317, 323
Rosato, R.	456	Sikora, S.	291	Tobin, J.	301
Rossetto, R.	339	Skiba, U.	148	Tomas-Navarro, N.	325, 482
Rouxel, M.	234	Smith, J.	358	Tompkins, D.	321
Rudolf, S.	140	Smith, K.	402	Tonon, G.	42
Ruehlmann, J.	128	Smith, P.	358	Topp, K.	148
Rufat, J.	104, 108, 178, 458	Snow, V.	56, 152	Toth, N.	291
Ruisi, P.	46, 82, 90	Soana, E.	166, 172, 180	Trindade, H.	329
Ruiz, L.	234, 315, 437	Soares, J.	283, 339	Trochard, R.	28
Ruiz, M.	293	Sorrenti, G.	42	Tzulker, R.	15
Ruppel, S.	128	Spencer, R.	23	Uribe Etchevarría, M.	144
Ruser, R.	74, 76, 140	Spiess, E.	344		
Rutkowska, A.	96				

Urquiaga, S.	339	Vašák, F.	242	Weiler, D.	184
Vaisvila, Z.	200	Velthof, G.	98, 406	Well, R.	60, 118, 122
Vallejo, A.	44, 72, 130, 142, 162, 228	Ventura, M.	42	Welten, B.	272
Vandecasteele, B.	154, 156	Vermue, A.	84	Weslien, P.	186
Vandenberghe, C.	297	Viaroli, P.	166, 180	Westhoek, H.	398
Vandendriessche, H.	317, 323	Viguria, M.	279	Westhoek, H. J.	392
Vanderborght, J.	58, 323	Villar, J. M.	104, 108, 178, 458	Wetterlind, J.	186
Vandervelpen, D.	317, 323	Villar, L.	178	Weymann, D.	102
van Den Berg, W.	484	Villar, N.	368	Whalley, R.	170
van Den Wyngaert, L.	476	Vinther, F.	277, 370	White, E.	411
van Der Burgt, G.	445	Virginie, P.	100, 478	Wienforth, B.	168, 270
van Der Schans, D. D. A.	484	Visconti, F.	443	Wiesler, F.	74
van Der Schoot, J. R.	303	Vizioso, E.	206	Wiesmeier, M.	415
van Der Weerden, T.	132, 257, 335	Vitale, L.	218	Willekens, K.	154, 156
van Dijk, W.	158, 303	Vitti, A. C.	339	Williams, J.	148, 439
van Evert, F. K.	484	Vogeler, I.	56	Wolf, B.	415
van Geel, W.	158, 484	Von Der Heide, C.	102	Wrage, N.	60
van Grinsven, H. J. M.	392	Vári, E.	244	Yan, M.	404, 409
van Orshoven, J.	58, 323	Vázquez Garcia, N.	381	Yates, C.	23
van Os, E.	423	Wagner, S.	398	Yong, H.	176
van Overtveld, K.	58, 317, 323	Wall, D.	25, 220, 224, 268, 486	Zavattaro, L.	54
van de Vreken, P.	58	Wallenhammar, A.	216	Zebarth, B.	48, 106
Vargas, V. P.	339	Wan, H.	415	Zhang, F.	406, 421
Vargues, A.	329	Wang, F. H.	406	Zhang, W. F.	406
Vasconcelos, E.	40	Waterland, H.	333	Zhu, D.	325
		Watson, C.	17, 25, 36, 240	Zyskowski, R.	333